

## DESCRIPTION

The 5402 and 5422 shock sensors respond to the shock waves of sheet metal that is being cut, sawed, impacted, or drilled. This quality makes it ideal for protecting sheet metal enclosures such as control panels, alarm housings, electrical panels, and telephone junction boxes. No sensitivity adjustments make installation quick and easy.

The 5402 is a lithium battery powered, two-wire sensor. The 5422 is a 4-wire externally powered sensor operating from a 9-24 VDC supply. Both have closed loop outputs.

### Sensor Operation

When the sensor is operational and detects an attack, the sensor alarms, producing three responses:

1. The red LED on the sensor goes on for the period of time the alarm loop is open (2-6 seconds).
2. The loop impedance of the sensor changes from <15 ohms (closed) to >1.0 megaohms (open).
3. This is registered by the alarm panel as an alarm. After an alarm, the sensor automatically resets itself, while the LED extinguishes simultaneously.

## STEP 1 - MOUNTING

Sheet metal enclosures to be protected shall not exceed 2 x 4 x 1 ft. (61 x 122 x 30.5 cm), and shall have a maximum wall thickness of 0.135 inches (0.343 cm). The enclosure must be solid sheet metal, have all sides connected (welded, bolted, etc.), and the lid attached by hinges or screws.

Locate the sensor inside the enclosure on the side wall on or near the hinge. If the hinge runs the length of the side, center the sensor vertically. If the enclosure has multiple hinges, place the sensor next to the hinge nearest the middle of the enclosure (see Figure 1).

### Mounting the Sensor

1. Clean the area where the sensor will be mounted with a 50/50 solution of isopropyl alcohol and water on a clean cloth.
2. Dry the area.
3. Peel the backing from one side of the tape pad. Center the tape pad on the back of the sensor. The tape pad must be flat against the plastic case.
4. Remove the remaining backing paper from the tape pad. Place the sensor against the metal and press firmly.

**NOTE:** Although the 5402 and 5422 have inherent false alarm immunity, a few simple precautions must be observed to prevent false detections.

1. Mount the enclosure and lid securely so that they do not rattle. Use foam pads to eliminate lid rattle.
2. The enclosure should be clear of vibrating objects (i.e., bells, machinery, motors, etc.).

## STEP 2 - WIRING

Remove the cover by depressing the snap in the slot at the end of the sensor and lifting the cover. Connect wires to the terminal block as labeled on the circuit board (see Figure 2).

Run the wires out the terminal block end of the plastic base. Notch out center wire exit in the cover and snap in place.

# Sentrol Models 5402 and 5422

## Metal Enclosure Assault Sensors

UL and ULC Listed

## Installation Instructions

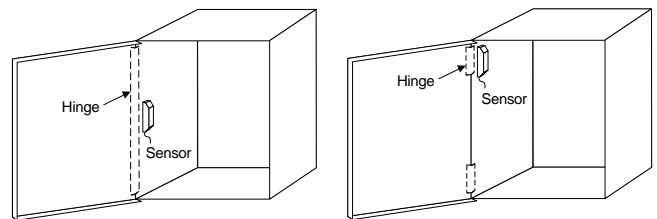
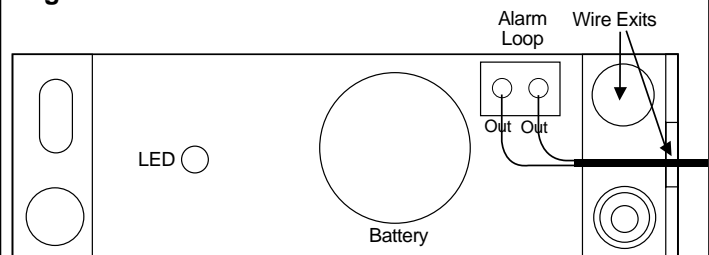

Figure 1. Solid Hinge

Multiple Hinges

Figure 2.



5402 Wiring Guide

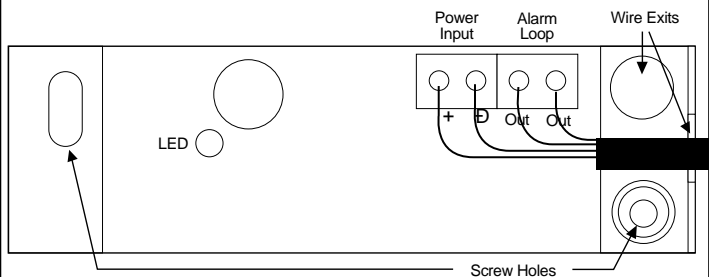

5422 Wiring Guide

## STEP 3 - TESTING

To verify sensor operation, lightly scrape the metal shaft of a screwdriver (8" or larger) back and forth against the metal edge of the enclosure (see Figure 3). The LED should light. Do not use the side with sensor to test as it will be most sensitive. If the sensor range is not sufficient, add another sensor (see Figure 4).

NOTE: Be sure to test the sensor at least annually to ensure proper operation.

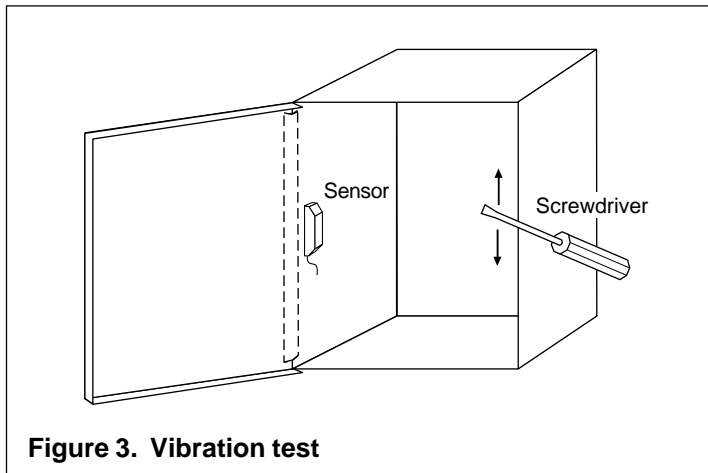

Figure 3. Vibration test

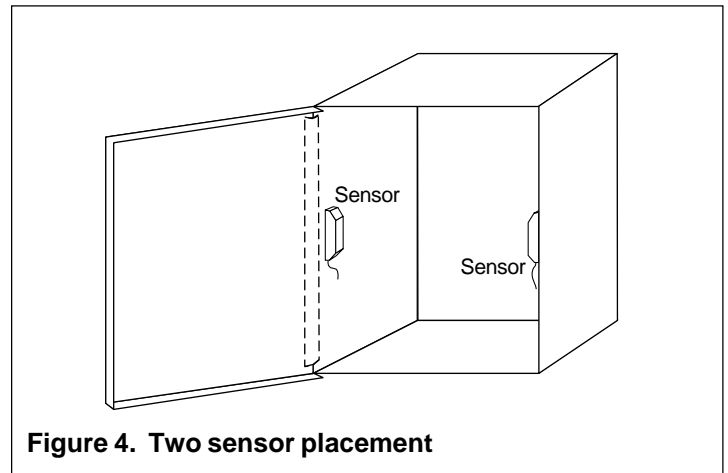
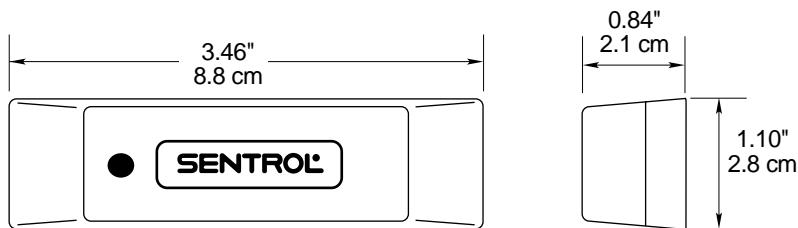

Figure 4. Two sensor placement

## DIMENSIONS



## SPECIFICATIONS

### ALL MODELS

Resistance:	Normal .....	<15 ohms (closed)
	Alarm .....	>1.0 megaohms (open)
Time Open on Alarm .....		2-6 seconds
Operational Voltage (5422) .....		9-24 VDC
Current Draw (5422) .....		15 mA maximum
Number of Leads .....		2 (5402) or 4 (5422)
Maximum Loop Rating .....		24 VDC, 50 mA
Wire Lead Size .....		16-22 gauge
Mounting .....		Tape pad
Dimensions .....		3.46" L x 1.1" W x 0.84" H (8.8 cm x 2.8 cm x 2.1 cm)

### ORDERING INFORMATION

Model Number	Description	Loop Configuration	Color	Listing
5402-W	Lithium battery, 2-wire	Closed loop, NC	Grey	UL/ULC
5422-W	External power, 4-wire	Closed loop, NC	Grey	UL/ULC

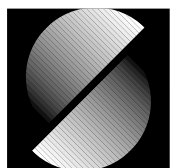

SENTROL

### CORPORATE HEADQUARTERS

12345 SW Leveton Dr., Tualatin, OR 97062  
 Tel: 503.692.4052 Fax: 503.691.7566  
<http://www.sentrol.com>

U.S. & Canada: 800.547.2556

Technical Service: 800.648.7424

FaxBack: 800.483.2495

Sentrol reserves the right to change specifications without notice.

©1999 Sentrol

G-3763-0499  
 1030900 Rev A