

2MPx and 4MPx IP Turret IR Cameras

Series 3 IP Open Standards Cameras

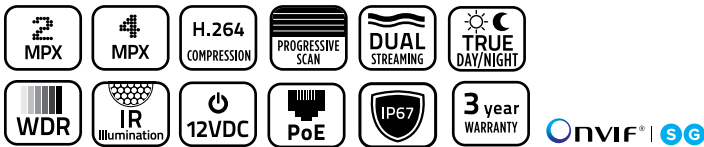

OVERVIEW

TruVision® IP Megapixel Turret IR Cameras by Interlogix bring high-definition images to the mass video surveillance market. With 2MPx or 4MPx resolution options, these cameras provide flexibility for a wide variety of applications.

The IP Megapixel Turret IR Cameras are also designed to adhere to ONVIF® Profile G and S open communication standards and support a CGI command set for simple integration into IP systems.

STANDARD FEATURES

Video

- 2MPx or 4MPx resolution options
- H.264 compression technology with dual-streaming capability
- 2.8mm and 4mm (on select models) fixed lens
- ONVIF Profile G and S open communications standards compatibility

Video Enhancement

- Hallway view, ROI (Region of Interest)
- Real-time video streaming up to 1080p resolution
- WDR 120db
- True D/N functionality and infrared illuminators
- 98 ft. (30m) IR range - with on/off settings

Video Alarms

- Integrated Motion Detection, Tamper proof and Privacy masking
- Advanced Cross line and Intrusion detection

Installation and Environment

- IP67 Environmental rating
- TruVision Device Manager software to access newly added system devices
- Mounting adapter plate

Warranty





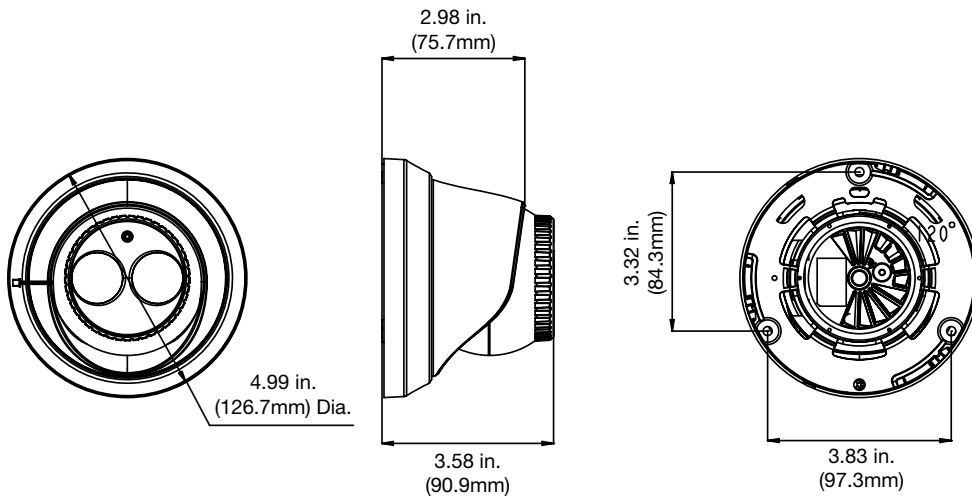

- 3-year warranty

Dimensional Diagrams

TVT-5301, TVT-5302, TVT-5303, TVT-5304, TVT-5305, TVT-5306, TVT-5307 Turret Camera (mounting adapter plate included)



Specifications

	PART NO.	TVT-5301	TVT-5302	TVT-5303	TVT-5304	TVT-5305	TVT-5306	TVT-5307
								
Housing		Gray	White	Black	Gray	White	Black	White
Camera	Sensor	1/3" Progressive Scan CMOS						
	Resolution	2MPx			4MPx			
	Day/Night	IR cut filter						
	IP Compression	H.264 / MJPEG						
	Multiple Streaming	Dual Stream						
	Maximum Resolution	1920 x 1080			2688 x 1520			
	Maximum Real-Time Resolution (@fps)	1920 x 1080 @ 25/30 fps						
	Video Bit Rate	256 Kbps - 16 Mbps						
	Wide Dynamic Range	WDR (120 dB)						
	Digital Noise Reduction	3D-NR						
	Minimum Illumination	0.01 lux @ f1.2, AGC On; 0 lux with IR						
	Digital S/N Ratio	50 dB (AGC Off)						
	Auto Exposure (shutter)	1/3 s to 1/10,000 s						
	Lens	2.8mm @ 2.0						4mm @ 2.0
Focus	Fixed							
IR Range	98 ft. (30m)							
Network	Ethernet Port	1 RJ45 10/100 Mbps auto-negotiate						
	Network Protocols	TCP/IP, HTTP, DHCP, DNS, DDNS, RTP, RTSP, PPPoE, SMTP, NTP, SNMP, HTTPS, FTP, 802.1x, Qos, IPv6						
Local Storage	Media	N/A						
	Capacity	N/A						
Audio	Input	N/A						
	Output	N/A						
	Audio bit rate (protocol)	N/A						
Camera Alarms	Intelligence	Motion Detection, Tamper Proof, Privacy Mask, Dual VCA, Intrusion Detection, Cross Line, Hallway View, ROI						
	Input/Output	N/A						
Interoperability	Standard	ONVIF® (Profile G/S), PSIA, CGI						
Display	Display Mode	Flipped horizontally (up/down), vertically (right/left) or centered, Hallway view, ROI (Region of Interest)						
	On Screen Display (OSD)	Text overlay						
Electrical/Mechanical	Voltage Input	12VDC, PoE (IEEE802.3-af)						
	Power Consumption	7.5W						
	Current	0.625A						
	Auxiliary Output	N/A						
	Dimensions	5 x 3.84 in. (127 x 97.5mm)						
	Weight	1.21 lbs. (548g)						
Environmental	Storage Temperature	-22°F~-140°F (-30°C~60°C)						
	Operating Temperature	-22°F~-140°F (-30°C~60°C)						
	Environmental Rating	IP67						
	Vandal Rating	N/A						
Regulation	Compliance	FCC, CE, UL, WEEE, RoHS, REACH						

2MPx and 4MPx IP Turret IR Cameras

Series 3 IP Open Standards Cameras



Ordering Information

TVT-5301	TruVision® IR Fixed Lens Turret Camera, 2MPx, True D/N, WDR, 30M IR, 2.8mm, PoE (802.3-af)/12VDC, IP67, Gray
TVT-5302	TruVision IR Fixed Lens Turret Camera, 2MPx, True D/N, WDR, 30M IR, 2.8mm, PoE (802.3-af)/12VDC, IP67, White
TVT-5303	TruVision IR Fixed Lens Turret Camera, 2MPx, True D/N, WDR, 30M IR, 2.8mm, PoE (802.3-af)/12VDC, IP67, Black
TVT-5304	TruVision IR Fixed Lens Turret Camera, 4MPx, True D/N, WDR, 30M IR, 2.8mm, PoE (802.3-af)/12VDC, IP67, Gray
TVT-5305	TruVision IR Fixed Lens Turret Camera, 4MPx, True D/N, WDR, 30M IR, 2.8mm, PoE (802.3-af)/12VDC, IP67, White
TVT-5306	TruVision IR Fixed Lens Turret Camera, 4MPx, True D/N, WDR, 30M IR, 2.8mm, PoE (802.3-af)/12VDC, IP67, Black
TVT-5307	TruVision IR Fixed Lens Turret Camera, 4MPx, True D/N, WDR, 30M IR, 4mm, PoE (802.3-af)/12VDC, IP67, White

Accessories

TVD-BB3	TruVision Dome Back Box
TVD-BB3A	TruVision Dome Angled Back Box
TVD-CB3	TruVision Dome 3-Inch Cup Base (use w/TVD-IP, TVD-SNB, TVD-PPB)
TVD-SNB	TruVision Dome Swan Neck Bracket (use w/TVD-CB5A, TVD-CB3, TVD-CB2, TVW-DVM)
TVD-SNB-BB	TruVision TVD-SNB Back Box, 4-directional Conduit, Indoor & Outdoor
TVD-M2-WM	TruVision Dome Wall Mount (use w/TVD VF Domes)
TVD-M-CMA	TruVision Corner Mount Adapter (use w/TVD-SNB, TVC VF/Motor Lens IP Bullet Cameras and TVD-HD-TVI/Analog VF Bullet Cameras)
TVD-M-PMA	TruVision Pole Mount Adapter (use w/TVD-SNB, TVC VF/Motor Lens IP Bullet Cameras and TVD-HD-TVI/Analog Bullet Cameras)
TVD-PPB	TruVision Dome Pendant-Mount Bracket (use w/TVD-CB5A, TVD-CB3, TVD-CB2, TVW-DVM)



interlogix.com

Specifications subject to change without notice.

© 2017 United Technologies Corporation.
All rights reserved.

All trademarks are the property of their respective owners.
Interlogix is part of UTC Climate, Controls & Security,
a unit of United Technologies Corporation.

2017/11 (GSP-2464)