



Ranger 8900DL/DLX

Installation Manual

RANGER 8900DL/DLX
DOWNLOADABLE CONTROL COMMUNICATOR
INSTALLATION MANUAL

TABLE OF CONTENTS

1. TABLE OF CONTENTS.....	P.1
2. GENERAL DESCRIPTION	P.2
3. STANDARD AND OPTIONAL PARTS LIST	P.2
4. PARTS DIAGRAM	P.3
5. TERMINAL DRAWING AND SPECIAL NOTES.....	P.4
6. TERMINAL DESCRIPTION.....	P.5
7. HOW TO PROGRAM THE RANGER 8900DL/DLX.....	P.6
8. KEYPAD PROGRAMMING EXAMPLES.....	P.7
9. #8950 PROGRAMMER EXAMPLE.....	P.7
10. REQUIRED PROGRAMMING INSTRUCTIONS.....	P.8
11. PROGRAMMING WORK SHEETS.....	P.9-11
12. COMMUNICATOR FORMAT SELECTION GUIDE.....	P.12
13. OPTIONAL PROGRAMMING INSTRUCTIONS.....	P.13-25
14. DOWNLOAD PROGRAMMING INSTRUCTIONS.....	P.25
15. GENERAL OPERATING INSTRUCTIONS.....	P.26-28
16. KEYPAD OPERATION.....	P.29
17. UNDERWRITERS LABORATORIES REQUIREMENTS.....	P.30
18. TYPICAL FIRE INSTALLATION LAYOUT.....	P.30
19. LOCAL TELEPHONE COMPANY INTERFACE INFO.....	P.31
20. SPECIFICATIONS & WARRANTY.....	P.32

CADDX-CADDI CONTROLS, GLADEWATER, TEXAS 903-845-6941

RANGER 8900DL/DLX INSTALLATION MANUAL

General Description

The Caddx Ranger 8900DL/DLX is a versatile 8 zone security control with a built-in 16 channel digital communicator. Its microcomputer design gives some of the most versatile, yet easy to use features in the industry today. Each of the six burglary zones can be programmed to be one of seven different types including 24 Hour, Interior Follower, and Day zone. Each zone is individually annunciated and can be bypassed from the keypad.

Read the **OPERATORS MANUAL** before you begin the installation for the best overall description of how the Ranger 8900DL/DLX functions. After installation of the security system complete the information on page 1 of the operators manual and explain the system operation to all security system owners/operators.

Standard Parts List.

The Ranger 8900DL/DLX is shipped with the parts listed below included.

QUANTITY	PART DESCRIPTION	PART NO.
1	MASTER CONTROL PANEL	8905DL
1	REMOTE KEYPAD (WITH 8900DL)	8901
1	DELUXE BACKLIT KEYPAD (WITH 8900DLX)	8911
1	EEPROM MEMORY CHIP	8910
1	16.5 VAC, 25VA TRANSFORMER	T-1625
8	3.3K, 1/2 WATT E.O.L. RESISTORS	EOL-33
1	INSTALLATION MANUAL	IM-8900DL-C
1	OPERATORS MANUAL	OM-8900

Optional Parts List.

The following parts are available for use with the Ranger 8900DL/DLX.

PART DESCRIPTION	PART NO.
DOWNLOADING SOFTWARE PACKAGE	DL-900
LCD ALPHA NUMERIC KEYPAD	9050
PROGRAMMER WITH DIGITAL NUMERIC DISPLAY	8950
4 WIRE CONNECTOR FOR AUXILIARY OUTPUTS	8920
12VDC 6AH BATTERY	B-1260
END OF LINE DEVICE FOR U.L.985 FIRE ZONE	EOL-34UL

PARTS DIAGRAM

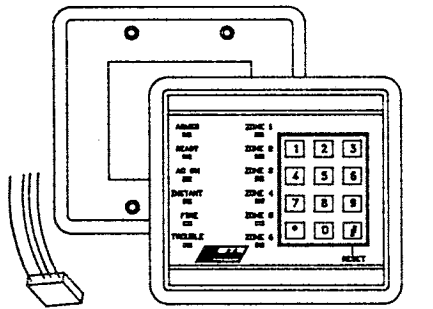
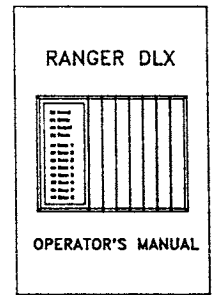
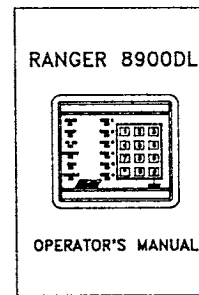
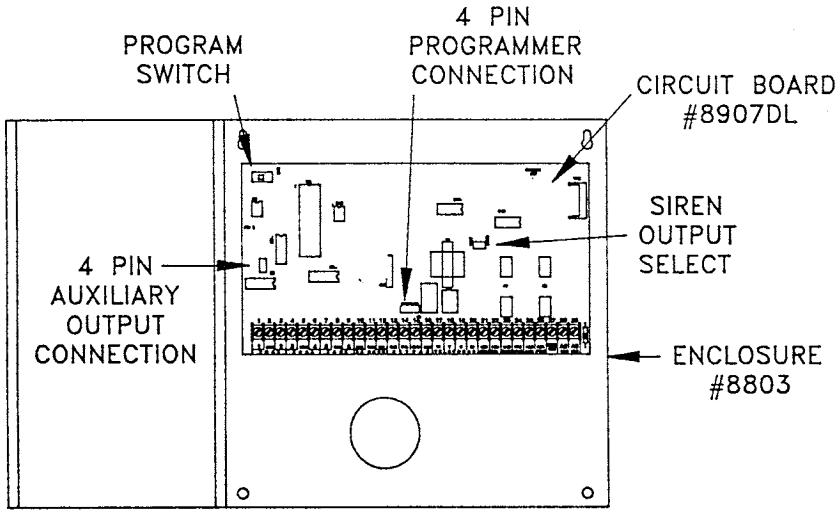

#8901 KEYPAD AND BACKBOX (WITH 8900DL)

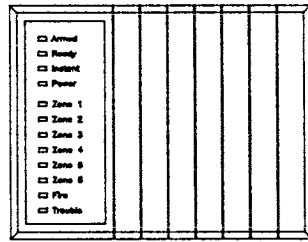

#8911 DELUXE KEYPAD (WITH 8900DLX)



HARDWARE PACK

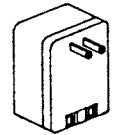

TRANSFORMER #T-1625

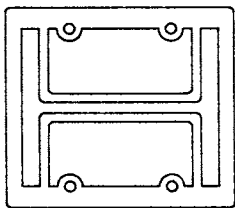

KEYPAD FLUSH MOUNT KIT #8889 (OPTIONAL)

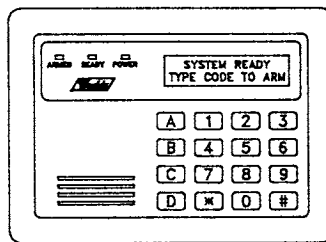

#9050 LCD KEYPAD (OPTIONAL)

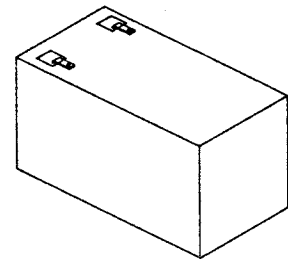

BATTERY #B-1260 (OPTIONAL)

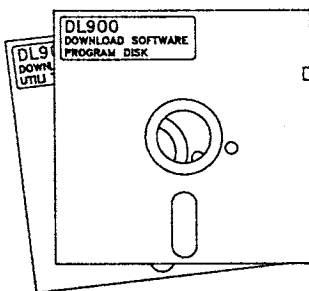

SOFTWARE PACKAGE #DL900 (OPTIONAL)

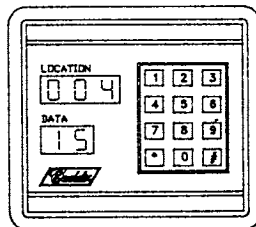

PROGRAMMER #8950 (OPTIONAL)

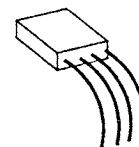

4 WIRE CONNECTOR FOR AUX OUTPUT #8920 (OPTIONAL)

TERMINAL DRAWING AND SPECIAL NOTES

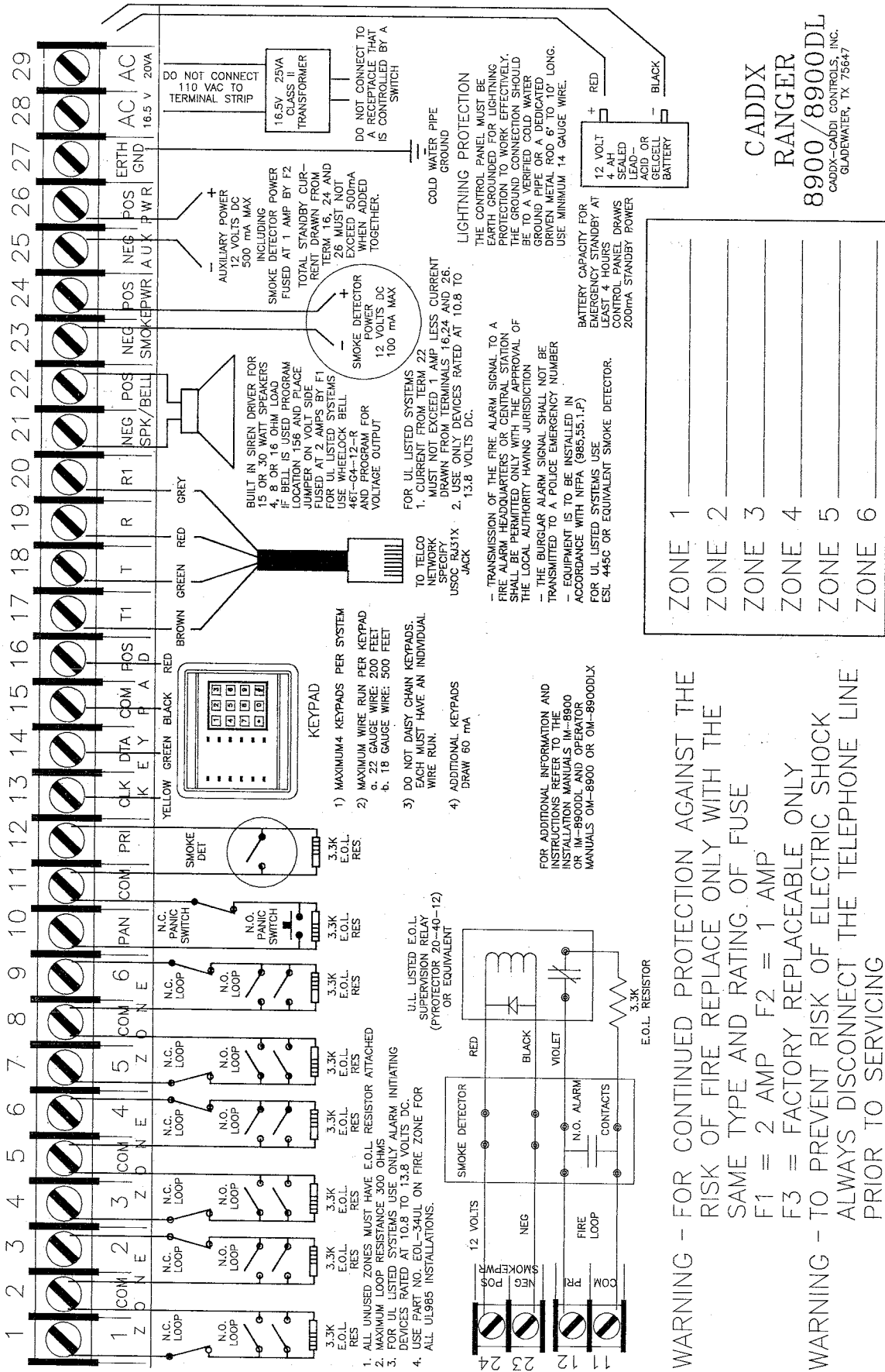

**CADDX
 RANGER
 8900/8900DL**
 CADDX-CADDI CONTROLS, INC.
 GLADEWATER, TX 75647

ZONE 1
ZONE 2
ZONE 3
ZONE 4
ZONE 5
ZONE 6

TERMINAL DESCRIPTION

TERMINAL NO.	DESCRIPTION
1	Connect one side of zone 1 loop. The other side of loop to common terminal 2. An open or a short causes alarm.
2	Common (-) Terminal.
3	Connect one side of zone 2 loop. The other side of loop to common terminal 2. An open or a short causes alarm.
4 - 9	See Terminal Drawing and repeat the above sequence for zones 3-6.
10	Connect one side of the 24 hour panic/hold-up loop to this terminal. The other side of loop to common terminal 11. An open a or short causes alarm.
11	Common (-) Terminal
12	Connect one side of the Fire loop. The other side of loop to terminal 11. Short causes alarm. Open causes Fire Trouble. Use optional part #EOL-34UL for U.L. 985 installations.
13,14,15,16	Connect keypad wires as follows; yellow to terminal 13, green to terminal 14, black to terminal 15, red to terminal 16. 200 ft. maximum run with 22 gauge wire, 500 ft. maximum run with 18 gauge wire. Home run cable to each keypad.
17	(T1) House Telephone Tip (brown).
18	(T) Telephone Tip (green).
19	(R) Telephone Ring (red).
20	(R-1) House Telephone Ring (grey).
21(-)& 22(+)	Siren driver output to speaker(s), (speaker rating should be 15 watt at 8 or 16 ohm, or 30/40 watt at 4, 8, or 16 ohms). If siren driver disable is selected in location 156, output becomes voltage output, 12VDC, 1 Amp maximum load.
23(-)& 24(+)	Smoke detector power 12VDC, 100 mA maximum (For those jurisdictions which allow the Fire zone to be used as a Fire zone).
25(-)& 26(+)	Auxiliary power, 12VDC, 500 mA maximum (400 mA for U.L. installations).
27	Earth Ground, connect to a cold water pipe or 6 to 10 foot driven rod.
28 & 29	AC input, connect a 16.5V 25 VA, Class II U.L. approved transformer (included).
Battery leads	Standby battery leads black(-) and red(+) connect to a 12VDC lead acid rechargeable battery. Do not connect to a dry cell battery.

PROGRAMMING

The 8900DL/DLX can be placed into the "Program" mode by any one of the three following methods, or can be downloaded from a DOS based PC.

1. Slide the Program/Run switch from the run position (left) to the program position (right).
2. Enter the 4 digit "Go To Program" code which must have been entered into locations 180-183 previously. At initial power-up there is no code in these slots and the 8900DL/DLX must be programmed by method 1 above or method 3 below. The 8900DL/DLX must be disarmed for this method of programming. The first digit of this code cannot be the same as the "Quick Arm" code described on page 22.
3. Plug the optional model #8950 programmer into the 4-pin male outlet marked "program" on the Ranger 8900DL/DLX P.C. Board. See figure 3 on page 7.

When the system keypad is utilized for programming (as described by methods 1 and 2 above), the Ranger 8900DL/DLX will be in the program mode and the yellow LED's will display the data in location 000. For easier programming use the "Installers Binary Programming Guide" label which is included with your keypad. The data is displayed using a Binary system. With this system the zone 1 LED equals "1" when illuminated. The zone 2 LED equals "2" when illuminated. The zone 3 LED equals "4" when illuminated. The zone 4 LED equals "8" when illuminated. Thus if the data in location 000 is "9", the LED for zone 1 (=1) and zone 4 (=8) would be illuminated. By adding the two values together (1+8=9), you would determine that the data in location 000 is "9". If the data in location 000 is "6", the illuminated LED's for zone 2 (=2) and zone 3 (=4) would be added (2+4=6) determining the data in location 000 to be "6". If no LED's are illuminated, the location contains a "0". To step from location 000 through 183, press the [#] key. To go to a specific location, press the location number followed by the [#] key. The yellow LED's will then display the data in that location. Data is changed by entering a number "0" to "15" followed by a [*] ("*" = data enter). Review the examples in Figure 2 on page 7.

When using the optional #8950 Programmer, the programming keystrokes will be the same as with the system keypad. The #8950 however, has the ability to display the location and data on the numeric display. See Figure 3 on page 7.

There are three function codes that are used to program the Ranger 8900DL/DLX. These are [2][1][0][#], [2][2][0][#], and [2][3][0][#] and are described below.

- After all the data has been entered into locations 000-183, you must enter the code [2][2][0][#] to permanently place the information into the EEPROM. **IF THIS STEP IS NOT TAKEN, THE DATA IN THE EEPROM WILL NOT CHANGE AND THE RANGER 8900DL/DLX WILL NOT CHANGE CHARACTERISTICS.**
- To change the Ranger 8900DL/DLX data back to the original default values, enter the code [2][1][0][#] to load the data into the RAM memory followed by [2][2][0][#] to load that data into the EEPROM.
- To exit the Program mode after it has been accessed with the four digit "Go To Program" code, enter code [2][3][0][#].

PROGRAMMING EXAMPLE - FIGURE 2

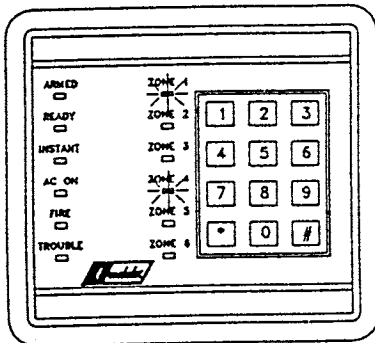

ZONE 1 LED = 1 } DATA = 9
 ZONE 4 LED = 8 }

No LED's illuminated = 0

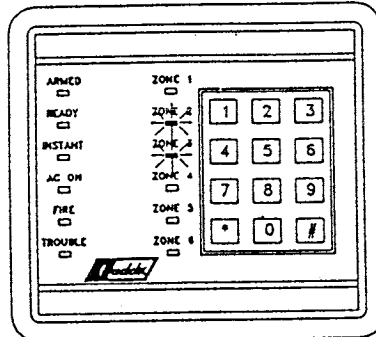

ZONE 2 LED = 2 } DATA = 6
 ZONE 3 LED = 4 }

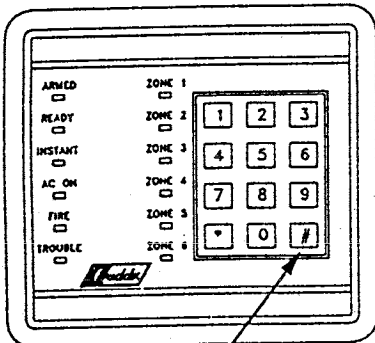

Pressing the # Key will advance to next location, or specific locations can be reached by pressing location number followed by the # Key.

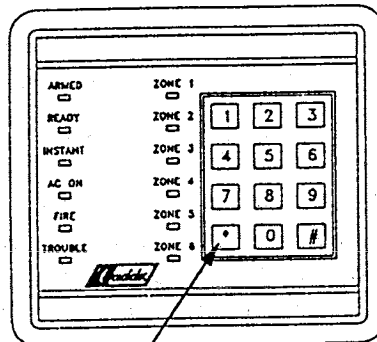

To change or enter data in location shown, enter data and follow by the * Key.

Temporarily place the enclosed "Installers Binary Programming Guide" over the appropriate zone LED's to assist in programming.

INSTALLERS BINARY PROGRAMMING GUIDE
 Refer to instruction manual

- Add numbers beside LEDs to determine data ☐ 1 +
- No LEDs = 0 ☐ 2 +
- Four LEDs = 15 ☐ 4 +
- Once all data entries are complete, press 2-2-0-# to store in EEPROM ☐ 8
- Hex conversions: B=11, C=12, D=13, E=14, F=15

REMOVE AFTER PROGRAMMING

#8950 PROGRAMMER - FIGURE 3

Current Location Indicator

1 Thru 0 Data Keys

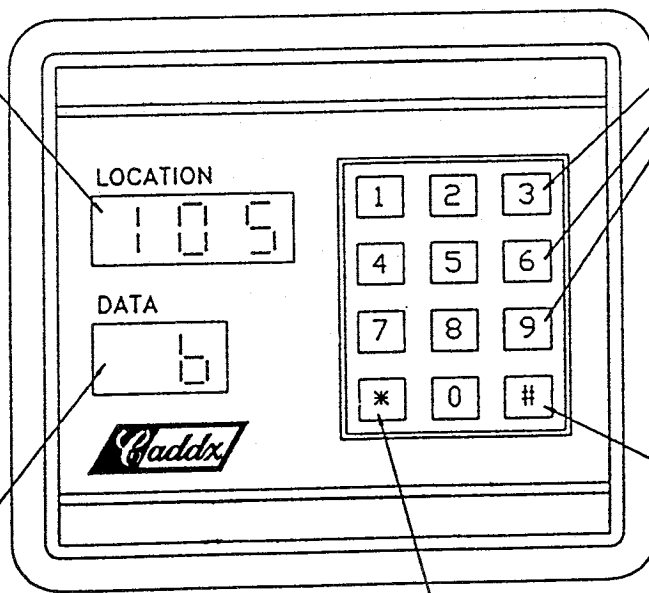

Current Data Indicator

Data Enter/Change key

Location Advance Key

THIS PAGE DESCRIBES ALL THE LOCATIONS WHICH MUST BE PROGRAMMED FOR THE RANGER 8900DL/DLX TO REPORT TO A CENTRAL STATION. ADDITIONAL OPTIONS MAY BE SELECTED BY FOLLOWING THE PROGRAMMING INSTRUCTIONS ON PAGES 13 THRU 23.

LOCATIONS 060-075: PROGRAMMING THE PRIMARY TELEPHONE NUMBER

The primary telephone number is programmed in successive locations beginning with location 060. Any zero (0) within the telephone number must be programmed as a "10". To indicate the end of the telephone number, a "0" must be programmed. Delays of four seconds can be programmed at any point in the telephone number by programming a "13" in the appropriate location. If tone dialing is desired, program a "15" in the location where tone dialing should begin. If the entire telephone number is tone dialing, program a "15 " in location 060. If the telephone number is greater than 16 digits, the primary and back-up telephone numbers can be connected to make one long number by programming a "12" in location 075. Factory default for this location is "0".

LOCATIONS 076-091: PROGRAMMING THE BACK-UP TELEPHONE NUMBER

The back-up telephone number locations are provided to allow the communicator to dial a second number if the primary number does not respond after the number of attempts programmed into location 158 have been tried unsuccessfully. The same number of attempts are made with the back-up number. These locations may also be utilized if the primary telephone number is greater than 16 digits by programming a "12" in location 075. Tone dialing and delay instructions are the same as for the primary number.

LOCATIONS 092-095: PROGRAMMING THE ACCOUNT CODE

The account code is programmed in locations 092-095. If a three digit account code is desired, location 095 must contain a "0". Any zero (0) within the account code must be programmed as a "10" and the communicator will report a zero (0).

LOCATION 096: PROGRAMMING COMMUNICATOR FORMAT

Location 096 contains the communicator format. Consult the instructions for your central station receiver to determine which format is compatible. To select Ademco/Silent Knight Fast, program a "2" in location 096. For Sescoa/Franklin Fast, program a "4" in location 096, and for Radionics 1800HZ/2300HZ Fast with parity and hex capability, program a "9" in location 096. If you need another format, choose from those listed on the format table located on page 12 and program the data in location 096. If location 096 contains a "0", the built-in communicator will be disabled, and the Ranger 8900DL/DLX will function as a local only control.

LOCATIONS 000-059 and 097-183 ARE ADDITIONAL OPTIONAL PROGRAMMING SLOTS TO CHANGE STANDARD DEFAULT COMMUNICATOR AND CONTROL FUNCTIONS FOR SECURITY SYSTEMS WITH NON-STANDARD OR UL REQUIREMENTS. THESE ARE EXPLAINED ON PAGES 13 THROUGH 23.

ARM/DISARM CODES

LOCATION	PAGE	DESCRIPTION	DATA	DATA	DATA	DATA	DEFAULT
0-3	13	USER 1 ARM/DISARM CODE					"1-2-3-4"
4-7	13	USER 2 ARM/DISARM CODE					"15" DISABLED
8-11	13	USER 3 ARM/DISARM CODE					"15" DISABLED
12-15	13	USER 4 ARM/DISARM CODE					"15" DISABLED
16-19	13	USER 5 ARM/DISARM CODE					"15" DISABLED
20-23	13	USER 6 ARM/DISARM CODE					"15" DISABLED
24-27	13	USER 7 ARM/DISARM CODE					"15" DISABLED
28-31	13	USER 8 ARM/DISARM CODE					"15" DISABLED
32-35	13	USER 9 ARM/DISARM CODE					"15" DISABLED
36-39	13	USER 10 ARM/DISARM CODE					"15" DISABLED
40-43	13	USER 11 ARM/DISARM CODE					"15" DISABLED
44-47	13	USER 12 ARM/DISARM CODE					"15" DISABLED
48-51	13	USER 13 ARM/DISARM CODE					"15" DISABLED
52-55	13	USER 14 ARM/DISARM CODE					"15" DISABLED
56-59	13	USER 15 ARM/DISARM CODE					"15" DISABLED

PHONE NUMBERS ACCOUNT CODE AND FORMAT

60-67	8	PRIMARY PHONE NUMBER DIGITS 1 - 8						"0" DISABLED
68-75	8	PRIMARY PHONE NUMBER DIGITS 9 - 16						"0" DISABLED
76-83	8	BACK-UP PHONE NUMBER DIGITS 1 - 8						"0" DISABLED
84-91	8	BACK-UP PHONE NUMBER DIGITS 9 - 16						"0" DISABLED
92-95	8	ACCOUNT CODE						"0" DISABLED
96	8	COMMUNICATOR FORMAT						"0" DISABLED

OPTIONAL CONTROL AND COMMUNICATOR FEATURES

LOCATION	PAGE	DESCRIPTION	DATA	DEFAULT
97	14	ENTRY TIME (10 SECOND INCREMENTS)		"3" 30 SECONDS
98	14	EXIT TIME (10 SECOND INCREMENTS)		"6" 60 SECONDS
99	14	SIREN SHUTDOWN/RECYCLE TIMEOUT (2 MINUTE INCREMENTS)		"4" 8 MINUTES
100	14	ZONE 1 TYPE		"3" ENTRY/EXIT
101	14	ZONE 2 TYPE		"5" INTERIOR FOLLOWER
102	14	ZONE 3 TYPE		"6" INSTANT
103	14	ZONE 4 TYPE		"6" INSTANT
104	14	ZONE 5 TYPE		"6" INSTANT
105	14	ZONE 6 TYPE		"6" INSTANT

COMMUNICATOR CODES

LOCATION	PAGE	DESCRIPTION	CODE	EXTENDED CODE	DEFAULTS
106-107	15	DURESS COMMUNICATOR CODE			"0" DISABLED
108-109	16	AUXILIARY 1 COMMUNICATOR CODE			"0" DISABLED
110-111	16	AUXILIARY 2 COMMUNICATOR CODE			"0" DISABLED
112-113	16	KEYPAD PANIC COMMUNICATOR CODE			"2 - 1"
114-115	16	TAMPER COMMUNICATOR CODE			"0" DISABLED
116-117	16	CHECKSUM ERROR COMMUNICATOR CODE			"0" DISABLED
118	17	CLOSING COMMUNICATOR CODE		MAN NUMBER	"0" DISABLED
119	17	OPENING COMMUNICATOR CODE		MAN NUMBER	"0" DISABLED
120-121	17	ZONE 1 COMMUNICATOR CODE			"3 - 3"
122-123	17	ZONE 2 COMMUNICATOR CODE			"4 - 3"
124-125	17	ZONE 3 COMMUNICATOR CODE			"5 - 3"
126-127	17	ZONE 4 COMMUNICATOR CODE			"6 - 3"
128-129	18	ZONE 5 COMMUNICATOR CODE			"7 - 3"
130-131	18	ZONE 6 COMMUNICATOR CODE			"8 - 3"
132-133	18	HOLDUP/PANIC COMMUNICATOR CODE			"2 - 1"
134-135	18	FIRE COMMUNICATOR CODE			"1 - 1"
136-137	18	AC POWER LOSS COMMUNICATOR CODE			"0" DISABLED
138-139	18	LOW BATTERY COMMUNICATOR CODE			"0" DISABLED
140	19	FIRE TROUBLE COMMUNICATOR CODE		FIRE ZONE	"0" DISABLED
141	19	ZONE BYPASS COMMUNICATOR CODE		ZONE NUMBER	"0" DISABLED
142	19	RESTORE COMMUNICATOR CODE		ZONE NUMBER	"0" DISABLED
143	19	CANCEL COMMUNICATOR CODE		MAN NUMBER	"0" DISABLED

OPTIONAL CONTROL AND COMMUNICATOR FEATURES

LOCATION	PAGE	DESCRIPTION	DATA	DEFAULT
144	19	ABORT COMMUNICATOR CODE		"0" DISABLED
145	20	HOLDUP/PANIC AUDIBLE		"0" AUDIBLE
146	20	ZONE 1 LOOP RESPONSE TIME		"0" 500 MS
147	20	ZONE 2 LOOP RESPONSE TIME		"0" 500 MS
148	20	ZONE 3 LOOP RESPONSE TIME		"0" 500 MS
149	20	ZONE 4 LOOP RESPONSE TIME		"0" 500 MS
150	20	ZONE 5 LOOP RESPONSE TIME		"0" 500 MS
151	20	ZONE 6 LOOP RESPONSE TIME		"0" 500 MS
152	20	HOLDUP/PANIC LOOP RESPONSE TIME		"0" 500 MS
153	20	FIRE LOOP RESPONSE TIME		"0" 500 MS
154	20	NUMBER OF ALARMS FOR SWINGER SHUTDOWN		"0" DISABLED
155	20	AUTO BYPASS/INSTANT ARMING		"0" DISABLED
156	20	SIREN DRIVER/VOLTAGE OUT		"0" SIREN
157	21	L.E.D. EXTINGUISH		"0" DISABLED
158	21	DIAL ATTEMPTS		"8" EIGHT ATTEMPTS

OPTIONAL CONTROL AND COMMUNICATOR FEATURES (CONTINUED)

LOCATION	PAGE	DESCRIPTION	DATA	DEFAULT
159	21	POWER UP CONDITION		"0" LAST CONDITION
160	21	POWER UP DELAY		"0" 60 SEC DELAY
161	21	IMMEDIATE RESTORE BY ZONE		"0" DISABLED
162	21	NO ARMING WITH A ZONE BYPASSED		"0" DISABLED
163	22	QUICKARM DIGIT		"0" DISABLED
164	22	FIRE SIREN CUTOFF INHIBIT		"0" RECYCLES
165	22	DOUBLE LINE EXTENDED		"0" DISABLED
166	22	SIREN/BELL TEST		"0" DISABLED
167	22	RESETTABLE AUXILIARY POWER		"0" FIRE POWER
168	22	EUROPEAN DIALING		"0" DISABLED
169	23	AUXILIARY OUTPUT 1		"2" PANIC
170	23	AUXILIARY OUTPUT 2		"1" FIRE
171	23	AUXILIARY OUTPUT 3		"0" BURG
172	23	AUXILIARY OUTPUT 4		"3" ARMED
173	23	AUXILIARY OUTPUT INVERSION		"0" HIGH GOING LOW
174	24	AC POWER LOSS DELAY		"0" DELAYED
175	24	NUMBER OF RINGS TO ANSWER DOWNLOAD CALL		"8" EIGHT RINGS
176	24	"DOWNLOADING COMPLETE" STANDARD COMMUNICATOR CODE		"0" DISABLED
177	24	"DOWNLOADING COMPLETE" EXTENDED COMMUNICATOR CODE		"0" DISABLED
178-179	24	RESERVED		"RESERVED"
180	24	"GO TO PROGRAM" ACCESS CODE DIGIT 1		"15" DISABLED
181	24	"GO TO PROGRAM" ACCESS CODE DIGIT 2		"15" DISABLED
182	24	"GO TO PROGRAM" ACCESS CODE DIGIT 3		"15" DISABLED
183	24	"GO TO PROGRAM" ACCESS CODE DIGIT 4		"15" DISABLED
184-187	24	RESERVED		"RESERVED"

REMEMBER: AFTER ALL DATA HAS BEEN ENTERED INTO THE APPROPRIATE PROGRAMMING LOCATIONS, YOU MUST ENTER FUNCTION CODE [2][2][0][#] TO PERMANENTLY PLACE INFORMATION INTO THE EEPROM! IF THIS STEP IS NOT TAKEN, THE DATA IN THE EEPROM WILL NOT CHANGE AND THE RANGER 8900 WILL NOT CHANGE CHARACTERISTICS!

THE FOLLOWING LOCATIONS ARE ACCESSIBLE ONLY THROUGH DOWNLOADING

188-195	25	CONTROL PANEL ACCESS CODE										"89000000"
196-203	25	CALLBACK PHONE NUMBER DIGITS 1-8										"0" DISABLED
204-211	25	CALLBACK PHONE NUMBER DIGITS 9-16										"0" DISABLED

LOCATION	PAGE	DESCRIPTION	DATA	DEFAULT
212	25	ANSWERING MACHINE DEFEAT		"0" DISABLED
213	25	LOCAL PROGRAMMING LOCKOUT		"0" NOT LOCKED
214	25	CONTROL PANEL SHUTDOWN		"0" CONTROL ON

DATA	FORMAT	DESCRIPTION
"0"	LOCAL ONLY	THE COMMUNICATOR IS DISABLED
"1"	ADEMCO/SILENT KNIGHT SLOW	1900HZ TRANSMIT 1400HZ HANDSHAKE DOUBLE ROUND PARITY 10 PPS
"2"	ADEMCO/SILENT KNIGHT FAST	1900HZ TRANSMIT 1400HZ HANDSHAKE DOUBLE ROUND PARITY 20 PPS
"3"	SESCOA/FRANKLIN SLOW	1800HZ TRANSMIT 2300HZ HANDSHAKE DOUBLE ROUND PARITY 10 PPS
"4"	SESCOA/FRANKLIN FAST	1800HZ TRANSMIT 2300HZ HANDSHAKE DOUBLE ROUND PARITY 20 PPS
"5"	EXTENDED RADIONICS SLOW	1800HZ TRANSMIT 2300HZ HANDSHAKE DOUBLE ROUND PARITY 20 PPS EXTENDED HEX CAPABILITY
"6"	EXTENDED RADIONICS SLOW	1800HZ TRANSMIT 1400HZ HANDSHAKE DOUBLE ROUND PARITY 20 PPS EXTENDED HEX CAPABILITY
"7"	EXTENDED RADIONICS FAST	1800HZ TRANSMIT 2300HZ HANDSHAKE DOUBLE ROUND PARITY 40 PPS EXTENDED HEX CAPABILITY
"8"	EXTENDED RADIONICS FAST	1800HZ TRANSMIT 1400HZ HANDSHAKE DOUBLE ROUND PARITY 40 PPS EXTENDED HEX CAPABILITY
"9"	EXTENDED RADIONICS FAST WITH PARITY	1800HZ TRANSMIT 2300HZ HANDSHAKE SINGLE ROUND WITH PARITY 40PPS EXTENDED HEX CAPA- BILITY
A ="10"	EXTENDED RADIONICS FAST WITH PARITY	1800HZ TRANSMIT 1400HZ HANDSHAKE SINGLE ROUND WITH PARITY 40PPS EXTENDED HEX CAPA- BILITY
B ="11"	SILENT KNIGHT 4+2 SLOW	1900HZ TRANSMIT 1400HZ HANDSHAKE DOUBLE ROUND PARITY FOUR-TWO 10PPS
C ="12"	SILENT KNIGHT 4+2 FAST	1900HZ TRANSMIT 1400HZ HANDSHAKE DOUBLE ROUND PARITY FOUR-TWO 20PPS
D ="13"	NON-EXTENDED RADIONICS	1800HZ TRANSMIT 2300HZ HANDSHAKE DOUBLE ROUND PARITY 20 PPS HEX CAPABILITY
E ="14"	NON-EXTENDED RADIONICS	1800HZ TRANSMIT 1400HZ HANDSHAKE DOUBLE ROUND PARITY 20 PPS HEX CAPABILITY
F ="15"	ADEMCO/SILENT KNIGHT FAST HEX	1900HZ TRANSMIT 1400HZ HANDSHAKE DOUBLE ROUND PARITY 20 PPS HEX CAPABILITY

LOCATIONS 000-003: PROGRAMMING THE MASTER ARM/DISARM CODE

Locations 000-003 contain master arm/disarm code (user number 1). Location 000 contains the first digit of the code; location 003 contains the fourth digit of the code. THE CODE MUST CONTAIN FOUR (4) DIGITS. The master code can then be used in the run mode to enter arm/disarm codes 1-15 (see page 26, ENTERING AND CHANGING THE MASTER CODE). The factory default is [1]-[2]-[3]-[4].

LOCATIONS 004-007: PROGRAMMING THE ARM/DISARM CODE FOR USER 2

Locations 004-007 contain the arm/disarm codes for user number 2. Location 004 contains the first digit of the code, location 007 contains the fourth digit of the code. THE CODE MUST CONTAIN FOUR (4) DIGITS. To disable a code, program a "15" as the first digit of the code. This code can be changed in the RUN mode using the master code (see page 27, ENTERING AND CHANGING AUXILIARY CODES). The factory default for user number 2 is disabled.

LOCATIONS 008-055: PROGRAMMING THE ARM/DISARM CODE FOR USERS 3-14:

Locations 008-055 contain the arm/disarm codes for user number 3-14. To program these codes follow the instructions for user number 2 corresponding to the following table:

USER NUMBER	LOCATION	COMMENTS
3	008-011	Can be changed in the run mode
4	012-015	Can be changed in the run mode
5	016-019	Can be changed in the run mode
6	020-023	Can be changed in the run mode
7	024-027	Can be changed in the run mode
8	028-031	Can be changed in the run mode
9	032-035	Can be changed in the run mode
10	036-039	Can be changed in the run mode
11	040-043	Can be changed in the run mode
12	044-047	Can be changed in the run mode
13	048-051	Can be changed in the run mode
14	052-055	Can be changed in the run mode

LOCATIONS 056-059: PROGRAMMING THE CODE FOR DURESS OR USER 15

Locations 056-059 contain the arm/disarm code for Duress or for user number 15. Duress capability is enabled by placing a communicator code in locations 106-107. If these locations are left unprogrammed, user number 15 will be a standard arm/disarm code.

LOCATION 097: PROGRAMMING THE ENTRY DELAY TIME

Location 097 contains the number of 10 second increments in the entry delay. The entry delay can be programmed in 10 second increments from 10 to 150 seconds ("1"=10 seconds through "15"=150 seconds). For example, programming a "2" in location 097 will produce an entry delay of 20 seconds. (Note: A "0" entry is treated as the factory default setting of 30 seconds). Programming a "6" in location 097 will produce an entry delay of 60 seconds. Maximum of 40 seconds entry time on all UL-1023 installations.

LOCATION 098: PROGRAMMING THE EXIT DELAY TIME

Location 098 contains the number of 10 second increments in the exit delay. The exit delay can be programmed in 10 second increments from 10 to 150 seconds ("1"=10 seconds through "15"=150 seconds). For example, programming a "2" in location 098 will produce an exit delay of 20 seconds. (Note: A "0" entry is treated as the factory default of 60 seconds). Maximum of 60 seconds on all UL-1023 installations.

LOCATION 099: PROGRAMMING THE SIREN SHUTDOWN/RECYCLE TIMEOUT

Location 099 contains the number of 2 minute increments in the automatic cutoff time. The automatic cutoff time can be programmed in 2 minute increments from 2 to 30 minutes ("1"=2 minutes through "15"=30 minutes). For example, programming a "2" in location 099 will produce an automatic cutoff time of 4 minutes. (Note: A "0" entry is treated as the factory default of 8 minutes). Programming a "6" in location 099 will produce an automatic cutoff time of 12 minutes. Minimum of 4 minutes on all UL-1023 installations. For UL-985 see location 164.

LOCATIONS 100-105: PROGRAMMING THE BURGLARY ZONE TYPES

Locations 100 through 105 contain a number identifying the characteristics of each of the six burglary zones. Location 100 corresponds to zone 1 and location 105 corresponds to zone 6. Each zone will factory default according to the following list:

ZONE NUMBER	DEFAULT CHARACTERISTIC
ZONE 1	ENTRY/EXIT DELAY
ZONE 2	INTERIOR FOLLOWER
ZONE 3	INSTANT
ZONE 4	INSTANT
ZONE 5	INSTANT
ZONE 6	INSTANT

To program zone characteristics other than the default values, program a number from "1" to "7" based on the characteristics found in the following list:

NUMBER	ZONE CHARACTERISTICS DESCRIPTION
"1"	DAY ZONE - A trip on a Day zone will produce an instant alarm when armed and activate the keypad sounder when disarmed.
"2"	24 HOUR - A trip on a 24 Hour zone will produce an instant alarm when the Ranger is armed or disarmed.
"3"	ENTRY/EXIT - A trip will start entry delay. The lack of a trip during exit delay will enable the "Instant" mode if so programmed.
"4"	INTERIOR DELAY - A trip on Interior Delay zone will initiate an entry delay. It will be ignored during exit delay and when disarmed .
"5"	INTERIOR FOLLOWER - Interior zone that follows the delay zones. It is instant during non-delay times. It can be bypassed before arming, or by allowing it to automatically be bypassed in the automatic "Instant" mode.
"6"	INSTANT - Produces an instant alarm when tripped in the armed mode. It is ignored when disarmed.
"7"	24 HOUR SILENT - A trip on a 24 hour silent zone will communicate to the central station when the ranger is armed or disarmed.

IMPORTANT NOTE: WHEN PROGRAMMING THE FOLLOWING COMMUNICATOR CODES, A "10" MUST BE PROGRAMMED IN ORDER TO SEND A ZERO (0).

LOCATION 106-107: PROGRAMMING THE RANGER 8900DL/DLX FOR DURESS CODE CAPABILITY

The Ranger 8900DL/DLX has the ability to report a duress code when the system is armed or disarmed with user code number 15 and a duress communicator code is programmed in locations 106-107. If both locations are "0", the duress capability is disabled and user code number 15 can only be used as a standard arm/disarm code. Location 106 contains the standard digit and Location 107 contains the extended digit. When using 4+2 format the number programmed in location 106 is sent as the second or "ones" digit. The first or "tens" digit is programmed in location 107.

EXAMPLE

If you want the Duress Code to report an eight (8), you program an "8" in location 106 and leave location 107 with a "0". If you were using a 4+2 format and wanted the Duress Code to report an eighteen (18), you would program an "8" in location 106 and a "1" in location 107.

LOCATION 108-109: PROGRAMMING FOR AUXILIARY 1

The Ranger 8900DL/DLX has the ability to report an Auxiliary 1 code and activate the Fire siren each time the [1] and [3] keys are pressed simultaneously on the keypad. The desired reporting code is programmed in locations 108-109. If both locations are "0", the Auxiliary 1 double keypress is disabled. Location 108 contains the standard digit and location 109 contains the extended digit. When using a 4+2 format, the number programmed in location 108 is sent as the second or "ones" digit. The first or "tens" digit is programmed in location 109. If activated, the siren can be silenced by entering any Arm/Disarm code.

LOCATION 110-111: PROGRAMMING FOR AUXILIARY 2

The Ranger 8900DL/DLX has the ability to report an Auxiliary 2 code and activate the pulsing buzzer each time the [4] and [6] keys are pressed simultaneously on the keypad. The desired Auxiliary 2 code is programmed in locations 110-111. If both locations are "0", the Auxiliary 2 double keypress is disabled. Location 110 contains the standard digit and location 111 contains the extended digit. When using 4+2 format, the number programmed in location 110 is sent as the second or "ones" digit. The first or "tens" digit is programmed in location 111. If activated, the keypad sounder can be silenced by entering any Arm/Disarm code.

LOCATION 112-113: PROGRAMMING FOR KEYPAD PANIC

The Ranger 8900DL/DLX has the ability to report a Keypad panic code and activate the Burg siren each time the [*] and [#] keys are pressed simultaneously on the keypad. The desired Keypad panic code is programmed in locations 112-113. If both locations are "0", the Keypad panic double keypress is disabled. Location 112 contains the standard digit and location 113 contains the extended digit. When using 4+2 format, the number programmed in location 112 is sent as the second or "ones" digit. The first or "tens" digit is programmed in location 113. If activated, the siren can be silenced by entering any Arm/Disarm code.

LOCATION 114-115: PROGRAMMING THE TAMPER FEATURE

The Ranger 8900DL/DLX has an optional tamper feature that, when enabled, will lock out the keypads for 1 minute if 30 random keypresses are made without producing a valid code. If the control is not programmed for local only, tamper will be communicated. The desired tamper code should be programmed in locations 114-115. If both locations are "0", the tamper feature will not be enabled or reported. Location 114 contains the standard digit and location 115 contains the extended digit. When using 4+2 format, the number programmed in location 114 is sent as the second or "ones" digit. The first or "tens" digit is programmed in location 115.

LOCATION 116-117: PROGRAMMING TO REPORT EEPROM CHECKSUM ERROR

The Ranger 8900DL/DLX has the ability to report a checksum error if the data in the EEPROM has changed outside of the programming mode. This report will only occur when the control is first powered or a watchdog reset has occurred.

LOCATION 118: PROGRAMMING TO REPORT CLOSINGS

The Ranger 8900DL/DLX has the ability to report a closing code each time the control is armed. The desired closing code should be programmed in location 118. If this location contains "0", closings will not be reported. When using 4+2 format the number programmed in location 118 is sent as the first or "tens" digit. The second or "ones" digit is the man number of the person that closed. When arming through a keyswitch, the man number will be 1. When using a one button "Quick Arm" code, the man number will be 1. The closing report will not be initiated until the end of the exit delay.

LOCATION 119: PROGRAMMING TO REPORT OPENINGS

The Ranger 8900DL/DLX has the ability to report an opening code each time the control is disarmed. The desired opening code should be programmed in location 119. If this location contains a "0", openings will not be reported. When using 4+2 format, the number programmed in location 119 is sent as the first or "tens" digit. The second or "ones" digit is the man number of the person that closed. When arming through a keyswitch, the man number will be 1.

LOCATION 120-121: PROGRAMMING THE COMMUNICATOR CODE FOR ZONE 1

Locations 120-121 contain the communicator code to be reported each time zone 1 creates an alarm. Location 120 contains the standard digit and location 121 contains the extended digit. When using 4+2 format, the number programmed in location 120 is sent as the second or "ones" digit. The first or "tens" digit is programmed in location 121.

LOCATION 122-123: PROGRAMMING THE COMMUNICATOR CODE FOR ZONE 2

Locations 122-123 contain the communicator code to be reported each time zone 2 creates an alarm. Location 122 contains the standard digit and location 123 contains the extended digit. When using 4+2 format, the number programmed in location 122 is sent as the second or "ones" digit. The first or "tens" digit is programmed in location 123.

LOCATION 124-125: PROGRAMMING THE COMMUNICATOR CODE FOR ZONE 3

Locations 124-125 contain the communicator code to be reported each time zone 3 creates an alarm. Location 124 contains the standard digit and location 125 contains the extended digit. When using 4+2 format, the number programmed in location 124 is sent as the second or "ones" digit. The first or "tens" digit is programmed in location 125.

LOCATION 126-127: PROGRAMMING THE COMMUNICATOR CODE FOR ZONE 4

Locations 126-127 contain the communicator code to be reported each time zone 4 creates an alarm. Location 126 contains the standard digit and location 127 contains the extended digit. When using 4+2 format, the number programmed in location 126 is sent as the second or "ones" digit. The first or "tens" digit is programmed in location 127.

LOCATION 128-129: PROGRAMMING THE COMMUNICATOR CODE FOR ZONE 5

Locations 128-129 contain the communicator code to be reported each time zone 5 creates an alarm. Location 128 contains the standard digit and location 129 contains the extended digit. When using 4+2 format, the number programmed in location 128 is sent as the second or "ones" digit. The first or "tens" digit is programmed in location 129.

LOCATION 130-131: PROGRAMMING THE COMMUNICATOR CODE FOR ZONE 6

Locations 130-131 contain the communicator code to be reported each time zone 6 creates an alarm. Location 130 contains the standard digit and location 131 contains the extended digit. When using 4+2 format, the number programmed in location 130 is sent as the second or "ones" digit. The first or "tens" digit is programmed in location 131.

LOCATION 132-133: PROGRAMMING THE COMMUNICATOR CODE FOR PANIC / HOLD-UP

Locations 132-133 contain the communicator code to be reported each time the Panic/Holdup loop creates an alarm. Location 132 contains the standard digit and location 133 contains the extended digit. When using 4+2 format, the number programmed in location 132 is sent as the second or "ones" digit. The first or "tens" digit is programmed in location 133.

LOCATION 134-135: PROGRAMMING THE COMMUNICATOR CODE FOR FIRE

Locations 134-135 contain the communicator code to be reported each time the Fire loop is shorted. Location 134 contains the standard digit and location 135 contains the extended digit. When using 4+2 format the number programmed in location 134 is sent as the second or "ones" digit. The first or "tens" digit is programmed in location 135.

LOCATION 136-137: PROGRAMMING TO REPORT AC POWER LOSS

The Ranger 8900DL/DLX has the ability to report an AC power failure code after the AC power has been off for 5 minutes. The desired AC failure code is programmed in locations 136-137. If both locations are "0", AC failure will not be reported. Location 136 contains the standard digit and location 137 contains the extended digit. When using 4+2 format, the number programmed in location 136 is sent as the second or "ones" digit. The first or "tens" digit is programmed in location 137. NOTE: THIS FEATURE MUST BE ENABLED FOR A U.L INSTALLATION.

LOCATION 138-139: PROGRAMMING TO REPORT LOW BATTERY

The Ranger 8900DL/DLX has the ability to report a low battery code when AC power has been lost and the battery has discharged to 10.3 volts. The desired low battery code is programmed in locations 138-139. If both locations are "0", low battery will not be reported. Location 138 contains the standard digit and location 139 contains the extended digit. When using 4+2 format, the number programmed in location 138 is sent as the second or "ones" digit. The first or "tens" digit is programmed in location 139.

LOCATION 140: PROGRAMMING FOR FIRE TROUBLE REPORTING

The Ranger 8900DL/DLX has the ability to report a trouble code each time the Fire loop opens. The desired trouble code is programmed in location 140. If this location contains a "0", the Fire Trouble will not be reported. When using 4+2 format the number programmed in location 140 is sent as the first or "tens" digit. The second or "ones" digit is programmed in location 134 (fire zone communicator code).

LOCATION 141: PROGRAMMING FOR ZONE BYPASS REPORTING

The Ranger 8900DL/DLX has the ability to report a by-pass on zones 1-6. The desired bypass code is programmed in location 141. If this location contains a "0", zone bypass will not be reported. When using 4+2 format the number programmed in location 141 is sent as the first or "tens" digit. The second or "ones" digit is the zone communicator code. The bypass will be reported at the end of the exit delay for non-24 hour zones. 24 hour zones will report a bypass immediately. When a bypass is removed, a restore will be reported if "Restore" is enabled in location 142.

LOCATION 142: PROGRAMMING THE COMMUNICATOR CODE FOR RESTORAL

Location 142 contains the communicator code that will be sent for restoral of a zone. If location 142 contains a "0", no restorals will be reported. If a restoral code is programmed and an extended format is selected, the restorals will be reported by zone. If a restoral code is programmed and an extended format is not selected, a restoral code will be sent when all of the previously reported conditions have restored. When using 4+2 format the number programmed in location 142 is sent as the first or "tens" digit. The second or "ones" digit will be the "ones" digit of the zone or condition that restored.

LOCATION 143: PROGRAMMING THE COMMUNICATOR CODE FOR CANCEL (EXCEPTION OPENING)

Location 143 contains the communicator code that will be sent for cancel. A cancel code will be sent if it is programmed in location 143, and an arm/disarm code is entered after a trip on zones 1 through 6 has been reported (excluding 24 hour zones). After a cancel has been reported, no loop restorals will be transmitted on non-24 hour zones. If location 143 contains a "0", cancel is disabled. When using 4+2 format the number programmed in location 143 is sent as the first or "tens" digit. The second or "ones" digit is the man number of the person that canceled. When arming through a keyswitch, the man number will be 1.

LOCATION 144: PROGRAMMING THE COMMUNICATOR TO ABORT

Location 144 is used to enable the communicator abort. A "1" in this location will cause the Ranger 8900DL/DLX to abort the report of a trip on any non-24 hour zone, if an arm/disarm code is entered prior to central station connection. If location 144 contains a "0", the Ranger 8900DL/DLX will not abort any reports.

LOCATION 145: PROGRAMMING THE SILENT PANIC/HOLD-UP

Location 145 is used to silence the audible output for a panic/hold-up alarm. Programming a "1" in location 145 will silence the audible output during a panic/hold-up alarm. If this location contains "0", the Ranger 8900DL/DLX will have an audible panic/hold-up output.

LOCATIONS 146-153: PROGRAMMING THE LOOP RESPONSE TIME

Locations 146 (zone 1) to 153 (Fire) are used to program the loop response time for each of the E.O.L. supervised zones. Programming a "1" in any of the selected zone locations will change the loop response time to 200 milliseconds. If a location contains a "0", the loop response time will be 500 milliseconds.

LOCATION 154: BURGLARY ZONE SWINGER SHUTDOWN

Location 154 is used to enable the burglary zone swinger shutdown. The number programmed in this location will determine the number of zone trips allowed before an automatic bypass of all burglary zones (1-6) which have tripped during the arming cycle. The bypassed zones will not report trips to a central station and the local siren or bell will not sound for these zones. A zone trip will not be added to the number count until after the zone has tripped more than once. If location 154 contains a "0", this feature is disabled. A zone which has been bypassed by this feature will be reported if bypass reporting is enabled in location 141. NOTE: THIS FEATURE CANNOT BE ENABLED IN A U.L. INSTALLATION.

LOCATION 155: AUTOMATIC BYPASS / INSTANT ARMING

Location 155 is used to enable automatic "Instant Arming". Programming a "1" in this location will permit the control to automatically enter the "Instant" mode and bypass interior follower zones, if a fault is not detected on an entry/exit zone during the exit delay. Programming a "3" in this location (Automatic Bypass) will permit the interior follower zones to become bypassed if a fault is not detected on an entry/exit zone, yet will not change the status of the entry/exit zone. If this location contains a "0", this feature is disabled. Pressing the [*] key when armed will cause the "Instant" light to toggle. When the "Instant" light is on, the entry/exit zone is instant; when it is off, the entry/exit is delayed. The [*] key will toggle the "Instant" mode regardless of the programming data in this location.

LOCATION 156: BUILT-IN SIREN DRIVER / 1 AMP VOLTAGE OUTPUT

The built-in siren driver has a steady sound (for Fire) and a yelp sound (for Burglary and Panic). If the built-in siren driver is NOT to be used, take the following procedure. First, remove the jumper on the PC board. Next, program a "1" in location 156. Finally, replace the jumper in the voltage position (see diagram below). Terminals 21 & 22 will now output 1 Amp at 12VDC.

LOCATION 157: L.E.D. EXTINGUISH FEATURE

Keypad LEDs (with the exception of the A.C. LED) will be extinguished after 60 seconds of keypad inactivity if a "1" is programmed in location 157. The LEDs will become illuminated immediately upon any keypress or alarm condition.

LOCATION 158: ENTERING THE NUMBER OF DIAL ATTEMPTS

Location 158 is used to enter the number of dial attempts (1 to 15 attempts) the communicator will try for each phone number before ending the notification process. If this location contains an "8", the communicator will make eight attempts to the first number and then eight attempts to the second number. NOTE:FOR U.L. INSTALLATIONS A MINIMUM OF 5 ATTEMPTS FOR ONE PHONE # OR 3 FOR 2 PHONE #'s AND A MAXIMUM OF 10 ATTEMPTS FOR 1 PHONE # AND 5 FOR 2 PHONE #'s.

LOCATION 159: POWER UP DISARMED

If a "1" is programmed in location 159, the Ranger 8900DL/DLX will power up disarmed if there is a total power shutdown and battery failure. If a "2" is programmed in location 159, it will power up armed. If it contains a "0", the Ranger 8900DL/DLX will maintain the condition at power down. A watchdog circuit reset will cause the Ranger 8900DL/DLX to reset to the selected condition.

LOCATION 160: POWER UP DELAY

If a "1" is programmed in location 160, the Ranger 8900DL/DLX will not delay 60 seconds before accepting open or short inputs from any zone. If a "0" is programmed, sensors on all zones are allowed 60 seconds to stabilize at power-up after a total power shutdown and battery failure. After 60 seconds, the Ranger 8900DL/DLX will once again accept loop opens or shorts as an alarm condition. This 60 second period will also be initiated after a watchdog circuit reset condition.

LOCATION 161: IMMEDIATE RESTORE BY ZONE

If a "1" is programmed in location 161, restoral signals will follow the restore condition and report restores immediately after the condition has unfaulted. A non-extended format will not send a message until all zones or trouble conditions have restored. If location 161 contains a "0", the restore signal or signals will be reported only after siren timeout.

LOCATION 162: NO ARMING WITH A ZONE BYPASSED

If a "1" is programmed in location 162, the Ranger 8900DL/DLX cannot be armed with any zone bypassed. If programmed with a "0", up to 5 of the 6 burglary zones can be bypassed and the Ranger 8900DL/DLX can still be armed.

LOCATION 163: PROGRAMMING THE QUICK ARM DIGIT

The Ranger 8900DL/DLX can be programmed to "Quick Arm" with one digit by programming that digit (1-9) in location 163. A "0" in this location will disable this feature. If the "Quick Arm" digit is the same as the first digit of the master code, the "Door Chime Annunciation" feature will not function.

LOCATION 164: FIRE SIREN CUTOFF INHIBIT

If a "1" is programmed in location 164, the Fire siren will sound continuously until an arm/disarm code is entered. If location 164 contains a "0", the Fire siren will shutdown at the automatic cutoff time (see location 99). Location 164 does not affect the burg siren. (Required for all UL-985 installations)

LOCATION 165: DOUBLE LINE EXTENDED ALARM REPORTING

If an extended format is selected in location 096, and a "1" is programmed in location 165, all reports will be double line extended. If location 165 contains a "0", only non-alarm reports will be extended (restore, cancel, opening, closing, bypass, and trouble). In this format, the central station will receive the report on two printed lines. The example below shows a burglary report from zone 6 of account number 999. Zone 6 was programmed to report code 3.

LINE 1:	999	3
	(ACCOUNT CODE)	(EXTENDED CODE)
LINE 2:	333	6
	(EXTENDED CODE 3 TIMES)	(ZONE CODE)

LOCATION 166: SIREN/BELL TEST FEATURE

Programming a "1" in location 166 will cause the bell or siren to come on each time the [1] and [7] keys are pressed simultaneously. The siren can be silenced with an arm/disarm code. The bell test does not cause the communicator to transmit a message.

LOCATION 167: RESETTABLE AUXILIARY POWER

Programming a "1" in location 167 will cause the Ranger 8900DL/DLX (when disarmed) to interrupt the smoke detector power each time the [#] button is pressed. If location 167 contains a "0", the smoke detector power will reset only when the [#] button is pressed and the FIRE or TROUBLE light is on.

LOCATION 168: EUROPEAN PULSE DIAL RATIO

Programming a "1" in location 168 will change the pulse dialing make/break ratio and interdigit spacing to conform to most European telecom standards.

LOCATION 169-172: PROGRAMMING THE AUXILIARY OUTPUTS

The Ranger 8900DL/DLX has 4 auxiliary outputs accessible through a pin connector on the left side of the PC board. These outputs can be activated by 16 different conditions. To utilize the outputs, program a number from "0" to "15" in locations 169 (output 1) to location 172 (output 4) according to the desired characteristics listed below. NOTE:CURRENT LIMITED TO 250 MICRO AMPS POSITIVE AND 20 mA NEGATIVE. NOTE:THESE OUTPUTS CANNOT BE USED IN A U.L.INSTALLATION.

PROGRAMMED DIGIT	ACTIVATION ON	NOTES
"0"	BURG	MOMENTARY OUTPUT
"1"	FIRE	MOMENTARY OUTPUT
"2"	PANIC	MOMENTARY OUTPUT
"3"	ARMED STATE	LATCHED OUTPUT
"4"	ARMED WITH BYPASS	LATCHED OUTPUT
"5"	AC POWER	LATCHED OUTPUT
"6"	LOW BATTERY	LATCHED OUTPUT
"7"	DURESS	MOMENTARY OUTPUT
"8"	TAMPER	LATCHED OUTPUT
"9"	TROUBLE	MOMENTARY OUTPUT
"10"	AUX2	MOMENTARY OUTPUT
"11"	ALARM MEMORY	LATCHED OUTPUT
"12"	ENTRY	LATCHED OUTPUT
"13"	EXIT	LATCHED OUTPUT
"14"	INSTANT MODE	LATCHED OUTPUT
"15"	GROUND START	MOMENTARY OUTPUT

LOCATIONS 173: INVERTING THE AUXILIARY OUTPUTS

The auxiliary outputs are normally high going low. They can be changed to low going high by programming the appropriate number in location 173. Aux output 1 has a value of "1", Aux output 2 has a value of "2", Aux output 3 has a value of "4", and Aux output 4 has a value of "8". The values for the outputs that you wish to change to low going high must be added together and the total programmed in location 173. For example, if you wish to make outputs 2 ="2" and 3 ="4" low going high, you would program a "6" (2+4=6) in location 173. NOTE:CURRENT LIMITED TO 250 MICRO AMPS POSITIVE AND 20 mA NEGATIVE.

LOCATION 174: AC POWER LOSS DELAY FEATURE

Location 174 is used to disable the 5 minute delay before reporting an AC power failure. If a "1" is programmed in location 174, AC power failures will be reported immediately. If a "0" is programmed in this location, AC power failures will not be reported until the power has been off for 5 minutes.

LOCATION 175: NUMBER OF RINGS TO ANSWER DOWNLOAD CALL

Location 175 contains the number of rings the 8900DL/DLX must detect before it will answer the download call. If a number from "1" to "15" is programmed in this location, the 8900DL/DLX will answer after THAT number of rings has been detected. If a "0" is programmed in this location, the 8900DL/DLX will not answer the download call.(SEE LOCATION 212: ANSWERING MACHINE DEFEAT)

LOCATIONS 176-177: DOWNLOADING COMPLETE COMMUNICATOR CODE

Locations 176-177 contain the communicator code that will be reported each time downloading has been completed. This report is enabled by programming a reporting code in these locations. The selected codes will be reported after a disconnect has been made from a downloading session. If these locations contain "0", the factory default setting, a report will not be initiated. Location 176 contains the standard reporting code. Location 177 contains the extended reporting code. When using 4+2 formats, the number programmed in location 176 is sent as the second or "ones" digit. The first or "tens" digit is programmed in location 177. When using an extended format, the report will be extended only if location 177 contains a number other than "0", or location 165 contains a "1".

LOCATIONS 178-179: RESERVED

LOCATIONS 180-183: PROGRAMMING THE "GO TO PROGRAM" ACCESS CODE

Locations 180-183 contain the "GO TO PROGRAM" access code. Location 180 contains the first digit of the code; location 183 contains the fourth digit of the code. THIS CODE MUST CONTAIN FOUR DIGITS AND THE FIRST DIGIT CANNOT BE THE QUICK ARM CODE! With the Ranger 8900DL/DLX disarmed, the "Go To Program" access code can be used to enter the program mode. To disable the "Go To Program" access code, program a "15" in location 180. Factory default is "Go To Program" code disabled.

LOCATIONS 184-187: DO NOT PROGRAM THESE LOCATIONS (each should be "0")

THE FOLLOWING LOCATIONS ARE ACCESSIBLE ONLY THROUGH DOWNLOADING

LOCATIONS 188-195: CONTROL PANEL ACCESS CODE

Locations 188-195 contain the eight digit access code the 8900DL/DLX must receive from the downloading software before the panel will permit downloading to occur. The factory default code is listed in the instructions provided with the CADDX download software package.

LOCATIONS 196-211: CALL BACK TELEPHONE NUMBER

The presence of a phone number in locations 196-211 will cause the control panel to dial back this number after a successful panel access code has been entered. If a telephone number is present, the control panel will hang up for approximately 36 seconds (insuring that the calling party has disconnected), then it will call back. Any zero (0) within the telephone number must be programmed as an "A". If tone dialing is desired, program an "F" in the location where tone dialing should begin. If the entire number should be tone dialing, program an "F" in location 196. Four second delays can be obtained anywhere in the sequence by programming a "D" in the appropriate delay location.

LOCATION 212: ANSWERING MACHINE DEFEAT

Location 212 contains the answering machine defeat enable. To defeat an answering machine, two telephone calls must be made to the premises. On the first call, let the phone ring the same number of times (or less) as the number programmed in this location (maximum 3). The control panel will detect these rings and start a 45 second timer. If a call comes in during that 45 second time frame, the control panel will answer on the first ring. To disable answering machine defeat, program a "0" in this location.

LOCATION 213: LOCAL PROGRAMMING LOCKOUT

Location 213 is used to disable local programming lockout. If a "5" is programmed in this location, all local programming is locked out. If an "A" is programmed in this location, all programming functions related to the digital communicator will be locked out. Any other number in location 213 will allow total local programming to take place.

LOCATION 214: CONTROL PANEL SHUTDOWN

Location 214 is used to shut down the control panel. Programming an "A" in this location will completely shutdown the control panel. The keypad will appear "dead", and the siren and communicator will not operate. **WARNING: EXTREME CARE SHOULD BE TAKEN NOT TO INADVERTENTLY PROGRAM THIS LOCATION.** NOTE: THIS FEATURE CANNOT BE ENABLED IN A U.L. INSTALLATION.

GENERAL OPERATING INSTRUCTIONS**Arming and Disarming the Ranger 8900DL/DLX**

To turn the security system on, close all protected doors and windows. The green "Ready" light will be on. Input a valid code to change the armed status. If the armed status is changed when the Fire and/or Fire Trouble LED is on, or the A.C. LED is off, the keypad sounder will start beeping to remind you to reset the Fire zone. Entering the code again will silence the keypad sounder and not change armed status (pressing the RESET [#] key will reset the FIRE LED if the short has cleared). The following conditions will prevent the armed status from changing when a code is entered:

1. The Ready light is out and the system is currently disarmed (the keypad sounder will beep 3 times if green Ready LED is not illuminated)
2. The siren is currently on for something other than a control zone (in this case silence the siren)
3. The keypad sounder is currently beeping for Fire Trouble or a Day zone (in this case silence the keypad sounder)
4. A zone is bypassed and "No Arming With Bypass" mode has been selected in the EEPROM.

Bypassing Zones

To bypass any of the zones 1-6, disarm the control and press [*], zone number(s) to bypass, and [*]. If the control is armed, it will beep 3 times after the second [*] is pressed to remind you to disarm before bypassing. If the control is in the disarmed state, the bypass condition of the zones will toggle.

Entering and Changing the Master Code (User Code #1)

When the Ranger 8900DL/DLX is first powered-up, the master code is standard default code 1-2-3-4. To change the master code from the keypad in the run (standard) mode from 1-2-3-4 to 5-6-7-8, the sequence is as follows: Press [*][1][#] which enters programming for user code #1. Now press the current master code of [1][2][3][4], followed by [*][1][#] verifying that used code #1 is being changed. Now enter the new code of [5][6][7][8], followed by [*][1][#] to exit programming. So, the entire procedure would consist of pressing 17 keys, as follows:

[*][1][#] - [1][2][3][4] - [*][1][#] - [5][6][7][8] - [*][1][#]

(NOTE: IF THE MASTER CODE IS CHANGED, ALL AUXILIARY CODES ARE INVALIDATED !)

Entering and Changing an Auxiliary Code

When the Ranger 8900DL/DLX is first powered-up the auxiliary codes are disabled. In order to program auxiliary codes you must know the master code (user code #1). Each auxiliary code has its own unique number from 2 through 15 and must be referred to by its number. The auxiliary code is programmed much like changing the master code. For example: to program auxiliary code #2 the sequence would be as follows:

[*][2][#] - [1][2][3][4] - [*][2][#] - [][][][] - [*][2][#]
(NEW CODE)

Codes 3 through 15 would be programmed by using the above sequence and replacing [2] with the appropriate number 3-15.

Removing Auxiliary Codes

To remove an auxiliary code simply program it to be the master code. For example, to remove user code #2, the sequence would be as follows:

[*][2][#] - [1][2][3][4] - [*][2][#] - [1][2][3][4] - [*][2][#]

User code #2 has now been eliminated.

Quick Arm Feature

This code is accessible only in the program mode.

Note: If an attempt is made to change any of the codes from the keypad, and a invalid master code is entered or a [*] or [#] is made part of a code, the keypad sounder will beep 3 times and the keypad will return to the normal state. If the master code is changed, all auxiliary codes will be invalidated.

Arming and Disarming With Automatic Bypass/Instant Arming

If "Automatic Bypass/Instant Arming" is enabled, there are three ways to arm the Ranger 8900DL/DLX.

1.) Input an arm/disarm code and leave the building through an entry/exit door. There will be an exit delay for leaving. When returning through an entry/exit door or delayed zone, the keypad sounder will beep continuously to remind you to disarm the system promptly.

2.) Input an arm/disarm code and stay in the building. If no entry/exit zones are tripped during the exit delay, and location 155 contains a "1", the interior follower zones will automatically bypass, the entry/exit zones will become instant, and the "Instant" LED will become illuminated. With a "3" in this location, the interior follower zones will bypass but the entry/exit zones will not change. In either case, the interior delay zones will be unaffected.

3.) Bypass all the interior zones, arm the system and stay in or leave the building. In either case, the entry/exit zones will not become instant if all the interior zones were bypassed prior to arming.

Door Chime Annunciation

This feature is used as an annunciator feature when the Ranger 8900DL/DLX is disarmed. When Door Chime Annunciation is activated, a fault on a delayed, instant, or entry/exit zone will produce a one second beep. Interior follower zones or bypassed zones will not be annunciated. To activate Door Chime Annunciation, enter the first digit of the master code and wait 5 seconds. The keypad will produce a one second sound (beep) to notify you of the activation of this feature. Follow the same procedure to deactivate the Door Chime Annunciation feature. This feature cannot be activated when the system is armed.

Smoke-Detector Reset

Pressing the RESET [#] key when the Fire LED is on will produce a 10 second interruption of the smoke detector power output. When power is restored to the loop, the Fire LED and/or Fire Trouble LED will extinguish if the Fire loop has returned to a normal state. The condition of the Fire loop is ignored during reset. The Ranger 8900DL/DLX can also be programmed to produce a 10 second interruption of the smoke detector power output without regard for the condition of the fire loop (only when the system is disarmed). This feature can be used with other sensors when memory LEDs are reset by removal of power. If the fire loop has not reset, the keypad sounder will begin to beep at the end of the 10 second reset period.

Alarm History

Five seconds after pressing the zero [0] key, the keypad will annunciate "Freeze Frame" alarm history. The zone LEDs will indicate which zone(s) caused the last alarm, regardless of the number of times the Ranger 8900DL/DLX has been armed or disarmed since that alarm. It annunciates by flashing the zone LED(s) that caused the alarm and lighting steady those that were bypassed when the alarm occurred. The annunciation will continue for 5 seconds. Alarm History is erased when the Ranger 8900DL/DLX is placed into the program mode.

Siren/Bell Test Feature

This feature is enabled by programming a "1" in location 166. When enabled, pressing the [1] and [7] keys simultaneously on the keypad will sound the siren/bell without making a communication. Entering an arm/disarm code will silence the siren/bell.

Zone Recycling

All zones on the Ranger 8900DL/DLX will reset independent of each other. When a zone has reset, it is then able to create another audible alarm. If the siren/bell has not recycled, a trip or a re-trip will extend the time for another recycle period.

Manual Telephone Answering

The 8900DL/DLX can answer the telephone in the run mode by entering [*]-[9]-[9]-[#] at the keypad when the phone is ringing. The telephone line will be seized and the control will request an access code. This function can be used to save time when a long number of rings is programmed and someone is on the premises.

KEYPAD OPERATION

The Ranger 8900DL/DLX will accept up to four Control Keypads. The keypad is a four wire keypad that has a 12 key telephone type keypad, a sounder, and 12 LEDs.

The LEDs are used to indicate the following:

ARMED - (red) On when system is armed; off otherwise. Blinks on non-24 hour zones as alarm memory until a valid code is entered.

READY - (green) On when zones 1 through 6 are good; off otherwise.

INSTANT - (red) On when the entry/exit zones are instant; off otherwise.

AC ON - (red) On when AC power is on; off otherwise. This light will not go out in the LED extinguish mode unless A.C. power is lost.

FIRE - (red) Latches on when fire loop shorts. Reset by pressing the RESET [#] key; off otherwise.

TROUBLE - (red) Latches on when fire loop opens. Reset by pressing the RESET [#] key; off otherwise. Flashes on system error.

ZONES 1-6 - (yellow) On when bypassed; blinking when faulted; off otherwise. Blinks when "Freeze Frame" alarm history is being shown, if faulted during the last alarm. On steady for zone(s) bypassed during last alarm.

Keypad Sounder - The keypad sounder is built into the keypad and will sound for the following reasons:

- Beeps for all key presses.
- Sounds continuously during entry delay.
- Pulses when a Day zone trips, when fire trouble occurs, or when the armed status changes and the Fire or Trouble LED is on, or if the A.C. LED is off. When pulsing, it can be silenced by entering an arm/disarm code. (armed status will not change)
- 3 Beeps for trying to arm when a faulted zone is not bypassed.
- Beeps 1 second for Door Chime Annunciation and activation of Door Chime Annunciation.
- 3 Beeps when errors are made reprogramming codes.
- Beeps 1 second at the end of the exit delay.
- Beeps 3 times when all zones are bypassed or any zone is bypassed and the "No Arming With Bypass" mode has been selected in the EEPROM.
- Beeps 3 times when a error is made when bypassing a zone.
- Beeps 3 times to let the user know if the armed status did not change.
- Pulses continuously after smoke detector reset when loop has not re-stored.

INSTRUCTIONS FOR UNDERWRITERS LABORATORIES 985 AND 1023 INSTALLATIONS

When installing a Ranger 8900DL/DLX in compliance with UL-985 (Residential Fire) and UL-1023 (Residential Burglary) the following instructions must be followed.

- The Ranger 8900DL/DLX Control Panel and keypad must be mounted indoors and within the protected area.
- The rechargeable system battery should be replaced at no more than four year intervals. The Ranger 8900DL/DLX should be tested annually with and without A.C. power. This will insure that the battery is connected and adequately charged at the time of the test.
- All electrical wiring connected to the Ranger 8900DL/DLX must be installed in accordance with the National Electrical Code, ANSI and NFPA standards.
- When the built-in digital communicator is utilized in conjunction with a U.L. installation it must report at a minimum a burglary zone, a fire zone, and A.C. power failure. The minimum number of dialing attempts programmed must be 5 if one phone number is used and 3 if two phone numbers are used. The maximum number of dialing attempts programmed must be 10 if one phone number is used and 5 if two phone numbers are used.
- Swinger shutdown feature must not be enabled.
- Control panel shutdown must not be enabled.
- U.L. has tested the Ranger 8900DL/DLX to be compatible with the Silent Knight No. 9000 receiver.
- All interconnections to the Ranger 8900DL/DLX must be made using U.L. labeled limited energy cable.
- Use Caddx Part #EOL-34UL for all U.L.985 installations.

TYPICAL FIRE INSTALLATION LAYOUT

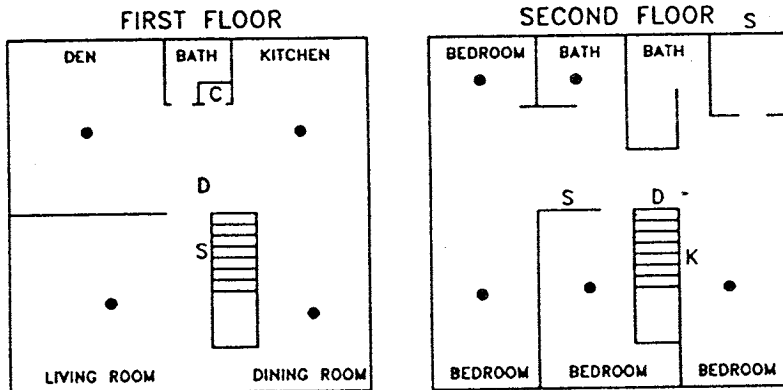

LEGEND:
 C - Control ● - Thermostats
 S - Siren (Steady Output) K - Keypad
 D - Smoke Detector

NOTE: Alternate locations may be required for the devices indicated

NOTE: Installation of fire detection equipment in all rooms and areas of the household is suggested for early warning fire detection. A smoke detector should be installed on each level and in each separate sleeping area (the vicinity of, but outside of the bedroom), with heat or smoke detectors in living rooms, dining rooms, bedrooms, kitchens, hallways, attics, furnace rooms, closets, utility and storage rooms, basements, and attached garages.

LOCAL TELEPHONE COMPANY INTERFACE INFORMATION

TELEPHONE CONNECTION REQUIREMENTS

Except for telephone company provided ringers, all connections to the telephone network shall be made through standard plugs and standard telephone company provided jacks or equivalent in such a manner as to allow for immediate disconnection of the terminal equipment. Standard jacks shall be so arranged that if the plug connected thereto is withdrawn, no interference to the operation of the equipment at the customers premises which remains connected to the telephone network, shall occur by reason of such withdrawal.

INCIDENCE OF HARM

Should terminal equipment or protective circuitry cause harm to the telephone network, the telephone company shall, where practical, notify the customer that temporary discontinuance of service may be required; however, where prior notice is not practical, the telephone company may temporarily discontinue service if such action is deemed reasonable in the circumstances. In the case of such temporary discontinuance, the telephone company shall promptly notify the customer who will be given the opportunity to correct the situation. The customer also has the right to bring a complaint to the FCC if he feels the disconnection is not warranted.

CHANGES IN TELEPHONE COMPANY EQUIPMENT OR FACILITIES

The telephone company may make changes in its communications facilities, equipment, operations, or procedures where such action is reasonably required and proper in its business. Should any such change render the customers terminal equipment incompatible with the telephone company facilities, the customer shall be given adequate notice to make modifications to maintain uninterrupted service.

GENERAL

The FCC prohibits customer provided terminal equipment be connected to party lines.

IMPORTANCE OF THE RINGER EQUIVALENCE NUMBER

The Ringer Equivalence Number of this device is 0.2 B. This number is a representation of the electrical load that it applies to your telephone line.

MALFUNCTION OF THE EQUIPMENT

In the event that the device should fail to operate properly, the customer shall disconnect the equipment from the telephone line to determine if it is the customers equipment that is not functioning properly. If the problem is with the device the customer shall discontinue use until it is repaired.

EQUIPMENT INFORMATION

MANUFACTURER OF CONNECTING EQUIPMENT: CADDX-CADDI CONTROLS INC., FCC REGISTRATION NUMBER: GCQ4DC-17266-AL-E, RINGER EQUIVALENCE: 0.2 B

Description of Major Features

- Up to 15 user codes including an optional "Duress" code
- Single digit "Quick Arm" code feature
- Microprocessor Watchdog circuit with dead battery microprocessor shutdown
- An advanced "Freeze Frame" alarm history allows you to see the exact condition of the control zones during the last alarm
- Each zone is E.O.L. supervised for maximum protection and flexibility
- Fully supervised Fire loop
- Four wire keypad
- A unique keypad "LED Extinguish" feature saves current on standby battery and allows the keypad to be used in sleeping areas without disturbing the occupants
- Built-in two channel siren driver or optional 1 Amp DC voltage output
- 500 mA of auxiliary power
- 100 mA, keypad resettable, smoke detector power
- Separate fuse for auxiliary power makes the keypad tamper resistant
- Low battery and A.C. Failure detection with report options
- Advanced transient protection featuring state of the art Transorb technology
- Optional Manual Panic and Auxiliary 1, Auxiliary 2, activation from the keypad
- EEPROM memory holds all programming features even after total power failure

The communicator has all the power necessary for the most demanding applications. Yet it remains easy to program. Standard communicator features include:

- Choose from a list of 15 standard formats including Radionics high speed with parity, double line parity, and true 4-2
- Each zone code is programmable
- Opening and closing reports by user
- Two 16 digit or one 31 digit phone number allows you to switch back and forth between tone and pulse dialing
- Extended reporting formats available
- Programmable number of communication attempts
- Line seizure
- DTMF (tone) and pulse dialing

SYSTEM NOTES

SPECIFICATIONS

OPERATING POWER	16.5 VAC 25 VA Transformer
AUXILIARY POWER	12 VDC 500 mA (400 mA for U.L.)
LOOP RESISTANCE	300 Ohms Maximum
BUILT-IN SIREN DRIVER	2-tone (Steady and Yelp)
ALARM CURRENT AVAILABLE (IF ABOVE DRIVER IS NOT USED)	1 Amp
LOOP RESPONSE	Selectable @ 200ms or 500ms
OPERATING TEMPERATURE	32° to 120° F
KEYPAD DIMENSION	4.90" Wide 4.40" High 1.25" Deep
METAL ENCLOSURE DIMENSION	11.25" Wide 11.25" High 3.50" Deep
SHIPPING WEIGHT	9 lbs.

WARRANTY STATEMENT

CADDX-CADDI CONTROLS, INC. GUARANTEES THIS PRODUCT TO THE ORIGINAL PURCHASER AGAINST DEFECTIVE PARTS AND WORKMANSHIP FOR TWENTY-FOUR (24) MONTHS FROM DATE OF MANUFACTURE.

IF ANY DEFECT APPEARS DURING THE WARRANTY PERIOD RETURN IT TO CADDX, POSTAGE PREPAID. THE UNIT WILL BE REPAIRED AND RETURNED.

CADDX ASSUMES NO LIABILITY FOR CONSEQUENTIAL OR INDIRECT DAMAGE AND ACCEPTS NO RESPONSIBILITY FOR REPAIRING DAMAGE TO THE PRODUCT CAUSED BY MISUSE, CARELESS HANDLING, OR WHERE REPAIRS HAVE BEEN MADE BY OTHERS.

NO OTHER GUARANTEE, WRITTEN OR VERBAL, IS AUTHORIZED BY OR ON BEHALF OF CADDX-CADDI CONTROLS, INC., GLADEWATER, TEXAS.

CADDX-CADDI CONTROLS, INC
1420 NORTH MAIN STREET
GLADEWATER, TEXAS 75647
IN TEXAS 800-727-2339
TOLL FREE 800-652-2339
FAX 903-845-6811