



MOOSE Z900

Security System Control

Specifications, Installation
and Programming Guide

Introduction

The Z900 Security Control incorporates today's most desired operational features including upload/download, dual reporting, EEPROM memory, advanced lightning/transient protection and ease of user operation, all in an attractively priced package, complete with control station. The control is pre-programmed with two delay zones, one instant interior zone, and three instant perimeter zones. In addition, three emergency zones are accessible through Z900R control stations. The control may also utilize Z700R control stations in installations which require only a single emergency zone. One high current output is assignable to provide +12VDC upon any or all Burglar, Auxiliary, or Emergency alarms, or it may be assigned to one selectable non-alarm condition. In addition, an optional Z729 Siren Driver/Output Expander may be added to provide a built-in two channel, high powered siren driver and 10 assignable low current outputs which may be used to trigger other devices.

Non-volatile EEPROM (electrically erasable programmable read only memory), allows the control to be easily programmed from the Z900R control station. The EEPROM maintains its data even with power disconnected. A "Watchdog" circuit monitors the microprocessor and assures the operational integrity of the system. An optional MPI230 hand held Chip Duplicator allows the entire memory contents to be copied from one control to another, reducing installation time. The control may also be programmed remotely with the aid of a personal computer and a phone modem using the manufacturer's TRANSPORT-PC ® software package.

The Z900R control station features separate status indicators for each of the six hardwire zones, "Ready" and "Armed" LEDs, an "Alarm" LED which illuminates simultaneously with the alarmed hardwire zone for easy identification, and a "Trouble" LED which lights when installer attention is required. The control may also be armed/disarmed with a momentary or shunt type key switch.

This product has been carefully inspected to comply with rigid quality control standards before shipment to you. You'll find that with reasonable care it will provide years of reliable performance. Proper installation and regular maintenance by the installing company and frequent testing by the user are essential to assure continuous satisfactory operation of any alarm system. It is recommended that the installing company offer a maintenance program and instruct the user with the correct procedure for proper use and testing of the system.

LIMITATIONS

The Z900 is designed as part of a system designated to warn against unauthorized entry or of other emergency situations. However, it is not a guarantee of protection against the occurrence of those events. Any alarm system is subject to compromise or failure to warn for various reasons: Unauthorized access can be gained through unprotected points or by disarming or bypassing protected points. Sensing devices are power driven and will not operate without power. Telephone lines over which alarm signals are transmitted may be out of service or rendered inoperable by an intruder. Smoke detectors have limitations and cannot detect all types of fires, nor will they sense smoke or fire which is out of the effective range of the detector.

ALL RIGHTS RESERVED

No part of this publication may be reproduced, stored in a retrieval system, or transmitted in any form, or by any means - electronic, mechanical, photocopying, recording, or otherwise without the prior written permission of the manufacturer. The material in this publication is for information purposes and subject to change without notice. The manufacturer assumes no responsibility for any errors which may appear in this publication. Printed in U.S.A.

ff SPECIAL NOTE referencing use of the word "Fire" in this manual.

Use of this control for fire detection and/or annunciation may not be permitted by certain states, counties, municipalities, or local jurisdiction. It is the responsibility of the installing alarm company to check with their local A.H.J. (Authority Having Jurisdiction) or State Fire Marshal's office prior to using this control for fire.

Table Of Contents

Installation and Wiring 1

PLANNING THE INSTALLATION	1
PARTS DIAGRAM & DESCRIPTIONS	2
MOUNTING AND WIRING PREPARATION	3
WIRING	3
EARTH GROUND	3
STANDBY BATTERY and TRANSFORMER	6
HARDWIRE ZONE INPUTS (TERMINALS 10-18)	6
Class "B" End-of-Line Resistor Supervised Zones	6
Non-Supervised Closed Circuit Loop	7
Hardwire Zone Wiring Procedure	7
24 Hour Auxiliary Zones	8
24 Hour Communicator Report Zones	8
Keyswitch Zone	8
CONTROL STATION WIRING (TERMINALS 6, 7, 8, 9)	8
CONTROL STATION MOUNTING	9
Troubleshooting	9
CONTROL BOARD FUSES	9
Fuse F1	9
Fuse F2	9
Battery Lead Fuse	9
12 VDC OUTPUTS	10
Switched Power (Terminal 4)	10
Auxiliary 2 (Terminal 5)	10
Keypad Power/Auxiliary 1 (Terminal 7)	10
Assignable Output (Terminal 3)	11
Additional Outputs	11
Control Station Activated Panic Zones	11
TELEPHONE LINE CONNECTION (TERMINALS 19-22)	12

Operating the System 2

POWERING UP THE CONTROL	13
PROCEDURE	13
Watchdog Monitor	13
Automatic System Diagnostics Upon Power-Up	13
PROCESSING OF ALARMS FOLLOWING TOTAL POWER LOSS	13
THE Z900R CONTROL STATION	14
CONTROL STATION POWER-UP AND SUPERVISION	14
USER OPERATION	14
Arming/Disarming	14
Alarm Status	14
Manually Resetting Alarms	14
Control Station Activated Panic Zone Operation	15
Zone Shunting (Bypassing)	15
INSTALLER DIAGNOSTIC FEATURES	16
Identifying "Trouble" Conditions (Key 2)	16
Alarm Memory Retrieval (Key 3)	18

Programming the Control.....

3

INSTALLER LEVEL PROGRAMMING	19
INSTALLER PROGRAM AUTHORIZATION CODE	19
ENTERING INSTALLER LEVEL PROGRAMMING UPON POWER-UP	19
THREE MINUTE PROGRAMMING TIMER	19
PROGRAM FUNCTIONS	19
THE “#” (FIND) AND “*” (STORE) KEYS	20
READING THE VALUE OF A FUNCTION	20
ZONE PLANNING GUIDE	20
PROGRAM FUNCTION MAP	21
EXITING THE PROGRAMMING MODE	21
INSTALLER LEVEL PROGRAMMING EXAMPLE	21
RESTORING THE FACTORY DEFAULT PROGRAM	21
USER LEVEL PROGRAMMING	22
MASTER USER AUTHORIZATION CODE	22
USER LEVEL PROGRAMMING FORMAT	22
USER LEVEL PROGRAMMING EXAMPLE	22
SPECIAL PROGRAMMABLE FEATURES	23
REMOTE PROGRAMMING (UPLOAD/DOWNLOAD)	23
On-Site “Manually” Assisted Method	23
Auto Answer and Callback Method	23
Answering Machines	23
SILENCE EXIT DELAY BEEP	23
FORCE ARMING	23
Z729 SIREN DRIVER/OUTPUT EXPANDER	23
SUPERVISORY/TROUBLE ZONE SUB-OPTION	24
SHUNTABLE 24 HOUR AUXILIARY “A”, “B”, “C”, AND KEYSWITCH ZONES	24
PRIORITY (NON-SHUNTABLE) BURGLAR ZONES	24
HIGH SECURITY ARM/DISARM CODE	24
GROUP SHUNTING	24
DIGITAL COMMUNICATOR	24
Telephone Line Seizure	24
PROGRAM FUNCTION DESCRIPTIONS	25 through 38

Specifications

4

TECHNICAL SPECIFICATIONS	39
Z900 FEATURES	40
OPTIONAL ACCESSORIES	40
CONTROL BOARD COMPONENT LAYOUT (FIGURE 17)	41
CONFIGURATIONS AND CURRENT DRAIN PROVISIONS (TABLE 10)	42

N.F.P.A. Requirements

5

..... 43 through 44

INDEX

6

Installation and Wiring

PLANNING THE INSTALLATION

The first step in any multi-zone security system installation is planning the job.

1. Read through this entire manual to familiarize yourself with all system features and procedures before actually beginning the installation. Section 5 contains information regarding N.F.P.A. requirements.
2. Perform a physical survey of the installation site.
3. Discuss the installation requirements and applications with the customer.
4. Compare the installation requirements and applications with the factory default settings (see Function Map, pages A-C) to determine what, if any, customized programming will be needed to meet the specific installation requirements.
5. We recommend that the system be bench tested prior to installation.

**Figure 1 details a typical burglar installation layout.
This may be used as a guide in planning the specific installation**

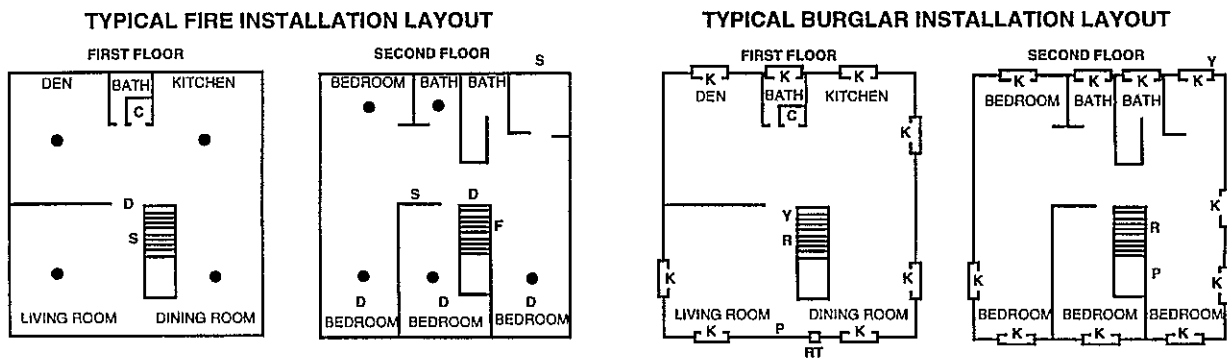

Note: Alternate locations may be required for the devices indicated.

Note: All perimeter openings below 18' should be provided with protection.

LEGEND:

- | | | |
|---------------------------|-------------------------|--------------------------------|
| C - Control | ● - Thermostat | P - Panic Button |
| S - Siren (Steady Output) | F - Fire Trouble Remote | RT - Remote On/Off with Tamper |
| Y - Siren (Yelp Output) | K - Contact | |
| D - Smoke Detector | R - Remote On/Off | |

FIGURE 1 TYPICAL INSTALLATION LAYOUT

PARTS DIAGRAM & DESCRIPTIONS

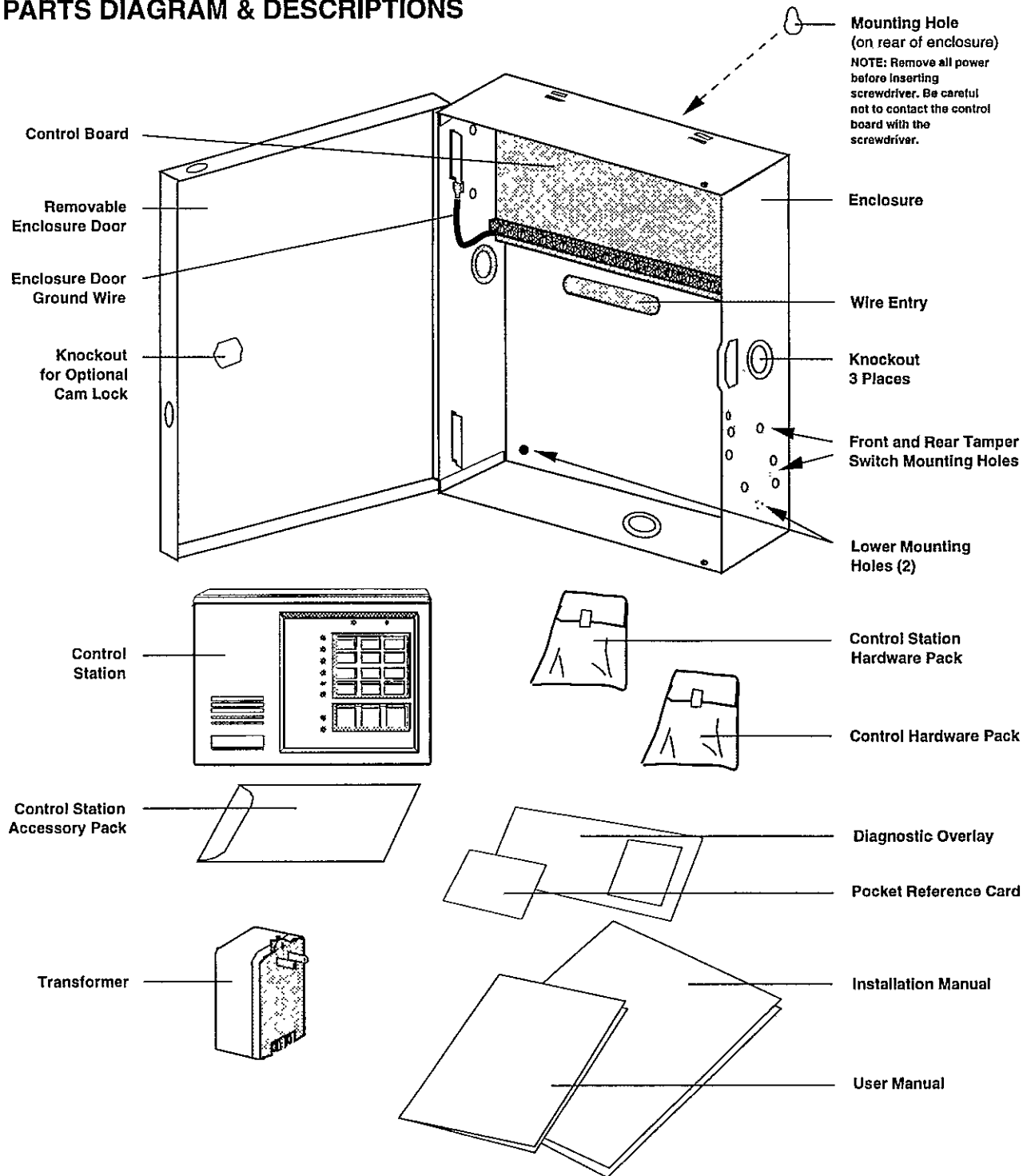

FIGURE 2 Z900 PARTS LIST

MOUNTING AND WIRING PREPARATION

1. Remove all packing material and compare the system components with those in Figure 2, page 2 to familiarize yourself with the part names as this manual will refer to them periodically.
2. Select a proper mounting location. The control must be mounted in a secure, dry location capable of maintaining an ambient temperature inside the control box of 32 to 122 degrees Fahrenheit (0 to +50 degrees Celsius).
3. Remove package components from the enclosure and set aside until pre-wiring is completed.
4. Remove control box knockouts that best suit your wiring needs. Note that each knockout is a "dual" size. The "inside" knockout is for 1/2" conduit and the "outside" is for 3/4" conduit.
5. Mount the control using the upper center slotted hole and two lower mounting holes.
6. Proceed to pull all necessary wiring for the power transformer, detection loops, control stations, siren outputs, etc.
7. Once all field wiring has been brought into the enclosure, it should be terminated as per the instructions on the following pages.

WIRING

EARTH GROUND

In order for the control's lightning and transient protection to be effective, the control must be connected to an earth ground. Finding a proper ground path may effect selection of the control mounting location as it is important to run the ground wire as short as possible.

An ideal ground for a security system is a "UNIFIED EARTH GROUND", whereby the power line, telephone, and security system ground rods are bonded together. This type of ground eliminates a common problem during lightning strikes known as "STEP VOLTAGE BLOWOUT". Step voltage is a measurable voltage potential between different earth ground stakes during a lightning strike, which results in a destructive current flow path through the security equipment.

Ground wires should be run the shortest and straightest path between the equipment and the ground rod. Avoid sharp 90 degree turns as they can cause undesired inductance in the earth ground path. This inductance blocks the lightning path to earth ground causing the lightning current to run through the security equipment. Follow the steps below to earth ground the control:

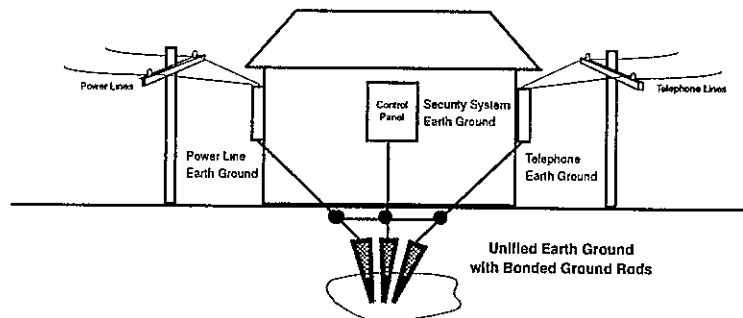

FIGURE 3 UNIFIED EARTH GROUND

1. Connect the Ground Wire to the control with a minimum 14 gauge solid ground wire.
2. Remove the lower left control board mounting screw, insert it through the Ground Wire Lug, and replace the screw, securing the ground wire.
3. Run the earth ground wire and attach to a bonded earth ground following these guidelines:
 - A. Keep wire runs short. No 90 degree or sharp turns.
 - B. Use a minimum radius of 8 inches for bends.
 - C. Run ground wires separate from other wires.
 - D. Use 8 foot copper clad ground rods.
 - E. Route toward earth and never away.
 - F. Never run parallel to metal without properly bonding to the metal.
4. The enclosure door must be mutually grounded. Connect the female plug on the end of the green ground jumper wire (which is attached to the lower left control board mounting screw) to the bottom of the upper enclosure door hinge (see Figure 2, page 2).

TERM.	FUNCTION	DESCRIPTION
1	AC INPUT	Connect 16.5 VAC 35 VA U.L. Class II transformer (Part #T-1635) using 18 gauge minimum, 2 conductor wire. Do not exceed 50 feet. Do not plug in until all wiring is complete.
2	AC INPUT	
3	ASSIGNABLE OUTPUT (+)	(+)12VDC for powering devices upon alarm or other conditions as defined by Functions 256-260. See page 11. †
4	SWITCHED POWER (+)	(+)12VDC for powering smoke detectors. Control station key #7 temporarily interrupts this output to reset detectors. †
5	AUXILIARY POWER 2 (+)	(+)12VDC for powering motion detectors and other accessories. This output is fused commonly with Assignable Output (terminal 3) at 2.5 Amps (F1) and must be considered when calculating total current drain. †
6	COMMON NEGATIVE	Negative termination for devices powered by terminals 3, 4, 5, and 7. (Same as terminals 11, 14, and 17).
7	KEYPAD/AUXILIARY POWER 1 (+)	(+)12VDC for powering control stations, motion detectors, and other accessories. This output is fused commonly with Switched Power at 2.5 Amps (F2) and must be considered when calculating total current drain. †
8	CONTROL STATION DATA IN	Connect control station green leads to this terminal. Connect control station white leads to this terminal. (Use Z700 and/or Z900 control stations)
9	CONTROL STATION DATA OUT	
10	ZONE 1 LOOP (+)	Each loop requires a 2,200 Ω end-of-line resistor. Closed or open circuit contacts may be connected to each loop. A common negative is shared between each group of two (2) zones. The need for end-of-line resistors may be eliminated on all Burglar defined zones through programming (Function 248) if desired.
11	ZONE 1 AND 2 COMMON (-)	
12	ZONE 2 LOOP (+)	
13	ZONE 3 LOOP (+)	
14	ZONE 3 AND 4 COMMON (-)	
15	ZONE 4 LOOP (+)	
16	ZONE 5 LOOP (+)	
17	ZONE 5 AND 6 COMMON (-)	
18	ZONE 6 LOOP (+)	
19	INCOMING TELEPHONE LINE (T) "TIP"	Green wire from RJ-31X direct connect telephone cord. Red wire from RJ-31X direct connect telephone cord.
20	INCOMING TELEPHONE LINE (R) "RING"	
21	HOUSE PHONE CONNECTION (T1)	Brown wire from RJ-31X direct connect telephone cord. Gray wire from RJ-31X direct connect telephone cord.
22	HOUSE PHONE CONNECTION (R1)	

† Terminals 3 and 5 are fused at 2.5 Amps (fuse F1). Terminals 4 and 7 are fused at 2.5 Amps (fuse F2). Combined alarm condition current should not exceed 1.5 Amps. Maximum combined continuous current drain should not exceed the limits as indicated in Table 10, page 42.

TABLE 1 CONTROL BOARD TERMINAL DESCRIPTIONS

Z900 Specifications and Instructions

STANDBY BATTERY and TRANSFORMER

The control is powered by a 16.5 volt 35VA U.L. listed Class II plug-in transformer (part # T1635/supplied). Follow the wiring instructions as indicated in Table 1 and Figure 4 and 5.

A 12 Volt, 4 Amp hour minimum sealed lead acid rechargeable battery (part #B1240/not supplied) must be installed to provide primary power back up. The float charge voltage for the battery is set for 13.8 Volts at 400 milliamps (mA) maximum, while the system is delivering its rated continuous output current. Current in excess of 400 mA can be delivered to the battery if the system is delivering less than the rated power. The battery charging current is limited through a 5 Ohm resistor.

The battery automatically takes over and provides power in the event of an AC power outage. If the AC fails for an extended period and the battery voltage drops below 11.2 volts, the low battery detector will activate and cause the control station prealarm to beep, the "Trouble" LED to light and the digital communicator to report to the central station (if so programmed). The beep can be silenced by pressing the " * " key.

If, during a loss of AC power, the battery voltage should drop below 7.5 Volts, the microprocessor will shut down, but there will still be auxiliary equipment current drain on the battery. An MPI -267 Power Disconnect may be added to disconnect the battery and protect it against deep discharge.

- Place the battery in the enclosure. Make sure that the AC transformer is disconnected.
- Connect the black battery wire to the black battery terminal marked " - ".
- Connect the red battery lead to the red battery terminal marked " + " after wiring of the control is complete.

NOTE: A reverse current diode provides some protection to the electronics if the power leads are accidentally reversed.

DO NOT LEAVE THE LEADS REVERSED. OVERHEATING OF RESISTOR R85 WILL RESULT.

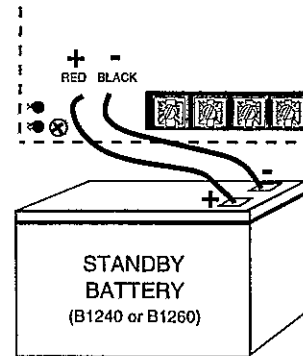

FIGURE 5

HARDWIRE ZONE INPUTS (TERMINALS 10 - 18)

The system provides six(6) individually programmable class "B" end-of-line resistor supervised detection zones. If desired, the Burglar zones may be converted from class "B" E.O.L. resistor supervised to non-supervised closed circuit only. Each hardwired zone may be configured as a Burglar, 24 hr. Auxiliary "A" (Fire *ff*), 24 hr. Auxiliary "B" (Police), 24 hr. Auxiliary "C" (Emergency), or communicator report only zone. In addition, a single zone may be programmed to allow system key switch operation. Each of the six zones may be further defined with various options and sub-options. The Zone Planning Guide on page D assists in planning each zone.

CLASS "B" END-OF-LINE RESISTOR SUPERVISED ZONES

In order to function properly as a class "B" supervised circuit, a zone must have a 2,200 Ohm 1/4 watt resistor installed in series at its furthest most remote end from the control. This configuration allows both open and closed circuit contacts to be used on the same loop and provides a high degree of protection against compromise or tampering (see Figure 6). The control constantly measures the resistance on a class "B" zone and is able to determine by a proper reading of approximately 2,200 Ohms, that a zone is secure and intact. It can respond differently to a high resistance (loop open) versus a low resistance (loop short). For example, a class "B" Fire (*ff*) zone reacts with a supervisory/trouble condition when opened and an alarm when shorted. Supervisory/trouble is a programmable sub-option for each of the other five zone types. There is even a choice of whether a trouble condition should occur upon an open or short (non-Fire zones only). For more information see "Supervisory/Trouble Sub-Option", page 24. The system comes equipped with six 2,200 ohm 1/4 watt resistors, one for each zone. The resistors are color coded red • red • red and either a gold or silver fourth band.

NON-SUPERVISED CLOSED CIRCUIT LOOP (NO E.O.L. RESISTOR SUPERVISION)

If end-of-line resistor supervision of all burglar loops is not desired, conventional closed circuit loops may be connected directly to all Burglar zone input terminals by first programming Function 248 with a value of 1.

HARDWARE ZONE WIRING PROCEDURE

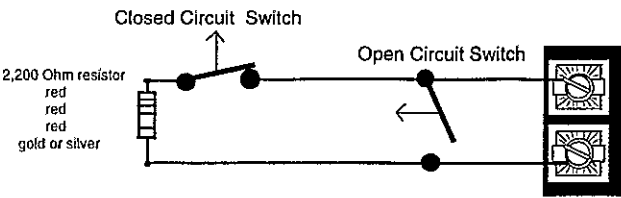

Any loop short or open will greatly change circuit resistance and violate the zone. The resistor must be placed at the end of the loop.

FIGURE 6
E.O.L. RESISTOR SUPERVISED LOOP

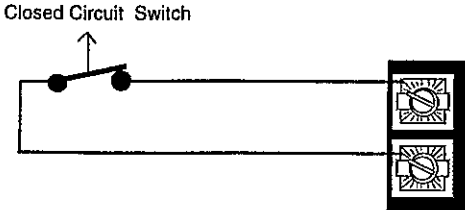

Only Burglar defined zones may be wired non-supervised and Function 248 must be programmed with a value of "1". All Burglar defined zones will then become non-supervised loops.

FIGURE 7
NON-SUPERVISED CLOSED CIRCUIT LOOP

Figure 8 is an example of how each of the detection zones might be configured in a typical installation. For ease of explanation, zones 1-6 are shown in their factory default programming configuration. They may of course be re-programmed to suit the specific needs of each installation. At this point it is only necessary to decide what each zone will be used for and make the necessary connections. Programming the actual zone definitions and responses will be explained in Section 3.

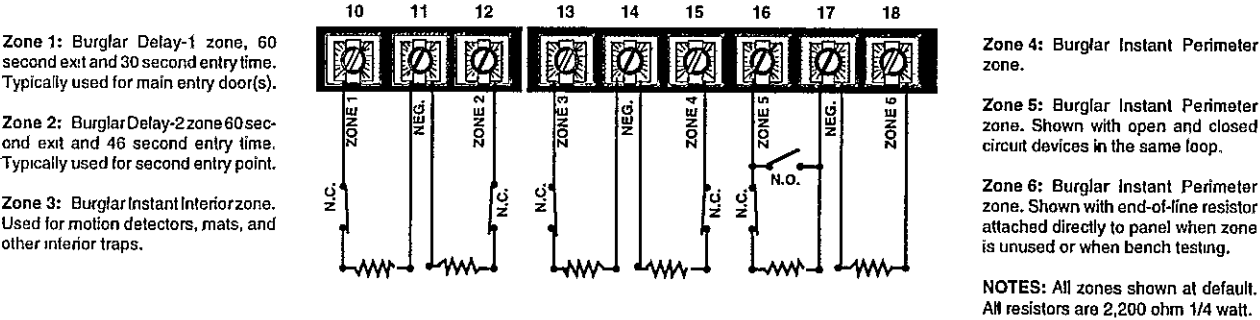

FIGURE 8
TYPICAL ZONE WIRING EXAMPLE

1. Decide whether Burglar defined zones are to be wired as an end-of-line resistor supervised circuit or a non-supervised closed circuit only.
2. Connect all alarm sensors to the zone wiring as per the instructions provided by the individual sensor manufacturer and Figures 4, 6 and 7.
3. Connect each zone wire to the appropriately labeled terminals as per Figure 8. Each zone has an input terminal and a common (negative) return. Please note that a negative terminal is shared by two zones and that all negatives are common to each other.
4. If end-of-line resistor supervision is not required on Burglar defined zones, Program Function 248 with a value of "1".
5. If 12 volt DC powered detection devices such as motion sensors are being installed, refer to section "12VDC Outputs".
6. Define each zone utilizing the "Zone Planning Guide" and program the zone definition value into the corresponding Function (see Section 3).

Z900 Specifications and Instructions

□ 24 HOUR AUXILIARY ZONES

Zones defined as 24 hour Auxiliary "A", Auxiliary "B" or Auxiliary "C" zones MUST be wired as E.O.L. resistor supervised loops. These loops are commonly used for Fire (ff), Police or Emergency inputs, however, they may also be used for other devices requiring 24 hr. supervision. A 24 hour Auxiliary "A" defined zone provides an alarm upon a loop short utilizing open circuit sensors and provides a supervisory/trouble upon an open or break in the loop. Auxiliary "B" and Auxiliary "C" defined zones can also be programmed with the supervisory/trouble sub-option.

□ 24 hr. COMMUNICATOR REPORT ZONES

Communicator report only zones MUST be wired as E.O.L. resistor supervised loops. When activated they provide no keypad indication or panel outputs and are therefore intended for simply reporting conditions from temperature sensors, water sensors, etc.

□ KEY SWITCH ZONE

A single zone may be programmed to allow the system to be armed/disarmed with one or more momentary or maintained (shunt) contact key switch(s).

When the momentary key switch is held closed for one second, the pre-alarm will beep to indicate that the key change was acknowledged. When the key switch closure is released, the control will arm/disarm. If program Function 185 is enabled, holding the key switch closed will change the interior on/off mode once each second, then after the interior status is displayed, release the key switch to arm the system. A key switch defined zone MUST be wired as an E.O.L. resistor supervised loop. If programmed with the supervisory/trouble definition, a tamper switch may be wired to disable the key switch arm/disarm capability if the zone is violated.

If a zone is programmed for maintained key switch usage, the control stations will be disabled from either arming or disarming the control. Only that key switch defined zone may be used to arm or disarm.

NOTE: Do not define a maintained key switch zone for supervisory/trouble conditioning.

CONTROL STATION WIRING (TERMINALS 6, 7, 8, 9)

The control stations connect to the control terminals using only a four conductor cable. Four conductor, 22 gauge solid (or larger) jacketed cable is satisfactory for this hook-up, however, stranded wire provides additional resistance to bending and breakage. A shielded cable with the control end connected to earth ground provides additional protection from lightning. Connect the four control station wires as indicated in Table 2 below.

The total number of control stations that may be used per system varies, depending upon the total current drain from terminal 4 (Switched Smoke Power), terminal 5 (Auxiliary 2 Power), terminal 7 (Keypad/Auxiliary 1 Power), and connector J15. To determine the maximum number of control stations per system, add the total continuous current drains upon terminals 3, 4, 5, 7, and J15 and add 50mA for each control station to be used. This total should not exceed the limits as indicated in Table 10, page 42.

Z900ST/Z900R/Z700R KEYPAD WIRE COLOR	FUNCTION	Z900 CONTROL TERMINAL
BLACK	NEGATIVE	6
RED	POSITIVE (+12VDC)	7
GREEN	DATA IN (REMOTE)	8
WHITE	DATA OUT(REMOTE)	9

TABLE 2 Z900 CONTROL STATION WIRING

CONTROL STATION MOUNTING

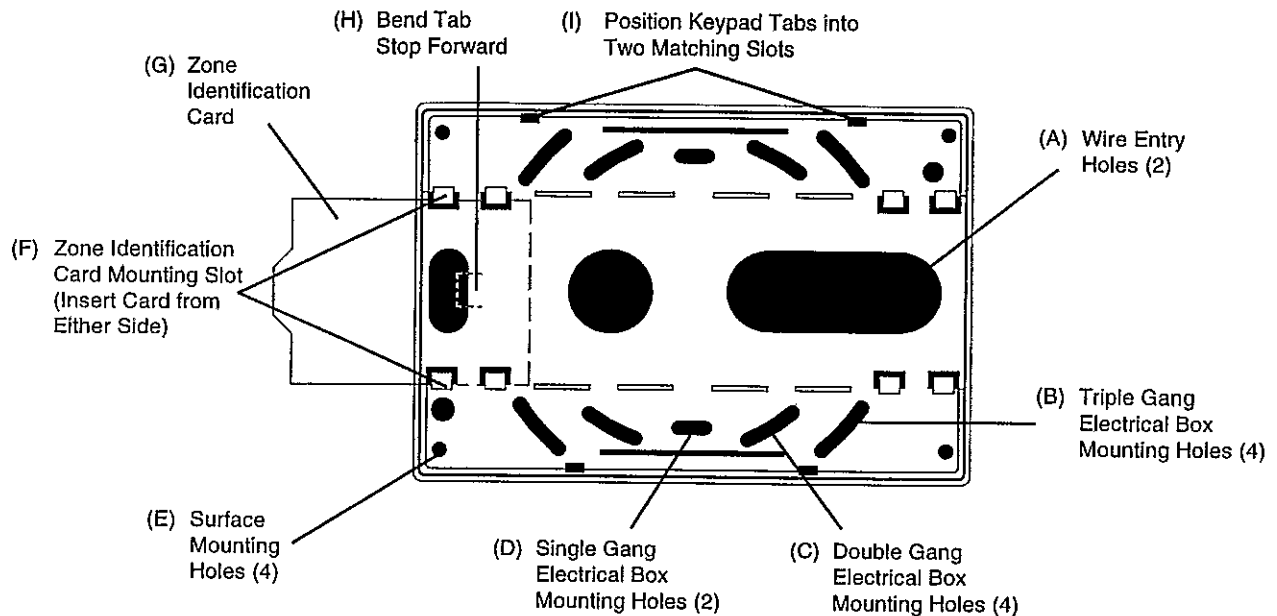

1. Bring wires through mounting holes (A).
2. Fill out Zone ID Card (G) and slide into the mounting slot tabs on the left or right side of backplate (F).
3. Bend the tab stop (H) forward.
4. Screw backplate to electrical box (holes B, C, or D), or screw to anchors (holes E).
5. Wire the control station.
6. Position the tabs on the top edge of the control station into the indentations under the inside top edge of the backplate (I).

FIGURE 9 Z900R MOUNTING

❑ TROUBLESHOOTING

If a control station is incorrectly wired, the following symptoms will appear:

Red Wire removed or cut: No control station LED's. Sounder pulses rapidly. Control station will not accept key entries.

Black Wire removed or cut: All control station LED's flash rapidly. Sounder pulses rapidly. Control station will not accept key entries.

Green Wire removed or cut: Trouble LED lights steady. Control station will not accept key entries.

White Wire removed or cut or Green/White Wires reversed: Control station LED's scroll from bottom to top.

CONTROL BOARD FUSES

❑ FUSE F1

Fuse F1 is a 5mm x 20mm, 2.5 Amp, standard acting fuse. It is used to protect the Auxiliary 2 (terminal 5) output and the Assignable Output (terminal 3). If this fuse should ever blow, the control stations' "Trouble" LED will light. Upon pressing and holding the "2" Key for three seconds, the Zone 2 LED ("Low battery/Blown fuse") will light. The communicator will report a "Low battery/Blown fuse" condition to the central station (if so programmed).

❑ FUSE F2

Fuse F2 is a 5mm x 20mm, 2.5 Amp, standard acting fuse. It is used to protect the Keypad Power/Auxiliary 1 output (terminal 7) and Switched Power (terminal 4). If this fuse should ever blow, the control stations will become inactive but the communicator, if programmed, will report a "Low battery/Blown fuse" condition to the central station.

❑ BATTERY LEAD FUSE

A 4 Amp "pigtail" fuse is provided in the positive battery lead to protect the battery. If this fuse should blow, the printed circuit board must be returned to the factory for repair.

Z900 Specifications and Instructions

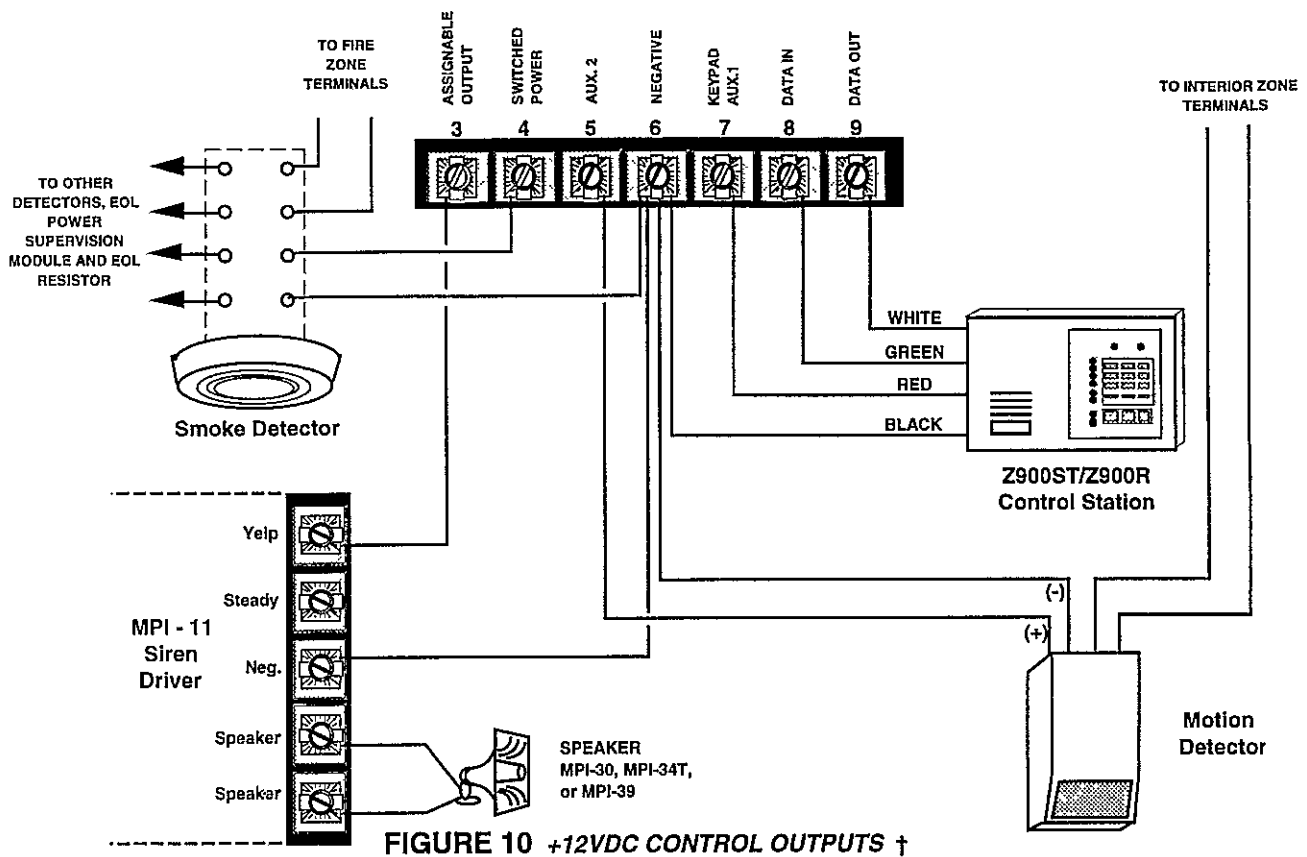

FIGURE 10 +12VDC CONTROL OUTPUTS †

12 VDC OUTPUTS

The control is supplied with one Assignable output, two Auxiliary Power outputs, and one Switched Power output.

□ SWITCHED POWER (Terminal 4)

Provides (+)12volts DC power for smoke detectors (see *ff* note on page i) and other devices that require momentary power interruption to reset. The power from this output can be momentarily interrupted to reset smoke detectors by pressing the “7” key and holding for three seconds. Each time the control does an automatic 24 hour test, power from this output will be removed for 5 seconds. For this reason, Switched Power should not be used to power any device that will trigger an alarm upon interruption and restoration of power. This output is fused at 2.5 amperes by fuse F2 which is also used to fuse the Keypad Power/Auxiliary 1 output (terminal 7). Do not exceed the current drain limitations as indicated in Table 10, page 42. See Figure 10 for a hook-up example.

□ AUXILIARY 2 (Terminal 5)

Used to provide (+)12 volts DC power for motion detectors and other devices requiring uninterruptable power. This output is protected by a 2.5 ampere fuse (F1) which is also used to fuse the Assignable Output (terminal 3). Do not exceed the current drain limitations as indicated in Table 10, page 42. See Figure 10 for a hook-up example.

□ KEYPAD POWER/AUXILIARY 1 (Terminal 7)

Used to supply (+)12 volts DC power for control stations. This output is fused at 2.5 amperes by fuse F2 which is also used to fuse the Switched Power output (terminal 4). This output may also be used to supply auxiliary power for motion detectors and other devices provided the total current draw does not exceed the limits as set by Table 10, page 42. See Figure 10 for a hook-up example.

† Maximum continuous current drain from terminals 3, 4, 5, 7 and connector J15 should not exceed the limits as specified in Table 10, page 42. Maximum current drain under alarm conditions should not exceed 1.5 Amps. When replacing fuses, always use 5 x 20 mm, 2.5 Ampere standard acting fuses.

□ ASSIGNABLE OUTPUT (Terminal 3)

Assignable through programming (Function 256) to provide a (+) 12volt DC output upon any or all designated alarm conditions. If this output is not used for output upon alarms, it may be assigned to any ONE of the following other conditions: Switched Power reset (key 7)/24 hour automatic tests, access activation, supervisory/trouble conditions, or entrance pre-alarms and chime (key 6). If used to provide output upon alarms, it then must be defined as to the type of alarm condition(s) that will activate this output. This may include Burglar, Auxiliary "A", Auxiliary "B", or Auxiliary "C" alarms (or any combination) as selected through programming Functions 257-260. Sirens, bells, or other output devices may be connected directly to the Assignable Output (terminal 3) of the control provided they do not exceed the current drain limitations as indicated in Table 10, page 42. It may be desired to use this output for non-alarm conditions when using the optional Z729 Siren Driver/Output Expander. This output is protected by a 2.5 ampere fuse (F1) which is also used to fuse the Auxiliary 2 output (terminal 5). See Figure 10, page 10 for a hook-up example.

Value Programmed (Function 256)	+12VDC Output from Terminal 3 upon:	Value of "1" Programmed in Function:	The Following "Alarm Conditions" Provide +12VDC Output:
0	Alarm Condition(s) as determined by Functions 257-260		
1	Sw. Power reset (Key 7)/Auto Tests	257	Burglary
2	Activation of Access	258	Auxiliary "A" (Fire ff)
3	Supervisory/Trouble Conditions	259	Auxiliary "B" (Police)
4	Entrance pre-alarms and Chime	260	Auxiliary "C" (Emergency)

TABLE 3 ASSIGNABLE OUTPUT (Terminal 3) DEFINITION

□ ADDITIONAL OUTPUTS

Additional alarm outputs and various other function outputs may be accessed by plugging in an optional Z729 Siren Driver/Output Expander into connector J15 at the top of the control board.

The Z729 Siren Driver/Output Expander provides a built-in two channel high power siren driver, additional access to common(-) and Auxiliary 1(+), and 10 other outputs to include: individual output for each type of alarm (Burglar, Auxiliary "A", "B", and "C"), plus "Armed", "Ready", "Violation", "Pre-Alarm", "Lamp" and "Access". Each output provides 40 milliamps maximum current at 12 Volts DC and may be used to trigger low current relay boards such as the MPI-206 Relay Board, or any device that either consumes less than 40 mA or that has a low current trigger input. A 12 pin plug in type connector with color coded flying leads is provided. These outputs are identical to those provided by connector J16 on all Z1100 series control panels. The built-in siren driver is preconfigured to provide "yelp" output for Burglar and Auxiliary "B" (Police) alarms and steady sound for Auxiliary "A"(Fire ff) and Auxiliary "C" (Emergency) alarms.

□ CONTROL STATION ACTIVATED PANIC ZONES

The control is provided with three control station activated emergency panic zones. Three panic keys are provided on Z900R keypads for (from left to right) Auxiliary "A"(Fire ff), Auxiliary "B"(Police), and Auxiliary "C"(Emergency) alarms. Each zone is activated by pressing its designated key and holding for three seconds (or pressing at least twice within three seconds). If desired, the control can be programmed to respond to single momentary keypresses by programming a value of "0" into Function 271. To report the conditions to the central station, program Functions 74-76 (Tel. No. 1) and/or 127-129 (Tel. No. 2). To disable a emergency zone from operation, program a value of "1" into Function 261 (disable panic key Aux."A"), 262 (disable panic key Aux."B"), and/or 263 (disable panic key Aux."C"). To activate the Assignable Output (terminal 3), Function 256 (Assignable Output Definition) must be programmed with a value of "0" (activates upon Alarm conditions) and at least one of Functions 258-260 must be programmed with a value of "1" to address the type of alarm that will cause the Assignable Output to activate (see Table 3 above).

TELEPHONE LINE CONNECTION (TERMINALS 19 - 22)

Terminal 19 and 20 are the inputs for the incoming telephone line. Terminals 21 and 22 are outputs which go to the house phones. The telephone line runs through a line seizure relay within the control. Whenever the control is idle, this relay completes the connection. When the control needs to communicate with the central station, this relay disconnects the house phones from the system, leaving only the communicator connected to the incoming lines. This prevents communication interruption caused by picking up of a house telephone within the protected premises. For proper installation and to meet FCC requirements, an approved USOC RJ-31X or RJ-38X "Telephone Jack" and a mating 8 pin modular "Direct connect cord" must be installed. The purpose for this is to provide an isolation and disconnection point between the local telephone system and the control's Digital communicator for telephone company troubleshooting. An RJ-38X jack is a standard RJ-31X jack with a jumper installed between terminals 2 and 3 to allow a tamper loop for supervising the connection (See Figure 4, page 4). When ordering either jack the telephone company will need the following information:

1. Required Jack: USOC RJ-31X OR RJ-38X.
2. The telephone number of the line that jack is to be installed on.
3. Requested location at which jack is to be installed.
4. Digital communicator. FCC Registration Number (see Interconnect Label on Enclosure).
5. Ringer Equivalence: 0.0B

NOTE: The Ringer Equivalence Number (REN) is useful to determine the quantity of devices you may connect to your telephone line and still have all of those devices ring when your telephone number is called. In most cases, but not all areas, the sum of the RENs of all devices connected to one line should not exceed 5.0. To be certain of the number of devices that you can connect to a line in your area as determined by the REN, contact your local telephone company.

6. Equipment manufacturer: Sentrol, Inc.

NOTE: Refer to the inside back cover of this manual for FCC Compliance and additional telephone company information.

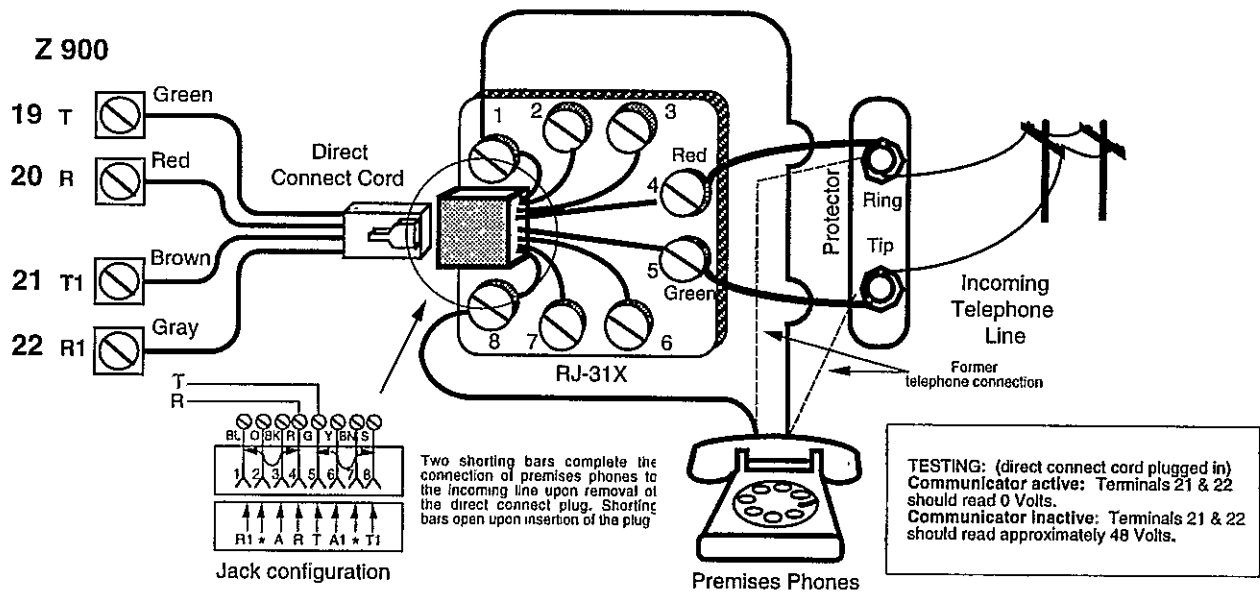

FIGURE 11 TELEPHONE SYSTEM CONNECTION

Operating the System

2

POWERING UP THE CONTROL

Before powering up the control, make certain that all connections are complete. This section assumes that the preceding sections have been read completely, that all wiring is complete, and the system is ready to be powered-up.

PROCEDURE

First, verify that the AC transformer and battery are plugged in and connected. The control will also power up with DC power only but the "Trouble" LED will light to indicate an "AC Failure" condition. The control stations will now display system status and emit a 2 second tone. If a control station does not power-up properly, pressing the " * " key will reset the control station microprocessor and allow it to begin working properly.

□ WATCHDOG MONITOR

The watchdog monitor is a circuit that constantly monitors the operation of the microprocessor and keeps it working properly. For example, if the control does not power-up properly, or if an internal problem occurs, the watchdog monitor will perform a restart of the microprocessor. A ROM and EEPROM check is then automatically made and the system returns to the same operating condition that it was in with the following exceptions:

1. If the system is armed, the control will ignore all burglar defined zones for fifteen (15) seconds (or as programmed in Function 188) once the watchdog restarts the microprocessor.
2. If the system is in alarm, the alarm output will cease and the control will re-arm.
3. If the system is communicating, the communication will be lost with the exception of alarm reports. Alarms are stored in non-volatile memory and will be re-transmitted.
4. The automatic communicator test clock will be reset to zero. If the system is programmed for test reporting, the test report will be sent when the system resets; thus notifying the central station of an out of sequence test. The test time reporting code is optional and is disabled from the factory.

□ AUTOMATIC SYSTEM DIAGNOSTICS UPON POWER-UP

Each time power is applied to the control, power-up diagnostics check the Read Only Memory (ROM) and the Electrically Erasable Programmable Read Only Memory (EEPROM). The EEPROM check is also made each time the control is armed/disarmed and during automatic communicator tests. The ROM check consists of compiling a checksum of all the ROM bits and comparing the results with the checksum produced when the ROM was manufactured. A difference in the ROM will lock up the microprocessor and cause the control station LEDs to scroll, from top and bottom to center. If this should occur, the microprocessor is defective and the control board must be returned to the factory for replacement. The EEPROM check consists of compiling a checksum of all the bits in the EEPROM and comparing this with the checksum generated when the EEPROM was last programmed. A difference in the checksums will result in a memory error. This condition will be annunciated by a continuous beeping at the the control stations and an illuminated "Trouble" LED. Pressing the "2" key and holding for three seconds will cause the Zone 5 ("Memory Error") LED to illuminate. The beeping of the stations may be silenced by pressing the " * " key. When an error has been detected, the Function Map should be read to determine the location of the change in information. The lighted "Trouble" LED on the control station will clear upon proper exiting of the programming mode.

PROCESSING OF ALARMS FOLLOWING TOTAL POWER LOSS

If a total power loss occurs (both AC and Battery) while the control is armed, the control will ignore all burglar defined zones for fifteen (15) seconds once the power is restored. The delay is to allow time for devices such as motion detectors, glass break sensors, etc., to power-up and stabilize. This time may be increased to 181 seconds (Function 188) if necessary to accomodate detectors which require longer stabilization time. This time is also started whenever the microprocessor is reset by the watchdog circuit. If a total power loss occurs while the digital communicator is transmitting, any hardwire activated zone alarms which have been stored in the EEPROM will be reported upon power restoral.

NOTE: Keypad activated alarms as well as supervisory/trouble, opening/closings, restorals, cancels, and test reports are not stored in EEPROM and therefore, will be lost in the event of total power loss.

THE Z900R CONTROL STATION

The Z900R was designed with ease of user operation in mind. A red "Armed" LED blinks upon exit delay and lights steady when the control arms. A green "Ready" LED lights steady if all hardwire zones are secure (even if faulted zones are shunted) and goes out if one or more zones are faulted. Each hardwire zone has a corresponding zone status indicator. If the green "Ready" LED is off, the corresponding faulted zone LED(s) will light. If a zone is shunted, the corresponding zone LED will blink, even if shunted by turning the interior defined zones off (see "Interior ON/OFF"). A separate "Alarm" LED illuminates simultaneously with the alarmed zone LED to provide alarm memory identification. A "Trouble" LED lights if service is required (a blown fuse, communication failure, EEPROM error, etc.). (See "Defining 'Trouble' Conditions", page 16). Arming and disarming is accomplished by entering a four digit code. Up to six *User Authorization Codes* may be programmed. Each code may include any digit sequence from 0001 - 9999. User Authorization Code one is the *Master User Authorization Code*. This code is also used to provide access to *User Level Programming*. Any code may be further defined as a *High Security Arm/Disarm Code*. When the system is armed with a High Security Arm/Disarm Code, the system cannot be disarmed by a non-high security code.

CONTROL STATION POWER-UP and SUPERVISION

Upon installation and power-up, each control station should be initialized with the control by manually pressing the " * " key. If a control station data wire is then tampered with, mis-wired, or broken, or if a control station is disconnected from the main control, the "Trouble" LED on any remaining controls stations will light. Pressing the "2" key (on an active control station) and holding for three seconds will cause the "Zone 3" (supervisory) LED to light. The digital communicator can also be programmed to report this condition to the central station. If the faulted control station still has power connected, the control station LEDs will scroll from bottom to top for local identification.

USER OPERATION

□ ARMING/DISARMING

Performed by simply entering an authorized four digit user code. Upon arming, the control station sounder will beep during the programmable exit delay time (Function 13). Upon entering the premises through a delay defined zone, the control station sounder will emit a steady pre-alarm tone during the programmed entrance delay time (Functions 11 and 12). The entrance and/or exit delay annunciation may be disabled if desired by programming odd time values. The arm/disarm codes are also used to reset all Auxiliary alarms and the control station activated zone. User codes (Functions 1-6) are programmable through User Level Programming only.

□ ALARM STATUS

If an alarm occurs, the "Alarm" LED will light and remain lighted until manually reset. If the alarm was triggered through a hardwired zone, the corresponding zone LED(s) will also light. For example, if an alarm occurs on Burglar Zone 4, then the "Alarm" LED and the "Zone 4" LED will illuminate. Upon disarming the control, these LEDs will remain lighted. Simply pressing the " * " key will turn the "Alarm" LED off. If the alarm was triggered through one of the control station activated zones, the red "Alarm" LED will light but no individual Zone LED will light, indicating that a non-hardwired zone alarm has occurred. Entering a valid user code will clear the alarm. Alarm memory information may be recalled even after resetting the alarm (see "Alarm Memory Retrieval", page 18).

□ MANUALLY RESETTING ALARMS

Burglar alarms:

The alarm may be reset by entering a valid user code. The communicator will continue to report the condition to the central station (if programmed) unless programmed to abort upon disarming (Function 54). The "Alarm" LED will remain lighted until reset by pressing the " * " key.

Auxiliary "A" (Fire ff) alarms:

Pressing the " * " key will silence the control station sounder. The Auxiliary "A" (Fire ff) alarm, which may be provided through the Assignable Output (terminal 3) and/or the Z729 Siren Driver/Output Expander, will also cease. The "Alarm" LED will remain lighted and the communicator (if programmed) will continue to report to the central station. Entering a valid user code will clear the alarm.

Auxiliary "B" (Police) alarms:

Pressing the " * " key will silence the control station sounder. The Auxiliary "B" (Police) alarm, which may be provided through the Assignable Output (terminal 3) and/or the Z729 Siren Driver/Output Expander will not be reset by pressing this key. Entering a valid user code will reset the alarm.

NOTE: To select silent keypad panic for auxiliary B on the Z900, you must enter a value of 1 for memory address 201 (silent keypad audible on Auxiliary B alarm output) and a value of 0 for memory location 271 (keypad panic three-second hold mode). If the installer selects a value of 1 for memory location 271, the control station will emit a single beep regardless of the value in location 201.

In addition, memory location 259 (assignable alarm output) should be programmed with a value of 0 if you wish the alarm output (terminal #3) to remain inactive during Auxiliary B alarm conditions. This will not affect its operation during other types of alarm.

Auxiliary "C" (Emergency) alarms:

Pressing the " * " key will silence the control station sounder. The Auxiliary "C" (Emergency) alarm, which may be provided through the Assignable Output (terminal 3) and/or the Z729 Siren Driver/Output Expander, will also cease. The "Alarm" LED will remain lighted and the communicator (if programmed) will continue to report to the central station. Entering a valid user code will clear the alarm.

CONTROL STATION ACTIVATED PANIC ZONE OPERATION

The control is provided with three control station activated zones. Each zone is predefined for the type of alarm which it can initiate and is activated by pressing its designated emergency key. For added protection against false alarms, the control is programmed to ignore momentary keypresses and require a three second maintained keypress (or at least two momentary key presses within three seconds). If desired, the control can be programmed to respond to single momentary keypresses by programming a value of "0" into Function 271. The left most key is predefined to initiate an Auxiliary "A" (Fire ff) alarm, the center key can initiate an Auxiliary "B" (Police) alarm and the right key an Auxiliary "C" (Emergency) alarm. Self-adhesive labels are included with the control station for labeling these keys with symbols to indicate Fire, Police, and Medical conditions. Any or all control station zones may be disabled through programming (Functions 261-263). The Assignable Output (terminal 3) may be programmed to provide +12VDC upon activation and the communicator may also be programmed to report (refer to "Control Station Zones", page 11 for more information).

When a control station zone is activated, the station beeps and the "Alarm" LED lights. The control station may be silenced by pressing the " * " key. If the zone is defined as an Auxiliary "A" or "C" zone, pressing the " * " key will also silence the Assignable Output (terminal 3) and the output from the optional Z729 Siren Driver/Output Expander, if so assigned. The alarm may be reset by entering a valid user code. The control station activated zone may be programmed to report the alarm to the central station. Auxiliary "B" may be programmed to be visually and audibly "silent" at the control station when activated.

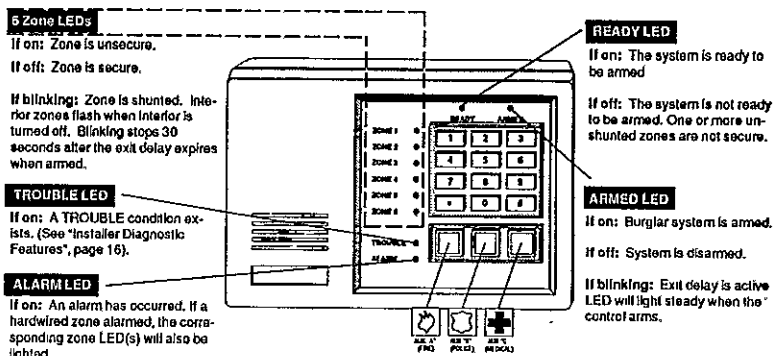

FIGURE 12 Z900R CONTROL STATION LEDs

ZONE SHUNTING (BYPASSING)

Hardwire Burglar zones may be manually bypassed by pressing the " # " (SHUNT) key followed by the number of the zone to be shunted. Auxiliary "A", "B", and "C", zones may be defined with the sub-option to allow them to be shuntable also. The control must be disarmed before shunts can be enabled. When zones are shunted, the appropriate "Zone 1-6" LED(s) will blink continuously. Pressing " # " followed by the number of a shunted zone will remove the shunt. Pressing " # " followed by "9" will remove all shunts. When the control is armed, the shunted zone LEDs will only blink for the first 30 seconds after the exit delay expires then go out. Zone shunting capability can be disabled through programming (Function 195).

INSTALLER DIAGNOSTIC FEATURES

Certain control station keys provide access to special features designed primarily for use by the installer. However, the installer may at his or her discretion, explain certain available features to the user when necessary. Table 5, page 17 lists these features. Diagnostic information is obtained through the control station by pressing specific keys. Information is displayed through combinations of illuminated LEDs. Features accessed through keys 4, 6, 7, 8, and “ * ” may be disabled through installer programming. The Diagnostic Overlay template (supplied) aids in defining specific trouble conditions, alarm memory conditions, and zone definition.

□ IDENTIFYING “TROUBLE” CONDITIONS (KEY 2)

If a trouble condition exists, a “Trouble” LED will illuminate on the control stations. Pressing and holding the number “2” key for three seconds will cause one or more of the zone LEDs to light. Each zone LED corresponds to a specific “Trouble” condition. This procedure is simple enough to be performed by the user and communicated to the installer over the telephone for diagnosis. Table 4 explains the indicated conditions.

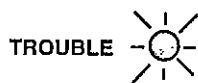

If the “Trouble” LED is lighted, press and hold the “2” key for three seconds. The control stations will beep three times and one or more zone LEDs will light to indicate the nature of the “Trouble” condition as explained below:

LIGHTED LED	INDICATED CONDITION/CORRECTIVE ACTION REQUIRED
ZONE 1	AC Power Failure. Check transformer terminals 1 and 2 for presence of 16.5 VAC (no load) power.
ZONE 2	Low Battery/Blown Fuse. Check fuses F1 and F2 and condition of standby battery.
ZONE 3	Supervisory/Trouble. A supervisory defined zone is shorted or open (depending upon programming of Function 203-208).
ZONE 4	Fail to communicate. The control attempted to communicate with the central station but failed. Press the “*” key to silence the control station sounder. See Function 48, page 27 for more information.
ZONE 5	Memory Error. Program information stored in the EEPROM has changed. See “Powering Up The Control”.
ZONE 6	Missing Keypad. A control station data wire has been removed from the control.
	<i>The following conditions do not require the “Trouble” LED to be lighted. Press the “2” key and hold for three seconds in the same manner as above to obtain the following ON or OFF LED indications:</i>
ALARM	Chime on. The Chime (Monitor) feature is active.
READY	Interior OFF. The interior defined zones are turned OFF (bypassed). They may be reinstated by pressing and holding the number “4” key for three seconds. Turning the interior off may also automatically disable the entrance delay, if so programmed (Function 191).
ARMED	Delay OFF. The Entrance Delay assigned to Entrance Delay 1 and 2 defined zones has been turned OFF simultaneously with the interior. This is a selectable programming option (see Function 191).

TABLE 4 TROUBLE DEFINITION

KEY NUMBER	FEATURE PROVIDED
2	Trouble Status: If a problem exists within the system, a dedicated control station LED labeled "Trouble" will light. Pressing and holding this key for three seconds will cause one or more control station LED's to light to further define the trouble. This function exits automatically after 8 seconds of no key entries. See page 16.
3	Alarm Memory: Pressing and holding this key for three seconds will obtain a display identifying the zone that triggered the last alarm condition (see page 18). Upon entry of this mode, the control stations will beep three times. The control automatically exits this mode after eight seconds. Programming Function 009 clears Alarm Memory.
4	Interior ON/OFF: All Interior defined zones may be shunted by pressing and holding the number "4" key for three seconds. The corresponding Interior defined Zone LEDs will then blink to indicate that they are shunted. (See "Zone Shunting", page 15). These zones are returned to operation by repeating the process. The control stations beep three times whenever this feature is turned on or off to notify the user of system acceptance. The entrance delay may also be automatically disabled whenever the interior is turned off depending upon programming of Function 191. The interior and delay on/off status may be verified by pressing and holding the "2" key for three seconds. If the interior is selected off, the green "Ready" LED will light. If the Delay is off, the red "Armed" LED will also light. Upon disarming the system, the interior zones may be automatically defaulted to on or off (along with the delay if so programmed) depending upon programming of Function 194. The Interior on/off key may be disabled through installer programming (Function 196) if desired.
5	Delay/Instant Toggle Using Key 5: It is now possible to toggle the Delay/Instant mode prior to arming by pressing and holding key 5 for 3 seconds. The control responds with 6 beeps when the instant mode is activated, and 2 beeps if changed back to delay. When the Instant mode is activated, the Armed LED lights steady (no exit blink) immediately after arming. In addition, key 4 may still be used for turning the Interior On or OFF. The programming function (#196) that allows key 4 to be disabled will also disable key 5 if selected.
6	Chime: Pressing and holding the number "6" key for three seconds will activate the Chime (Monitor) feature. The control stations will beep three times to signify that the Chime has been turned on. When enabled, the control stations will beep twice whenever a non-interior Burglar defined zone is violated (with the control disarmed). This is commonly used as a door chime on commercial applications and to indicate that children have opened a door or window on residential applications. The Chime is turned OFF by repeating the process. The control stations will beep twice to signify that the Chime has been turned OFF. The Chime feature may be disabled through programming (Function 197) if desired.
7	Switched Power Interrupt: Pressing and holding this key for three seconds will cause the control to temporarily interrupt the output from Switched Power (terminal 4) for five seconds, in order to reset smoke detectors and other latching devices. Switched smoke power should not be used to power devices that may trigger an alarm upon interruption and restoral of power as power is momentarily removed once every 24 hours when the automatic system test is performed. This feature may be disabled through programming (Function 198).
8	Test: Press and hold this key for three seconds to enter the Test mode. The control stations will beep three times to signify entry. Each time a zone is violated, the corresponding zone LED will light and remain lighted until manually exiting this mode. This allows for a "tally" of zones tested. This mode is exited by pressing and holding the "8" key once again or pressing the " * " key. The manual test feature may be disabled through programming (Function 199).
9	Program: Used to enter the programming mode. See Section 3 for more information.
0	Access: Press and hold for three seconds then enter an assigned user code to provide an output for Access (door release, etc.). To enable this feature a user code must be assigned a Configuration Digit of 2, 3, 5, or 7 (Function 34-39). The output may be obtained through the Assignable Output or optional Z729 Siren Driver/Output expander.
*	Reset: Used to clear improper key entries and to reset certain alarms (see page 14-15).
#	Zone Shunting: Zones may be shunted (bypassed) easily by pressing the " # " followed by the zone number (1-6) of the zone to be shunted. Pressing " # " then " 9" will remove all shunts. The shunting feature may be disabled through installer programming (Function 195) if desired. See page 15 for more information.

TABLE 5 SPECIAL CONTROL STATION FEATURES

Z900 Specifications & Instructions

□ ALARM MEMORY RETRIEVAL (KEY 3)

When an alarm condition occurs, the control stores a record of the alarm in memory. This information may be retrieved even after the alarm has been reset and the control station "Alarm" LED has been extinguished. To obtain a display indicating the most recent alarm, press and hold the "3" key for three seconds and observe the lighted LEDs. Use the Diagnostic Overlay card (supplied) to determine the type of alarm and the hardwire zone(s) (if applicable) that activated. The display will return to the normal status mode after eight seconds. Alarm memory conditions are displayed as follows:

Burglar alarm - The "Armed" LED will light. If the alarm was activated through a hardwire zone, the appropriate zone LED(s) will also light.

Auxiliary "A" (Fire *ff*) Alarm - The "Alarm" LED will light. If the alarm was activated through a hardwire zone, the appropriate zone LED(s) will also light.

Auxiliary "B" (Police) Alarm - The "Ready" LED will light. If the alarm was activated through a hardwire zone, the appropriate zone LED(s) will also light.

Auxiliary "C" (Emergency) Alarm - The "Trouble" LED will light. If the alarm was activated through a hardwire zone, the appropriate zone LED(s) will also light.

When another alarm condition occurs, the memory will be erased and replaced by the current information.

Programming the Control



All programming is stored in nonvolatile “EEPROM” memory. The control is shipped with a factory (default) program already installed. All programming options are referred to as Functions. The *Program Function Map* is a list of all *Functions* complete with their factory default values.

User Level Programming provides access to Functions 1-33, which primarily pertain to the everyday operation by the end user. The *Master User Authorization Code* (User Code 1) is required to enter the user level programming mode. This code also functions as a normal user code to arm/disarm and reset alarms. This code can only be changed through user level programming.

Installer Level Programming provides access to all installer level programming Functions (34-266) and user level programming Functions 7-34.

All Functions are listed in numerical order in the *Program Function Map*, complete with their factory default values and space provided to enter new information.

Both levels of programming may be entered locally from any control station. In addition, the control may be programmed remotely with the aid of a personal computer (see “Remote Programming”, page 23). To reduce on the job installation time, the program may be copied and transferred from other Z900 controls with an optional hand held MPI230 Chip Duplicator. The system may be easily returned to factory default at any time (see “Restoring the Factory Default Program”, page 21).

INSTALLER LEVEL PROGRAMMING

INSTALLER PROGRAM AUTHORIZATION CODE

To enter the programming mode, press the “9” key and hold for three seconds. The control will beep three times to signify acceptance. Now enter the Installer Program Authorization Code (96321 at default). All control station LEDs will blink continuously.

NOTE: If the first four digits of the Installer Program Authorization Code are programmed the same as any User Authorization Code (Functions 1-6), the Installer Program Code will be inoperative.

ENTERING INSTALLER LEVEL PROGRAMMING UPON POWER-UP

Upon power-up, the Installer Level Programming Mode may be entered directly by pressing keys “3” and “9” simultaneously. This must be performed within 60 seconds after applying power to the control. The power-up method may also be used when the Installer Program Authorization Code is unknown.

THREE MINUTE PROGRAMMING TIMER

A three minute timer is started upon entry into the programming mode. If no keys are pressed for a duration of three minutes while in the programming mode, the control will emit a two second error tone and the control will return to the normal operation mode.

PROGRAM FUNCTIONS

All programming options are called Functions. Each contains a specific value, which serves as an instruction to the control. Programming changes are accomplished by entering new values into chosen functions. The allowable *range* of a value contained in each function varies according to the specific type and purpose. For instance, most of the timer related functions (entry/exit, alarm cutoff, etc.) deal with either seconds or minutes and have a range of 1-255. Functions that are associated with the digital communicator such as the account number, report codes, and telephone number have a range of 1-15. Many functions are questions requiring a simple yes or no response. Since the microprocessor accepts only numbers, answers to these type functions must be in the form of a “0” for No or a “1” for Yes. The Program Function Map and Programming Functions and Descriptions sections provide additional information about each function as well as the allowable range of values.

THE “ # ” (FIND) AND “ * ” (STORE) KEYS

Two special keys are used while in the programming mode. They are the “ # ” (FIND) and “ * ” (STORE) keys. While in the programming mode, any program function may be accessed by pressing the desired function number using the numeric keys and then pressing the FIND key. This key also serves as a (NEXT) key. When pressed without first pressing any of the number keys, the “#” key will advance programming to the (NEXT) consecutive function.

Example: Pressing 4 + 5 and then FIND jumps to program Function 45 and displays its current value.



After “finding” a program function, the value (data) which it contains will be displayed on the LEDs. The value may be changed by pressing the desired new value using the keys 0 - 9 and then pressing the STORE key. This key also serves as a (QUIT) key. When pressed without first pressing any of the number keys, the “ * ” key will automatically exit the programming mode.

Example: Pressing 7 + 3 and then STORE changes the current program Function value to a value of 73.



READING THE VALUE OF A FUNCTION

While in the programming mode the control stations display the value that is stored within each Function. Values are displayed in combinations of lighted LEDs on the control station. Using the Diagnostic Overlay card (supplied), read the values printed next to each lighted LED (“Key 3” side of card). The value for the currently displayed Function is determined by adding these values (see example below).

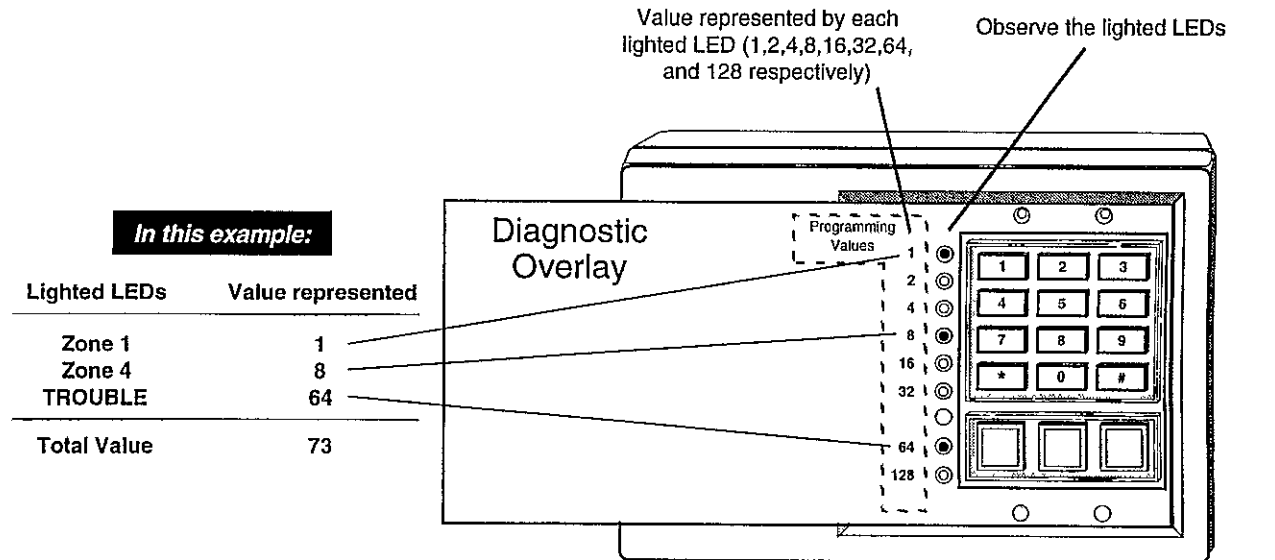

FIGURE 13 READING THE VALUE OF A FUNCTION

ZONE PLANNING GUIDE

Zones are programmed by selecting the desired zone type and definitions using the Zone Planning Guide (page D) as a worksheet. Each definition has a specific numeric value. After all selections are made, the individual values are added together and the total equals the value that should be programmed into the function for that zone.

PROGRAM FUNCTION MAP

Provides a list of each Function, its factory default value, and a blank space to write in any changes that may be desired. The map may be removed from the book and left inside the control for future references.

EXITING THE PROGRAMMING MODE

Pressing the “ * ” key twice exits programming mode.

INSTALLER LEVEL PROGRAMMING EXAMPLE



1. Press 9 and hold for three seconds. Three beeps.

2. Enter the Installer Program Code. (96321 at default) All LEDs flash.

NOTE: If Auto Answer is enabled, the Armed LED will light steady (See p.23).

3. Enter the desired Function number (1-3 digits). The current Function value will be displayed through the LEDs.

NOTE: Ready and Armed LEDs continue to flash alternately throughout the programming mode.

4. Press “FIND”. Two beeps. The value of the selected Function will be displayed through the LEDs.



5. Enter the new value. (A “1” represents “Yes” in this example. Possible entries vary for different Functions)

6. Press “STORE”. Two beeps. The new value is now stored in the EEPROM.

7. Press “NEXT” to step to the next location, or enter a new Function number followed by this key to “FIND” the selected Function.

8. Press the “ * ” key twice to exit the programming mode.

NOTE: Upon power-up, the Installer Level Programming Mode keys (0, 8, 5, 2 and “*”) must be pressed within 60 seconds of power-up. This method may also be used when the Installer Program Authorization Code is unknown.

FIGURE 14 INSTALLER LEVEL PROGRAMMING EXAMPLE

RESTORING THE FACTORY DEFAULT PROGRAM

The controls' factory default program may be easily restored at any time. Restoring the factory defaults automatically resets all installer level and user level program functions to the original default (factory pre-programmed) values. Restoring the default settings provides a quick means of erasing any bench testing programming prior to final installation. If the Master User Code is forgotten and restoring the entire program to default values is not desired, it may be restored individually through program Function 250. Refer to the Function Map for a complete listing of the default values.

1. Enter the installer level programming mode by following steps 1 and 2 in the example above. If the code is unknown, press keys (0, 8, 5, 2 and “ * ”) within 60 seconds of control power up. The control station LEDs will flash indicating entry into the programming mode.
2. Enter Function 254 and press the “ # ” (FIND) key.
3. Enter a value of “1” and press the “ * ” (STORE) key. The first LED (Zone 1) should now be lighted.
4. Press the “ * ” (STORE) key twice to exit the programming mode. There will be a 5 - 10 second delay while the control restores the factory default values. During this time the control will not respond to other commands. After approximately 5 - 10 seconds, the factory default values will be restored and the control will return to normal operation.

USER LEVEL PROGRAMMING

User level programming provides access to programming functions which primarily pertain to the everyday operation by the user. Programming is performed in the same manner as with installer level programming with the following exceptions:

1. Access to user level programming is authorized by entering the Master User Authorization Code (User Code 1) rather than the Installer Program Authorization Code.
2. Programming is limited to Functions 1-33 only.
3. The “#” key will step to the “Next” digit of a multiple digit function (such as a user code) for reading the value of a function but this key will not advance programming to the “Next” Function. For example, after entering Function 002 (User Authorization Code 2), the first digit of the code will immediately be displayed. Pressing the “#” key will advance to digit 2. This digit is now displayed and the value can be determined. Repeat the process two more times to view digits 3 and 4. If pressed once more, user level programming is automatically exited.
4. Program mode is exited automatically after entering a new value.
5. The six user authorization codes (Functions 001-006) are accessible only through this level of programming.

MASTER USER AUTHORIZATION CODE

Along with performing normal Arm/Disarm functions, the Master User Authorization Code (Function 001) is also used to permit access to the user level of programming. This code is 1245 at factory default and may be changed to any other four digit code through user level programming. Do not use the same four digit code sequence as the first four digits of the Installer Program Authorization Code as this will make the Installer code inoperative. To enter the user level, press the 9 key and hold for three seconds. The control stations will beep three times to signify acceptance. Now enter the Master Program Authorization Code. All control station LED's will blink continuously.

USER LEVEL PROGRAMMING FORMAT

Perform user level programming in the same manner as explained earlier for installer level programming, substituting the Master User Authorization Code for the Installer Program Authorization Code. Functions 1-33 are accessible. Program mode is exited automatically after entering the new Function value.

USER LEVEL PROGRAMMING EXAMPLE

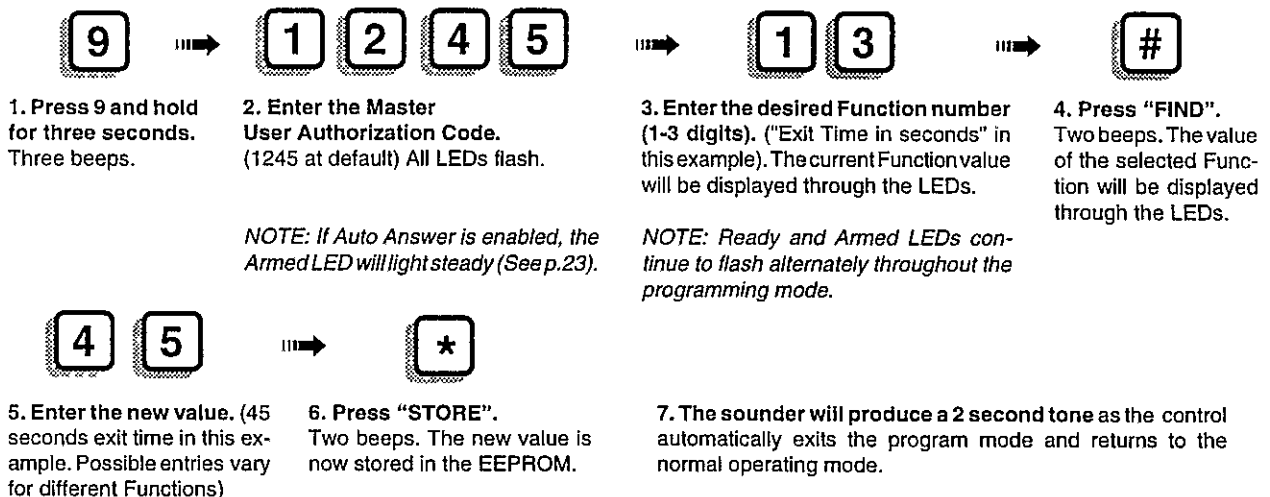

FIGURE 15 USER LEVEL PROGRAMMING EXAMPLE

SPECIAL PROGRAMMABLE FEATURES

REMOTE PROGRAMMING (UPLOAD/DOWNLOAD)

A powerful feature of the control is the ability to be re-programmed and/or controlled remotely over a standard telephone line using an IBM PC ® or compatible computer, a Hayes Smartmodem ® and the manufacturer's software package "TRANSPORT PC" ®. Each function of the control may be individually programmed while on line or the entire memory contents may be uploaded/downloaded with only a few keystrokes. An upload or download usually requires approximately 1 to 2 minutes. The software requires a licensing agreement contract. Contact the factory sales department for information. There are two methods of remote programming. The following is a description of each method along with the basic operation.

❑ ON-SITE "MANUALLY" ASSISTED METHOD

Establish a telephone connection between the computer site and the telephone that is connected to the control. Select the "Answer" mode on the computer. Instruct the individual at the control to press and hold the "9" key for three seconds and enter their Master Authorization Code (default is 1245). All keypad LEDs should be blinking. After this is done, they should then select Function 33 and press the "#" (FIND) key. The control will seize the phone line and the control will report its status to the computer. When this is complete the control will await any re-programming commands. This method is the most secure method of remote programming since it requires assistance at the control panel site.

❑ AUTO ANSWER AND CALLBACK METHOD

This method requires two programming Functions to be set in order to operate properly. (1) Program Function 160 (Rings until auto answer) must have a value of 1 - 15. A value of "0" will disable auto answer. (2) Functions 161 through 176 must be programmed with the callback telephone number of the computer. The Function following the last telephone digit must be a value of "15". In operation, the computer dials the telephone number of the control. Upon detecting the programmed number of rings, the control will answer the call and produce a handshake signal. If the proper computer response is received, the control will hang-up and dial the callback telephone number. When the computer answers the callback, various security procedures take place before any programming information can be exchanged. These include: a security access code, computer operator security code, computer operator levels of access, as well as logging of all computer transactions. If the control does not receive the proper computer response or if the callback is not answered within a preset time limit, the control will reset to regular operation. The control will make a second attempt if the first attempt fails. This method virtually eliminates computer hackers from gaining access to the control. The "Alarm" LED will illuminate steady whenever the program mode is entered, once this feature is enabled.

NOTE: Both methods of remote programming have extensive built-in security features; however none are as important as proper operator screening and training to reduce the liabilities involved with this feature.

❑ ANSWERING MACHINES

A Z233 Answer Command Module may be installed if the control is attached to a line which has a telephone answering machine. It allows the computer to signal the control when it wishes to communicate. When signaled, the control seizes the line and disconnects the answering machine. It then awaits for acknowledgement and makes the callback just as if it had answered the call.

SILENCE EXIT DELAY BEEP

The exit beep is silenced automatically when the system is armed with the interior off. This exit beep may be totally disabled by programming in an odd value when programming exit time (Function 13).

FORCE ARMING (See Program Function Descriptions, Function 178)

Z729 SIREN DRIVER/OUTPUT EXPANDER

The optional Z729 Siren Driver/Output Expander plugs directly into connector J15 at the top edge of the control board to provide a built-in two channel high power siren driver plus outputs for Access, Pre-alarm, Ready (loop status), Armed, Violation, Burglar alarm, Auxiliary alarms ("A", "B" and "C"), and Lamp (to trigger line carrier house lamp switching devices upon pre-alarms, power failures, etc.). Additional access is provided to the controls' common negative termination and Auxiliary 2 (+12VDC).

SUPERVISORY/TROUBLE ZONE SUB-OPTION

Supervisory/Trouble is a programmable zone sub-option which allows Burglar, Auxiliary "B", Auxiliary "C", Communicator report only, and Keyswitch defined zones to react to either an open loop or shorted loop as a trouble instead of an alarm. A choice must be made as to troubles on opens or troubles on shorts. Troubles on loop opens is the factory default if a zone is defined as supervisory/trouble. Upon detection of a supervisory condition the control station will beep and display visual information and report the condition to the central station receiver if so programmed. The control station will continue to display a supervisory condition as long as the condition exists. When the supervisory condition is cleared, the control station will automatically reset unless the control has been programmed for latching supervisory (see Function 186) in which case it will be necessary to press the "*" key to silence and reset the control station. These loops must be configured as end-of-line resistor supervised loops (see Figure 6, page7) if this option is selected. If any burglar defined zones are to be programmed with the supervisory/trouble option, Function 248 (Eliminate Burglar Zone EOL Supervision) must be programmed with a "0" (disabled).

SHUNTABLE 24 HOUR AUXILIARY "A", "B", "C", COMMUNICATOR, AND KEYSWITCH ZONES

The Auxiliary "A", "B", "C", zones, Communicator Report Only, and Keyswitch defined zones may be programmed as shuntable by adding a value of "32" to their base zone definition. Shunting may be performed manually utilizing the "# " key. Shunting of these zones may be valuable for servicing or in the event of a false alarming detection device.

NOTE: When an Auxiliary "A" (fire ff) zone is shunted, the control station will beep and display a supervisory/trouble condition. If the communicator is enabled and a code is programmed for supervisory/trouble reporting, a report will be transmitted. The control station can be silenced but the trouble condition will continue to be displayed until the shunt is removed and the zone secured.

PRIORITY (NON-SHUNTABLE) BURGLAR ZONES

For a higher level of security, all burglar zones can be individually programmed as non-shuntable. This is accomplished by adding "32" to the zone definition value when defining the zone.

HIGH SECURITY ARM/DISARM CODE

One or more of the user authorization codes may be programmed as a High Security Arm/Disarm Code by assigning a configuration digit of "4". Whenever the control is armed by a High Security Code, it can only be disarmed by that code or another High Security designated code. All other user codes are inoperable when the control is armed by a High Security Arm/Disarm Code.

GROUP SHUNTING

One or more zones may be shunted simultaneously with a feature called "Group Shunting". After observing the faulted zones, press the shunt key ("# ") followed by an entry of "0". The faulted zones will automatically be shunted and the control station will automatically display which zones were shunted by blinking the corresponding LEDs.

DIGITAL COMMUNICATOR

The control has a built in communicator that can dial two (2) different 16 digit telephone numbers using either rotary or touchtone @ dialing. The report codes for all zones and transmitted conditions are programmable for each telephone number. By programming both telephone numbers and report codes identically, each telephone number can back-up the other if unsuccessful. Certain conditions may also be "split" between two different telephone numbers by programming selected report codes for each telephone number. Dual reporting of alarm and/or non alarm conditions, whereby signals are transmitted to both central stations is also possible (Functions 50 and 51).

☐ TELEPHONE LINE SEIZURE

When the communicator is triggered, it seizes the telephone line, thereby disconnecting the house phones. Dial tone detection is then enabled. Once detected, rotary or touchtone@ dialing sequence begins, depending on programming of Function 67 and 120. If a dial tone is not detected within 10 seconds, the communicator hangs-up for the time set in Function 53 (factory default 3 seconds) and re-enables dial tone detection. If a dial tone is not detected within 10 seconds, the communicator will begin its dialing process anyway.

Z900 PROGRAM FUNCTION MAP

Factory Default Values For All Functions Are Shown In Brackets []. Valid Ranges Are Shown Inside { }.

USER LEVEL PROGRAMMING

User Authorization Codes. Use any four digits (0-9). Digits may repeat.	001 MASTER USER AUTHORIZATION CODE [1245] _____ program four digits for maximum security. 002 USER CODE 2 [FFFF] _____ 003 USER CODE 3 [FFFF] _____ 004 USER CODE 4 [FFFF] _____ 005 USER CODE 5 [FFFF] _____ 006 USER CODE 6 [FFFF] _____ "F's" indicate the code is deleted. USER CODE 1= Master User Authorization Code.
Counters, Timers, and Special Use Functions	007 USAGE COUNT CODE 06 [255] _____ {1-254, 255=permanent} 008 TIME UNTIL NEXT COMMUNICATOR TEST {0-24} _____ 009 CLEAR ALARM MEMORY {no value required} 010 DELETE CODES {1-6, 0 will delete the installer code} 011 ENTRANCE 1 TIME IN SEC. [30] _____ {1-255} 012 ENTRANCE 2 TIME IN SEC. [46] _____ {1-255} 013 EXIT TIME IN SECONDS [60] _____ {1-255} 014 ACCESS TIME IN SECONDS [5] _____ {0-255, 0 = LATCH} 015 DELAY BURGLAR OUTPUT IN SEC. [0] _____* 016 BURGLAR CUTOFF TIME IN MIN. [10] _____** 017 AUX "A" CUTOFF TIME IN MIN. [255] _____** 018 AUX "B" CUTOFF TIME IN MIN. [10] _____** 019 AUX "C" CUTOFF TIME IN MIN. [10] _____** * {0-255} ** {1-254, 0 or 255 = Never cutoff} 020 TIME BETWEEN COMM. TEST [1] _____ {0-7, 0 = 12 hours, 1-7 = 1 to 7 days} 021-032 EXITS TO PROGRAMMING ENTRY 033 BEGIN UPLOAD DATA {no value required}

INSTALLER LEVEL PROGRAMMING

Configuration Digits for User Codes 1-6 (0-15). Refer to Table 6.	034 CODE 1 [3] _____ 035 CODE 2 [3] _____ 036 CODE 3 [3] _____ 037 CODE 4 [3] _____ 038 CODE 5 [3] _____ 039 CODE 6 [3] _____ 040 EXITS TO PROGRAMMING ENTRY MODE
Zone Definitions {1-255}	041 ZONE 1 [64] _____ 042 ZONE 2 [72] _____ 043 ZONE 3 [81] _____ 044 ZONE 4 [65] _____ 045 ZONE 5 [65] _____ 046 ZONE 6 [65] _____ (Refer to the Zone Planning Guide)
Digital Communicator Setup	047 COMMUNICATOR DISABLE/DELAY IN SECONDS [0] _____ {0-255, 0 disables communicator} 048 DIAL ATTEMPTS BEFORE SHUTDOWN TELEPHONE NUMBER 1* [8] _____ {1-15} <i>Note: Odd value (1, 3, etc.) will disable the fail to communicate warning.</i> 049 DIAL ATTEMPTS BEFORE SHUTDOWN TELEPHONE NUMBER 2* [8] _____ {1-15} 050 DUAL REPORTING OF ALARMS [0] _____ {0=N 1=Y} 051 DUAL REPORTING OF NON-ALARMS [0] _____ {0=N 1=Y} * An even value (6 or 8) shall be selected to enable the Fail to Communicate. 052 COMMUNICATOR ON-HOOK TIME IN SECONDS [3] _____ {0-255} 053 TIME BETWEEN DIAL ATTEMPTS IN SECONDS [10] _____ {0-15} 054 ABORT COMMUNICATOR UPON DISARMING [0] _____ {0=N 1=Y} 055 DISABLE DIALER TEST ON POWER-UP [0] _____ {0=N 1=Y} 056 EXCEPTION OPENING/SYSTEM RESTORE [0] _____ {0=N 1=Y}
Account Number Telephone Number 1 (0-15)	057 DIGIT 1 [0] _____ (See note) 058 DIGIT 2 [8] _____ 059 DIGIT 3 [8] _____ 060 DIGIT 4 [8] _____ <i>Note: Digit 1 MUST ALWAYS be "0" unless 4/2 format is enabled (Function 63). A "0" signifies no entry. To report the number "0", a "10" must be programmed. TRANSPORT-PC and some receivers translate numbers 10,11,12,13,14,15 to hexadecimal characters A,B,C,D,E,F, respectively.</i>
Reporting Formats for Telephone Number 1 (0-15)	061 TRANSMISSION FORMAT [2] _____ {0-7} 065 EXTENDED SINGLE LINE [0] _____ {0=N 1=Y} 062 SINGLE ROUND REPORT [0] _____ {0=N 1=Y} 066 PARITY CHECKSUM [0] _____ {0=N 1=Y} 063 4/2 TRANSMISSION FORMAT [0] _____ {0=N 1=Y} 067 TOUCHTONE DIALING [0] _____ {0=N 1=Y} 064 EXTENDED STANDARD [0] _____ {0=N 1=Y}

Reporting Codes Telephone 1 (Range 0-15)	068 ZONE 1	[3] _____	076 KP PANIC "C"	[4] _____	084 LOW BATTERY	[0] _____
	069 ZONE 2	[3] _____	077 DURESS	[0] _____	085 BATTERY RESTORE	[0] _____
	070 ZONE 3	[3] _____	078 OPENING	[0] _____	086 AC FAILURE	[0] _____
	071 ZONE 4	[3] _____	079 CLOSING	[0] _____	087 AC RESTORE	[0] _____
	072 ZONE 5	[3] _____	080 SHUNTED ZONE	[0] _____	088 MEMORY ERROR	[0] _____
	073 ZONE 6	[3] _____	081 CANCEL	[0] _____	089 AUTO TEST	[0] _____
	074 KP PANIC "A"	[1] _____	082 ZONE RESTORE	[0] _____		
075 KP PANIC "B"	[2] _____	083 SUPERVISORY/TB	[0] _____			

Number To Dial Telephone 1 (0-15) Defaults are [15]	090 D1	091 D2	092 D3	093 D4	094 D5	095 D6	096 D7	097 D8
	098 D9	099 D10	100 D11	101 D12	102 D13	103 D14	104 D15	105 D16

NOTE: A 0 or 10 = dialing number "0", 11 and 12 = Touchtone "*" and "#", 13 = three second dialing pause, 14 = additional wait for dial tone, 15 = end of dialing and MUST be programmed after the last valid number.

Special Functions	106 AUDIO LISTEN-IN CAPABILITY TELEPHONE NUMBER 1 [0] _____ {0=N 1=Y}
	107 EXITS TO PROGRAMMING ENTRY MODE
	108 COPY TEL. 1 ACCOUNT, FORMAT AND REPORTING CODES TO TEL. 2 (no value required)
	109 COPY TEL 1, DIALED NUMBER TO TEL. 2 (no value required)

Account Number Telephone 2(0-15)	110 DIGIT 1 [0] _____ (See note)	111 DIGIT 2 [8] _____	112 DIGIT 3 [8] _____	113 DIGIT 4 [8] _____
----------------------------------	----------------------------------	-----------------------	-----------------------	-----------------------

Note: Digit 1 MUST ALWAYS be "0" unless 4/2 format is enabled (Function 114). A "0" signifies no entry. To report the number "0", a "10" must be programmed. TRANSPORT-PC and some receivers translate numbers 10,11,12,13,14,15 to hexadecimal characters A,B,C,D,E,F, respectively.

Reporting Formats Telephone 2	114 TRANSMISSION FORMAT	[0] _____ {0-7}	118 EXTENDED SINGLE LINE	[0] _____ {0=N 1=Y}
	115 SINGLE ROUND REPORT	[0] _____ {0=N 1=Y}	119 PARITY CHECKSUM	[0] _____ {0=N 1=Y}
	116 4/2 TRANSMISSION FORMAT	[0] _____ {0=N 1=Y}	120 TOUCHTONE DIALING	[0] _____ {0=N 1=Y}
	117 EXTENDED STANDARD	[0] _____ {0=N 1=Y}		

Reporting Codes Telephone 2 (Range 0-15)	121 ZONE 1	[3] _____	129 KP PANIC "C"	[4] _____	137 LOW BATTERY	[0] _____
	122 ZONE 2	[3] _____	130 DURESS	[0] _____	138 BATTERY RESTORE	[0] _____
	123 ZONE 3	[3] _____	131 OPENING	[0] _____	139 AC FAILURE	[0] _____
	124 ZONE 4	[3] _____	132 CLOSING	[0] _____	140 AC RESTORE	[0] _____
	125 ZONE 5	[3] _____	133 SHUNTED ZONE	[0] _____	141 MEMORY ERROR	[0] _____
	126 ZONE 6	[3] _____	134 CANCEL	[0] _____	142 AUTO TEST	[0] _____
	127 KP PANIC "A"	[1] _____	135 ZONE RESTORE	[0] _____		
	128 KP PANIC "B"	[2] _____	136 SUPERVISORY/TB	[0] _____		

Number To Dial Telephone 2(0-15) Defaults are [15]	143 D1	144 D2	145 D3	146 D4	147 D5	148 D6	149 D7	150 D8
	151 D9	152 D10	153 D11	154 D12	155 D13	156 D14	157 D15	158 D16

NOTE: Program these Functions in the same manner as Functions 090 - 105

Special Functions	159 AUDIO LISTEN-IN CAPABILITY TELEPHONE NUMBER 2 [0] _____ {0=N 1=Y}
	160 NUMBER OF RINGS UNTIL COMMUNICATOR AUTOMATICALLY ANSWERS [0] _____ {0-15}

Upload/Download Callback Phone Number To Dial (0-15) Defaults are [15]	161 D1	162 D2	163 D3	164 D4	165 D5	166 D6	167 D7	168 D8
	169 D9	170 D10	171 D11	172 D12	173 D13	174 D14	175 D15	176 D16

NOTE: Program these Functions in the same manner as Functions 090 - 105

Control Options All except #181 are Yes/No format (0=No, 1=Yes)	177 TWO DIGIT ARMING	[0] ____	185 KEYSWITCH MODE CHANGE	[0] ____
	178 ENABLE FORCE ARMING	[0] ____	186 SUPERVISORY/DAY ALERT LATCH	[0] ____
	179 PERMANENT FORCE ARMING (SHUNT)	[0] ____	187 AUTOMATIC INTERIOR OFF	[0] ____
	180 DELAY BURGLAR RESTORE UNTIL CUTOFF	[0] ____	188 EXTEND BA LOOP STABILIZATION	[0] ____
	181 BURGLAR ALARM REPORTS UNTIL LOCKOUT {0-15, 0=No communicator lockout}	[0] ____	189 DISABLE INTERIOR FOLLOWER	[0] ____
	182 PULSING BURGLAR ALARM OUTPUT	[0] ____	190 INTERIOR ON/OFF AVAIL. IF ARMED	[0] ____
	183 PULSING AUXILIARY "A"(FIRE ff) OUTPUT	[1] ____	191 DELAY OFF WHEN INTERIOR OFF	[0] ____
	184 BURGLAR LOOP AUDIBLE LOCKOUT	[0] ____	192 SIREN/BELL TEST UPON ARMING	[0] ____
			193 RESET TEST TIMER ON KISSOFF	[0] ____
			194 INTERIOR DEFAULT UPON DISARM	[0] ____
Control Station Options (0=No, 1=Yes)	195 DISABLE KEYPAD SHUNTING	[0] ____	199 DISABLE KEY 8 WALK TEST	[0] ____
	196 DISABLE KEY 4 INTERIOR ON/OFF	[0] ____	200 SILENT KEYPAD ON BURGLAR	[0] ____
	197 DISABLE KEY 6 CHIME ON/OFF	[0] ____	201 SILENT KEYPAD/NO LED BLINK ON AUX "B"	[0] ____
	198 DISABLE KEY 7 POWER INTERRUPT	[1] ____	202 START ENTRANCE DELAY 1 ON KP ENTRIES	[0] ____
Zone Supervisory	203 ZONE 1 [0] ____	205 ZONE 3 [0] ____	Trouble upon: (0=OPEN 1=SHORT)	207 ZONE 5 [0] ____
	204 ZONE 2 [0] ____	206 ZONE 4 [0] ____		208 ZONE 6 [0] ____
Extended Report Digits (0-15) For User Codes 1-6	209 CODE 1 [1] ____	212 CODE 4 [4] ____	215 EXTENDED KEYSWITCH ZONE REPORTING CODE [7] ____	
	210 CODE 2 [2] ____	213 CODE 5 [5] ____		
	211 CODE 3 [3] ____	214 CODE 6 [6] ____		
Zone Alarms	216 ZONE 1 [1] ____	218 ZONE 3 [3] ____	220 ZONE 5 [5] ____	
	217 ZONE 2 [2] ____	219 ZONE 4 [4] ____	221 ZONE 6 [6] ____	
Zone Restorals	222 ZONE 1 [1] ____	224 ZONE 3 [3] ____	226 ZONE 5 [5] ____	
	223 ZONE 2 [2] ____	225 ZONE 4 [4] ____	227 ZONE 6 [6] ____	
Zone Shunts	228 ZONE 1 [1] ____	230 ZONE 3 [3] ____	232 ZONE 5 [5] ____	
	229 ZONE 2 [2] ____	231 ZONE 4 [4] ____	233 ZONE 6 [6] ____	
Zone Supervisory/ Troubles	234 ZONE 1 [1] ____	236 ZONE 3 [3] ____	238 ZONE 5 [5] ____	
	235 ZONE 2 [2] ____	237 ZONE 4 [4] ____	239 ZONE 6 [6] ____	
Misc. Extended Reporting Digits	240 EXTENDED AC CODE	[10] ____	244 EXTENDED KEYPAD PANIC "A" CODE	[9] ____
	241 EXTENDED BATTERY CODE	[9] ____	245 EXTENDED KEYPAD PANIC "B" CODE	[9] ____
	242 EXTENDED MEMORY ERROR CODE	[15] ____	246 EXTENDED KEYPAD PANIC "C" CODE	[9] ____
	243 EXTENDED TEST CODE	[9] ____	247 EXTENDED MISSING KEYPAD CODE	[15] ____
Special Purpose All are Yes/No format except #251, #252, #255, #256 & #264-269 (0=No, 1=Yes)	248 ELIMINATE BURG ZONE EOLR SUPERVISION	[0] ____		
	249 EXITS TO PROGRAMMING ENTRY MODE			
	250 RESTORE USER CODE 1 DEFAULT VALUE ____ (NO VALUE REQUIRED)			
	251 FAST LOOP RESPONSE TIME [2] ____ (0-15)			
	252 SLOW LOOP RESPONSE TIME [6] ____ (0-15)			
	253 EXITS TO PROGRAMMING ENTRY MODE			
	254 RESTORE FACTORY DEFAULTS [0] ____ (0-1)			
	255 INSTALLER PROGRAM AUTHORIZATION CODE _____ [96321]			
	256 ASSIGNABLE OUTPUT (TERM.3) DEFINITION [0] ____ (0-4)			
	257 BURGLAR ALARM ACTIVATES ASSIGNABLE OUTPUT (TERM.3) [1] ____ (0-1)			
	258 AUX "A"(FIRE ff) ALARM ACTIVATES ASSIGNABLE OUTPUT (TERM.3) [1] ____ (0-1)			
	259 AUX "B"(POLICE) ALARM ACTIVATES ASSIGNABLE OUTPUT (TERM.3) [1] ____ (0-1)			
	260 AUX "C"(EMERGENCY) ALARM ACTIVATES ASSIGNABLE OUTPUT (TERM.3) [1] ____ (0-1)			
	261 DISABLE KEYPAD PANIC AUX "A" (FIRE ff) [0] ____ (0-1)			
	262 DISABLE KEYPAD PANIC AUX "B" (POLICE) [0] ____ (0-1)			
	263 DISABLE KEYPAD PANIC AUX "C" (EMERG.) [0] ____ (0-1)			
	264-266 FACTORY USE - NOT PROGRAMMABLE (264 EXITS TO PROGRAMMING ENTRY MODE)			
	267 TELEPHONE NUMBER 1 UPLOAD/DOWNLOAD COMPLETED REPORTING CODE [9] ____ (0-15)			
	268 TELEPHONE NUMBER 2 UPLOAD/DOWNLOAD COMPLETED REPORTING CODE [9] ____ (0-15)			
	269 EXTENDED UPLOAD/DOWNLOAD COMPLETED REPORTING CODE [9] ____ (0-15)			
	270 DIAL TONE DETECTION/1 ALARM PER ZONE UNTIL DISARM [0] ____ (0-15)			
	271 KEYPAD PANIC 3 SECOND (HOLD OR PRESS TWICE) MODE [1] ____ (0-1) (0 = INSTANT 1 = 3 SECOND MODE)			
	272 ANSWER MACHINE BYPASS 2ND CALL TIME LIMIT (10 SEC INCREMENTS) [0] ____ (0-15)			
273 LISTEN-IN TIME [1] ____ (1-15)				

0=80ms, 1=40ms, 2=80ms, 3=120ms, 4=160ms, 5=200ms, 6=320ms, 7=480ms,
8=600ms, 9=800ms, 10=1sec, 11=2sec, 12=4sec, 13=6sec, 14=8sec, 15=10sec

Zone Planning Guide

ZONE TYPE	DEFINITION	VALUE	ZONES					
			01	02	03	04	05	06
BURGLAR LOOPS	ENTRY DELAY 1	= 0						
	INSTANT	= 1						
	SILENT INSTANT	= 7						
	ENTRY DELAY 2	= 8						
	INTERIOR	= 16						
	NON-SHUNTABLE	= 32						
	SLOW RESPONSE	= 64						
	SUPERVISORY/TBL	=128						
AUXILIARY "A" (ff FIRE)		= 2						
	SHUNTABLE	= 32						
	SLOW RESPONSE	= 64						
AUXILIARY "B" (POLICE)		= 3						
	NO AUX. "B" ALARM OUTPUT	= 8						
	NO VIOLATION OUTPUT ON Z729	= 16						
	SHUNTABLE	= 32						
	SLOW RESPONSE	= 64						
	SUPERVISORY/TBL	= 128						
AUXILIARY "C" (EMERGENCY)		= 4						
	SHUNTABLE	= 32						
	SLOW RESPONSE	= 64						
	SUPERVISORY/TBL	= 128						
KEYSWITCH		= 5						
	MAINTAINED TYPE	= 16						
	SHUNTABLE	= 32						
	SUPERVISORY/TBL	= 128						
COMMUNICATOR REPORT ONLY		= 6						
	SHUNTABLE	= 32						
	SLOW RESPONSE	= 64						
	SUPERVISORY/TBL	= 128						
TOTAL VALUE FOR SELECTED ZONE TYPE =								
FUNCTION # FOR ENTERING VALUE TOTAL			41	42	43	44	45	46

ZONE	PROTECTION
1 =	
2 =	
3 =	
4 =	
5 =	
6 =	
KEYPAD PANIC ZONE "A" = _____	
KEYPAD PANIC ZONE "B" = _____	
KEYPAD PANIC ZONE "C" = _____	

SPECIAL FUNCTIONS
ASSIGNABLE OUTPUT (terminal 3) Activates upon: <ul style="list-style-type: none"> <input type="checkbox"/> ALARMS <ul style="list-style-type: none"> <input type="checkbox"/> Burglar Alarms <input type="checkbox"/> Aux. "A" Alarms <input type="checkbox"/> Aux. "B" Alarms <input type="checkbox"/> Aux. "C" Alarms <li style="text-align: center; padding: 5px 0;">or <input type="checkbox"/> NON-ALARMS (one only) <ul style="list-style-type: none"> <input type="checkbox"/> Key 7 Sw. Power Reset/Auto Tests <input type="checkbox"/> Access Activation <input type="checkbox"/> Supervisory/Trouble conditions <input type="checkbox"/> Entrance Pre-alarms and Chime

DATE:	
INSTALLED BY:	

PROGRAM FUNCTION DESCRIPTIONS

Each programming Function is assigned a number from 1 to 271. These correspond directly to the numbers listed on the Program Function Map. A description of each function is provided in this section. Select those that are to be programmed, and write the values to be programmed onto the Program Function map. The pre-programmed (factory default) values are indicated in brackets [] on the Function map. If a Function is to be left at its default value, no programming will be required.

NOTE: Functions 1-6 may ONLY be accessed through user level programming. Functions 34 - 271 can ONLY be accessed through installer level programming. Functions 7 - 33 may be accessed from either user or installer level programming.

1 - MASTER USER AUTHORIZATION CODE

This is a dual purpose code. It may be used for arming/disarming and other day to day operation as determined by the assigned Configuration Digit, programmed through installer level (Function 34). It also functions as a programming authorization code to provide access to the user level of programming. This code is 1245 at factory default and may be changed at any time through user level programming. This code MUST be four digits in length. Digits may repeat within the code. This function is NOT accessible through installer level programming.

WARNING: Do not program a user code with the same digits as the first four digits of the Installer Program Authorization Code. This will cause the Installer Program Authorization Code to become inoperable.

2-6 - USER AUTHORIZATION CODES 2 - 6

User authorization codes are used to arm/disarm the control and provide other day to day operations as determined by the assigned Configuration Digit (Function 34-39). Each code MUST be four digits in length. Digits may repeat anywhere within the code. User codes 2-6 may only be programmed through user level programming. **SEE WARNING NOTE ABOVE.**

7 - USAGE COUNT CODE 6

User authorization code 6 performs the same function as user codes 2 - 5 except that the number of times that it can be used is controlled by Function 7. After the usage count expires, the code becomes inactive until a new usage count value is programmed into Function 7. Code 6 may also be programmed to be permanently active by selecting a value of 255 for Function 7.

8 - TIME UNTIL THE NEXT COMMUNICATOR TEST REPORT

This Function is used to select the time until the next automatic communicator test is reported to the central station. A report code must be programmed (Functions 89 & 142) in order for the communicator test to occur. The test report, if enabled, will be reported after the selected time expires and then routinely every 12 hours, or 1 to 7 days as specified by Function 20.

9 - CLEAR ALARM MEMORY

Entering this location will automatically clear the alarm memory. No value is required nor may be programmed in this location. If this location is entered through the Installer level, the " * " (STORE) key must be pressed to accept the entry.

10 - DELETE CODES

Entering this location followed by pressing the numeric keys (1 to 6) corresponding to a user authorization code, deletes the corresponding user code. Entering " 0 " deletes the installer program code (Function 255).

11 - ENTRANCE DELAY #1 TIME

Allowable time in seconds for entering through an "entry delay 1" defined zone and disarming the system without causing an alarm condition. Valid range is 1 to 255 seconds. An odd value will disable the control station prealarm sounder. Default is 30.

12 - ENTRANCE DELAY #2 TIME

Allowable time in seconds for entering through an "entry delay 2" defined zone and disarming the system without causing an alarm condition. Valid range is 1 to 255 seconds. An odd value will disable the control station prealarm sounder. Default is 46.

Z900 Specifications & Instructions

13 - EXIT DELAY TIME

Allowable time in seconds for exiting through a delay or interior defined zone without causing an alarm. Valid range is 1-255 seconds. An odd value will disable the control station prealarm sounder. Default is 60.

14 - ACCESS ON TIME

Amount of time that the Access output will be active when an Access code is entered. In order for the control to provide access output, the Assignable Output must be programmed to produce +12 VDC upon Access activation (Function 256) or the Z729 Siren Driver/Output Expander must be used. Valid range for Function 14 is 1 to 255 seconds. Default is 5. A value of "0" will allow the access to switch on/off each time the code is entered.

15 - DELAY BURGLAR ALARM OUTPUT

Time in seconds that may be programmed to delay Burglar alarm output. Outputs may be obtained from the optional Z729 Siren Driver/Output Expander and the Assignable Output (terminal 3). Valid range is 0 to 255 seconds. Default is 0 seconds.

16 - BURGLAR ALARM CUTOFF TIME

Time in minutes that the Burglar alarm output will be active before automatic cutoff. Burglar alarm outputs may be obtained through the optional Z729 Siren Driver/Output Expander and the Assignable Output (if programmed). Valid range is 0 to 255 minutes. A value of "0" or "255" eliminates automatic cut-off. Default is 10 minutes.

17 - AUXILIARY "A" (FIRE ff) CUT-OFF TIME

Time in minutes that the Auxiliary "A" (Fire ff) alarm output will be active before automatic cutoff. Auxiliary "A" alarm outputs may be obtained through the optional Z729 Siren Driver/Output Expander and the Assignable Output (if programmed). Valid range is 0 to 255 minutes. A value of "0" or "255" eliminates automatic cut-off. Default is 255 (no cut-off).

18 - AUXILIARY "B" (POLICE) CUTOFF TIME

Time in minutes that the Auxiliary "B" (Police) alarm output will be active before automatic cutoff. Auxiliary "B" alarm outputs may be obtained through the optional Z729 Siren Driver/Output Expander and the Assignable Output (if programmed). Valid range is 0 to 255 minutes. A value of "0" or "255" eliminates automatic cut-off. Default is 10 minutes.

19 - AUXILIARY "C" (EMERGENCY) CUTOFF TIME

Time in minutes that the Auxiliary "C" (Emergency) alarm outputs will be active before automatic cutoff. Auxiliary "C" alarm outputs may be obtained through the optional Z729 Siren Driver/Output Expander and the Assignable Output (if programmed). Valid range is 0 to 255 minutes. A value of "0" or "255" eliminates automatic cut-off. Default is 10 minutes.

20 - TIME BETWEEN COMMUNICATOR TESTS

This Function specifies the time between each automatic communicator test report. This report may be programmed for every 12 hours or from 1 to 7 days. A value of "0" represents 12 hours and values of "1-7" represent days.

21-32 - RESERVED FOR FUTURE USE (EXITS TO PROGRAMMING ENTRY MODE)

Entry into these locations will command the system to return to the point where programming mode was initially entered with all LEDs flashing.

33 - UPLOAD DATA TO A REMOTE LOCATION

This Function is used to perform a complete EEPROM memory upload to a remote location IBM PC® or compatible computer over ordinary telephone lines. This function requires the installation of a computer with special software to receive the data. Telephone contact must be made before Function 33 is activated. When this function is activated, the telephone line is seized and the data is uploaded. Transmission of data can be interrupted by depressing the "*" key for five seconds or until the system releases the telephone line. See "Remote Programming" on page 23 for details.

INSTALLER LEVEL PROGRAMMING ONLY BEYOND THIS POINT

34 - 39 - CONFIGURATION DIGITS FOR CODES 1 - 6

Each user authorization code is assigned a security level called a "Configuration Digit" (programming Function 34 through 39) which defines the operations that the code is authorized to perform. Select the appropriate configuration digit for each code desired and enter the values into the function map. Table 6 describes the configuration digits and describes the usage allowed by each.

DIGIT	DESCRIPTION
1	User code will Arm and Disarm the control.
2	User code will activate access output. †
3	User code will Arm/Disarm the control. "0" (held 3 seconds) followed by user code will activate the access output. †
4	High Security Arm/Disarm. When the control is armed by a High Security code, only that code or another High Security code can disarm the control.
5	User code will Arm and Disarm the control and activate access output simultaneously. †
6	Special Arm/Disarm. Same as configuration digit 1 with one exception. If the communicator is programmed for opening/closing reports, no report will transmit when this code is used to arm or disarm the control. Warning: If the control is armed by another code and a closing report is sent, the central station WILL NOT receive an opening if the control is later disarmed by a code which has a configuration digit "6".
7	User code will Arm and Disarm the control and activate access output simultaneously. Pressing "0" and holding for three seconds followed by the entry of a valid user code will activate access independently. †
8	NOT USED
9	User code will Arm and Disarm the control and transmit the duress code to central station receiver simultaneously.

TABLE 6 CONFIGURATION DIGITS

40 - FOR FUTURE USE - EXITS TO PROGRAMMING ENTRY MODE (SEE FUNCTION 21)

41 - 46 - ZONE 1-6 DEFINITION

These locations are used to define the 6 hardwired zones. Refer to the Zone Planning Guide (page D) and select the desired zone types by entering values of selected zone options and sub-options into the spaces provided. Add the values assigned to each zone and enter the totals for each zone into the respective Functions 41 - 46.

47 - COMMUNICATOR DISABLE AND DELAY

This function is used to activate or deactivate the communicator. If a value of "0" is entered the communicator will remain inactive. Any value of 1 to 255 will allow the communicator to enable after a delay of the same number in seconds.

48 - DIAL ATTEMPTS BEFORE SHUTDOWN (TELEPHONE NUMBER 1)

This Function sets the number of times that the communicator will attempt to dial the central station receiver using telephone number 1 before automatically shutting down if unsuccessful. Valid range is 1-15. **DO NOT PROGRAM WITH A VALUE OF "0"**. If the communicator is unsuccessful, the control stations will begin beeping and the "Trouble" LED will light to indicate a "Failure to Communicate" condition. Pressing the "*" key will silence the control station sounder. The "Trouble" LED will remain lighted until the communicator successfully establishes contact with the central station receiver and receives a handshake. The "Trouble" LED can also be reset by entering the program mode. The fail to communicate warning may be totally disabled for either telephone numbers by programming an odd value (1,3, etc.) for the dial attempts. An even value (6, 8, etc.) shall be selected to enable the Fail to Communicate.

† NOTE: The Access output may be provided from the optional Z729 Siren Driver/Output Expander or through the Assignable Output (If programmed). See page 10 and 11.

Z900 Specifications & Instructions

49 - DIAL ATTEMPTS BEFORE SHUTDOWN (TELEPHONE NUMBER 2)

This function sets the number of times that the communicator will attempt to dial the central station receiver using telephone number 2 before automatically shutting down if unsuccessful. Valid range is 1-15. See Function 48 for additional information. **An even value (2, 4, etc.) shall be selected to enable the Fail to Communicate. DO NOT PROGRAM WITH A VALUE OF "0".**

50 - DUAL REPORT OF ALARMS

Enabling this feature permits reporting of selected alarm conditions to two central stations. For example, if Keypad Panic conditions are desired to be reported to two central stations, reporting codes for both "Keypad Panic/ Telephone Number 1" (Function 74) and "Keypad Panic/ Telephone Number 2" (Function 127) must be programmed, and a value of "1" must be programmed in Function 50 to enable Dual Reporting. If this option is not selected, the communicator will use telephone number 2 only as a back-up if communication through telephone number 1 was unsuccessful. A value of "1" in Function 50 instructs the communicator to report all alarm conditions (that are programmed to report) to the central station by dialing each telephone number. All Zone 1-6 alarms, Keypad Panic, Duress, Cancel, Zone Restore, and Supervisory/Trouble conditions are considered "Alarm" conditions.

51 - DUAL REPORT OF NON-ALARMS

Enabling this feature permits reporting of selected non- alarm conditions to two central stations. For example, if low battery conditions are desired to be reported to two central stations, reporting codes for both "Low Battery/ Telephone Number 1" (Function 84) and "Low Battery/ Telephone Number 2" (Function 137) must be programmed, and a value of "1" must be programmed in Function 51 to enable Dual Reporting. If this option is not selected, the communicator will use telephone number 2 only as a back-up if communication through telephone number 1 was unsuccessful. A value of "1" in Function 51 instructs the communicator to report all non-alarm conditions (that are programmed to report) to the central station by dialing each telephone number. Non-alarm conditions include Opening, Closing, Shunted Zone, Low Battery, Battery Restore, AC Failure, AC Restore, Memory Error, and Automatic Test conditions.

52 - COMMUNICATOR ON-HOOK TIME

Time in seconds that the communicator will place the telephone line on-hook if no dial tone is detected. The line seizure relay remains closed during this period. Valid range is 1-15.

53 - TIME BETWEEN DIAL ATTEMPTS

Time in seconds between dial attempts if previous dial attempt was unsuccessful. The telephone line seizure relay releases the line during this time. Valid range is 1-255.

54 - ABORT COMMUNICATOR UPON DISARMING

A value of "1" in this location will allow the communicator transmission to be aborted upon entry of the arm/disarm code. A cancel report code can be sent upon abort by programming Function 81 and 134.

55 - DISABLE DIALER TEST ON POWER-UP

If a test report code (Function 89 and 142) is programmed, a value of "0" allows the communicator to dial the central station with a test report code whenever the system is powered-up or reset by the watchdog timer. A value of "1" disables this feature preventing a dialer test on power-up.

56 - EXCEPTION OPENING/SYSTEM RESTORE

A value of "1" causes the communicator to report the opening code (Function 78 and 131) ONLY when the system has been disarmed (reset) after an alarm. A value of "0" disables Exception Opening/Restore reporting.

57-60 - ACCOUNT NUMBER (TELEPHONE NUMBER 1)

Functions 57 to 60 store the 3 or 4 digit account number. Each digit of the account number is stored in a separate function beginning with function 57=digit 1, 58=digit 2, 59=digit 3, and 60=digit 4. Valid range is 0-15. A zero "0" signifies NO digit and must be programmed into Function 57 if only a three digit account number is desired. A 10 must be programmed to represent the number 0. Note: TRANSPORT-PC and some receivers interpret the numbers 10, 11, 12, 13, 14, and 15 as hexadecimal characters A, B, C, D, E, and F respectively.

61 - TRANSMISSION FORMAT (TELEPHONE NUMBER 1)

Enter a value of "0" to "7" to select the communicator transmission format for telephone number 1. Refer to Table 7 on the next page.

0 = Autobaud. Format 1 or 2 automatically selected based upon the handshake tone from the receiver.
1 = 1400 Hz. handshake, 1900 Hz. data, 10 baud. (Ademco, Adcor, FBI, Osborne Hoffman, Radionics, Silent Knight, Varitech, and Vertex, slow format).
2 = 2300 Hz. handshake, 1800 Hz. data, 20 baud. (DCI, FBI, Franklin, Osborne Hoffman, Sescoa, Varitech, and Vertex, fast format).
3 = 1400 Hz. or 2300 Hz. handshake, 1800 Hz. data, 40 baud. (Radionics superfast no parity).
4 = 1400 Hz. handshake, 1900 Hz. data, 15 baud. (Silent Knight fast format).
5 = Radionics BFSK ® (1400 Hz. or 2300 Hz. handshake). (FBI, Radionics, and Varitech).
6 = Sescoa Model 3000, slow format.
7 = Sescoa Model 3000, fast format.

TABLE 7 COMMUNICATOR TRANSMISSION FORMATS

62 - SINGLE ROUND REPORTING (TELEPHONE NUMBER 1)

Some older central station receivers can only receive one report per telephone call. A value of "1" instructs the communicator to hang up after each single report and redial the central station for each additional report. **NOTE: Extended reports cannot be used with single round reporting.**

63 - 4/2 EXTENDED TRANSMISSION FORMAT (TELEPHONE NUMBER 1) †

A value of "1" enables 4/2 Transmission format. This is a form of extended reporting whereby the account code, consisting of four digits, is transmitted followed by 2 additional digits. The first of these 2 additional digits represents the report code and the second represents the extended code.

64 - STANDARD 2 LINE EXTENDED REPORTING (TELEPHONE NUMBER 1) †

A value of "1" enables standard 2 line extended transmission format. In this reporting format, the central station will receive its report on two printed lines. The example below details a burglar report from zone 4 of customer account number 268. Zone 4 was programmed to report a code 3 "Burglary".

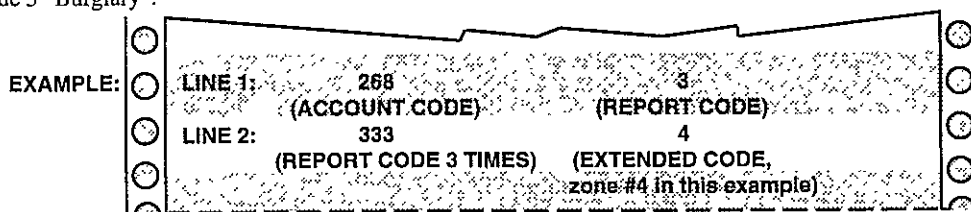

The central station will identify this as: Account 268, report code 3 (burglary) from zone 4.

FIGURE 16 2 LINE EXTENDED REPORTING EXAMPLE

65 - SINGLE LINE EXTENDED (RADIONICS A+) REPORTING (TELEPHONE NUMBER 1) †

This format is similar to standard extended format with the exception that report codes from 1 to 10 are not extended, while all codes from 11 ("B" hex.) thru 15 ("F" hex.) are. When transmitting to a Radionics or compatible receiver, the full report will be received and printed on a single line. In order for alarms, restores, etc. to be transmitted properly with this format, each zone report code must be programmed with the corresponding zone number respectively. When sending to Radionics type receivers, the following values will be printed as: 11 = OPENING, 12 = CLOSING, 13 = CANCEL(ABORT), 14 = RESTORAL, and 15 = TROUBLE.

- * When programming for Radionics Superfast (3) format, EITHER Extended Standard or Single Line Extended (Radionics A+) may be programmed but NEVER BOTH.
- ** When programming for Radionics BFSK (5) format, one CANNOT select Extended Standard, Single Line Extended (Radionics A+) or Parity Checksum (Radionics). The value of these functions must be programmed as "0".

66 - PARITY CHECKSUM (RADIONICS) (TELEPHONE NUMBER 1)

This function commands the communicator to transmit only one line of data containing the account and report code followed by a parity checksum digit for verification rather than sending each line of data twice. The system calculates the parity digit automatically by summing the total of the account and report codes. This feature is most commonly used when transmitting to Radionics receivers and transmission speed is generally faster and telephone connect time is reduced. A value of "1" enables this feature.

† NOTE: Functions 63, 64, and 65 are mutually exclusive. Choose one only.

2900 Specifications & Instructions

67 - TOUCHTONE ® DIALING (TELEPHONE NUMBER 1)

A value of "1" enables the communicator to dial using touchtone ®. A value of "0" enables rotary (pulse) dialing.

68-73 - ZONES 1 - 6 REPORTING CODES (TELEPHONE NUMBER 1)

Value programmed in each location represents the code that the corresponding hardwire zone will report to the central station receiver (Function 68 corresponds to zone 1, 69 to zone 2 etc.). Valid range is 0-15. A value of 0 disables reporting of the assigned zone.

NOTE: A reporting code of "0" is possible by entering a value of "10". TRANSPORT-PC and some receivers interpret values of "10" through "15" as hexadecimal codes "A" through "F".

74 - KEYPAD PANIC "A" (TELEPHONE NUMBER 1)

Code reported when the control station panic zone "A" is activated. Valid range is 0-15. A value of "0" disables reporting.

75 - KEYPAD PANIC "B" (TELEPHONE NUMBER 1)

Code reported when the control station panic zone "B" is activated. Valid range is 0-15. A value of "0" disables reporting.

76 - KEYPAD PANIC "C" (TELEPHONE NUMBER 1)

Code reported when the control station panic zone "C" is activated. Valid range is 0-15. A value of "0" disables reporting.

77 - DURESS REPORTING CODE (TELEPHONE NUMBER 1)

Code reported when a duress arm/disarm code is entered at the keypad. The extended reporting code which identifies the user is programmed in Functions 209 - 214. Valid range is 0-15. A value of "0" disables reporting.

78 - OPENING REPORT CODE (TELEPHONE NUMBER 1)

Code reported upon disarming the control. For exception opening see Function 56. The extended reporting code which identifies the user is programmed in Functions 209-214. Valid range is 0-15. A value of "0" disables reporting.

79 - CLOSING REPORT CODE WITH RINGBACK (TELEPHONE NUMBER 1)

Code reported upon arming the control. The extended reporting code which identifies the user is programmed in Functions 209-214. If this feature is selected, the control stations will beep six times followed by a two second error tone after a kiss-off tone has been received from the central station receiver. Exit delay will then be restarted. Valid range is 0-15. A value of "0" disables reporting.

NOTE: When arming or disarming using a key switch zone, the system will report the opening or closing code followed by the extended code as programmed in Function 215 to identify that the keyswitch was used.

80 - SHUNT REPORTING CODE (TELEPHONE NUMBER 1)

Common code reported whenever the control is armed with a shunted zone. The extended reporting code which identifies the zone is programmed in Functions 228-233. Valid range is 0-15. A value of "0" disables reporting.

81 - CANCEL REPORTING CODE (TELEPHONE NUMBER 1)

Code reported when an alarm transmission is aborted. The extended reporting code which identifies the user is programmed in Functions 209-214. Valid range is 0-15. A value of "0" disables reporting.

82 - ZONE RESTORE REPORTING CODE (TELEPHONE NUMBER 1)

Code reported when a zone which caused the alarm is restored to operation. The extended reporting code which identifies the zone is programmed in Functions 222-227. Valid range is 0-15. A value of "0" disables reporting.

83 - SUPERVISORY REPORTING CODE (TELEPHONE NUMBER 1)

Code reported when a zone programmed for supervisory is activated. The extended reporting code which identifies the zone is programmed in Functions 234-239. Valid range is 0-15. A value of "0" disables reporting.

84 - LOW BATTERY/FUSE BLOWN REPORTING CODE (TELEPHONE NUMBER 1)

Code reported when a low battery (while AC is not present) or blown fuse is detected. The extended reporting code is programmed in Function 241. Valid range is 0-15. A value of "0" disables reporting.

85 - BATTERY/FUSE RESTORE REPORTING CODE (TELEPHONE NUMBER 1)

Code reported after the restoral of a low battery condition or blown fuse. The code is reported after adequate system power is detected (above 11.2 volts) during the 24 hour automatic test or after manually pressing the 7 key. The extended reporting code is programmed through Function 241. Valid range is 0-15. A value of "0" disables reporting.

86 - AC FAILURE REPORTING CODE (TELEPHONE NUMBER 1)

Code reported when AC power is interrupted for more than approximately 5 minutes. The extended reporting code is programmed through Function 240. Valid range is 0-15. A value of "0" disables reporting.

87 - AC RESTORE REPORTING CODE (TELEPHONE NUMBER 1)

Code reported when AC power is restored. The extended code is programmed in Function 240. Valid range is 0-15. A value of "0" disables reporting.

88 - EEPROM MEMORY ERROR REPORTING CODE (TELEPHONE NUMBER 1)

Code reported when an EEPROM memory error is detected. The extended reporting code is programmed in Function 242. Valid range is 0-15. A value of "0" disables reporting.

89 - COMMUNICATOR TEST REPORTING CODE (TELEPHONE NUMBER 1)

Code reported when the communicator performs a test. Time between tests is set in Function 20. The extended reporting code is programmed in Function 243. Valid range is 0-15. A value of "0" disables reporting.

90-105 - TELEPHONE NUMBER 1

Enter the number to be dialed for telephone number 1 in Functions 90 through 105. Valid range is 0-15. A value of "0" or 10 represents dialing digit "0". A value of "11" represents "*" and 12 represents "#", when using Touchtone® dialing. A value of "13" instructs the communicator to pause for three seconds before dialing the next digit. A value of "14" instructs the communicator to wait 10 seconds for a second dial tone. A value of 15 must be programmed in the location following the last dialing digit to signify end of dialing.

106 - AUDIO LISTEN-IN CAPABILITY (TELEPHONE NUMBER 1)

The monitoring central station can receive One (1) minute of audio listen-in immediately following a transmission from the Digital Communicator and the subsequent receiver "kissoff" by connecting an amplified/filtered microphone to the listen-in post (see Figure 17, page 41) on the control board and then programming a value of "1" into this Function. In some cases, the microphone board must also be triggered. (Consult technical services department for more information).

Note: Listen-in will only occur when telephone #1 calls the central station unless Function 159 (audio listen-in telephone #2) is also programmed with a "1". This can be a useful feature to "SPLIT" the operation of listen-in to a separate receiver.

107 - RESERVED FOR FUTURE USE - EXITS TO PROGRAMMING ENTRY MODE (SEE FUNCTION 21)

108 - COPY TELEPHONE NUMBER 1 ACCOUNT, FORMATS, AND REPORT CODES TO TELEPHONE NUMBER 2

Entry into this location will command the system to copy all of the values in Functions 57-66 and 68-87 and duplicate them into Functions 110-119 and 121-126. **No values may be programmed into this location.**

109 - COPY TELEPHONE NUMBER 1 TO TELEPHONE NUMBER 2

Entry into this location will command the system to copy all of the values in Functions 90-105 and enter them into Functions 143-158. **No values may be programmed into this location.**

110-113 - ACCOUNT NUMBER (TELEPHONE NUMBER 2)

Functions 110 to 113 store the 3 or 4 digit account code. Valid range is 0-15. Please refer to Functions 57-60 for additional important information.

114 - TRANSMISSION FORMAT (TELEPHONE NUMBER 2)

Program the value in the same manner as Function 61.

115 - SINGLE ROUND REPORTING (TELEPHONE NUMBER 2)

Program the value in the same manner as Function 62.

Z900 Specifications & Instructions

116 - 4/2 TRANSMISSION FORMAT (TELEPHONE NUMBER 2)

Program the value in the same manner as Function 63.

117 - STANDARD 2 LINE EXTENDED REPORTING (TELEPHONE NUMBER 2)

Program the value in the same manner as Function 64.

118 - SINGLE LINE EXTENDED (RADIONICS A+) REPORTING (TELEPHONE NUMBER 2)

Program the value in the same manner as Function 65.

119 - PARITY CHECKSUM (RADIONICS) (TELEPHONE NUMBER 2)

Program the value in the same manner as Function 66.

120 - TOUCHTONE ® DIALING (TELEPHONE NUMBER 2)

A value of "1" enables the communicator to dial using touchtone ®. A value of "0" enables rotary (pulse) dialing.

121-126 - ZONES 1-6 REPORTING CODES (TELEPHONE NUMBER 2)

Value programmed in each location represents the codes that the corresponding hardware zone will report to the central station receiver (Function 121 corresponds to zone 1, 122 to zone 2 etc.). Determine program values in the same manner as locations 68 -73 . Valid range is 0-15. A value of "0" for any selected location disables its reporting.

127 - KEYPAD PANIC "A" (TELEPHONE NUMBER 2)

Code reported when the control station panic zone "A" is activated. Valid range is 0-15. A value of "0" disables reporting.

128 - KEYPAD PANIC "B" (TELEPHONE NUMBER 2)

Code reported when the control station panic zone "B" is activated. Valid range is 0-15. A value of "0" disables reporting.

129 - KEYPAD PANIC "C" (TELEPHONE NUMBER 2)

Code reported when the control station panic zone "C" is activated. Valid range is 0-15. A value of "0" disables reporting.

130 - DURESS REPORTING CODE (TELEPHONE NUMBER 2)

Code reported when a duress arm/disarm code is entered at the keypad. The extended reporting code which identifies the user is programmed in Functions 209 - 214. Valid range is 0-15. A value of "0" disables reporting.

131 - OPENING REPORT CODE (TELEPHONE NUMBER 2)

Code reported upon disarming the control. For exception opening see Function 56. The extended reporting code which identifies the user is programmed in Functions 209-214. Valid range is 0-15. A value of "0" disables reporting.

132 - CLOSING REPORT CODE WITH RINGBACK (TELEPHONE NUMBER 2)

Code reported upon arming the control. The extended reporting code which identifies the user is programmed in Functions 209-214. If this feature is selected, the control stations will beep six times followed by a two second error tone after a kiss-off tone has been received from the central station receiver. Exit delay will then be restarted. Valid range is 0-15. A value of "0" disables reporting.

NOTE: When arming or disarming using a key switch zone, the system will report the opening or closing code followed by the extended code as programmed in Function 215 to identify that the key switch was used.

133 - SHUNT REPORTING CODE (TELEPHONE NUMBER 2)

Common code reported whenever the control is armed with a shunted zone. The extended reporting code which identifies the zone is programmed in Functions 228-233. Valid range is 0-15. A value of "0" disables reporting.

134 - CANCEL REPORTING CODE (TELEPHONE NUMBER 2)

Code reported when an alarm transmission is aborted. The extended reporting code which identifies the user is programmed in Functions 209-214. Valid range is 0-15. A value of "0" disables reporting.

135 - ZONE RESTORE REPORTING CODE (TELEPHONE NUMBER 2)

Code reported when a zone which caused the alarm is restored to operation. The extended reporting code which identifies the zone is programmed in Functions 222-227. Valid range is 0-15. A value of "0" disables reporting.

136 - SUPERVISORY REPORTING CODE (TELEPHONE NUMBER 2)

Code reported when a zone programmed for supervisory is activated. The extended reporting code which identifies the zone is programmed in Functions 234-239. Valid range is 0-15. A value of "0" disables reporting.

137 - LOW BATTERY/FUSE BLOWN REPORTING CODE (TELEPHONE NUMBER 2)

Code reported when a low battery or blown fuse is detected. The extended reporting code is programmed in Function 241. Valid range is 0-15. A value of "0" disables reporting.

138 - BATTERY/FUSE RESTORE REPORTING CODE (TELEPHONE NUMBER 2)

Code reported after the restoral of a low battery condition or blown fuse. The code is reported after adequate system power is detected (above 11.2 volts) during the 24 hour automatic test or after manually pressing the 7 key. The extended reporting code is programmed through Function 241. Valid range is 0-15. A value of "0" disables reporting.

139 - AC FAILURE REPORTING CODE (TELEPHONE NUMBER 2)

Code reported when AC power is interrupted for more than approximately 5 minutes. The extended reporting code is programmed through Function 240. Valid range is 0-15. A value of "0" disables reporting.

140 - AC RESTORE REPORTING CODE (TELEPHONE NUMBER 2)

Code reported when AC power is restored. The extended code is programmed in Function 240. Valid range is 0-15. A value of "0" disables reporting.

141 - EEPROM MEMORY ERROR REPORTING CODE (TELEPHONE NUMBER 2)

Code reported when an EEPROM memory error is detected. The extended reporting code is programmed in Function 242. Valid range is 0-15. A value of "0" disables reporting.

142 - COMMUNICATOR TEST REPORTING CODE (TELEPHONE NUMBER 2)

Code reported when communicator performs a test. Time between tests is set in Function 20. The extended reporting code is programmed in Function 243. Valid range is 0-15. A value of "0" disables reporting.

143-158 - TELEPHONE NUMBER 2

Program the number to be dialed for telephone number 2 in the same manner as programmed in Functions 90 thru 105.

159 - AUDIO LISTEN-IN CAPABILITY (TELEPHONE NUMBER 2)

A value of "1" will enable audio listen-in devices to activate for One (1) minute after receiving the receiver "kiss-off" when the central station is called using telephone #2. (See Function 106).

160 - NUMBER OF RINGS UNTIL AUTO ANSWER

The control may be programmed to automatically pick-up and answer the telephone line after 1 to 15 rings. This Function must be programmed in order for the "auto answer callback method" of remote programming to operate (See "Remote Programming", page 23). Valid range is 0-15. A value of "0" will disable the auto answer callback method.

161-176 - CALLBACK TELEPHONE NUMBER (REMOTE PROGRAMMING)

Enter the callback telephone number of the remote programming computer that the control is to dial when remote programming is enabled. Program the number to be dialed in the same manner as programmed in Functions 90 thru 105. Valid range is 0-15. A value of "15" must be programmed in the location following the last dialing digit. The automatic callback method of remote programming may be disabled by programming the first digit as "15".

177 - TWO DIGIT ARMING

A value of "1" in this location will command the system to arm whenever the first two digits of a user authorization code are entered from a control station. The full code will still be required to disarm.

178 - ENABLE FORCE ARMING

A value of "1" in this location enables force arming. Force arming allows the control to arm even while a zone is faulted. When a user attempts to arm the system with a faulted zone, the control station will emit a 2 second error tone indicating that the control refused to arm. If the code is re-entered within 8 seconds after the tone quits, the control will "force arm" and the faulted zone(s) will be either temporarily or permanently bypassed, depending on the selection of Function 179. If the code is not re-entered within 8 seconds another error tone sounds to indicate that the allowed re-entry time has expired.

179 - TEMPORARY OR PERMANENT FORCE ARMING

A value of "0" in this Function selects "temporary" force arming which allows a zone that has been force armed to automatically be placed back into service when and if restored. A value of "1" selects "permanent" force arming whereby the zone will remain bypassed until the system is disarmed.

Z900 Specifications & Instructions

180 - DELAY BURGLAR ZONE RESTORE REPORT UNTIL ALARM CUT-OFF TIME EXPIRES

In normal operation, a restoral report, if programmed, is transmitted as soon as the zone restores. Entering a value of "1" in this location prevents the communicator from transmitting a restored zone report until after the alarm cut-off time has expired and the zone has restored. If restoral reports are not programmed, this function can still be used to limit transmissions in the event of a continuously triggering detection device. When this function is programmed, the violated zone cannot report another alarm condition until the alarm cut-off time has expired and the zone has restored.

181 - BURGLAR ALARM REPORTS UNTIL LOCKOUT

This function may be programmed to limit the maximum number of successful communicator burglar alarms (from 1 to 15) that may be reported during an armed cycle or timed period. When this value is reached, the communicator will not report another burglar alarm until the system is disarmed and reset or until the 24 hour based automatic test timer expires. This prevents a "runaway" condition which can be caused by a faulty zone or detector. **NOTE: This function effects ONLY burglar defined zone alarms and only locks out after the number of SUCCESSFUL reports. It has no effect on Functions 48 & 49. This Function will not work if Function 193 is also selected.**

182 - PULSING BURGLAR ALARM OUTPUT

A value of "1" instructs the Burglar alarm output to repeatedly pulse, one second on and one second off whenever a Burglar alarm is activated. This applies to outputs derived from the Assignable output (terminal 3) and the optional Z729 Siren Driver/Output Expander. A value of "0" programs the output to be steady.

183 - PULSING AUXILIARY "A" (FIRE ff) ALARM OUTPUT

A value of "1" instructs the Auxiliary "A" alarm output to repeatedly pulse, one second on and one second off whenever an Auxiliary "A" alarm is activated. This applies to outputs derived from the Assignable output (terminal 3) and the optional Z729 Siren Driver/Output Expander. A value of "0" programs the output to be steady.

184 - BURGLAR LOOP AUDIBLE LOCKOUT

A value of "1" instructs the Burglar alarm output to function only once per arm/disarm cycle. This applies to outputs derived from the Assignable output (terminal 3) and the optional Z729 Siren Driver/Output Expander. The communicator, if enabled will continue to send reports as each zone is violated.

185 - MECHANICAL KEYSWITCH MODE CHANGE

A value of "1" in this location allows key switch change of Interior on/off from a key defined zone (see "Key Switch Zone", page 8).

186 - SUPERVISORY/DAY ALERT LATCH

A value of "1" commands the supervisory/trouble condition to latch on until manually cleared by pressing the " * " key .

187 - AUTOMATIC INTERIOR OFF

A value of "1" in this location commands the system to automatically switch the interior defined zones off at the expiration of the exit delay if no delay zones are violated during the exit time. This eliminates the user from having to manually turn interior off if staying in the building. The entrance delay will also be switched off at this time, if Function 191 ("Entrance delay off when interior off") is enabled.

188 - EXTEND BURGLAR LOOP DETECTOR STABILIZATION TIME

Following a total power loss (while the system is armed) the control will ignore all burglar defined zones for 15 seconds to allow detectors time to stabilize. Entering a value of "1" in this location extends this time to 181 seconds. A "0" will provide 15 seconds. See page 13 for more information.

189 - DISABLE INTERIOR FOLLOWER

The control automatically ignores all interior defined zones upon entry through a delay defined zone. This allows the motion detectors to be placed between the entry delay door and the control station. A value of "1" assigned to this Function disables the interior follower feature allowing all interior defined zones to remain instant during the entrance delay period.

190 - INTERIOR ON/OFF (KEY 4) AVAILABLE WHEN CONTROL IS ARMED

A value of "1" in this location will allow the interior on/off selection through key 4 to be operable even if the system is armed. A value of "0" will allow changes to interior on/off status only when the system is disarmed. Turning the interior on/off may also toggle the entrance delay on/off, depending upon programming of Function 191.

191 - ENTRANCE DELAY OFF WHEN INTERIOR OFF

A value of "1" in this location instructs the control to disable the entrance delay whenever the interior defined zones are turned off. A value of "0" disables this feature, leaving the entrance delay intact. The Interior may be turned off manually by pressing and holding key 4. The Interior may be automatically turned off after the expiration of the exit delay if no delay zones are violated by enabling Function 187.

192 - SIREN /BELL TEST UPON ARMING

A value of "1" in this location enables a one second test of the Burglar alarm whenever the control is armed. The Assignable Output (terminal 3) must also be programmed to activate upon a Burglar alarm condition as set by Function 256 and 257 unless output is being achieved through the optional Z729 Siren Driver/Output Expander. The communicator will not report this alarm.

193 - RESET TEST TIMER AFTER SUCCESSFUL REPORT

A value of "1" in this location causes the automatic test timer to reset after receiving a valid kiss-off signal from the central station receiver. The automatic test will occur 24 hrs after the last successful transmission or as set in Function 20.

194 - INTERIOR DEFAULT UPON DISARM

A value of "1" in this location instructs the control to turn the interior off each time the control is disarmed. The entrance delay will also turn off if Function 191 is programmed with a value of "1".

195 - DISABLE KEYPAD SHUNTING

A value of "1" in this location disables the ability to manually shunt zones from the control stations.

196 - DISABLE KEYPAD CHANGE OF INTERIOR ON/OFF (KEY 4)

A value of "1" in this location disables the ability to turn the interior on or off from the control stations.

197 - DISABLE KEYPAD CHANGE OF ZONE CHIME ON/OFF (KEY 6)

A value of "1" in this location disables the ability to turn the zone chime on or off from the control stations.

198 - DISABLE KEYPAD SWITCHED POWER INTERRUPT (KEY 7)

A value of "1" in this location disables the ability to reset a low battery condition and interrupt Switched Power from the control stations.

199 - DISABLE KEYPAD PERFORMED ZONE WALK TEST (KEY 8)

A value of "1" in this location disables the ability to perform a zone walk test from the control stations.

200 - SILENT KEYPAD ON BURGLAR ACTIVATION

A value of "1" in this location instructs all control stations to be silent during a burglar alarm activation. NOTE: If this Function is enabled, a "Fail to Communicate" condition will not annunciate the control station sounder.

201 - DISABLE CONTROL STATION AUDIBLE OR VISUAL INDICATION ON AUXILIARY "B" (POLICE) ACTIVATION

A value of "1" in this location instructs the control stations not to display visual or audible notification of a Auxiliary "B" (police) activation whether activated from the control station zone or a hardwired Auxiliary "B" zone.

202 - START ENTRANCE DELAY 1 UPON KEYPAD ENTRIES

A value of "1" in this location instructs the control to begin entrance delay 1 when a keypad key is pressed while armed. This feature provides additional protection against control station tampering for higher levels of security.

203 - 208 SUPERVISORY/TROUBLE DETECTION ON OPEN OR SHORT? (ZONES 1 - 6)

Any of the 6 hardwire zones may be defined for supervisory/trouble detection by programming of the zone definitions (Functions 41 - 46). Functions 203 through 208 define whether a trouble condition will be detected due to a short or open in the corresponding zone. A value of "0" instructs the control to detect trouble from a loop open and a value of "1" from a loop short. Functions 203 through 208 correspond directly to zones 1 thru 6 respectively (Function 203 = zone 1, 204 = zone 2, etc.).

FUNCTIONS 209 TO 247 ARE USED TO SELECT THE EXTENDED REPORTING DIGITS. IF EXTENDED REPORTING OR 4/2 FORMAT IS NOT UTILIZED SKIP TO FUNCTION 248.

The following Functions are for programming extended reporting codes when an extended reporting format has been selected. If extended reporting is not selected, Functions 209 thru 247 may be skipped. If extended reporting is used, code values possible are 1 thru 15. An extended code of 0 is possible by entering a value of 10 (0 represents the tenth digit). Some receivers receive values of 10 thru 15 as hexadecimal codes A, B, C, D, E, & F.

209-214 - USER AUTHORIZATION CODE 1-6 EXTENDED REPORTING CODES

The value in each location represents the extended code which will identify the corresponding user authorization code used to either arm/disarm, shunt, or cancel an alarm when any of those conditions are programmed to report to the central station receiver.

215 - KEYSWITCH ZONE EXTENDED CODE

The value in this location represents the extended code transmitted whenever the control is armed/disarmed using a key switch zone.

216-221 - ZONE 1-6 EXTENDED ALARM REPORTING CODES

The value in each location represents the extended code which will identify the corresponding hardwire zone when an alarm report is transmitted to the central station receiver.

222-227 - ZONE 1-6 EXTENDED RESTORE REPORTING CODES

The value in each location represents the extended code which will identify the corresponding hardwire zone when a zone restore report is transmitted to the central station receiver.

228-233 - ZONE 1-6 EXTENDED SHUNT REPORTING CODES

The value in each location represents the extended code which will identify the corresponding hardwire zone when a shunted zone report is transmitted to the central station receiver.

234-239 - ZONE 1-6 EXTENDED SUPERVISORY/TROUBLE REPORTING CODES

The value in each location represents the extended code which will identify the corresponding hardwire zone when a supervisory/trouble condition is detected and transmitted to the central station receiver.

240 - EXTENDED AC POWER REPORTING CODE

The value in this location represents the extended code reported when an AC power failure or AC power restoral code is transmitted to the central station receiver.

241 - EXTENDED LOW BATTERY/FUSE BLOWN REPORTING CODE

The value in this location represents the extended code reported when a low battery/blown fuse or battery/fuse restoral code is transmitted to the central station receiver.

242 - EXTENDED MEMORY ERROR REPORTING CODE

Value programmed in this location represents the extended digit reported when an EEPROM memory error condition is transmitted.

243 - EXTENDED TEST REPORTING CODE

Value programmed in this location represents the extended code reported when a communicator test is conducted or upon initial power-up (see Function 55).

244 - EXTENDED KEYPAD PANIC ZONE "A" REPORTING CODE

Value programmed in this location represents the extended code reported when a keypad panic zone "A" alarm is transmitted.

245 - EXTENDED KEYPAD PANIC ZONE "B" REPORTING CODE

Value programmed in this location represents the extended code reported when a keypad panic zone "B" alarm is transmitted.

246 - EXTENDED KEYPAD PANIC ZONE "C" REPORTING CODE

Value programmed in this location represents the extended code reported when a keypad panic zone "C" alarm is transmitted.

247 - EXTENDED MISSING KEYPAD REPORT

Value programmed in this location represents the extended code reported when a missing keypad is detected. This code is used as an identification digit only and will not report unless supervisory/trouble conditions are being reported to the central station receiver.

A missing keypad activates the control station "Trouble" (supervisory/trouble) LED (see "Control Station Power-up and Supervision", page 14).

248 - ELIMINATE BURGLAR ZONE EOLR SUPERVISION

A value of "1" programmed in this location will eliminate the need for end-of-line resistors on all burglar defined hardwired zones. The zones will then be unsupervised closed circuit loops.

249 - RESERVED FOR FUTURE USE - EXITS TO PROGRAMMING MODE (SEE FUNCTION 21)

250 - RESTORE USER CODE 1 DEFAULT VALUE

Entering this location will restore the Master User Authorization Code to its default value (1245). No values may be entered in this location. Because the Master User Authorization Code is required in order to program User Authorization Codes 2-6, this Function will permit the Master Code to be returned to default without having to default the entire memory contents.

251 - "FAST" LOOP RESPONSE TIME 1

Time in milliseconds that a loop violation must be maintained before a fault will be recognized on any hardwired zone defined as "Fast Response". A value of 0=80ms, 1=40ms, 2=80 ms, 3=120ms, 4=160ms, 5=200ms, 6=320ms, 7=480ms, 8=600ms, 9=800ms, 10=1 sec, 11=2 sec, 12=4 sec, 13=6 sec, 14=8 sec, 15=10 sec.

NOTE: 80 milliseconds should be the minimum time programmed and U.L. requires that loop response not exceed one second (a value of 10).

252 - "SLOW" LOOP RESPONSE TIME 2

Time in milliseconds that a loop violation must be maintained before a fault will be recognized on any hardwired zone defined as "Slow Response". Program in the same manner as Function 251.

253 - RESERVED FOR FUTURE USE - EXITS TO PROGRAMMING MODE (SEE FUNCTION 21)

254 - RESTORE FACTORY DEFAULTS (NEW EEPROM VALUES)

Factory default EEPROM values may be restored by first entering a "1" in this location, and then exiting the program mode. After exiting, the control will restore all factory defaults after approximately 5 seconds. Function 250 allows the Master User Authorization Code to be defaulted by itself without having to default the entire control.

NOTE: This function replaces all installer and user level programming values returning the control to factory default values as shipped and disables all central station communication.

255 - INSTALLER PROGRAM AUTHORIZATION CODE

The installer program authorization code is used to gain entry into the installer level programming mode. This code MUST be 5 digits in length. The code at default is 96321.

256 - ASSIGNABLE OUTPUT DEFINITION

This Function determines the type of condition that will activate the +12VDC Assignable Output (terminal 3). Select the desired condition from the table below and enter into Function 256. If Function 256 is programmed for output upon Alarm conditions (value of "0"), one or more of Functions 257-260 must be programmed with a value of "1" to determine the type of alarm condition(s) desired.

Value Programmed (Function 256)	+12VDC Output from Terminal 3 upon:	Value of "1" Programmed in Function:	The Following "Alarm Conditions" Provide +12VDC Output:
0	Alarm Condition(s) as determined by Functions 257-260	257	Burglary
1	Sw. Power reset (Key 7)/Auto Tests	258	Auxiliary "A" (Fire ff)
2	Activation of Access	259	Auxiliary "B" (Police)
3	Supervisory/Trouble Conditions	260	Auxiliary "C" (Emergency)
4	Entrance pre-alarms and Chime		

TABLE 8 ASSIGNABLE OUTPUT (terminal 3) DEFINITION

257 - BURGLAR ALARM ACTIVATES ASSIGNABLE OUTPUT (terminal 3)

A value of "1" instructs the control to provide +12VDC from Assignable Output (terminal 3) whenever a Burglar alarm activates. A value of "0" disables this feature. Function 256 must also be programmed with a value of "0" to enable the terminal 3 to respond to Alarm conditions.

258 - AUXILIARY "A" (FIRE ff) ACTIVATES ASSIGNABLE OUTPUT (terminal 3)

A value of "1" instructs the control to provide +12VDC from the Assignable Output (terminal 3) whenever an Auxiliary "A" alarm activates. A value of "0" disables this feature. Function 256 must also be programmed with a value of "0" to enable the terminal 3 to respond to Alarm conditions.

259 - AUXILIARY "B" (POLICE) ACTIVATES ASSIGNABLE OUTPUT (terminal 3)

A value of "1" instructs the control to provide +12VDC from the Assignable Output (terminal 3) whenever an Auxiliary "B" alarm activates. A value of "0" disables this feature. Function 256 must also be programmed with a value of "0" to enable the terminal 3 to respond to Alarm conditions.

Z900 Specifications & Instructions

260 - AUXILIARY "C" (EMERGENCY) ACTIVATES ASSIGNABLE OUTPUT (terminal 3)

A value of "1" instructs the control to provide +12VDC from the Assignable Output (terminal 3) whenever an Auxiliary "C" alarm activates. A value of "0" disables this feature. Function 256 must also be programmed with a value of "0" to enable the terminal 3 to respond to Alarm conditions.

261 - DISABLE KEYPAD PANIC ZONE "A" (FIRE ff)

A value of "1" disables the keypad activated panic zone "A" (FIRE ff) from operation. Default is "0" (enabled).

262 - DISABLE KEYPAD PANIC ZONE "B" (POLICE)

A value of "1" disables the keypad activated panic zone "B" (POLICE) from operation. Default is "0" (enabled).

263 - DISABLE KEYPAD PANIC ZONE "C" (EMERGENCY)

A value of "1" disables the keypad activated panic zone "C" (EMERGENCY) from operation. Default is "0" (enabled).

264 - RESERVED FOR FUTURE USE - EXIT TO PROGRAMMING ENTRY MODE (SEE FUNCTION 21)

265 - TONE TEST GENERATION FACTORY USE ONLY. NO VALUES MAY BE PROGRAMMED INTO THIS LOCATION.

266 - FACTORY ID FACTORY USE ONLY. NO VALUES MAY BE PROGRAMMED INTO THIS LOCATION.

267 - TELEPHONE NUMBER 1 UPLOAD/DOWNLOAD COMPLETED REPORTING CODE

The reporting code which may be sent to the central station immediately after an upload/download session is completed.

268 - TELEPHONE NUMBER 2 UPLOAD/DOWNLOAD COMPLETED REPORTING CODE (Program in same manner as 267).

269 - EXTENDED UPLOAD/DOWNLOAD COMPLETED REPORTING CODE

The extended reporting code which may be sent to the central station immediately after an upload/download session is completed.

270 - DIAL TONE DETECTION/1 ALARM PER ZONE UNTIL DISARM

This provides flexibility with Telco switching equipment found in many foreign countries. If this option is enabled, each zone can activate only 1 alarm per armed cycle. Upon disarm the zone restoral, if programmed, will be transmitted and the lockout will be reset. Note: Function #181 will be overridden (ignored) when this option is enabled. See chart below for programming this feature.

Programming Function 270 with a value of:

0 = Normal operation-US pulse dial make/break ratio

1 = Foreign pulse dial make/break ratio of 67/33

2 = 9 second wait for dial tone

3 = *Selects both options 1 and 2

4 = Blind dialing disabled. No dial without dial tone

5 = *Selects both options 1 and 4

6 = *Selects both options 2 and 4

7 = *Selects options 1, 2, and 4

8 = Allow 1 alarm per zone until disarm. (Overrides F #181)

9 = *Selects both options 1 and 8

10 = *Selects both options 2 and 8

11 = *Selects options 1, 2, and 8

12 = *Selects both options 4 and 8

13 = *Selects options 1, 4, and 8

14 = *Selects options 2, 4, and 8

15 = *Selects ALL options 1,2, 4, and 8

271 - KEYPAD PANIC 3 SECOND (HOLD OR PRESS TWICE) MODE

Each keypad panic zone is activated by momentarily pressing its designated emergency key. A value of "1" will instruct the control to ignore momentary emergency key presses and require the keypress to be maintained for three seconds (or to be pressed at least twice within three seconds). Default = "1" (3 second mode).

272 - BUILT-IN "RING COUNT" ANSWER MACHINE BYPASS

There are now 2 methods for bypassing answering machines. A new two-call "Ring Count" method is built into the Z920 V2.0 software. This method is triggered by two calls occurring within a programmable time window. The original "tone detection" method, which required an optional Z233 Answer Command Module, remains compatible with both existing and new controls. It may still be desirable to use the tone detection method on jobs where the number and frequency of calls might be a problem. To trigger the built-in Answer Machine bypass feature:

Step 1 From a standard phone, manually dial the control and allow at least 1, but no more than 2 rings, then hang-up.

Step 2 Wait 8 seconds, then re-dial the Control using the Dial command from Transport-PC. The control will answer the 2nd call on the 1st ring, provided the ring occurs within a programmable time window. Function #272 sets the maximum time window for the 2nd call in 10 second increments, up to a total of 150 seconds (range of 0-15). A zero (0) disables the feature. If the maximum time window is exceeded on the 2nd call, the control will ignore the 1st ring and reset the process. Best results occur when the time window is set for 20 or 30 seconds (a value of 2 or 3). Avoid setting this window too long! If you incur an answering machine which picks up on the 1st ring, a small amount of additional time delay may be required after the 1st call, to allow the machine to release the line.

NOTE: Function #160, which sets the standard rings till answer, MUST be programmed with a value greater than 0 in order for the built-in "Ring Count" answer bypass feature to operate.

273 -PROGRAMMABLE LISTEN-IN ACTIVATION TIME

It is possible to select the amount of time (from 1 to 15 minutes) that the communicator will hold the telephone line after receiving a kiss-off signal from a central station receiver.

Specifications



TECHNICAL SPECIFICATIONS

Z900 Control Board:

- Six (6) two wire zones each supervised with a 2,200 ohm end-of line resistor.
- Three(3) keypad activated zones.
- Nominal current drain for control board only: 42 milliamps.
- Watchdog microprocessor monitoring circuit.
- Superior 4 stage lightning/transient protection.
- One assignable high current alarm output.
- Low voltage detection monitoring @ 11.2 Volts threshold.
- Automatic system shutdown if voltage falls below 7.5 volts.
- Operating temperature range inside the enclosure: 32°F to 122°F (0°C to +50°C).

Power Supply:

- Full 1.5 Amp regulated.
- Less than 200 millivolts AC ripple.
- Regulated 13.8 Volts DC 900 milliamps continuous output. (See Table 10 for C.S.F.M. limits).
- Reverse polarity protection on battery inputs.
- Float charging circuit: 13.8 Volts DC.
- Fused outputs for: Auxiliary 2 power and Assignable Output (5mm x 20mm standard acting 2.5A); Keypad/Auxiliary 1 power and Switched power (5mm x 20mm standard acting 2.5A).

Recommended Battery:

- Rechargeable 12 Volt 4 Amp-hour (B1240) or 12 Volt 6 Amp-hour (B1260) sealed lead acid.

Transformer (T1635):

- U.L listed class II plug-in, 16.5 volt AC, 35 VA secondary, 120 volt 60 Hz primary.

Enclosure:

- Twenty (20) gauge metal cabinet with knockout for optional cam lock. Dimensions: 9" W x 10" H x 2.875" D (228.6mm x 254mm x 73.02mm).

Digital Communicator:

- Touchtone® or Rotary (pulse) dialing. Rotary speed: 10pps,(selectable 60% break, 40% make or 66% break, 33% make).
- Ringer equivalence: 0.0B.
- Transmission formats include: Slow (10 or 15 baud), fast (20 or 40 baud), Radionics superfast (30 baud) and BFSK®.
- Reports to most major central station receivers.
- Primary and secondary phone numbers up to 16 digits.
- Dual reporting capability.

Control Station (Z900R):

- Color coded four (4) wire hookup.
- Twelve button keypad with audible and tactile feedback.
- Three emergency panic zone keys.
- Mounts to any standard single or double gang electrical box.
- Ten (10) LEDs provide total system and zone status.
- Built-in piezo sounder.
- Nominal current drain: 20 mA all LEDs off, 60mA all LEDs and piezo sounder on.
- Up to 7 per system. (See Table 4-1 for U.L. and C.S.F.M. limits).
- Size: 4.55" H x 6.80" W x .90" D (115.57mm x 172.72mm x 22.86mm).
- Color: Bone white with gray labeling.

CSFM Listing Number: 7167-1459: 102

Z900 FEATURES

- Ready to install with a factory basic program.
- Programmable from Z900R and Z700R control stations.
- Upload/Download programming and control from a remote location using an IBM PC ® or compatible, a Hayes ® modem, and TRANSPORT-PC software.
- Six (6) User Authorization codes.
- Programmable communicator lockout of burglar defined zones to limit runaway reporting.
- EEPROM memory retains arm/disarm status, alarm memory, and programming after total power loss.
- Self-diagnostics with memory error detection and reporting.
- Six (6) hardwire zones programmable as burglar, 24 hr Auxiliary "A" (fire ff), Auxiliary "B" (police), Auxiliary "C" (emergency), and communicator report only.
- Three keypad activated panic zones.
- A single zone may be programmed for keyswitch arm/disarm.
- Burglar zones may be defined as instant or delay (2 delay timers), interior or perimeter, silent instant, priority (non-shuntable), slow or fast loop response.
- All hardwire zones may be programmed for supervisory/trouble condition latching or momentary.
- Individual or group zone shunt (bypass) from touchpad.
- Zone force arm with full shunt, or restore when zone restores.
- Zone auto shunt or auto restore after alarm.
- 24 hour zones may be programmed as shuntable.
- Programmable Timers: Entry Delay 1 and 2, Exit Delay, Access, Alarm Cut-off, and Delay before audible burglar alarm output.
- Programmable loop response of 40 msec. to 10 seconds.
- Eight (8) second invalid or inactive control station timeout and 3 minute programming timeout.
- Continuous monitoring of control panel fuses.
- Optional siren/bell test upon arming.
- Optional timed or latched access (door strike) output.
- Missing control station detection with communicator report.
- Digital Communicator Reporting Capabilities:
 - 3 or 4 digit account codes.
 - 1 or 2 digit alarm codes.
 - Report by zone.
 - Single or 2 line extended.
 - Two separate Account codes.
 - Hexidecimal reporting.
 - Dual reporting
 - Split reporting.
 - Opening or Closings by User Code.
 - Shunted zone(s) reported upon arming.
 - Exception openings by User Code.
 - Individual zone and or system restore.
 - Cancel/Abort report by User code.
 - Supervisory/trouble by zone.
 - Low battery and battery restoral.
 - AC failure and AC restoral.
 - Automatic test every 12 hours or 1 to 7 days.
 - Delay before dial.
 - Dial attempts for telephone number one and two.
 - Optional fail-to-communicate annunciation.
 - One (1) minute listen-in on Telephone number 1 or 2.

OPTIONAL ACCESSORIES

- TRANSPORT-PC:** Upload/Download software package.
- MPI-230 Chip Duplicator:** Low cost handheld duplicator for copying a program from one control to another.
- Z729 Siren Driver/Output Expander:** Plugs directly into the control board to provide a two channel high power siren driver and separate 40 mA trigger outputs for Burglar, Aux. "A", Aux. "B", Aux. "C", Armed, Ready, Violation, Pre-alarm, Lamp, Access and additional taps for Auxiliary 1 power and common negative termination (Same outputs as Z1100 family connector J16).
- Z232 Relay/Ground Start Module:** For use with phone lines that require a momentary ground to obtain dial tone.
- Z233 Answer Command Module:** Allows Upload/Download Auto Answer mode to operate on telephone lines which have an answering machine attached.
- MPI-267 Power Disconnect Module:** Automatically disconnects battery to prevent deep discharge if battery voltage drops below 7.5 volts, plus provides ON/OFF power switch.

Z700, Z900 and TRANSPORT-PC are trademarks of Sentrol, Inc.

IBM ® is a registered trademark of International Business Machines, Inc.

Hayes ® is a registered trademark of Hayes Microcomputer Products, Inc.

Touchtone ® is a registered trademark of American Telephone & Telegraph, Inc.

BFSK ® is a registered trademark of Radionics, Inc.

- Made in USA.

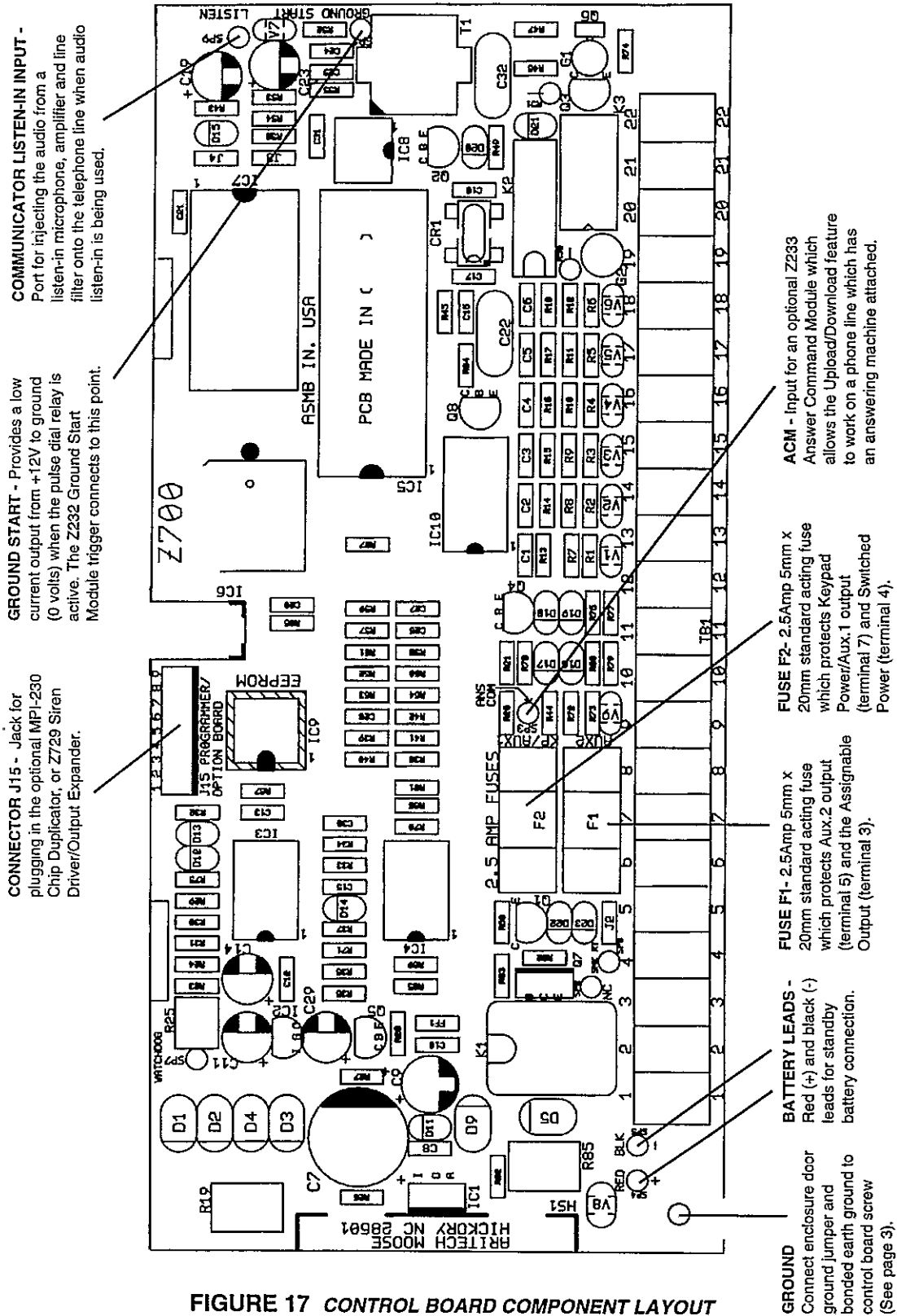

FIGURE 17 CONTROL BOARD COMPONENT LAYOUT

Z900 Specifications & Instructions

Application	Listing	Maximum Current drain (millamps)	Min. Battery Standby Time in hours	Z900R/Z700R Control Stations	ESL Smoke Detector Model 449AT, ESL Model 204-12/24V Power Supervision Unit	Auxiliary Equipment
Non U.L. Listed		900	3	7	N/A	
C.S.F.M Approved		450	24	6	Required	Wheslock 34T-12 Horn

Maximum combined continuous current drain (standby) refers to terminals 3, 4, 5, 7, and Connector J15. Under Alarm conditions, the combined output current drain should not exceed 1.5 Amps. CSFM requires two 12 volt, 7Amp-hour batteries.

TABLE 10 CONFIGURATIONS AND CURRENT DRAIN PROVISIONS

N.F.P.A. Requirements

5

NATIONAL FIRE PROTECTION ASSOCIATION (NFPA) RULES

The National Fire and Burglar Alarm Association (NFPA) has established rules to follow pertaining to fire prevention and the installation of fire detection equipment.

FIRE PROTECTION

☐ SMOKE DETECTOR LOCATION

Smoke detectors should be installed in accordance with the National Fire Protection Association (NFPA) Standard 72. Figure 18 illustrates detector placement.

The following is from NFPA 72: Smoke detectors shall be installed outside of each separate sleeping area in the immediate vicinity of the bedrooms and on each additional story of the family living unit including basement and excluding crawl spaces and unfinished attics (see Figure 18). In new construction, a smoke detector also should be installed in each sleeping room. For family living units with one or more split levels (i.e., adjacent levels with less than one full story separation between levels), a smoke detector required by the above shall suffice for an adjacent lower level, including basements.

EXCEPTION: Where there is an intervening door between one level and the adjacent lower level, a smoke detector shall be installed on the lower level.

Ceiling mounted smoke alarms should be located in the center of the room or hall, not less than 4 inches from any wall. When the detector is mounted on a wall, the top of the detector should be 4 to 12 inches from the ceiling.

Do not install smoke alarms where normal ambient temperatures are above 100°F (37.8°C) or below 40°F (4°C).

Also, do not locate smoke detectors in front of air conditioners, heating registers, or other locations where normal air circulation will keep smoke from entering the detector.

Heat from a fire rises to the ceiling, spreads out across the ceiling surface and begins to bank down from the ceiling. The corner where the ceiling and wall meet is an air space into which heat has difficulty in penetrating. In most fires, this 'dead' air space measures about 4 inches (0.1m) along the ceiling from the corner and 4 inches (0.1m) down the wall as shown in Figure 18. Heat or smoke detectors should not be placed in this 'dead' air space.

☐ FIRE PREVENTION AND ESCAPE

The purpose of heat and smoke detectors is to detect a fire in its earliest stages and sound an alarm, giving occupants more time to exit the premises before smoke reaches a dangerous level.

☐ KNOW FIRE HAZARDS

No detection device can protect life in all situations; therefore, safeguards should be taken to avoid such potentially dangerous situations as smoking in bed, leaving children home alone, and cleaning with flammable liquids such as gasoline.

The best fire protection is minimizing fire hazards through proper storage of materials and good housekeeping practices. Careless use of combustible materials and electrical appliances or overloading of electrical outlets are major causes of fire. Explosive and fast burning materials must be eliminated from the home.

☐ IN CASE OF FIRE

Leave immediately! Do not stop to pack or search for valuables. In heavy smoke, hold your breath and stay low — crawl if necessary. The clearest air usually is at the floor. If you have to go through a closed door, carefully feel the door and door knob to see if undue heat is present. If relatively cool, brace your foot against the bottom of the door with your hip against the middle, and one hand against the top edge. Open slightly. If there is a rush of hot air, slam the door quickly and latch it. Unvented fire will build up considerable pressure. Be sure that all the household realizes this danger.

Use your neighbors phone or street fire alarm box. The job of extinguishing the fire should be left to the professionals. Too many unforeseen things can occur when inexperienced people try to extinguish a fire.

☐ BE PREPARED

Perform fire drills regularly. Use them to assure recognition of an alarm signal. For your protection, simulate different circumstances (smoke the hall, living room, etc.). Then have everyone react to the situation. Draw a floor plan and show two exits from each room.

Z900 Specifications and Instructions

It is important that children be instructed carefully. Their tendency is to hide in a crisis.

It is imperative that one meeting place outside the home be established. You should insist that everyone meet there during an alarm. This will eliminate the tragedy of someone re-entering the house for a missing member who is actually safe.

If you have small children and/or invalids residing in your household, you can help your fire department by placing decals on bedroom windows. Most fire departments supply the decals.

Become familiar with the distinctive sounds of your Fire alarm and Burglar alarm signals.

Consult smoke detector specifications and local and national codes for coverage descriptions.

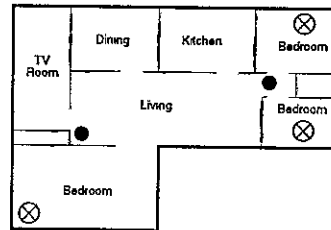
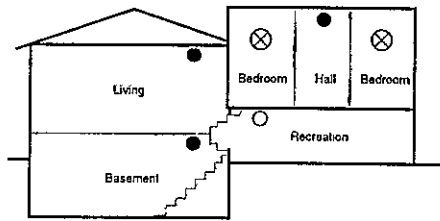
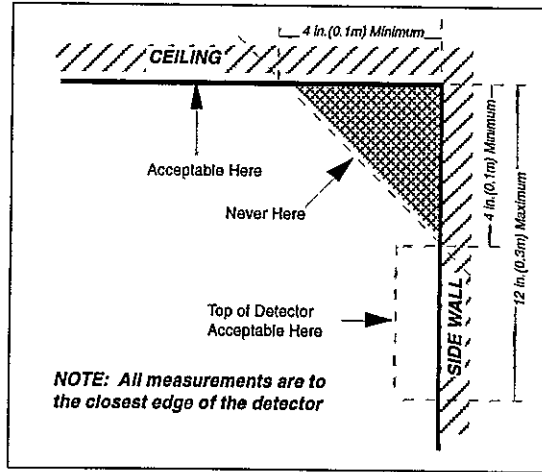

- Indicates required smoke detector
- Indicates smoke detector is optional if door is not provided between living and recreational rooms.
- ⊗ Indicates smoke detector required in new construction.

In family living units with more than one sleeping area, a smoke detector should be provided to protect each sleeping area in addition to the detectors required in bedrooms.

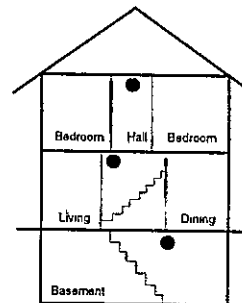

A smoke detector should be located on each story.

FIGURE 18 SMOKE DETECTOR PLACEMENT

A

AC failure 6, 13, 16
 AC transformer 4, 5, 6, 39
 ACM 41
 Access 17, 27
 Alarm, resetting see "Resetting alarms"
 Alarm LED 14, 15, 16
 Alarm memory 17, 18
 Answer Command Module (Z233) 41
 Answering machines 23
 Arming/disarming 14
 Assignable Output 4, 5, 10, 11, 15
 Audio listen-in 41
 Auxiliary alarms, resetting 14, 15
 Auxiliary Power 1 see "Keypad/Auxiliary Power 1"
 Auxiliary Power 2 4, 5, 10
 Auxiliary zones see "Twenty-four hour Auxiliary zones"

B

Battery see "Standby battery"
 Bell 4
 Burglar alarms, resetting 14
 Bypassing see "Shunting"

C

Cam lock 2
 Chime 16, 17
 Chip Duplicator (MPI-230) 19
 Class "B" end-of-line resistor supervised zones 6, 7
 Closed circuit loop 7
 Communicator
 general 24
 failure to communicate 16, 27
 report only zones 8
 reporting capabilities 40
 specifications 39
 transmission formats 29
 Computer see "Remote Programming"
 Conduit 3
 Configuration digit 27
 Connector J15 11, 41, 42
 Control board 2, 39
 Control board component layout 41
 Control station
 data in/out 4, 5, 8, 10
 hardware pack 2

Control station (continued)

 LEDs 15
 mounting 9
 operation 15
 parts list 2
 power-up 14
 specifications 39
 supervision 14
 troubleshooting 9
 wiring 8
 zones 11
 zone operation 15
 CSFM approval 42
 Current drain (limitations) 10, 42

D

Default
 program 19
 restoring 22
 Delay on/off 16
 Diagnostic features 16
 Diagnostic Overlay 16, 18
 Digital communicator see "Communicator"
 Disarming see "Arming/disarming"
 Duress see "Arming/disarming" 27

E

Earth ground 3, 4, 41
 EEPROM inside front cover, 13
 Emergency panic zones 11, 15
 Enclosure 2, 39
 End-of-line resistor 6
 Exit delay beep (silencing) 23

F

Fail to communicate see "Communicator"
 Find key 20
 Fire inside front cover, 14
 Float battery voltage 4
 Force arming 23
 Function
 definition 19
 descriptions 25-38
 map (description) 21
 reading value 20

Z900 Specifications & Instructions

Fuses (F1/F2) 9, 41
Fuses (F1/F2) continued
see also "Low Battery/Blown Fuse"

G

Ground see "Earth ground"
Ground start 41
Ground wire lug 3

H

Hardwire zones 6, 7, 8
High Security Arm/Disarm Code 14, 24, 27

I

Installer Program Authorization Code 19
Interior on/off 16, 17

J

J15 see "Connector J15"

K

Key switch zone 8
Keypad/Auxiliary Power 1 4, 5, 10
Knockouts, enclosure 2, 3

L

Layout, Typical Installation 1
Lightning/transient protection 3, 4
Line seizure see "Telephone"
Limitations inside front cover
Listen-in see "Audio Listen-in"
Low battery/Blown fuse 16

M

Master User Authorization Code 14, 19, 25
Memory error 16
Missing keypad 16
Monitor see "Chime"
Mounting the enclosure 3
MPI-206 see "Relay Module" (MPI-206)

MPI-230 see "Chip Duplicator"
MPI-267 see "Power Disconnect Module"

N

Negative termination 5
Next key 20
Non-shuntable zones see "Priority Zones"
Non-supervised closed circuit loop . see "Closed circuit loop"

O

Operating temperature range 3, 39
Optional accessories 40
Outputs see specific type of output desired

P

Panic keys 11, 15
Planning 1
Power Disconnect Module (MPI-267) 6
Power failure (AC/DC) 13
Power supply 39
Power-up (control) 13
Priority Zones 24
Program (key 9) 17
Program mode, exiting 21
Program Functions see "Functions"
Programming
 default (restoring) 21
 installer level 19-21
 remote 23
 special features 23
 timer 19
 user level 22

R

Ready LED 15
Relay Module (MPI-206) 11
Remote programming 23
Reset 17
Resetting alarms 14, 15
ROM 13

S

Seizure see "Telephone"
Shuntable zones 24
Shunting 15, 17

Siren driver
 Z729 Siren Driver/Output Expander 11, 15, 23, 41
 wiring 10

Smoke detector
 resetting 5, 10
 wiring 4, 10

Specifications 39

Standby battery
 general 4, 6
 float battery voltage/maximum current 4
 quiescent charge current 4
 recommended 39
 replacement 4

Step voltage blowout 3

Store key 20

Supervisory/trouble 6, 16, 24

Switched Power 4, 5, 10

Switched power interrupt 17

T

Telephone
 general 12
 cord (TC-3 direct connect cord) 4
 FCC compliance 4, inside rear cover
 Ringer equivalence 12, 39
 hook-up 4, 5, 12
 line seizure 12, 24
 line supervision 4
 RJ-31X/RJ-38/X jack 4, 12
 testing 12

Temperature range see "Operating temperature range"

Test 17

Timer (8 second programming) 19

Transformer see "AC transformer"

Transients see "Lightning/transient protection"

Trouble key 16, 17

Trouble LED 13, 15, 16, 17

Twenty-four hour Auxiliary zones 8

Twenty-four hour communicator report only zones 8

U

Upload/download 23

Unified earth ground see "Earth ground"

Usage count 25

User Authorization Code 14, 19, 25

User level programming 14, 19, 22

User operation 14

W

Watchdog Monitor inside front cover, 13

Z

Z729 see "Siren Driver"

Z233 see "Answer Command Module"

Z900R see "Control Station"

Zone LEDs 14, 15, 15

Zone bypassing see "Shunting"

Zone definition 27

Zone planning 20

Zone shunting see "Shunting"

Zone wiring 7

Notes

A large, empty rectangular box with a thin black border, intended for handwritten notes. The box occupies most of the page area below the 'Notes' header.

Notes

A large, empty rectangular box with a thin black border, occupying most of the page. It is intended for the user to write their notes.

Notes

A large, empty rectangular box with a thin black border, intended for the user to write notes. The box occupies most of the page area below the 'Notes' header.

FCC COMPLIANCE

PART 68 NOTIFICATION

This equipment complies with Part 68 of the Federal Communications Commissions (FCC) rules. All connections to the telephone network must be made through standard telephone company plugs and jacks, RJ31-X or equivalent, in such a manner as to allow for easy and immediate disconnection of the equipment. If the connecting cord is unplugged from the jack, there shall be no interference to the telephone equipment still connected to the telephone network.

The FCC registration number and Ringer Equivalence Number (REN) can be found printed on the wiring connection label located inside the Control Box Enclosure. If requested, provide this information to your telephone company. The REN is useful to determine the quantity of devices that may be connected to your telephone line and still have all of those devices ring when your number is called. In most, but not all, areas, the sum of the RENs of all devices should not exceed five (5.0).

In the unlikely event that the equipment should ever fail to operate properly, it should be disconnected from the telephone jack to determine if the problem is with the telephone network or with the equipment. If a problem is found with the equipment, leave it disconnected until it is repaired or replaced.

In the unlikely event that the equipment should ever cause harm to the telephone network, the telephone company may temporarily discontinue your service. If possible, they will notify you in advance. However, if advance notice isn't practical, the telephone company may temporarily discontinue service without prior notification. In the case of temporary discontinuance, the telephone company shall promptly notify the telephone subscriber who will be given the opportunity to correct the situation. The customer also has the right to bring a complaint to the FCC if he feels the disconnection is not warranted.

Your telephone company may make changes in its facilities, equipment, operations, or procedures that could affect the proper operation of your equipment. If they do, you will be given advance notice so as to give you an opportunity to maintain uninterrupted service.

You should notify the telephone company if this equipment is removed from the premises and the telephone jack is no longer needed. The FCC prohibits the connection of this equipment to party lines and the use of this equipment in conjunction with coin-operated telephone service.

An AC surge arrester should be installed in the system's AC power outlet.

PART 15 NOTIFICATION

This equipment has been tested and found to comply with the limits for a Class B digital device, pursuant to Part 15 of the FCC rules. These limits are designed to provide reasonable protection against harmful interference when the equipment is operated in a residential environment. This equipment generates, uses, and can radiate radio frequency energy and, if not installed and used in accordance with the instruction manual, may cause harmful interference to radio communications. However, there is no guarantee that interference will not occur in a particular installation. If this equipment does cause harmful interference to radio or television reception, which can be determined by turning the equipment off and on, the user is encouraged to try to correct the interference by one or more of the following measures:

- Reorient or relocate the receiving antenna.
- Increase the separation between the equipment and the receiver.
- Connect the equipment into an outlet on a circuit different from that to which the receiver is connected.
- Consult the dealer or an experienced radio/TV technician for help.

CAUTION: Changes or modifications not expressly approved by the manufacturer could void the user's authority to operate the equipment.

CANADIAN NOTICE

The Canadian Department of Communications label identifies certified equipment. This certification means that the equipment meets certain telecommunications network protective, operational and safety requirements. The Department does not guarantee that the equipment will operate to the user's satisfaction. Before installing this equipment, users should ensure that it is permissible to be connected to the facilities of the local telecommunications company. The equipment must also be installed using an acceptable method of connection. In some cases, the company's inside wiring associated with a single line individual service may be extended by means of a certified connector assembly (telephone extension cord). The customer should be aware that compliance with the above conditions may not prevent degradation of service in some situations. Repairs to certified equipment should be made by an authorized Canadian maintenance facility designated by the supplier. Any repairs or alterations made by the user to this equipment, or equipment malfunctions, may give the telecommunications company cause to request the user to disconnect the equipment. Users should ensure for their own protection that the electrical ground connections of the power utility, telephone lines and internal metallic water pipe system, if present, are connected together. This precaution may be particularly important in rural areas.

CAUTION

Users should not attempt to make such connections themselves, but should contact the appropriate electric inspection authority, or electrician, as appropriate.

The **LOAD NUMBER** (LN) assigned to each terminal device denotes the percentage of the total load to be connected to a telephone loop which is used by the device, to prevent overloading. The termination on a loop may consist of any combination of devices subject only to the requirement that the total of the Load Numbers of all the devices does not exceed 100.

This equipment is a Class B Digital apparatus which complies with the radio interference regulations, CRC c. 1374.

MOOSE 

A PRODUCT OF SENTROL, INC

SENTROL CONTROLS GROUP

PO Box 2904

1510 Tate Blvd. SE

Hickory, NC 28603

Sales: 800.547.2556

Fax: 503.691.7566

Technical Support: 800.800.2027

Sentrol, Inc. reserves the right
to change specifications
without notice.

©1995 Sentrol, Inc.

64812438G