

managed ethernet switches

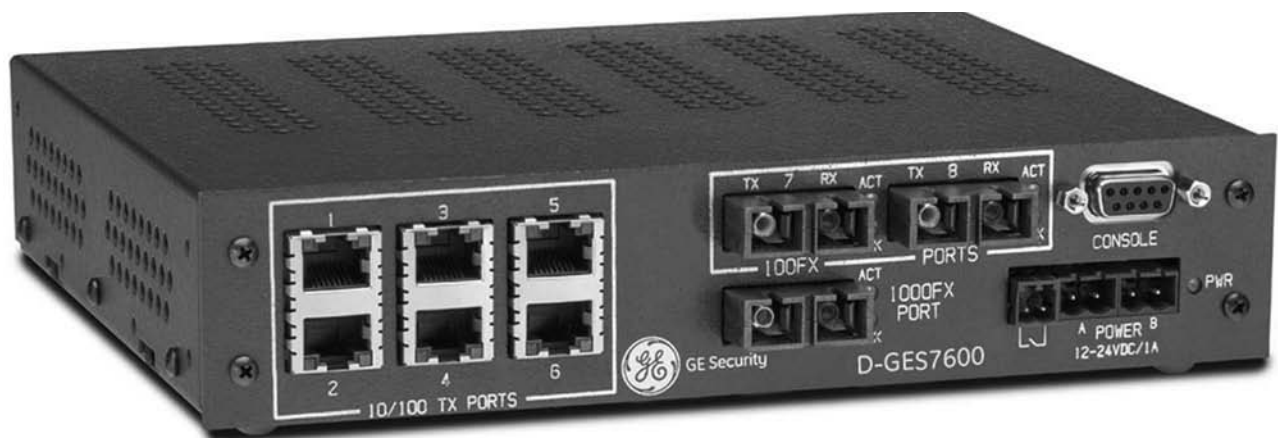

D-GES7600 Series Installation & Operation Instructions



imagination at work

PREFACE

This manual describes how to install and use the D-GES7600 series EtherNav™ Manageable 8/9-Port 10/100/1000 Base-TX (100/1000 Base-FX) Ethernet Switch. This switch integrates full wire speed switching technology with SNMP/RMON web-based management functions. The D-GES7600 series brings a simple answer to today's complicated networking environments.

To get the most out of this manual, you should have an understanding of Ethernet networking concepts.

In this manual, you will find:

- Features on the Switch
- Illustrative LED functions
- Installation Instructions
- Management Configuration
- SNMP..
- Specifications

INSTALLATION & OPERATION MANUAL / D-GES7600

PREFACE

TABLE OF CONTENTS

PRODUCT OVERVIEW

Package Contents.....	1
Product Features.....	1
<i>Basic Features</i>	1
<i>Management Support</i>	2
Front Panel Display.....	3
Physical Ports.....	4
Basic Functions.....	5
<i>Unicast Switching</i>	5
<i>Multicast Switching</i>	7
VLAN.....	8
<i>Broadcast Containment</i>	9
<i>Multi-Based Multimedia Applications</i>	9
<i>Enhanced Security</i>	9
<i>VLAN Membership</i>	9
<i>VLAN Configuration</i>	10
<i>Intra-VLAN Communication</i>	10
<i>Inter-VLAN Communication</i>	10
GVRP.....	10
IGMP Snooping and IP Multicast Filtering.....	10
Switch Management.....	11
INSTALLATION	12
Selecting A Site For The Switch.....	12
Methods for Mounting the D-GES7600.....	12-15
Connecting To Power.....	16
<i>Power-On Self Test (POST)</i>	16
Connecting To Your Network.....	17
<i>Cable Type & Length</i>	17
SWITCH MANAGEMENT	18
Management Access Overview.....	18-19
Administration Console.....	20
<i>Direct Access</i>	20
Web Management.....	21
<i>Netscape Navigator</i>	21
<i>Internet Explorer</i>	21

INSTALLATION & OPERATION MANUAL / D-GES7600

SWITCH MANAGEMENT CONTINUED....

SNMP-Based Network Management.....	22
Protocols.....	22
Management Architecture.....	22

MENU-DRIVEN CONSOLE MANAGEMENT..... 23

Logging On To The Switch.....	23
<i>At The Screen Prompt</i>	23
Switch Management Screen.....	24
<i>Navigating Through The Console Interface</i>	25
Performing Basic Management Activities.....	25-31
<i>Alarm Configurations</i>	32
Performing Advanced Management Activities.....	33-62
Sending and Receiving Files.....	63-64
Logout.....	65
Save Settings.....	65
Restore Default Settings.....	65
Reboot.....	65

WEB-BASED BROWSER MANAGEMENT..... 66

Logging On To The Switch.....	66
Understanding The Browser Interface.....	67
Performing File Activities.....	68
<i>To Perform File Activities</i>	68
Performing Basic Setup Activities.....	69
<i>To Perform Basic Setup Activities</i>	69-73
Performing Advanced Setup Activities.....	74
<i>To Perform Advanced Setup Activities</i>	74-86

SNMP & RMON MANAGEMENT..... 87

Overview.....	87
SNMP Agent and MIB (RFC 1213).....	87
<i>RMON Groups Supported</i>	88
<i>Bridge Groups Supported</i>	89

SPECIFICATIONS..... 90

APPENDIX A – CONNECTOR PINOUTS..... 91

PRODUCT OVERVIEW

Manageable 8/9-Port Switch

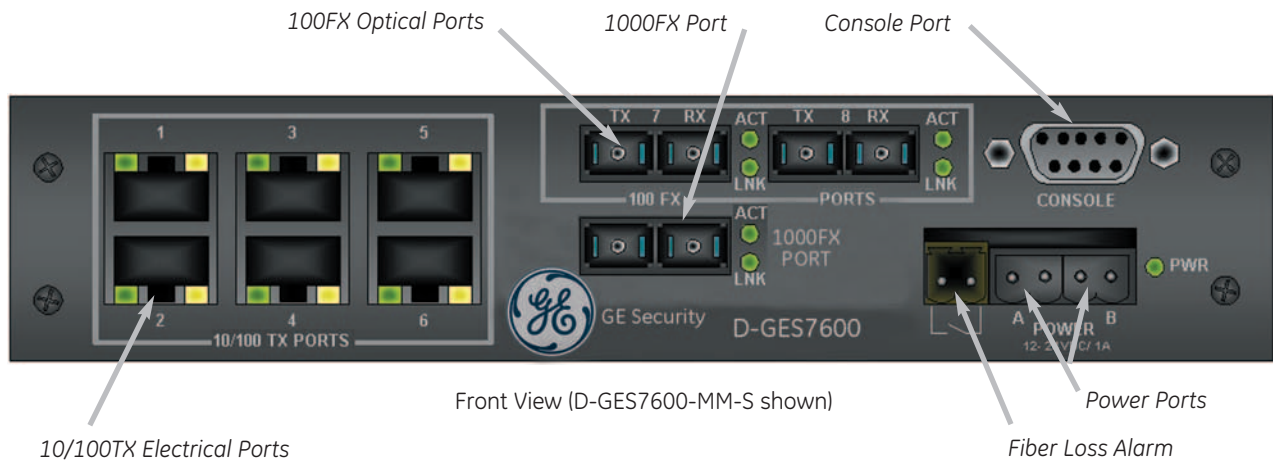

PACKAGE CONTENTS

When you unpack the product package, you shall find the items listed below.

- D-GES7600 EtherNav™ Management Switch
- D-GES7600 Quick Start Guide
- External Power Adapter
- CD ROM User's Manual

PRODUCT FEATURES

Basic Features:

- Provides up to nine (10/100/1000 TX and/or 100/1000 FX combination) ports
- Multimode fiber using SC connectors up to 2 km; singlemode fiber using SC connectors up to 15 km for 100FX, 10km for 1000FX
- Auto-negotiation for speed and duality on all TX ports
- Store-and-Forward mechanism
- Back-pressure and IEEE 802.3x compliant flow control
- Supports 4K MAC addresses
- Redundant power supply connections
- Optional TX or FX 1000Mbps aggregation port
- Optional contact closure for fiber loss alarm

PRODUCT FEATURES CONTINUED...

Management Support:

VLAN

- 802.1Q tagged VLAN (up to 64 VLANs)
- Quality of Service (QoS)

Link Aggregation

- Port-based Aggregation, up to four groups with a maximum of four ports each group
- Load sharing based on source and destination MAC addresses

Port-Mirroring

- Port-mirroring provided through dedicated port, Port 1

Internet Working Protocols:

Bridging

- 802.1D Spanning Tree
- 802.1P/Q -GARP/GVRP

IP Multicast

- IP Multicast Packet Filtering

Network Management Methods:

- Console port access via RS-232 cable
- Telnet remote access
- SNMP Agent:
 - MIB-2 (RFC1213)
 - Bridge MIB (RFC1493)
 - RMON MIB (RFC1757)-statistics, history, alarm & events
 - VLAN MIB (802.1Q/RFC2674)
 - Private MIB
- Web browser support based on HTTP server and CGI parser
- TFTP/Web software-upgrade capability

FRONT PANEL DISPLAY

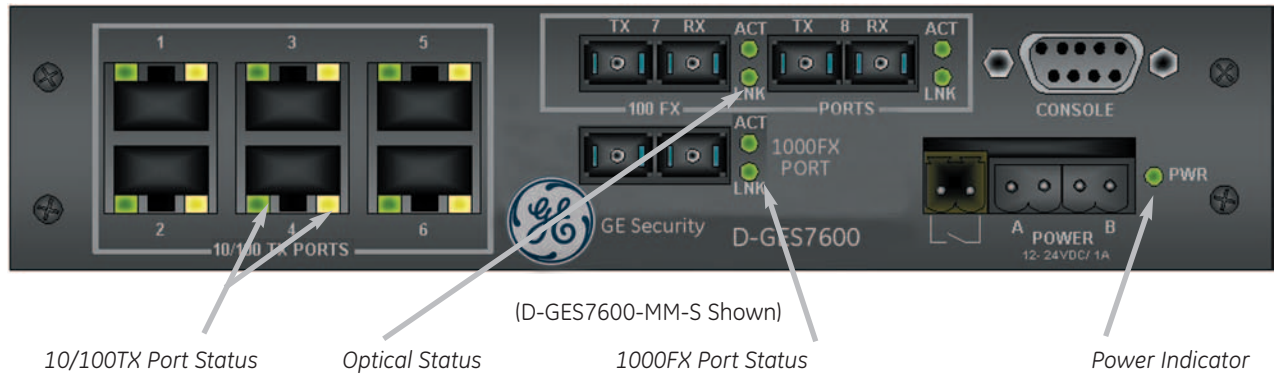

1. Power Indicator

This LED comes on when the switch is properly connected to power.

2. Optical Status LED's (FX)

The ACT LED's come on when data is present.
 (LED will flash at the rate data is transferred).
 The LNK LED's will be on for 100FX speed transmission.

3. 10/100/1000TX Port Status LED's

The LED's are located at each port, displaying status.
 Please refer to the Table for more details.

LED	State	Indication
GREEN	Steady	A valid network connection established
YELLOW	Flashing	Data transfer

LED	State	Indication
GREEN	Steady	A valid network connection established
YELLOW	Flashing	Data transfer

PHYSICAL PORTS

This EtherNav™ managed switch provides up to nine (10/100/1000TX and/or 100/1000FX combinations) ports:

CONNECTIVITY

- RJ-45 connectors
- SC connector on fiber ports

MODE SELECTION

- 10BaseT full-duplex mode
- 10BaseT half-duplex mode
- 100BaseTX full-duplex mode
- 100BaseTX half-duplex mode
- 100BaseFX full-duplex mode
- 100BaseFX half-duplex mode
- 1000BaseTX full-duplex mode
- 1000BaseTX half-duplex mode
- 1000BaseFX full-duplex mode
- 1000BaseFX half-duplex mode
- Auto-sensing mode except 100FX

PLEASE NOTE:

- I. Half-duplex mode uses back pressure flow control to prevent the receiving buffer from being overrun by data from a source node.
- II. Full-duplex mode uses 802.3x flow control standard to prevent fast data traffic from overrunning slow data traffic.
- III. Auto-sensing mode is in use after auto-negotiating with the other end of the link.

BASIC FUNCTIONS

In general, the D-GES7600 is responsible for switching both VLAN tagged and untagged frames from a receiving port to one or more transmitting ports. The switch performs multiple steps during the switching process:

VLAN CLASSIFICATION

LEARNING

FILTERING

AGING

Below is additional information about tasks that the switch performs during unicast and multicast switching.

UNICAST SWITCHING

VLAN CLASSIFICATION

When the switch receives a frame, it classifies the frame in one of two ways:

- If the frame is untagged, the switch classifies the frame to an associated VLAN.
- If the frame is tagged, the switch uses the tagged VLAN ID to identify the broadcasting domain of the frame.

PLEASE NOTE:

- I. Half-duplex mode uses back pressure flow control to prevent the receiving buffer from being overrun by data from a source node.
- II. Full-duplex mode uses 802.3x flow control standard to prevent fast data traffic from overrunning slow data traffic.
- III. Auto-sensing mode is in use after auto-negotiating with the other end of the link.

LEARNING

After VLAN classification, the switch checks the <source MAC address, VLAN> pair in the switching database (SDB) to see whether the <source MAC address, VLAN> pair is known.

- If it is unknown, the switch inserts the <source MAC address, VLAN> into the SDB and learns the <source MAC address, VLAN>.
- If it is known, the switch checks the <source MAC address, VLAN> for a mismatched port ID. If the port ID associated with the <source MAC address, VLAN> pair in the SDB is different than the receiving port, the switch modifies the port ID in the SDB and modifies its management database (MDB) accordingly.

FILTERING

After learning the address, the switch checks:

- Whether the source port or destination port is in the forwarding state.
- Whether the source MAC address or destination MAC address is to be filtered.
- Whether the source port ID is the same as destination port ID.

If any of these conditions are met, the switch drops the receiving. Otherwise, it continues with the forwarding process described below.

FORWARDING

During the forwarding process, the switch checks whether the <destination MAC address, VLAN> pair is unknown.

- If it is unknown, the switch floods the receiving frame to all ports in the VLAN, excluding the source port.
- If it is known, the switch forwards the receiving frame to the port associated with the <destination MAC address, VLAN> pair. At the same time, the switch ascertains the individual's ports VLAN tagging and/or un-tagging configuration and corresponding VLAN ID render the appropriate frame tagging when the frame is ready to be transmitted.

MULTICAST SWITCHING

For multicast switching, the D-GES7600 checks whether the received frame is a BPDU. If a BPDU is received, the switch forwards the frame to the CPU for processing by the spanning tree protocol. Otherwise, the D-GES7600 performs the following processes:

VLAN CLASSIFICATION

Same as for unicast switching.

LEARNING

Same as for unicast switching.

FILTERING

After learning the address, the switch checks:

- Whether the source port or destination port is not in the following state.
- Whether the source MAC address or destination MAC address is to be filtered.

If any of these conditions are met, the switch drops the receiving. Otherwise, it continues with the forwarding process described below.

FORWARDING

The D-GES7600 floods the received multicast frame to all ports that are in the forwarding state within the VLAN, excluding the source port. At the same time, the switch ascertains the individual ports VLAN tagging/untagging configuration and corresponding VLAN to render the appropriate frame tagging when the frame is ready to be transmitted.

AGING

The switch performs the aging process for the <MAC addresses, VLAN> pair in the switching database. Once a <MAC address, VLAN> pair is aged out, the SBD is modified.

SPANNING TREE

The D-GES7600 supports one Spanning Tree per bridged network.

VLAN

A virtual LAN (VLAN) is a network of computers or peripherals that behave as if they are connected to the same wire, even though they may actually be physically located in different locations of a LAN. VLANs are similar to a group of end stations, perhaps on multiple physical LAN segments that are not inhibited by their physical location and can communicate as if they were on a common LAN.

VLANs are configured through software rather than hardware, which makes the extremely flexible. One of the biggest advantages of VLANs is that when a peripheral is physically moved to another location, it can stay on the same VLAN without any hardware reconfiguration.

Because VLANs are not limited by the hardware constraints that physically connect traditional LAN segments to a network, they can define a network into various logical configurations. For example, VLANs can define a network by function.

In this setting, a system integrator might create one VLAN for multimedia users and another for email users. VLANs can also define a network by location or type of service. For example, a location might have one VLAN for its cameras, another for its access control, and another for its roadside signs.

VLANs can also be set up according to the organization structure within a company. For example, the company president might have his/her own VLAN, the executive staff might have a different VLAN, and the remaining employees might have yet another different VLAN.

As these examples show, VLANs offer matchless flexibility. The following sections describe how deploying VLANs can benefit system integrators and reduce design costs.

BROADCAST CONTROL

In traditional networks, traffic broadcasts to all network devices, whether they are the intended recipients or not. However, VLANs can be set up to contain only those devices that need to communicate with each other. As a result, VLANs considerably reduce network congestion. In addition, VLANs prevent broadcast storms from causing a network from crashing due to volumes of traffic.

MULTICAST-BASED MULTIMEDIA APPLICATIONS

Multimedia applications, such as interactive training, video monitoring, and video/data transmissions, require large amounts of bandwidth. These applications are also extremely sensitive to variable delays, which are inevitable on a shared Ethernet network. By defining a VLAN based on the IP multicast address for all defined members on the VLAN, adequate bandwidth will be available for these applications, providing true multimedia Ethernet.

IMPROVED SECURITY

Because VLANs are independent, only the devices within the same VLAN can communicate with each other. If a device in one VLAN wants to communicate with a device in another VLAN, the traffic must go through a router.

VLAN MEMBERSHIP

VLAN implementation allows:

- Up to 64 VLANs in one switch.
- VLANs across multiple switches by using explicit or implicit tagging and the GARP/GVRP protocol defined in IEEE802.1p and 802.1Q.
- An end station's network interface card belongs to multiple VLANs.
- A switch port to be associated with multiple VLANs.

DEFINITIONS OF VLAN MEMBERSHIP

VLAN implementation allows VLAN membership to be defined based on ports. Physical port numbers organizes port-based VLANs. For example, switch ports 1,2,4 and 6 can be grouped on VLAN, while server ports 3, 5, 7 and 8 can be on another VLAN. Broadcasts from servers within each group would only go to the members of its own VLAN. This ensures that broadcast storms cannot cause a network to crash due to volumes of traffic.

VLAN MEMBERSHIP LEARNING

Port-based VLAN is defined using a static binding between a VLAN and its associated ports. The switch's forwarding decision is based on the destination MAC address and its associated port ID. Therefore, to make valid forwarding and flooding decisions, the switch learns the relationship of the MAC address to its related port...and thus to the VLAN...at runtime.

REMOTE VLAN MEMBERSHIP

Additionally to providing network management tools that allow network administrators to statically add and delete VLAN member ports, the switch also supports GVRP (GARP VLAN Registration Protocol). GVRP allows for dynamic registration of VLAN port members within switch and across multiple switches.

Other than supporting dynamic updating of registration entries in a switch, GVRP is used to communicate VLAN registration information to other VLAN-aware switches, so that a VLAN member can cover a wide span of switches on a network.

GVRP allows both VLAN-aware workstations and switches to issue and revoke VLAN memberships. VLAN-aware switches register a propagate VLAN membership to all ports that belong to the active topology of the VLAN.

VLAN CONFIGURATION

The switch provides a Local/Remote Management Console Interface for VLAN configuration and management. An SNMP-based VLAN MIB is also provided.

INTRA-VLAN COMMUNICATION

The switch supports intra-VLAN communication through hardware as described in "Basic Functions" section.

INTER-VLAN COMMUNICATION

The switch supports Inter-VLAN communication using CPU-based routing software.

GVRP (GARP VLAN Registration Protocol)

In addition to network management tools that allow network administrators to statically add and delete VLAN member ports, the routing switch supports GARP VLAN Registration Protocol (GVRP). GVRP supports dynamic registration of VLAN port members within a switch and across multiple switches.

In addition to dynamically updating registration entries with a switch, GVRP is used to communicate VLAN registration information to other VLAN-aware switches, so that members of a VLAN can cover a wide span of switches on a network.

GVRP allows both VLAN-aware workstations and switches to issue and revoke VLAN memberships. VLAN-aware switches register and propagate VLAN membership to all ports that are part of the active topology of the VLAN.

IGMP SNOOPING AND IP MULTICAST FILTERING

The Internet Group Management Protocol (IGMP) runs between hosts and their immediately neighboring multicast routers. The protocol's mechanisms allow a host to inform its local router that it wants to receive transmissions addressed to a specific multicast group.

Routers periodically query the LAN to determine if known group members are still active.

IGMP Snooping & IP Multicast Filtering Continued...

If there is more than one router on the LAN performing IP multicasting, one of the routers is elected 'querier' and assumes the responsibility.

Based on the group membership information learned from the IGMP, a router can determine which (if any) multicast traffic needs to be forwarded to each of its 'leaf' sub-networks. Multicast routers use this information, along with a multicast routing protocol, to support IP multicasting across the Internet.

Routing switches support IP Multicast Filtering by:

- Passively snooping on the IGMP Query and IGMP Report packets transferred between IP Multicast Routers and IP Multicast host groups to learn about IP Multicast group members, and
- Actively sending IGMP Query messages to solicit IP Multicast group members.

The purpose of IP multicast filtering is to optimize a switched network's performance, so multicast packets will only be forwarded to those ports containing multicast group hosts members and routers instead of flooding to all ports in the subnet (VLAN).

Routing switches with IP multicast filtering/switching capability not only run passively monitor IGMP Query and Report messages, DVMRP Probe messages, PIM, and MOSPF Hello messages; they also actively send IGMP Query messages to learn locations of multicast routers and member hosts in multicast groups within each VLAN.

Note, however, IGMP neither alters nor routes any IP multicast packets. Since IGMP is not concerned with the delivery of IP multicast packets across sub-networks, an external IP multicast router is needed if IP multicast packets have to be routed across different sub-networks.

SWITCH MANAGEMENT

Administration Console Via RS-232 Console Port:

The switch provides an on board serial port, which allows the switch to be configured via a directly connected terminal or a Telnet session.

Web-Based Browser Interface:

The switch also boasts a point-and-click browser-based interface that lets users access full switch configuration and functionality from a Netscape or Internet Explorer browser.

External SNMP-Based Network Management:

The switch can also be configured via SNMP.

For more information on switch management, please refer to the "Switch Management" section.

INSTALLATION

This section gives step-by-step instructions about how to install the EtherNav™ D-GES7600 switch:

Selecting a Site for the Switch

As with any electric device, you should place the switch where it will not be subjected to temperatures, humidity, or electromagnetic interference above the rated specifications. The site you select should meet the following requirements:

- The ambient temperature should be between -40 to 74 degrees Celsius.
- The relative humidity should be less than 95 percent, non-condensing.
- Surrounding electrical devices should not exceed the electromagnetic field (RFC) standards for EIC 801-3, Level 2 (3V/M) field strength.
- Make sure that the switch receives adequate ventilation. Avoid blocking the ventilation holes on all sides of the switch.

Methods for Mounting the D-GES7600

Several mounting configurations are available for the variety of applications for which this switch was designed. Each configuration is described as follows:

Wall or Floor Mounting (-W Option)

The brackets provided will require the removal and re-installation of the cover screws as shown below.

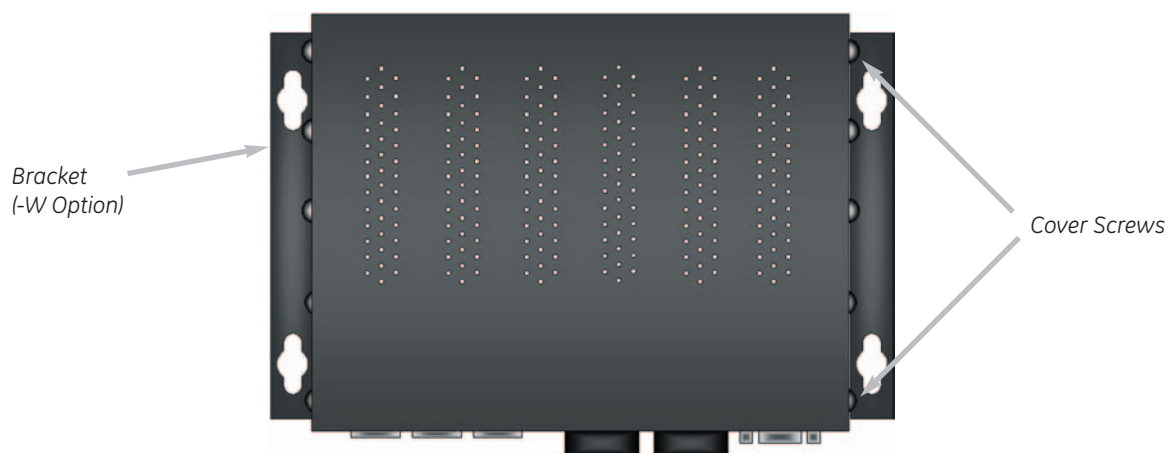

Note: Insure that all screw are re-installed for adequate stability in mounting.

DIN Rail Back Mounting (-DB Option)

The bracket provided will require the removal and re-installation of some cover screws as shown below.

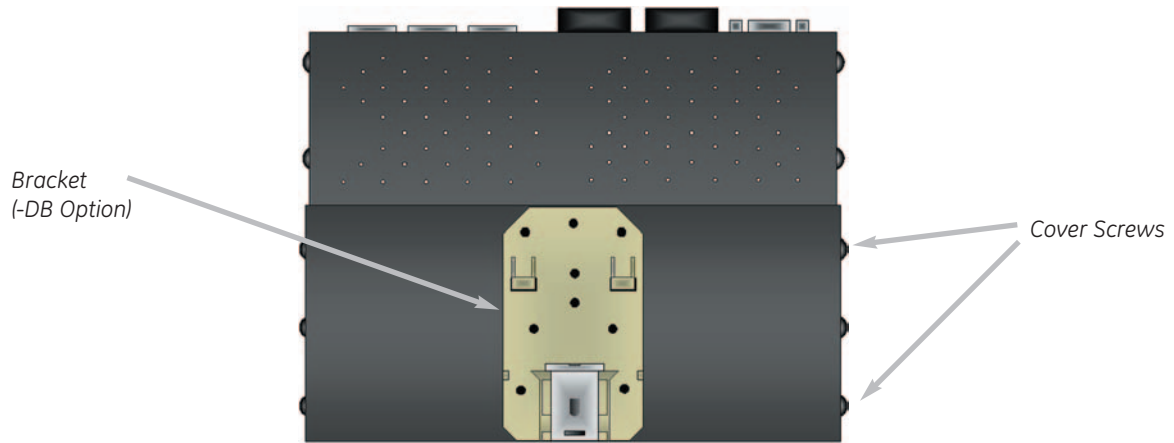

DIN Rail Side Mounting (-DS Option)

The bracket provided will require the removal and re-installation of one cover screw, the other screws are provided with the bracket as shown below.

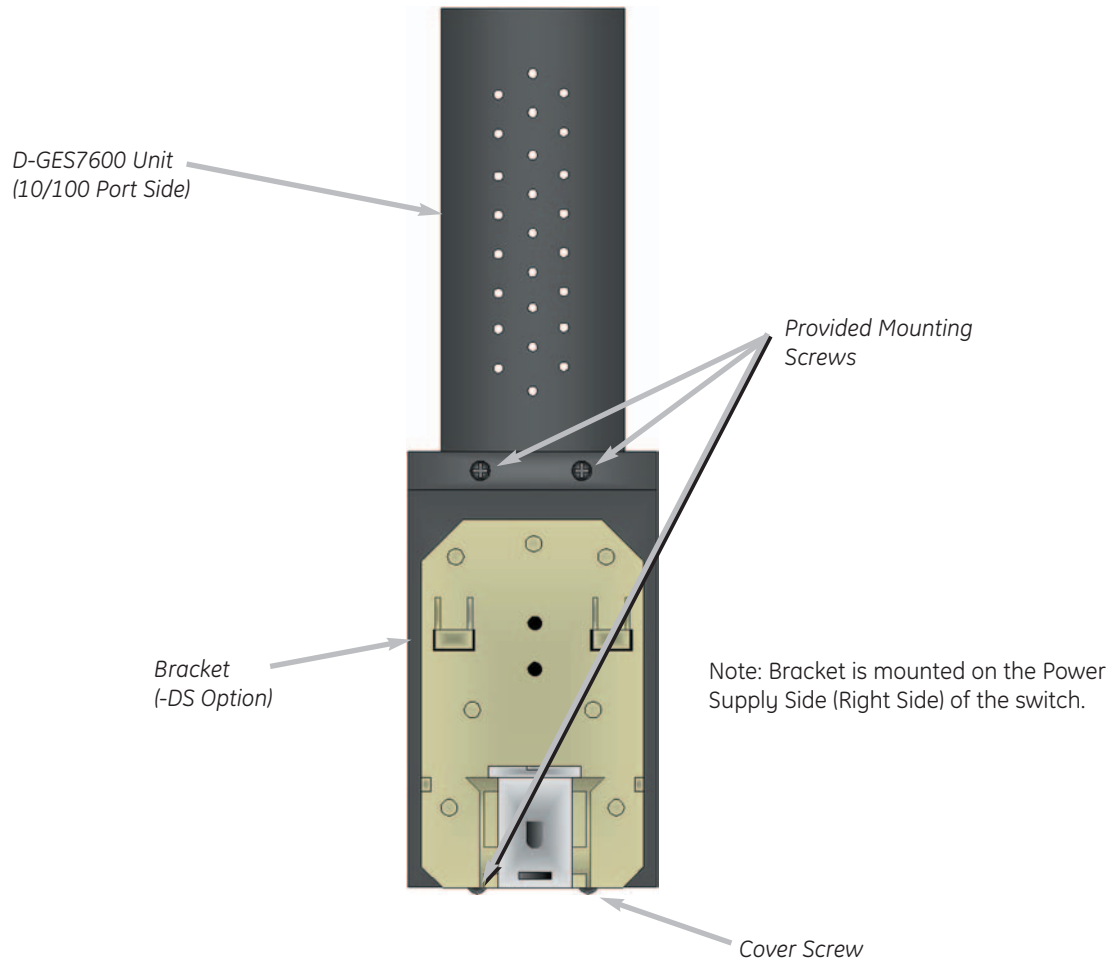

Rack Mounting Single Unit (-RS Option)

The brackets provided have screws included for proper mounting as shown below.

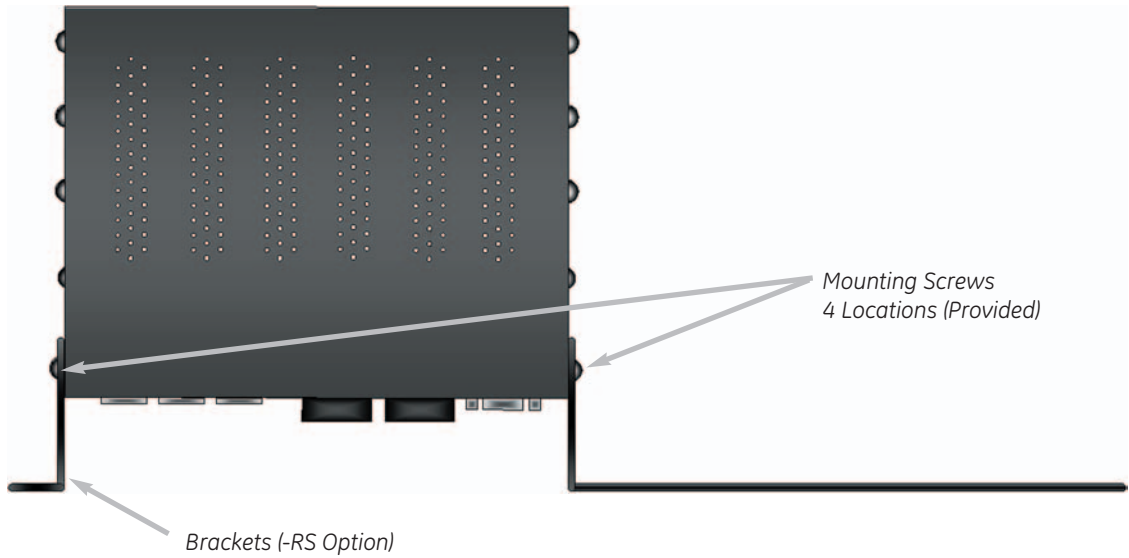

(Top View)



(Front View)

Note: All screws must be fastened and secured to insure adequate stability and strength.

Rack Mounting Dual Units (-RD Option)

The brackets and braces provided have screws included for proper mounting as shown below.



(Front View)

Brackets (2 Provided)



Brace (2 Provided)

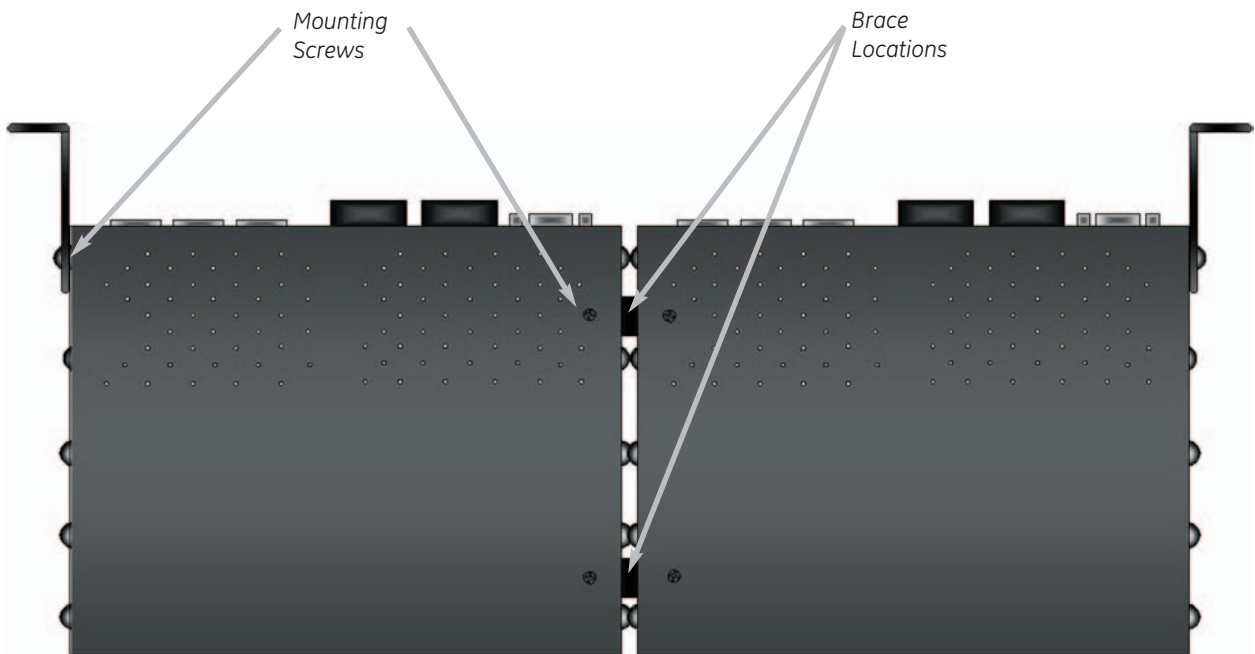

(Bottom View)

CONNECTING TO POWER

External Power

Step One: Wire the supplied AC power adapter to the “A” receptacle plug at the front of the switch. — white stripe to pin 1 (+), black to pin 2 (-).

Step Two: Attach the plug into a standard AC outlet with the appropriate AC voltage.

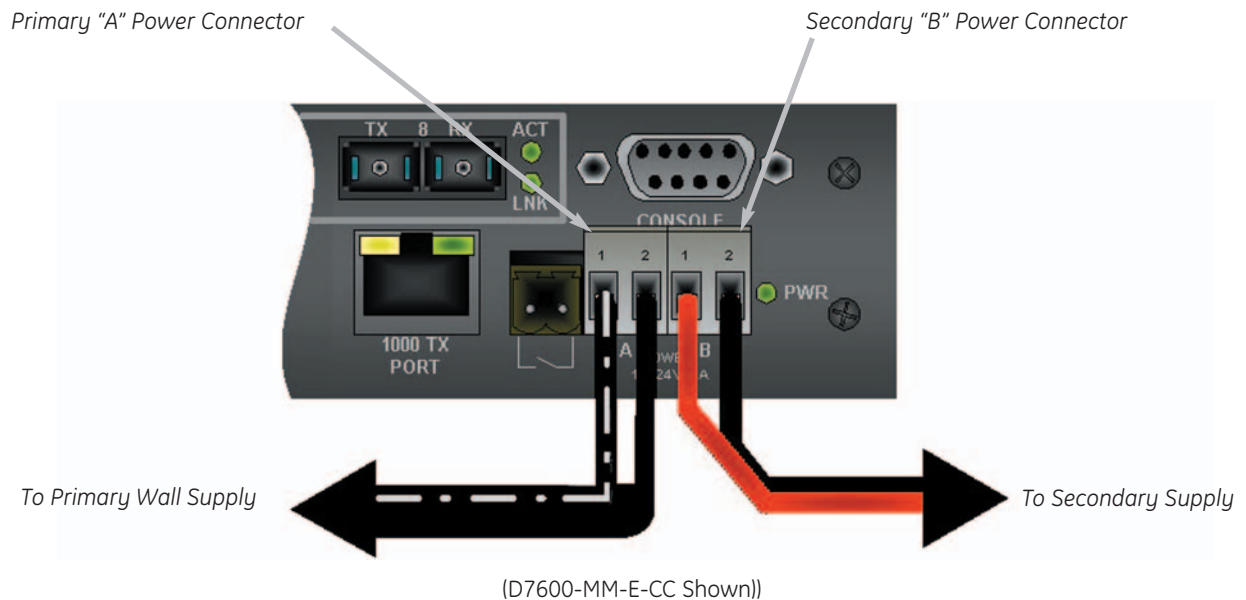

Note: The secondary supply must be equal to or less than the potential of the primary supply.

Power-On Self Test (POST)

The switch performs its Power-On Self Test (POST) when the power is applied to the switch. During the POST, the switch CPU will:

- Perform a series of diagnostic procedures to make sure the basic system is functioning properly
- Decompresses the main switching software runtime image from the flash ROM into the DRAM area

CONNECTING TO YOUR NETWORK

Cable Type & Length

Wire the supplied AC power adapter to the “A” receptacle plug at the front of the switch. — white stripe to pin 1 (+), black to pin 2 (-).

Step Two: Attach the plug into a standard AC outlet with the appropriate AC voltage.

It is necessary to follow the cable specifications below when connecting the switch to your network. Use appropriate cables that meet your speed and cabling requirements.

Table 3: Cable Specifications

Speed	Connector	Port Speed Half /Full Duplex	Cable	Max. Distance
10BaseT	RJ-45	10/20 Mbps	2-Pair UTP/STP Cat. 5, 5E, 6	100 m
10BaseTX	RJ-45	100/200 Mbps	2-Pair UTP/STP Cat. 5, 5E, 6	100 m
1000BaseTX				
100BaseFX	SC	100/200 Mbps	MMF (50 or 62.5µm) <u>-25dB Return</u> <u>Loss Minimum</u>	2 km
100BaseFX	SC	100/200 Mbps	SMF (9 or 10µm) <u>-25dB Return</u> <u>Loss Minimum</u>	37 km
100BaseFX-HP				54 km
100BaseFX-HP1				97 km
1000BaseFX	SC	500/1000 Mbps	SMF (9 or 10µm) <u>-25dB Return</u> <u>Loss Minimum</u>	28 km

Cabling:

- Step 1:** First, ensure the power of the switch and end devices are turned off.
NOTE: Always ensure that the power is off before any installation.
- Step 2:** Prepare cable with corresponding connectors for each type of port in use.
- Step 3:** Consult Table 3 in previous section for cabling requirements based on connectors and speed.
- Step 4:** Connect one end of the cable to the switch and the other end to a desired device.
- Step 5:** Once the connections between two end devices are made successfully, turn on the power and the switch is operational.

SWITCH MANAGEMENT

This section explains the methods that you can use to configure management access to the switch. It describes the types of management applications and the communication and management protocols that deliver data between your management device (workstation or personal computer) and the system. It also contains information about port connection options.

This section covers the following topics:

- Management Access Overview
- Key Concepts
- Key Guidelines for Implementation
- Administration Console / Telnet Access
- Web Management Access
- SNMP Access
- Standards, Protocols, and Related Reading

MANAGEMENT ACCESS OVERVIEW

The EtherNav™ D-GES7600 switch gives you the flexibility to access and manage the switch using any or all of the following methods.

The administration console and web browser interface support are embedded in the switch and are available for immediate use.

Administration Console via RS-232 Console Port:

Advantages:

- No IP address or subnet needed
- Text-based
- HyperTerminal built into Windows 95/98/NT/2000 operating systems

Disadvantages:

- Must be near switch
- Inconvenient for remote users

Web-Based Browser Interface:

Advantages:

- Ideal for configuring the switch remotely
- Compatible with all popular browsers
- Can be accessed from any location
- Most visually appealing

Disadvantages:

- Security can be compromised (hackers need only know the IP address and subnet mask)
- May encounter lag times on poor connections

Telnet Interface:

The connection is the same as Web-Based Browser Interface, but with Console Port Hyper Terminal type user interface.

External SNMP-Based Network Management Application:

Advantages:

- Communicates with functions at the MIB level
- Based on open standards

Disadvantages:

- Requires SNMP manager software
- Least visually appealing of all three methods
- Some settings require calculations
- Security can be compromised (hackers need only know the community name)

ADMINISTRATION CONSOLE

The administration console is an external, character-oriented, menu-driven user interface for performing system administration such as displaying statistics or changing option settings.

Using this method, you can view the administration console from a terminal, personal computer, Apple Macintosh, or workstation connected to the switch's console port.

There are two ways to use this management method: direct access or mode Telnet access. The following sections describe these methods:

DIRECT ACCESS

Direct access to the administration console is achieved by directly connecting a terminal or a PC equipped with a terminal-emulation program (such as Hyper-Terminal) to the switch console port.

When using the management method, configure the terminal-emulation program to use the following parameters (you can change these settings after login):

[Default Parameters]	115, 200bps
	8 Data Bits
	No Parity
	1 Stop Bit
	Flow Control None

This management method is often preferred because you can remain connected and monitor the system during systems reboots. Also certain error messages are sent to the Console port regardless of the interface through which the associated action was initiated. A Macintosh or PC attachment can use any terminal-emulation program for connecting to the terminal serial port. A workstation attachment under UNIX can use an emulator such as TIP.

Telnet ACCESS

You can access the switch's administration console from a PC or Macintosh using DOS window through network with IP address. The switch management program provides a **CONSOLE PORT** screen, accessible from the **BASIC MANAGEMENT** screen, that lets you configure parameters for remote access.

WEB MANAGEMENT

The switch provides a browser interface that lets you configure and manage the switch remotely.

After you set up your IP address for the switch, you can access the switch's web interface applications directly in your web browser by entering the IP address of the switch. You can then use your web browser to list and manage switch configuration parameters from one central location, just as if you were directly connected to the switch's console port.

Web Management requires either Microsoft Internet Explorer 4.01 or later or Netscape Navigator 4.03 or later.

- **Netscape Navigator**

If you use Netscape Navigator 4.03 or 4.04, install the Netscape JDK 1.1 Patch. Download the patch from:

<http://help.netscape.com/filelib.html#smartupdate>

If you encounter problems accessing Help files when you use Netscape, clear the browser memory cache and disk cache, and restart the browser.

- **Internet Explorer**

If you use Internet Explorer, install the latest 4.01 Service Pack 1. This service pack makes Internet Explorer Year 2000 compliant and fixes other product-support issues. Download the 4.01 Service Pack 1 from the following location:

http://www.microsoft.com/msdownload/iebuild/ie4sp1_win32/en/ie4sp1_win3

If the above link is unavailable, download the service pack from the Microsoft home page:

<http://www.microsoft.com>

SNMP-BASED NETWORK MANAGEMENT

If you enable the SNMP function through the console port, you can use an external SNMP-based application to configure and manage the switch. This management method requires the SNMP agent on the switch and the SNMP Network Management Station to use the same community string. This management method, in fact, uses two community strings: the 'get' community string and the 'set' community string. If the SNMP Network management station only knows the 'set' community string, it can read and write to the MIBs. However, if it only knows the 'get' community string, it can only read MIBs. **The default getting and setting community strings for the switch are public.**

PROTOCOLS

The switch support the following protocols:

- Virtual Terminal Protocols, such as Telnet

A virtual terminal protocol is a software program, such as Telnet, that allows you to establish a management session from a Macintosh, a PC, or a UNIX workstation. Because Telnet runs over TCP/IP, you must have at least one IP address configured on the switch before you can establish access to it with a virtual terminal protocol.

Note: Terminal emulation is different from a virtual terminal protocol in that you must connect a terminal directly to the console port.

Simple Network Management Protocol (SNMP)

SNMP is the standard management protocol for multi-vendor IP networks. SNMP supports transaction-based queries that allow the protocol to format messages and to transmit information between reporting devices and data-collection programs. SNMP runs on top of the User Datagram Protocol (UDP), offering a connectionless-mode service.

Management Architecture

All of the management application modules use the same Messaging Application Programming Interface (MAPI). By unifying management methods with a single MAPI, configuration parameters set using one method (e.g. console port) are immediately displayed as the other management methods (e.g. SNMP agent or web browser).

The management architecture of the switch adheres to the IEEE open standard. This compliance assures customers that the switch is compatible with, and will interoperate with other solutions that adhere to the same open standard.

MENU-DRIVEN CONSOLE MANAGEMENT

The switch provides a menu-driven console interface for configuration purposes. The switch can be configured either locally through its RS-232 port or remotely via a Telnet session.

This section describes how to configure the switch using its menu-driven console.

Logging On To The Switch

At the screen prompt:

Switch Console Login:

Password:

Login Name

Enter the console interface factory default console name **admin**.

Password

Enter the factory default password (**ethernav**, press **<Enter>** directly).

Or enter a user-defined password if you followed the instructions later and changed the factory default password.

Factory Default Password: ethernav, press **<Enter>** directly.

NOTE: Only one console and three Telnet users can log on to the switch concurrently. However, it is not recommended that multiple users modify the configuration at the same time.

SWITCH MANAGEMENT SCREEN

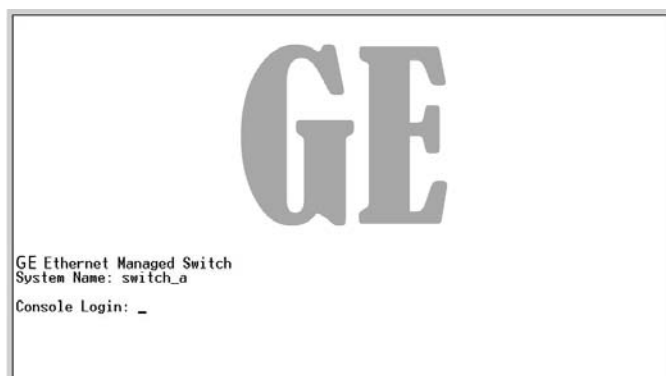

Basic Management

Refer to performing basic management activities.

Advanced Management

Refer to performing advanced management activities.

Logout

Highlight this option and press **<enter>** to log out.

Save Settings

Highlight this option and press **<enter>** to save the current settings and remain in the configuration program.

Restore Default Settings

Highlight this option and press **<enter>** to restore the factory default settings.

Reboot

Highlight this option and press **<enter>** to reboot.

Navigating Through the Console Interface

The console interface consists of a series of menu boxes. Each menu box has several options, which are listed vertically. Move the highlight to select an option as you wish, press the <enter> key to activate that option.

Press this key....	To
Up Arrow or "K"	Move the highlight one line up in a menu box
Down Arrow or "J"	Move the highlight one line down in a menu box
Tab	Move the highlight between screens
Enter	Select the highlighted option
Esc	Move to a previous menu

NOTE: Remember to release the <Caps Lock> key if you press <K> or <J> and cannot move the highlight on the screen.

PERFORMING BASIC MANAGEMENT ACTIVITIES

Basic management activities consist of General, LAN Port, and Console Port tasks.

To Perform Basic Management Activities

Step 1: Highlight **[Basic Management]** from **[Switch Management]** screen and press <enter>. The **[Basic Management]** screens appears:



Step 2:

Highlight a desired option and press **<enter>**. Or press **<esc>** to **EXIT**.

NOTE: The changes will be effective after you press the **<esc>**, but will not be saved until you select the **Save Setting** function.

GENERAL MANAGEMENT CONFIGURATIONS

Step 1:

Highlight **General** from **[Basic Management]** screen and press **<enter>**.

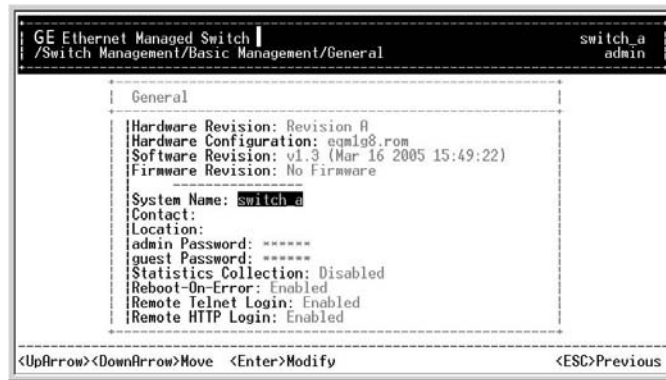

**Step 2: System Name**

System Name is highlighted. Press **<enter>** if you want to change it.

Step 3: Location

Move to highlight **Location** and press **<enter>** if you want to change it.

Step 4: admin Password

Move to highlight **Admin Password** and press **<enter>** If you want to change it.

Step 5: guest Password

Move to highlight **guest Password** and press **<enter>** if you want to change it.

Step 6: Statistics Collection

Move to highlight **Statistics Collection** and press **<enter>** If you want to change it, Disabled or Enabled.

Step 7: Reboot-on-Error

Move to highlight **Reboot-On-Error** and press **<enter>** If you want to change it, Disabled or Enabled.

Step 8: Remote Telnet Login

Move to highlight **Remote Telnet Login** and press **<enter>** if you want to change it, Disabled or Enabled.

Step 9: Remote HTTP Login

Move to highlight **Remote Http Login** and press **<enter>** if you want to change it, Disabled or Enabled.

Step 10:

Press **<esc>** to return to **[Basic Management]** screen when complete.

LAN Port Configurations

Step 1:

Highlight **LAN Port** from **[Basic Management]** screen, and press **<enter>**.



Step 2: Speed & Flow Control

Speed & Flow Control is highlighted. Press **<enter>** if you want to set speed or flow control on port.

Step 3:

Highlight **All Ports** and press **<enter>** to configure at one time.

Or move to highlight each port and press **<enter>** to configure individually.

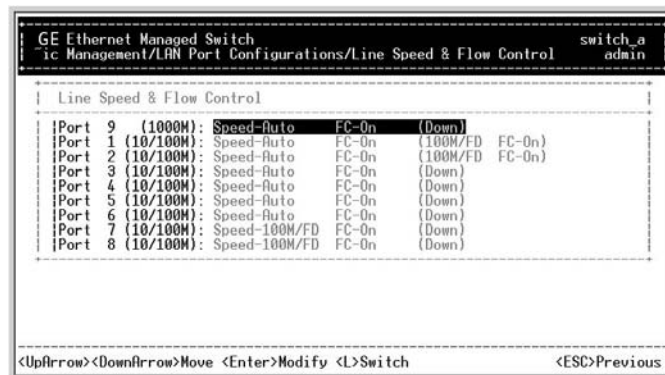

Step 4:

Port Setting Options screen appears. Highlight **Speed & Flow Control**, and press **<enter>**.

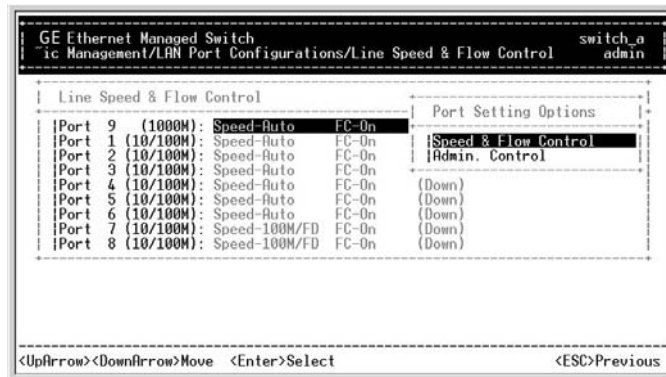

Step 5: Line Speed

For **Line Speed**, move to highlight a desired setting from **Speed Options**, and press **<enter>**.

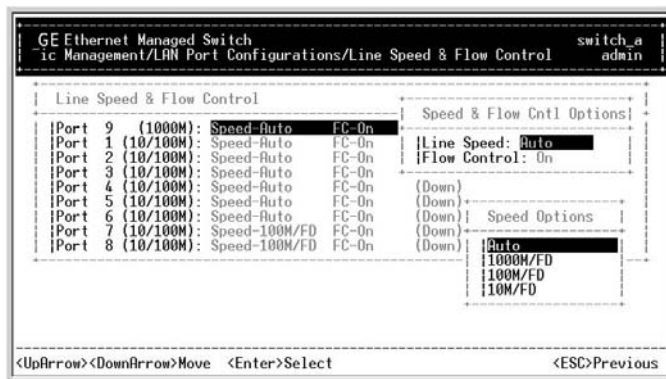

Note: In the Speed Options, HD denotes half-duplex and FD denotes full-duplex.

Step 6:

Press **<esc>** to previous screen. Highlight **Flow Control**, and press **<enter>**.

Step 7: Flow Control

For **Flow Control**, move to highlight a desired setting from **Flow Cntl Options**, and press **<enter>**.

Console Port Configurations

Step 1:

Move to highlight **Console Port** from **[Basic Management]** screen.

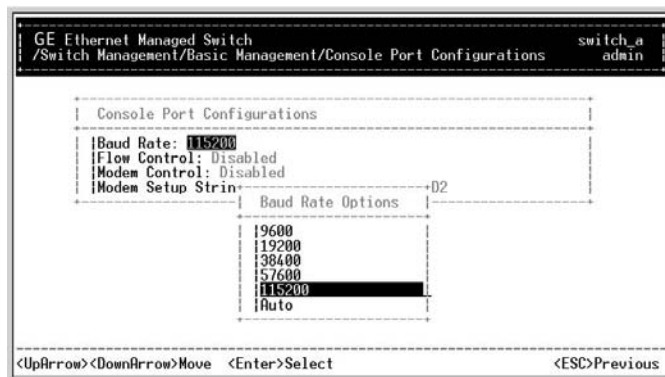

Step 2: Baud Rate

Baud Rate is highlighted. Press **<enter>** if you want to change the current console baud rate.

Step 3: Flow Control

Press **<esc>** to return to **[Basic Management]** screen when completed.

Step 4: Modem Control

Step 5: Modem Setup String

Not Supported.

Step 6: Return to Basic Management

Press **<esc>** to return to **[Basic Management]** screen when completed.

Alarm Configurations

Step 1:

Move to highlight **Alarm** from **[Basic Management]** screen.



Step 2:

Set optical ports Loss of Signal.



Step 3:

Highlight desired function.



PERFORMING ADVANCED MANAGEMENT ACTIVITIES

Advanced management activities consist of L2 Switching Database/ IP Networking/ Bridging/ Static Filtering/ Spanning Tree/ SNMP/ Other Protocols/ Port Trunking/ Port Mirroring/ File Transfer.

To Perform Advanced Management Activities

Step 1:

Highlight **[Advanced Management]** from **Switch Management** screen, and press **<enter>**. The **[Advanced Management]** screen appears:



Step 2:

Move to highlight a desired option and press **<enter>**. Or press **<esc>** to exit.

L2 Switching DataBase

View and change VLAN, MAC address, IP multicast group, and port perspectives.

IP Networking

View and change IP settings and ping settings.

Bridging

View and change aging period for MAC address and flood limit for all ports.

Static Filtering

View/add/delete/search all source/destination MAC addresses to be filtered.

Rapid Spanning Tree

View and change spanning tree configurations, ports states, path costs, and port priorities.

SNMP

View and change the SNMP configuration.

Port Mirroring

Mirror one port to Port 1.

Other Protocols

View and change GVRP and IGMP settings.

QoS Set Up

Link Aggregation

Assign a range of ports to trunking groups.

File Transfer

Send files using the TFTP or Kermit protocol.

L2 Switching DataBase

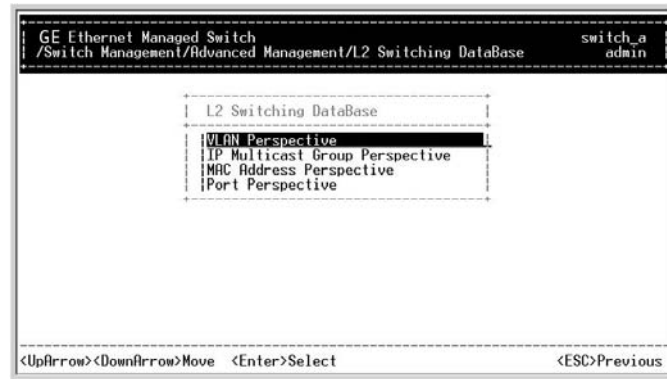
**Step 1: VLAN Perspective**

Highlight **L2 Switching Database** from **[Advanced Management]** screen, and press **<enter>**.

Step 2:

The **VLAN Perspective** is highlighted. Press **<enter>** to view VLAN info of the default VLAN or if you want to obtain a VLAN perspective instead of the default VLAN.

Note: Default VLAN:

The IEEE802.1Q standard defines VLAN ID #1 as the default VLAN.

The default VLAN includes all the ports as the factory default.

**Step 3: Create VLAN**

Press **<+>** on keypad to enter **New VLAN Settings**.

Enter new VLAN ID and VLAN name.

Note: *"Remote" is appended to the VLAN ID automatically if the VLAN is learned from a remote switch.*

Step 4:

Press **<esc>** and the following screen appears. Press **<+>** to add new switch ports to the newly created VLAN.

**Step 5:**

Move to highlight a suitable option from **Port Options** and press **<enter>**, e.g. Untagged Ports.

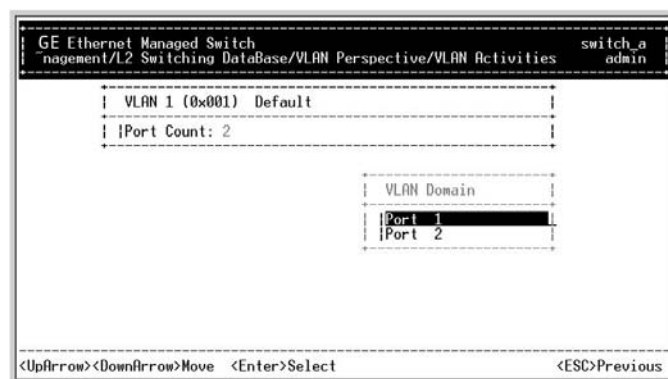
**Step 6:**

From **Select Untagged Ports**, press **<enter>** to select **All Ports** or move to highlight each port individually and press **<enter>**. Similar procedure when you select Tagged Ports and Forbidden Ports in **Step 5**.

Note: *If you added untagged ports and want to now add tagged ports or forbidden ports, or vice versa, repeat Step 5 and Step 6.*

Step 7:

Press <esc> to a previous screen as shown in **Step 2**.

Step 8: Delete VLAN

Highlight a **VLAN ID** and press <-> to delete it.

Note: The default VLAN cannot be deleted.

IP Multicast Group Perspective

Step 1:

Move to highlight **IP Multicast Group Perspective** from **L2 Switching Database** screen, and press <enter>.

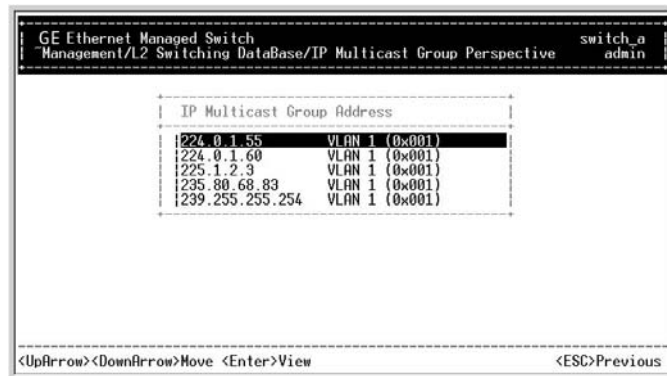

Step 2:

Move to highlight an address to view information associated with this IP multicast group.

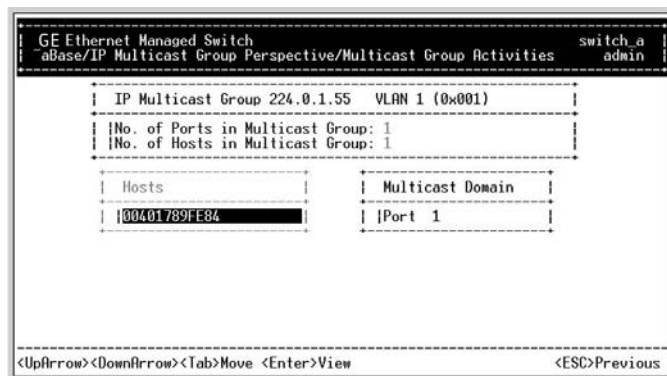

MAC Address Perspective

Step 1:

Move to highlight **MAC Address Perspective** from **L2 Switching Database** screen, and press **<enter>**.



Step 2:

Enter a MAC address to view characteristics information, corresponding VLAN's, and corresponding ports in the switching database.

Port Perspective

Step 1:

Move to highlight **Port Perspective** from **L2 Switching Database** screen, and press **<enter>**. You can view VLAN activities and RMON statistics here.



Step 2: Per Port VLAN Activities

Per Port VLAN Activities is highlighted. Press <enter>.

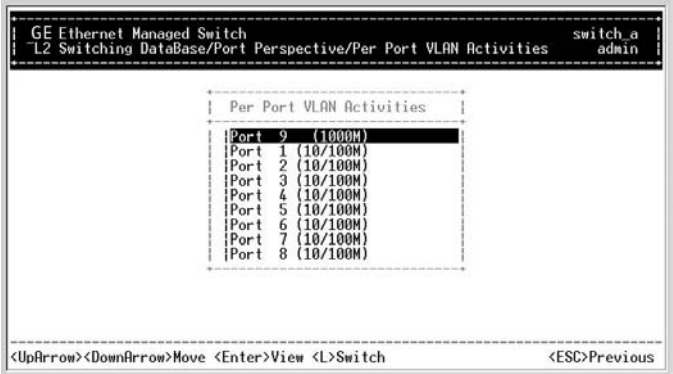

Step 3:

Move to highlight a port and press <enter>. Example: select Port 1 to view corresponding VLAN Activities.

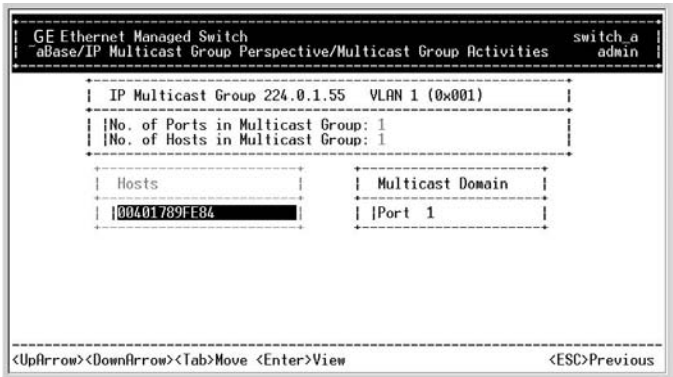

Step 4:

View or search by MAC address individually.

Step 5:

Press <esc> to return to a previous screen as shown in Step 1.

Step 6: Per Port Statistics

Move to highlight **Per Port Statistics** and press **<enter>**.

```

GE Ethernet Managed Switch                               switch_a
men/L2 Switching DataBase/Port Perspective/Per Port Statistics  admin

|-----|
| Per Port Statistics |
|-----|
|Port 9 (1000M)      |
|Port 1 (10/100M)   |
|Port 2 (10/100M)   |
|Port 3 (10/100M)   |
|Port 4 (10/100M)   |
|Port 5 (10/100M)   |
|Port 6 (10/100M)   |
|Port 7 (10/100M)   |
|Port 8 (10/100M)   |
|-----|

<UpArrow><DownArrow>Move <Enter>View <R>Reset Counters <L>Switch <ESC>Previous

```

Step 7:

Move to highlight a port and press **<enter>**. Example: select **Port 1** to view corresponding VLAN Activities. Press **[R]** to reset counter for this port.

```

GE Ethernet Managed Switch                               switch_a
Switching DataBase/Port Perspective/Per Port Statistics/Port 1  admin

|-----|
| Port 1 Statistics |
|-----|
|Total No. of Bytes Received: 0|
|Total No. of Packets Received: 0|
|Total No. of Broadcast Packets Received: 0|
|Total No. of CRC/Alignment Errors Received: 0|
|Total No. of Undersize Packets Received: 0|
|Total No. of Oversize Packets Received: 0|
|Total No. of Collisions: 0|
|Total No. of 64-byte Packets Received: 0|
|Total No. of 65 to 127-byte Packets Received: 0|
|Total No. of 128 to 255-byte Packets Received: 0|
|Total No. of 256 to 511-byte Packets Received: 0|
|Total No. of 512 to 1023-byte Packets Received: 0|
|Total No. of 1.0 to 1.5-kbyte Packets Received: 0|
|Total No. of Bytes Transmitted: 0|
|-----|

<UpArrow><DownArrow>Move <R>Reset Counters                               L>Switch <ESC>Previous

```

Step 8: Per Port MAC Unit

Move to highlight **Per Port Priority** and press **<enter>**.

Step 9:

Move to highlight a port and press **<enter>**. Example: select **Port 1** to view corresponding priority level.

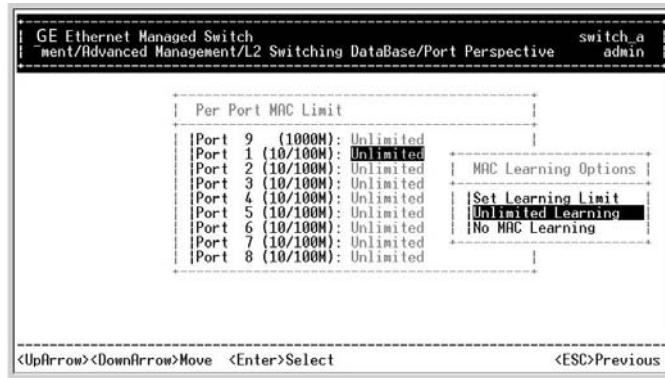

IP Networking

Step 1:

Move to highlight **IP Networking** from **[Advanced Management]** screen, and press **<enter>**.

Step 2: IP & RIP Settings

Highlight **IP & RIP Settings** from **IP Networking**, and press **<enter>**.

```

GE Ethernet Managed Switch                               switch_a
/ Switch Management/Advanced Management/IP Networking   admin
|
| IP Networking
| | IP & RIP Settings
| | ARP Table
| | Routing Table
| | DHCP Gateway Settings
| | IPing
|
|-----|
|<UpArrow><DownArrow>Move |<Enter>Select |<ESC>Previous

```

Step 3:

The screen shows a list of VLAN IDs, IP addresses, subnet masks, proxy ARPs, and RIPs currently defined.

```

GE Ethernet Managed Switch                               switch_a
Management/Advanced Management/IP Networking/IP & RIP Settings   admin
|-----|
| VLAN ID | IP Address | Subnet Mask | Proxy ARP | RIP |
|-----|-----|-----|-----|-----|
| 1 (0x001) | 3.112.130.118 | 255.255.255.0 | Disabled | Disabled |
|-----|-----|-----|-----|-----|
|
|-----|
|<UpArrow><DownArrow>Move |<Enter>View/Modify |<ESC>Previous

```

Step 4:

Move to highlight the row that contains the parameters you want to change, and press **<enter>**.

```

GE Ethernet Managed Switch                               switch_a
Management/Advanced Management/IP Networking/IP & RIP Settings  admin

VLAN 1 (0x001) IP Settings
IP Address: 3.112.130.118
IP Subnet Mask: 255.255.255.0
Frame Type: Ethernet_II
BOOTP: DHCP ENABLED
Proxy ARP: Disabled
RIP Setting: Disabled
Broadcast with RIP V1 Compatible:
Advertise Routes:
Advertise Default Route:
Accept RIP V1/V2 Updates:
Accept Default Route Updates:
Use Split Horizon:
Use Poisoned Reverse:
Send Triggered Responses:

<UpArrow><DownArrow>Move <Enter>Modify <->Delete          <ESC>Previous
    
```

ARP Table

Step 1:

Highlight **ARP Table** from **IP Networking**, and press **<enter>**.

```

GE Ethernet Managed Switch                               switch_a
/Switch Management/Advanced Management/IP Networking/ARP Table  admin

Internet Address  Physical Address  VLAN ID  Type
-----
3.112.8.101       000CCF6569E0    1 (0x001)  dynamic

<UpArrow><DownArrow>Move <->Add <->Delete <s>Search      <ESC>Previous
    
```

Routing Table

Step 1:

Highlight **Routing Table** from **IP Networking**, and press **<enter>**.

```

GE Ethernet Managed Switch                               switch_a
Switch Management/Advanced Management/IP Networking/Routing Table  admin

Network      Mask      Gateway      Metric VLAN  Type Protocol
-----
0.0.0.0      255.0.0.0  0.0.0.0      1      1      Martian Local
3.112.130.0  255.255.255.0  3.112.130.118  1      0x001 Direct Local
3.112.130.0  255.255.255.255  3.112.130.255  1      0x001 Martian Local
3.112.130.118  255.255.255.255  3.112.130.118  1      0x001 Myself Local
3.112.130.255  255.255.255.255  3.112.130.255  1      0x001 Bcast Local
127.0.0.0    255.0.0.0    0.0.0.0      1      1      Martian Local
224.0.0.0    224.0.0.0    0.0.0.0      1      1      Martian Local
224.0.0.0    240.0.0.0    0.0.0.0      1      1      Mcast Local
224.0.0.9    255.255.255.255  0.0.0.0      1      1      Mcast Local
255.255.255.255  255.255.255.255  255.255.255.255  1      1      Bcast Local

<UpArrow><DownArrow>Move <->Add <->Delete <s>Search      <ESC>Previous
    
```

DHCP Gateway

Step 1:

Highlight **DHCP Gateway** from **IP Networking**, and press **<enter>**.

```

GE Ethernet Managed Switch                               switch_a
agement/Advanced Management/IP Networking/DHCP Gateway Settings  admin
-----
| VLAN ID      IP Address  DHCP Gateway  Max Hops  Delay  Servers  Relays |
|-----|-----|-----|-----|-----|-----|-----|
| 1 (0x001)   3.112.130.118  Disabled      4         0      |
|-----|-----|-----|-----|-----|-----|-----|

<UpArrow><DownArrow>Move <Enter>View/Modify                <ESC>Previous

```

Step 2:

Select **VLAN**, and press **<enter>**.

```

GE Ethernet Managed Switch                               switch_a
agement/Advanced Management/IP Networking/DHCP Gateway Settings  admin
-----
| DHCP Gateway Settings |
|-----|
| VLAN ID: 1 (0x001)   |
| IP Address: 3.112.130.118 |
| DHCP Gateway: Disabled |
| Maximum Hops: 4     |
| Delay (sec): 0      |
| Preferred Server:   |
| Preferred Server:   |
| Preferred Server:   |
| Preferred Server:   |
|-----|

<UpArrow><DownArrow>Move <Enter>Modify <+>Add Relay IP <->Del IP <ESC>Previous

```

Step 3:

Highlight **DHCP Gateway** for **Enabling or Disabling** function.

Ping Settings

Step 1:

Move to highlight **Ping** from **IP Networking**, and press **<enter>**.

```

GE Ethernet Managed Switch                               switch_a
/Switch Management/Advanced Management/IP Networking/Ping      admin
-----
| Ping |
|-----|
| Host: ██████████ |
| Count: 1 |
| Size (bytes): 64 |
| Timeout (sec): 1 |
|-----|
| Enter IP Address: |
|-----|

Enter 4 decimal bytes (dot separated) and press <ENTER>                <ESC>Previous

```

Step 2: Host

Move to highlight **Host**, and press **<enter>**.

Step 3:

Enter 4 decimal bytes (dot separated) as the IP address to ping.

Step 4: Count

Move to highlight **Count**, and press **<enter>**.

Step 5:

Specify a packet count number from 1 to 999, or type 0 for an infinite packet count, and press **<enter>**.

Step 6: Size (bytes)

Move to highlight **Size**, and press **<enter>**.

Step 7:

Specify a packet size from 0-1500, and press **<enter>**.

Step 8: Timeout (sec)

Move to highlight **Timeout**, and press **<enter>**.

Step 9:

Specify a timeout value from 1-999, and press **<enter>**.

Step 10:

Press **<esc>** to start to ping when completed with the ping parameters.

Bridging

Step 1:

Move to highlight **Bridging** from **[Advanced Management]** screen, and press **<enter>**.

```

GE Ethernet Managed Switch                               switch_a
/Switch Management/Advanced Management/Bridging Parameters  admin

| Bridging Parameters |
| Aging Time (seconds): 300 |
| Flood Limit for All ports (pkt/s): Unlimited |
| Broadcast Limit (pkt/s): Unlimited |
| Multicast Limit (pkt/s): Unlimited |

<UpArrow><DownArrow>Move <Enter>Modify <ESC>Previous

```

Step 2: Aging Time

Move to highlight **Aging Time**, and press **<enter>**. Enter a decimal number as bridge aging period in seconds or, enter 0 for no aging.

Step 3: Flood Limits for all Ports

Move to highlight **Flood Limit for All Ports**, and press **<enter>**. Enter a decimal number as flood limit in packets per second or, enter 0 for no limit.

Static Filtering

Step 1:

Move to highlight **Static Filtering** from **[Advanced Management]** screen, and press **<enter>**.

```

GE Ethernet Managed Switch                               switch_a
/Switch Management/Advanced Management/Static Filtering      admin

| Static Filtering |
| Source MAC Address Out-Filters |
| Destination MAC Address Out-Filters |
| MAC Address In-Filters |

<UpArrow><DownArrow>Move <Enter>View/Modify <ESC>Previous

```

Step 2: Source/Destination MAC Address Out-Filters

Move to highlight **Source MAC Addresses** or **Destination MAC Addresses** for static filtering, and press **<enter>**.

Source Filter



Destination Filter



MAC Address in Filters

Step 3:

Move to highlight **MAC Address Filters** from **Static Filtering**, and press **<enter>**.

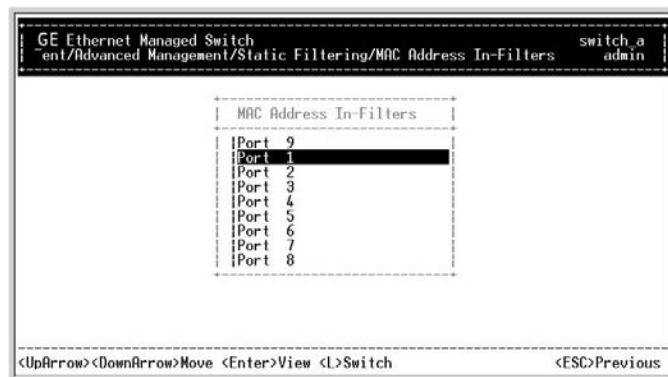

MAC Address in Filters

**Step 4: Add/Delete/Search**

Press **[+]** on keypad to add a specific MAC address to be filtered. Press **[-]** to delete a specific MAC address from being filtered. Press **[S]** to search through current list of MAC addresses in the static filtering database. The static filtering database maximum capacity is 64.

Caution:

- * No precautionary message appears before you delete a specific MAC address from being filtered.
- * Be sure you want to delete it before doing so.

Rapid Spanning Tree Functions

Step 1:

Move to highlight **Rapid Spanning Tree** from **[Advanced Management]** screen, and press **<enter>**.

```

GE Ethernet Managed Switch                               switch_a
tch Management/Advanced Management/Rapid Spanning Tree Protocol  admin

Rapid Spanning Tree Protocol
Spanning Tree Configurations
Spanning Tree Port States
Spanning Tree Path Costs
Spanning Tree Port Priorities
Protocol Migration
Edge Port
Point To Point Link

<UpArrow><DownArrow>Move  <Enter>Select                <ESC>Previous

```

Step 2: Spanning Tree Configurations

Move to highlight **Spanning Tree Configurations** if you want to change Spanning Tree Protocol Configurations.

```

GE Ethernet Managed Switch                               switch_a
id Spanning Tree Protocol/Spanning Tree Protocol Configurations  admin

Spanning Tree Protocol Configurations
Bridge ID: 8000:00B019A0B114
Designated Root: 2001:000CCE4DB0C0
Root Port: Port 1
Root Path Cost: 200,019
Current Max Age (sec): 20
Current Hello Time (sec): 2
Current Forward Delay (sec): 15
Hold Time (sec): 1
Topology Change Count: 51
Time Since Last Topology Change (sec): 660

Spanning Tree Protocol: Enabled
Bridge Priority: 32,768
Hello Time (sec): 2

<UpArrow><DownArrow>Move  <Enter>Modify <L>Switch      <ESC>Previous

```

Step 3: Spanning Tree Protocol

Press **<enter>** to enter **Spanning Tree Options**. Decide to have it Disabled or Enabled.

Step 4: Bridge Priority

Move to highlight **Bridge Priority**, and press **<enter>**. Type a decimal number for the bridge priority and press **<enter>**.

Step 5: Hello Time (sec)

Move to highlight **Hello Time**, and press **<enter>**. Type a decimal number for the hello time, and press **<enter>**.

Step 6: Max Age (sec)

Move to highlight **Max Age**, and press **<enter>**. Type a decimal number for the max age.

Step 7: Forward Delay (sec)

Move to highlight **Forward Delay**, and press **<enter>**. Type a decimal number for the forward delay.

Spanning Tree Port States

Step 1:

Move to highlight **Spanning Tree Port States** if you want to change per port administration status, and press **<enter>**.

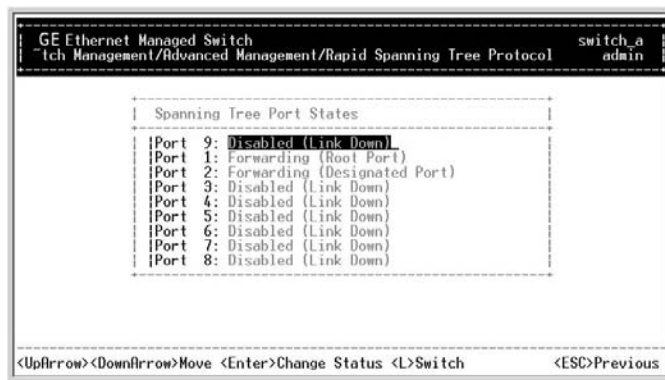

Step 2:

Move to highlight a port if you want to change its administration status, and press **<enter>**. **Disabled (Link Down)** denotes Admin Status Up without a link. **Forwarding** denotes **Admin Status Up** with a link. **Admin Status Down** denotes no TX/RX transmission allowed. **Admin Status Up** denotes TX/RX transmission allowed.

Spanning Tree Path Costs

Step 1:

Move to highlight **Spanning Tree Path Costs** if you want to change the path cost, and press **<enter>**.

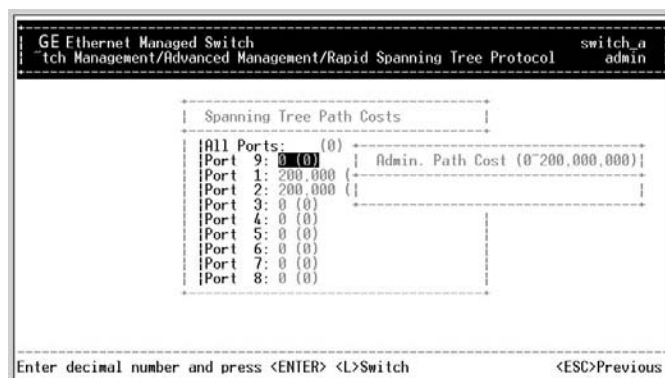

Spanning Tree Port Priorities

Step 1:

Move to highlight **Spanning Tree Port Priorities** if you want to change the priority level per port, and press **<enter>**.

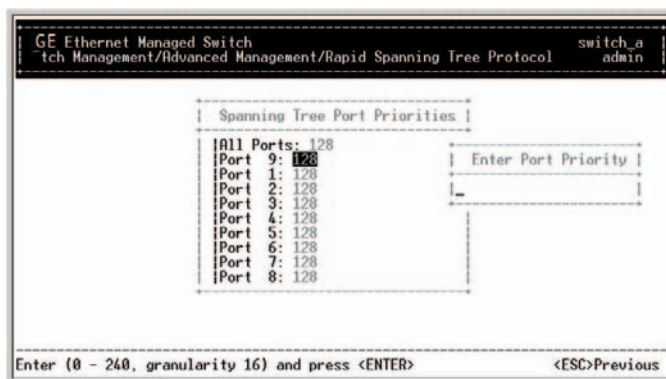

Step 2:

Move to highlight **All Ports** or each port individually, and press **<enter>**. For new priority value, type a decimal number from 0-255, and press **<enter>**. A low value gives the port a greater likelihood of becoming a Root port.

Protocol Migration

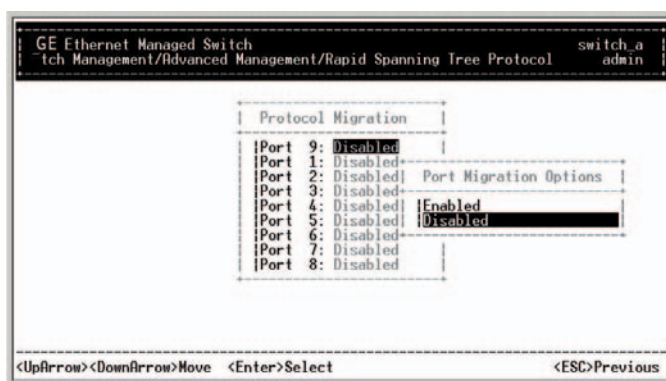

Edge Port

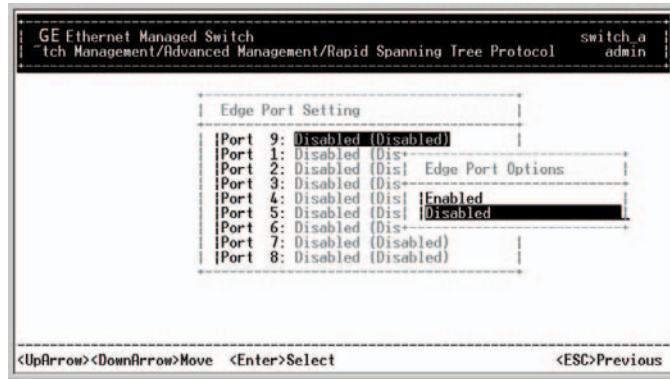

Point-to-Point Link

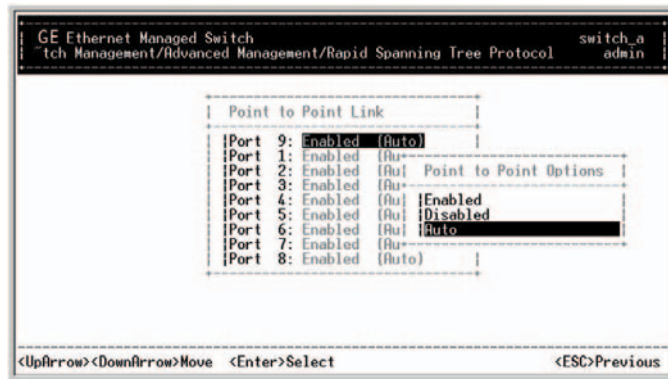

SNMP Functions

Step 1:

Move to highlight **SNMP** from **[Advanced Management]** screen, and press **<enter>**.

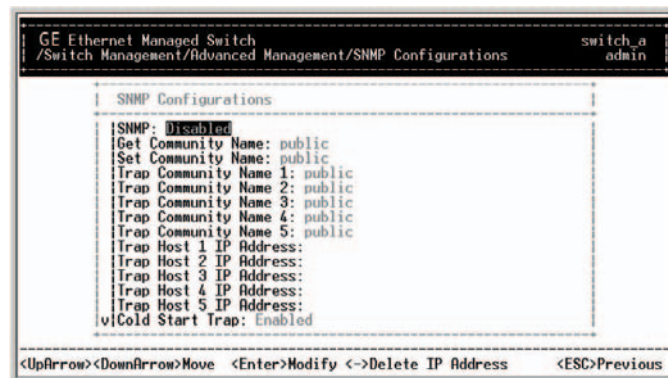

Step 2: SNMP Options

Move to highlight **SNMP**, and press **<enter>**. Decide to have it Disabled or Enabled.

Step 3: Get Community Name

Move to highlight **Get Community Name**, and press **<enter>**.
Enter text and press **<enter>**.

Step 4: Set Community Name

Move to highlight **Set Community Name**, and press **<enter>**. Enter text and press **<enter>**.

Step 5: Trap Community Name

Move to highlight **Trap Community Name 1** and press **<enter>**. Enter text and press **<enter>**.
Repeat to specify up to three more trap community names.

Step 6: Trap Host IP Address

Move to highlight **Trap Host 1 IP Address**, and press **<enter>**. Type an IP address for trap host 1 and press **<enter>**. Repeat to specify up to two more trap host IP addresses.

Step 7: Cold Start Trap

Move to highlight **Cold Start Trap**, and press **<enter>**. Decide to have it Disabled or Enabled.

Step 8: Warm Start Trap

Move to highlight **Warm Start Trap**, and press **<enter>**. Decide to have it Disabled or Enabled.

Step 9: Link Down Trap

Move to highlight **Link Down Trap**, and press **<enter>**. Decide to have it Disabled or Enabled.

Step 10: Link Up Trap

Move to highlight **Link Up Trap**, and press **<enter>**. Decide to have it Disabled or Enabled.

Step 11: Authentication Failure Trap

Move to highlight **Authentication Failure Trap**, and press **<enter>**.
Decide to have it Disabled or Enabled.

Step 12: Rising Alarm Trap

Move to highlight **Rising Alarm Trap**, and press **<enter>**.
Decide to have it Disabled or Enabled.

Step 13: Falling Alarm Trap

Move to highlight **Falling Alarm Trap**, and press **<enter>**.
Decide to have it Disabled or Enabled.

Step 14: Topology Change Trap

Move to highlight **Topology Change Trap**, and press **<enter>**.
Decide to have it Disabled or Enabled.

Other Protocols

Step 1:

Move to highlight **Other Protocols** from **[Advanced Management]** screen, and press **<enter>**.

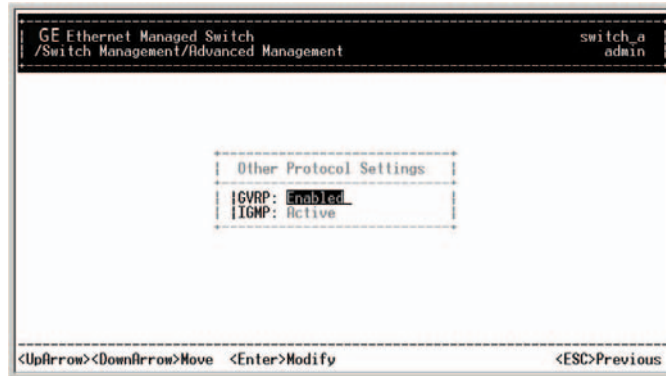

Step 2: GVRP

Move to highlight **GVRP**, and press **<enter>**. Decide to have it Disabled or Enabled.

Step 3: IGMP

Move to highlight **IGMP**, and press **<enter>**. Decide to have it Disabled or set in either Passive or Active mode.

Link Aggregation

Step 1:

Move to highlight **Link Aggregation** from **[Advanced Management]** screen, and press **<enter>**.

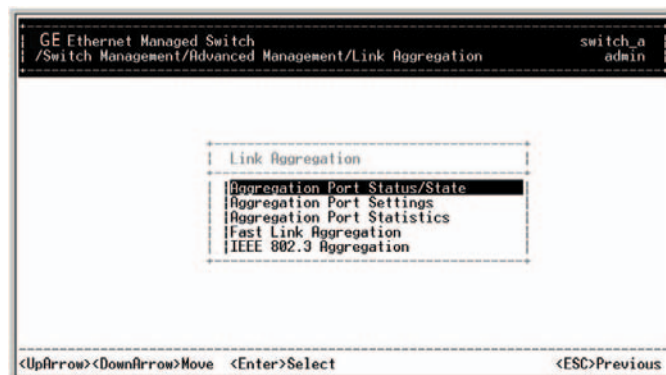

Aggregation Port Status

Step 2:

Move to highlight **Aggregation Port Status**, and press <enter>.

```

GE Ethernet Managed Switch                               switch_a
Advanced Management/Link Aggregation/Aggregation Port Status/State  admin

Aggregation Port Status/State
-----
Port 1 (10/100M)   Status: Selected   Lag: 10
Port 2 (10/100M)   Status: Unselected  Lag: 11
Port 3 (10/100M)   Status: Unselected  Lag: 0
Port 4 (10/100M)   Status: Unselected  Lag: 0
Port 5 (10/100M)   Status: Unselected  Lag: 0
Port 6 (10/100M)   Status: Unselected  Lag: 0
Port 7 (10/100M)   Status: Unselected  Lag: 0
Port 8 (10/100M)   Status: Unselected  Lag: 0
Port 9 (1000M)     Status: Unselected  Lag: 0

<UpArrow><DownArrow>Move  <Enter>View <L>Switch          <ESC>Previous
    
```

Step 3:

Select **Actor** or **Partner** for the Port selected.

```

GE Ethernet Managed Switch                               switch_a
Advanced Management/Link Aggregation/Aggregation Port Status/State/Port 1  admin

Port 1
-----
Actor
Partner

<UpArrow><DownArrow>Move  <Enter>Select          <ESC>Previous
    
```

Actor Screen

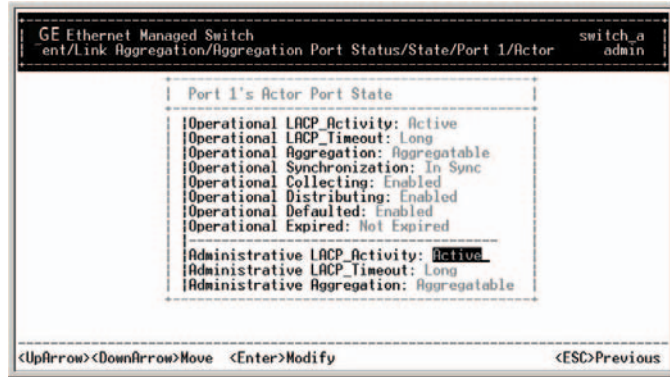

Partner Screen



Aggregation Port Settings

Step 4:

Move to highlight **Aggregation Port Settings**, and press <enter>.

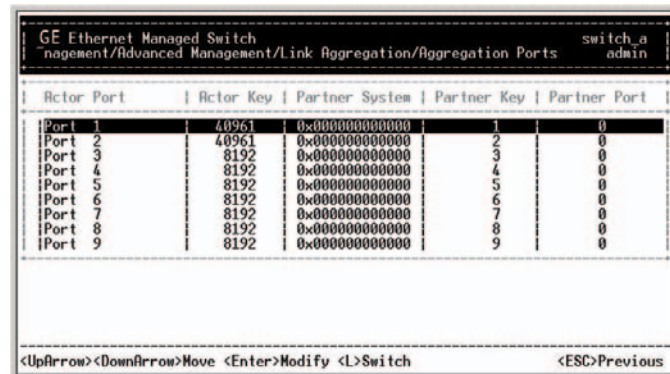

Aggregation Port Settings

Step 5:

Select desired Port.

```

GE Ethernet Managed Switch                               switch_a
Advanced Management/Link Aggregation/Aggregation Ports  admin

Aggregation Port 1 Configurations
-----
|Actor Operational System Priority: 0
|Actor Operational System Id: 0x006019A0B114
|Actor Operational Key: 40961
|Actor Operational Port Priority: 1
|Actor Operational Port Id: 1
|Partner Operational System Priority: 0
|Partner Operational System Id: 0x000000000000
|Partner Operational Key: 1
|Partner Operational Port Priority: 0
|Partner Operational Port Id: 0
-----
|Actor Administrative Key: 40961
|Partner Administrative System Priority: 0
|Partner Administrative System Id: 0x000000000000
-----
<UpArrow><DownArrow>Move <Enter>Modify <R>Restore Defaults <ESC>Previous
    
```

Aggregation Port Statistics

Step 6:

Move to highlight **Aggregation Port Statistics**, and press <enter>.

```

GE Ethernet Managed Switch                               switch_a
Advanced Management/Link Aggregation/Aggregation Port Statistics  admin

Aggregation Port Statistics
-----
|Port 1 (10/100M)
|Port 2 (10/100M)
|Port 3 (10/100M)
|Port 4 (10/100M)
|Port 5 (10/100M)
|Port 6 (10/100M)
|Port 7 (10/100M)
|Port 8 (10/100M)
|Port 9 (1000M)
-----
<UpArrow><DownArrow>Move <Enter>View <L>Switch <ESC>Previous
    
```

Step 7:

Select desired Port.

```

GE Ethernet Managed Switch                               switch_a
Advanced Management/Link Aggregation/Aggregation Port Statistics  admin

Aggregation Port 1 Statistics
-----
|LACPDU's Received: 0
|Marker PDU's Received: 0
|Marker Response PDU's Received: 0
|Unknown Packets Received: 0
|Illegal Packets Received: 0
|LACPDU's Transmitted: 3812
|Marker PDU's Transmitted: 0
|Marker Response PDU's Transmitted: 0
-----
<UpArrow><DownArrow>Move <ESC>Previous
    
```

Fast Link Aggregation

Step 8:

Move to highlight **Fast Link Aggregation**, and press <enter>.

```

GE Ethernet Managed Switch                               switch_a
ment/Advanced Management/Link Aggregation/Fast Link Aggregation  admin

Key | Member Ports |
|-----|-----|
| | |

<UpArrow><DownArrow>Move <+>Add <->Delete <Enter>Detail          <ESC>Previous
    
```

IEEE802.3 Aggregation

Step 9:

Move to highlight **IEEE802.3 Aggregation**, and press <enter>.

```

GE Ethernet Managed Switch                               switch_a
ch Management/Advanced Management/Link Aggregation/Aggregators  admin

Aggregator | Actor Key | Partner System | Partner Key | Status |
|-----|-----|-----|-----|-----|
10          | 40961    | 0x000000000000 | 1           | Individual |
11          | 40961    | 0x000000000000 | 2           | Individual |
12          | 0        | 0x000000000000 | 0           | Empty      |
13          | 0        | 0x000000000000 | 0           | Empty      |
14          | 0        | 0x000000000000 | 0           | Empty      |
15          | 0        | 0x000000000000 | 0           | Empty      |
16          | 0        | 0x000000000000 | 0           | Empty      |
17          | 0        | 0x000000000000 | 0           | Empty      |
18          | 0        | 0x000000000000 | 0           | Empty      |

<UpArrow><DownArrow>Move <Enter>Select          <ESC>Previous
    
```

Step 10:

Select desired Aggregator.

```

GE Ethernet Managed Switch                               switch_a
ch Management/Advanced Management/Link Aggregation/Aggregators  admin

Aggregator 10 Details
|-----|
|Aggregator MAC Address: 0x000019A0B114|
|Actor System Priority: 0|
|Actor System ID: 0x00B019A0B114|
|Actor Key: 0|
|Partner System Priority: 0|
|Partner System ID: 0x000000000000|
|Partner Key: 1|
|Aggregator Status: Individual|
|Actor Key Type: Default|
|-----|

<UpArrow><DownArrow>Move <Enter>Port List          <ESC>Previous
    
```

Port Mirroring

Step 1:

Move to highlight **Port Mirroring** from **[Advanced Management]** screen, and press **<enter>**. You can mirror one port to Port 1.

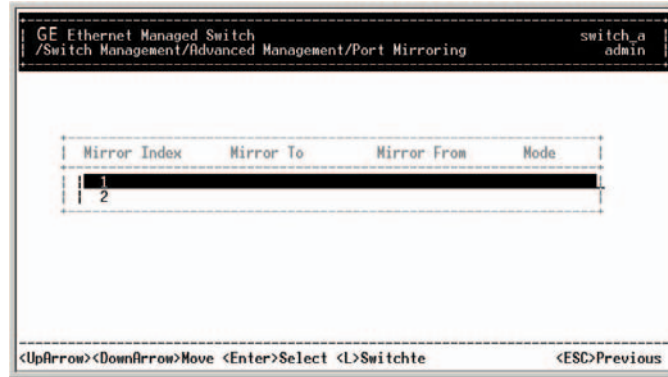

Step 2:

Press **<enter>** to enter **Port Mirroring Options**.

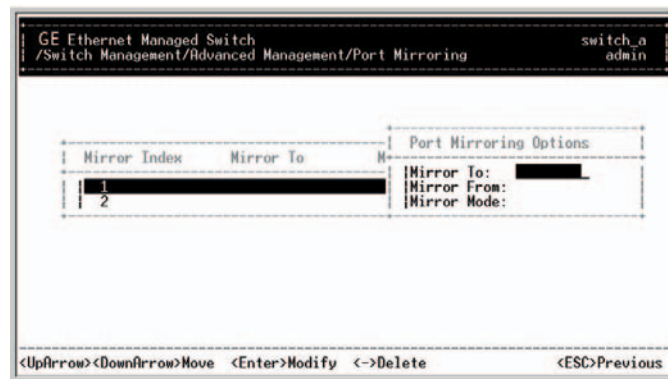

Step 3: Mirror From

Press **<enter>** to enter **Mirror From Options**, listing the ports that can be mirrored from.

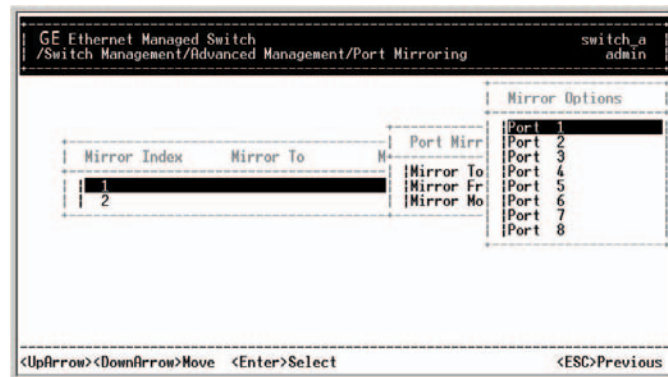

Step 4:

Move to highlight the port you want to mirror from and press **<enter>**.

Step 5: Mirror Mode

Move to select **Mirror Mode**. From **Mode Options**, decide whether the port to be mirrored from will be receiving or transmitting.

Step 6:

Press **<esc>** when completed.

Quality of Service (QoS)**Step 1:**

Move to highlight **QoS Setup** from **[Advanced Management]** screen, and press **<enter>**.

```

GE Ethernet Managed Switch                               switch_a
/Switch Management/Advanced Management/QoS Setup        admin

|-----|
| QoS Setup                                             |
| Global Setting                                         |
| Logical Port                                           |
| VLAN                                                  |
| ToS                                                   |
| Tx Queue Setting                                       |
| Fixed Priority                                         |
| Rate Control                                           |
|-----|

<UpArrow><DownArrow>Move  <Enter>Select                <ESC>Previous

```

Global Setting**Step 2:**

Move to highlight **Global Setting**, and press **<enter>**.

```

GE Ethernet Managed Switch                               switch_a
/Switch Management/Advanced Management/QoS Setup/Global Setting  admin

|-----|
| Global Setting                                         |
|-----|
| QoS Status: Enabled                                   |
| DiffServ Expedite Forwarding: Enabled                 |
| ToS/VLAN Tag Preference: VLAN Tag                    |
| ToS for Xmit: From Bit[4:2] of ToS                    |
| ToS for Drop: From Bit[4:2] of ToS                    |
| WRED Drop Priority Setting...                          |
|-----|

<UpArrow><DownArrow>Move  <Enter>Modify                <ESC>Previous

```

Logical Port

Step 3:

Move to highlight **Logical Port**, and press **<enter>**.



Step 4:

Move to highlight User Defined Port.



Step 5:

Select Port to be Defined.

Step 6:

Move to highlight Well-Known Port.

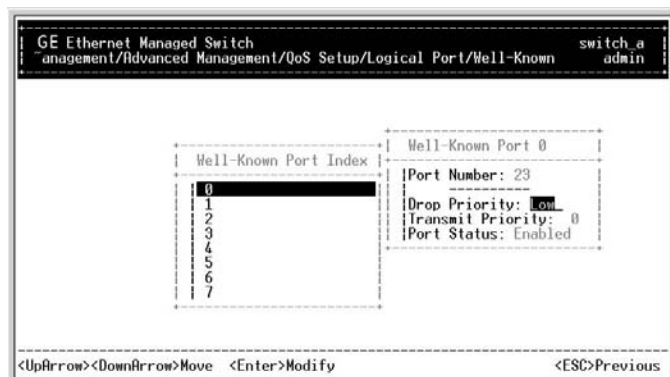

Step 7:

Select Port to be Defined.

Step 8: Move to highlight Range Port.



VLAN

Step 1: Move to highlight VLAN from QoS Setup, and press <enter>.

Step 2: Assign desired port to a VLAN.

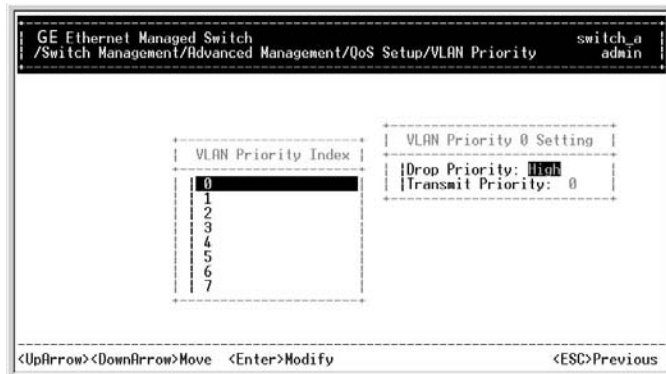

ToS

Step 1: Move to highlight ToS from QoS Setup, and press <enter>.

Step 2: Highlight desired port to be set.



Tx Queue Setting

Step 1: Move to highlight **Tx Queue Setting** from **QoS Setup**, and press **<enter>**.

Step 2: Set Queue for optional Port 9.

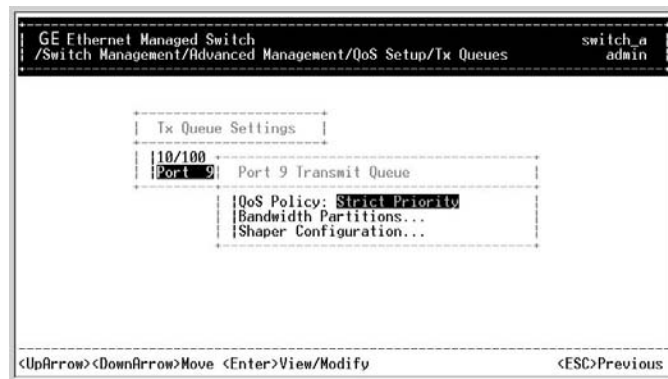

Fixed Priority

Step 1: Move to highlight **Fixed Priority** from **QoS Setup**, and press **<enter>**.

Step 2: Select desired Port.



Rate Control

Step 1: Move to highlight **Rate Control** from **QoS Setup**, and press **<enter>**.



SENDING AND RECEIVING FILES

The TFTP protocol is used to download upgraded software to the switch.

A VLAN with the proper IP address and routing path to the TFTP server must be configured for the switch to access the specified TFTP server.

Step 1:

Move to highlight **File Transfer** from [Advanced Management] screen, and press **<enter>**.

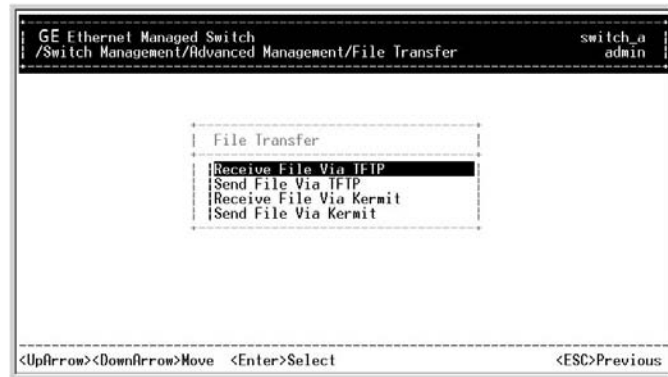

Step 2: Receive File Via TFTP

Move to highlight **Receive File Via TFTP** and press **<enter>**.



Step 3:

If the default **File Name** is not the one you intend to receive, press **<enter>**.
Type the name of the file you intend to receive and press **<enter>**.

Step 4:

Move to highlight **IP Address** and press **<enter>**.
Type the IP address from where the file will be obtained.

Step 5:

Press **<esc>** when completed.

Step 6:

A dialog box appears to ask if you want to transfer file now. Highlight **[Yes]** and press **<enter>** to start file transfer, or move to highlight **[No]** and press **<enter>** to deny it. Press **<esc>** to exit.

Step 7: Send File Via TFTP

Move to highlight **Send File Via TFTP**, and press **<enter>**.

**Step 8:**

If the default **File Type** is not the one you intend to send, press **<enter>**. Select the file type you intend to send and press **<enter>**.

**Step 9:**

Repeat **Step 4-6**.

Logout

To log out, highlight **Logout** from **[Switch Management]** screen, and press **<enter>**. Please remember to save settings you have changed before you log out.

Save Settings

To save the current settings and remain in the configuration program, highlight **Save Settings** from **[Switch Management]**, and press **<enter>**.

Restore Default Settings

To restore the factory default settings, highlight **Restore Default Settings** from **[Switch Management]**, and press **<enter>**.

The switch will be rebooted after confirming **<Yes>** as to restore the default settings.

Reboot

To reboot the switch, highlight **Reboot** from **[Switch Management]**, and press **<enter>**.

WEB-BASED BROWSER MANAGEMENT

The EtherNav™ D7600 switch provides a web-based browser interface for configuring and managing the switch. This interface allows you to access the switch using a preferred web browser.

This section describes how to configure the switch using its web-based browser interface.

LOGGING ON TO THE SWITCH

Switch IP Address

In your web browser, specify the IP address of the switch.

Login ID

Enter the factory default login ID: admin.

Password

Enter the factory default password (**ethernav**, click **<Login>**).

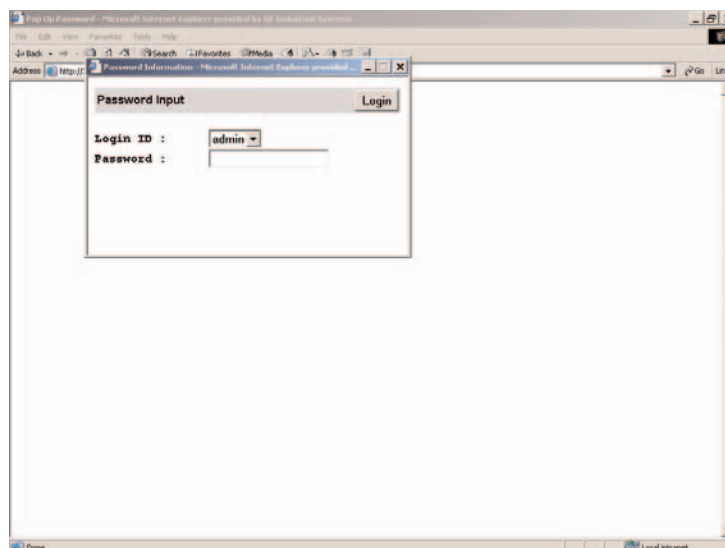

UNDERSTANDING THE BROWSER INTERFACE

The web browser interface provides three point-and-click buttons at the upper field of the screen for configuring and managing the D-GES7600.

The **Basic Setup/General** parameters appear at the lower field of the screen. These parameters can also be displayed by clicking **Basic Setup** button and select **General** in sub-menu.

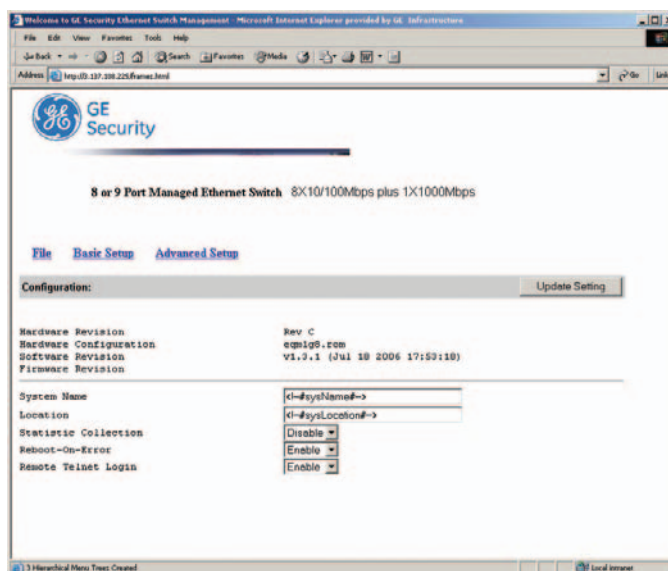

File

Save settings configured in the browser interface / download upgraded software via TFTP / reboot the switch / logout of the browser interface.

Basic Setup

Perform general, LAN port, and console port activities.

Advanced Setup

Perform MAC address management / IP networking / per port statistics / port priority / bridging / static MAC filters / IP multicast group / VLAN perspective / spanning tree perspective / SNMP / other protocols / port trunking / port mirroring.

PERFORMING FILE ACTIVITIES

To Perform File Activities:

Click the [File] button at the upper field of the main display, the menu options appear.

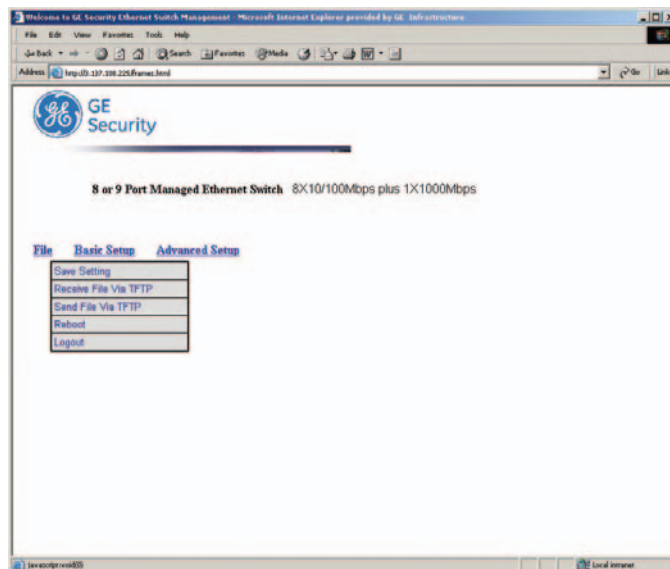

Step 1: Saving Setting

Click **Saving Setting** to save your configuration settings.

Step 2:

When you click it, a message asks "**Are you sure you want to save setting?**", click **OK** to save it or **Cancel** to abort it.

Step 1: Receive File Via TFTP

Click **Receive File Via TFTP** on the [File] display.

Note: The TFTP protocol is used to download upgraded software to the switch. A VLAN with the proper IP address and routing path to the TFTP server must be configured for the switch to access the specified TFTP server.

Step 2:

For **File Name**, type the name of the file you intend to receive.

Step 3:

For **IP Address**, type the IP address from where the file will be obtained.

Step 4:

Click **Receive Now**.

Step 1: Reboot

Click **Reboot** on the **[File]** display.

Step 2:

When you click it, a message asks "**Are you sure you want to save setting?**", click **OK** to save it or **Cancel** to abort it.

Step 1: Logout

Click **Logout** on the **[File]** display.

Step 2:

When you click it, a message asks "**Are you sure you want to save setting?**", click **OK** to save it or **Cancel** to abort it.

PERFORMING BASIC SETUP ACTIVITIES

To perform Basic Setup Activities:

Click the **[Basic Setup]** button at the upper field of the main display, the menu options appear.

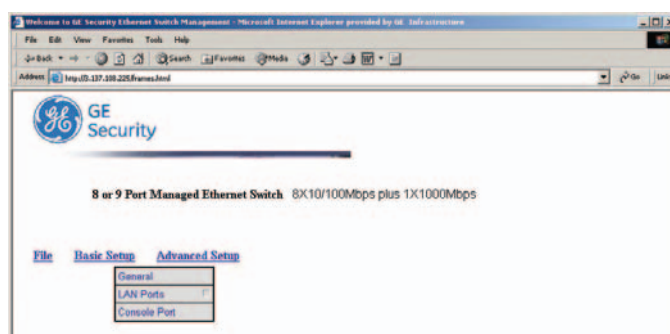
**Step 1: General Management Configuration**

Click **General** and the screen shows' the Basic Setup/General parameters.

The screen here is the same when you first access the switch browser interface.

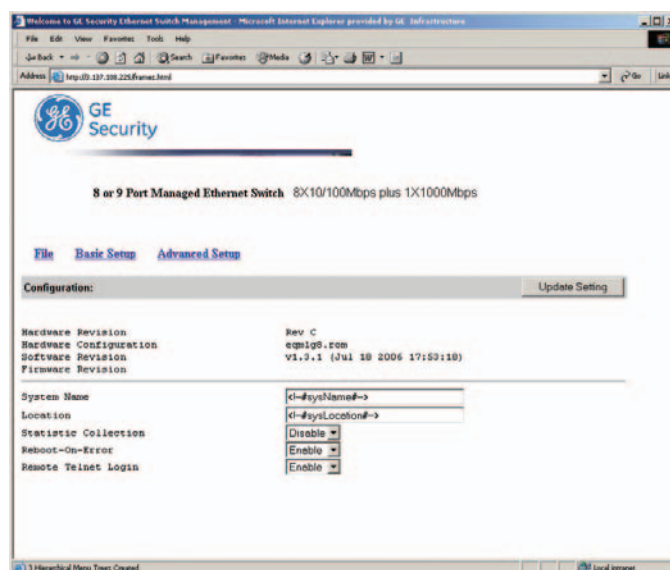

Step 2: System Name

Click in **System Name** text box on the field of **Basic Setup/General**.

Step 3:

Type a system name if it is blank, or replace the current system name with a new one.

Step 4: Location

Click in **Location** text box on the field of **Basic Setup/General**.

Step 5:

Type a location name if it is blank, or replace the current location name with a new one.

Step 6: Statistic Collection

To enable or disable statistics collection at the switch, click the appropriate option from **Statistic Collection** drop-down menu.

Step 7: Reboot-On-Error

To allow or prevent the switch from rebooting when a fatal error is detected, click the appropriate option from **Reboot-On-Error** drop-down menu.

Step 8: Remote Telnet Login

To enable or disable access to the switch management program via Telnet, click the appropriate option from **Remote Telnet Login** drop-down menu.

Step 9:

Click **Update Setting**. A confirmation window appears.

LAN Port Configuration

Step 1:

To access the LAN configuration parameters, click **Basic Setup** button first and then point to **LAN Port** and click a suitable option.

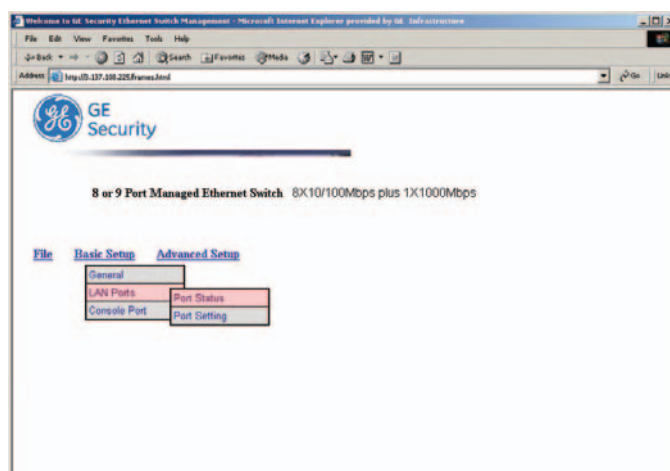

Step 2: Port Status

Click **Port Status** to view the line speed and flow control for all ports.

Port	Speed	Type	Link Status	Duplex Status	Flow Control Status
Port 1 (1)	100M bps		Down	N/A	N/A
Port 2 (2)	100M bps		Down	N/A	N/A
Port 3 (3)	100M bps		Down	N/A	N/A
Port 4 (4)	100M bps		Down	N/A	N/A
Port 5 (5)	100M bps		Up	100M bps	Full Enable
Port 6 (6)	100M bps		Down	N/A	N/A
Port 7 (7)			Down	N/A	N/A
Port 8 (8)			Down	N/A	N/A
Port 9 (A)	1G bps		Down	N/A	N/A

Note: The information displayed automatically updates every 15 seconds, without requiring you to refresh the window.

Step 3: Port Setting

Click **Port Setting** to access the configuration information for all ports.

Port	Speed	Type	Admin Setting	Speed Setting	Duplex Setting	Flow Control Setting
Port 1 (1)	100M bps		Up	Auto	Auto	Enable
Port 2 (2)	100M bps		Up	Auto	Auto	Enable
Port 3 (3)	100M bps		Up	Auto	Auto	Enable
Port 4 (4)	100M bps		Up	Auto	Auto	Enable
Port 5 (5)	100M bps		Up	Auto	Auto	Enable
Port 6 (6)	100M bps		Up	Auto	Auto	Enable
Port 7 (7)			Up	100M bps	Full	Enable
Port 8 (8)			Up	100M bps	Full	Enable
Port 9 (A)	1G bps		Up	Auto	Auto	Enable

Step 4:

In the **Port** column, click the port you want to configure. E.g. click Port 1.

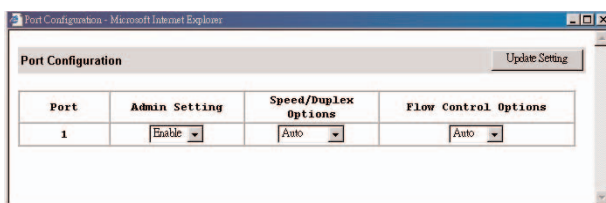

Step 5:

Click the drop-down menu under **Admin Setting**, decide to disable or enable it.

Note:

Disable - places the port in DOWN state.

In this state, packets cannot be switched to and from the port.

Enable: places the port in UP state.

In this state, packets can be switched to and from the port.

Step 6:

Click the drop-down menu under **Speed/Duplex Options** if you want to change the line speed and duplex settings.

Note:

Auto: allows the switch to automatically ascertain the line speed and duplex mode. All the other selections force the port to use a specific line speed and duplex mode. 'HD' denotes half-duplex mode; FD denotes full-duplex mode.

Step 7:

Click the drop-down menu under **Flow Control Options** if you want to configure the flow control for this port.

Note:

Auto: allows the switch to automatically decide whether or not to use flow control.

Disable: turns off flow control at all times.

Enable: turns on flow control at all times.

Step 8:

Click **Update Setting** when completed. A confirmation window appears.

Note:

For your convenience, click the LED's on the image of the switch and view its current speed, duplex, and link activity.

Console Port Configuration

Step 1:

To access the console port configuration parameters, click **Basic Setup** button first and then click **Console Port**.

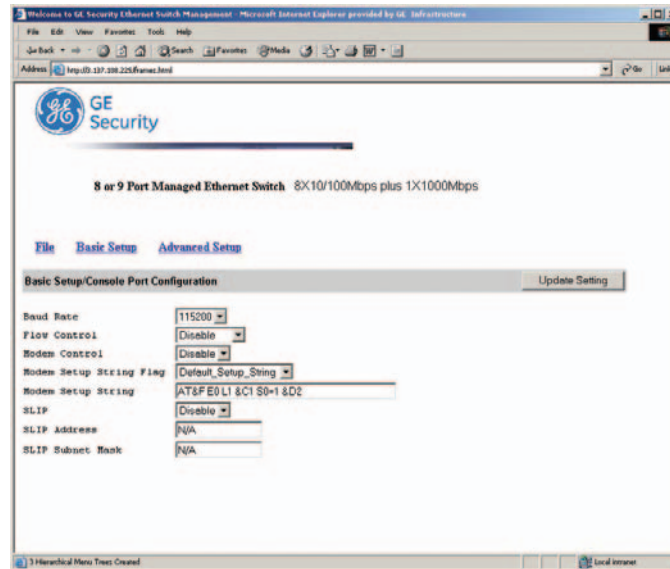

Step 2: Baud Rate

Click an appropriate speed from **Baud Rate** drop-down menu on the field of **Basic Setup/Console Port Configuration**.

Note:

Auto: allows the switch to Auto-baud between 9600bps and 115,200bps. All the other selections force a specific console baud rate.

Step 3: Flow Control

Click a flow control method from **Flow Control** drop-down menu.

Step 4: Modem Control

Step 5: Modem Setup String Flag

Step 6: Modem Setup String

Step 7:

Click **Update Setting** when completed. A confirmation window appears.

PERFORMING ADVANCED SETUP ACTIVITIES

To Perform Advanced Setup Activities:

Click the [Advanced Setup] button at the upper field of the main display, the menu options appear.

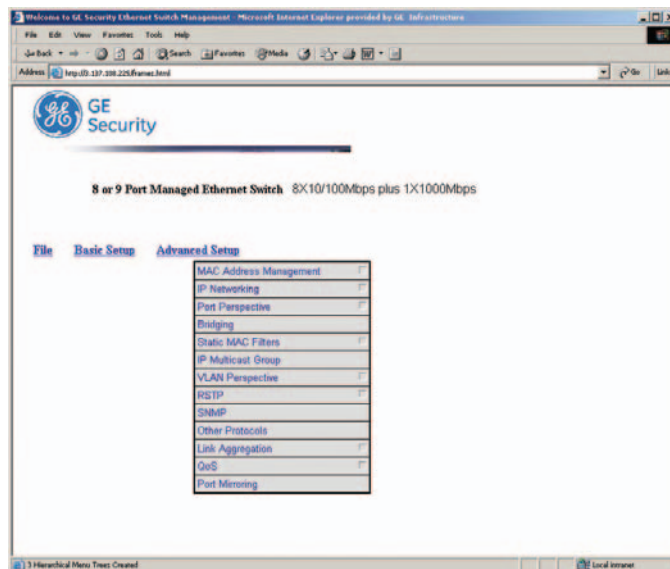

MAC Address Management

Step 1:

From the **Advanced Setup** menu, point to **MAC Address Management** to view VLANs and their associated MAC addresses.

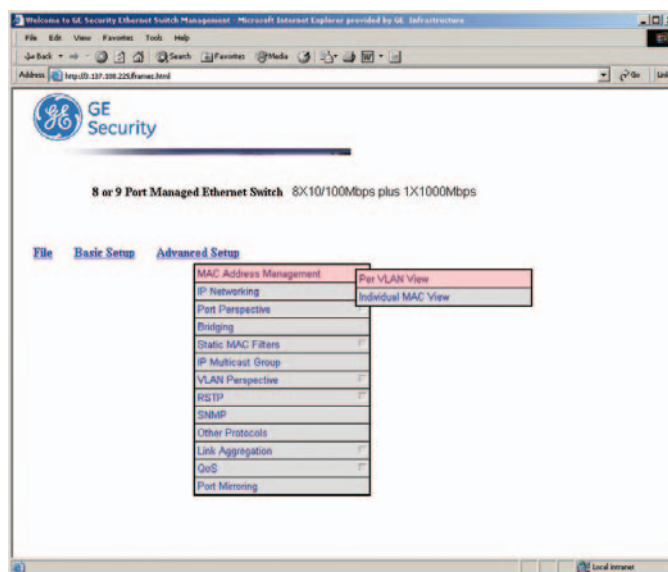

Step 2: Per VLAN View

Click **Per VLAN View** first and click on the port that you want to view. Close the **VLAN Activities** window when finished viewing.

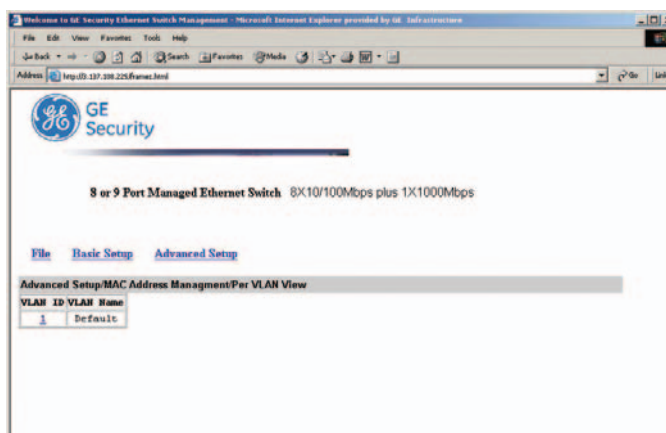

Step 3: Per Port View

Click **Per Port View** first and click on the port that you want to view. Close the **Per Port VLAN Activities** window when finished viewing.

Step 4: Individual MAC View

From the **Advanced Setup** menu as shown in **Step 1**, point to **MAC Address Management**. Click **Individual MAC View**.

Step 5:

Click in the **Enter MAC Address** text box and type the MAC address that you want to view. Then click on the **Get Information** button.

Step 6:

Close the **Individual MAC View** window when finished viewing.

IP Networking

To access the IP networking parameters, click the **Advanced Setup** button, and Point to **IP Networking** from the selection menu.

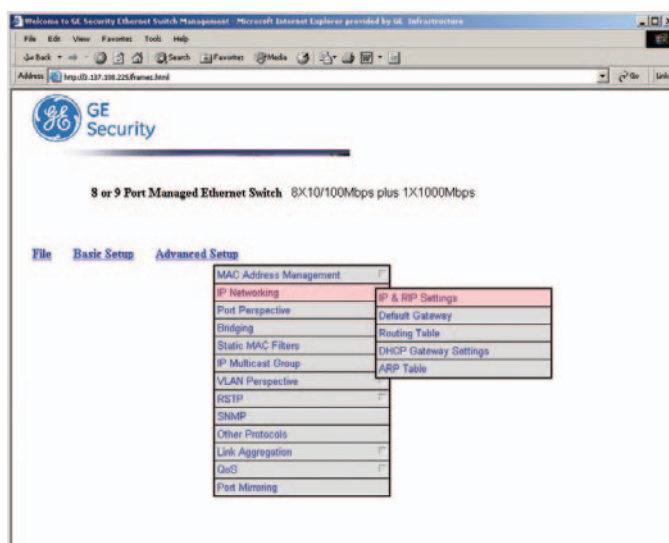

Step 1: IP & RIP Settings

Click **IP & RIP Settings** to access IP and RIP settings.

A list of VLAN IDs appears, along with their corresponding IP address and subnet mask.

Step 2:

In the **VLAN ID** column, click a VLAN ID whose settings you want to view and/or change.

Step 3:

To change the **IP Address**, click in the text box and type a new address.

Alternatively, you can use the **Delete IP** button to delete the IP address.

Caution:

- * No precautionary message appears before you delete the IP address.
- * Be sure you want to delete it before doing so.
- * The IP address is not deleted until you click **Update Setting**.

Step 4:

To change the **IP Subnet Mask**, click in the text box and type a new address.

Step 5:

To change the **Frame Type**, click a value from the drop-down list.

Step 6:

To change the **BOOTP** selection, click a value from the drop-down list.

Step 7:

To change the **Proxy ARP** selection, click a value from the drop-down list.

Step 8:

To change the **RIP Setting**, click a value from the drop-down list.

Step 9:

Specify whether you want to broadcast, multicast, or neither from the drop-down list.

Step 10:

Specify whether you want to advertise routes.

Step 11:

Specify whether you want to advertise the default route.

Step 12:

Specify whether you want to accept RIP V1/V2 updates.

Step 13:

Specify whether you want to accept default route updates.

Click to close the confirmation window.

Step 14:

Specify whether split horizon is to be used.

Step 15:

Specify whether poisoned reverse is to be used.

Step 16:

Specify whether the switch is to send triggered responses.

Step 17:

When you finished with these selections, click Update Setting.

A confirmation window appears. Click to close the confirmation window.

Per Port Statistics

Step 1:

To access per port statistics, click the Advanced Setup button, and then click Per Port Statistics from the selection menu.

Step 2:

Click a port to view statistic data.

Step 3:

Click Update Setting when completed.

Port Priority

Step 1:

To access port priority, click the **Advanced Setup** button, and then click **Port Priority** from the selection menu.

Step 2:

Click a port to change the priority level.

Step 3:

Click the drop-down list for setting a proper priority level.

Step 4:

Click Update Setting when completed.

Bridging

Step 1:

To access bridging parameters, click the **Advanced Setup** button, and then click **Bridging** from the selection menu.

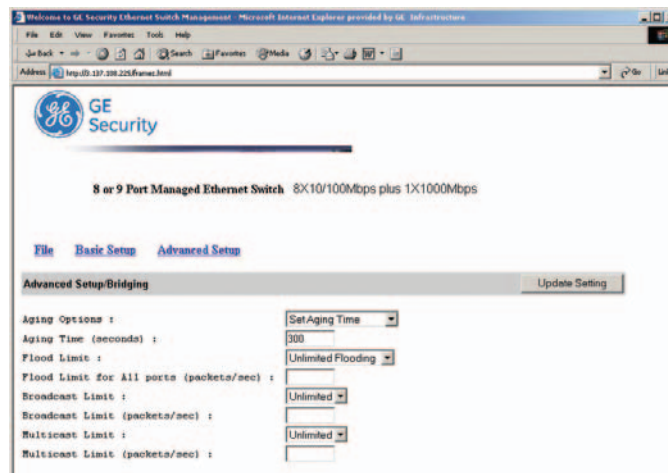

Step 2: Aging Options

Click the drop-down list for **Disabled** (No Aging) or **Set Aging Time**.

Step 3: Aging Time

Click the text box and type a decimal number as bridge aging period in seconds.

Step 4: Flood Limit

Click the drop-down list for **No Flooding**, **Controlled Flooding**, **Unlimited Flooding**.

Step 5: Flood Limit for All Ports

Click the text box and type a decimal number as flood limit in packets per second.

Static MAC Filter

To access the static MAC filter parameters, click the **Advanced Setup** button, and point to **Static MAC Filter** in the selection menu.

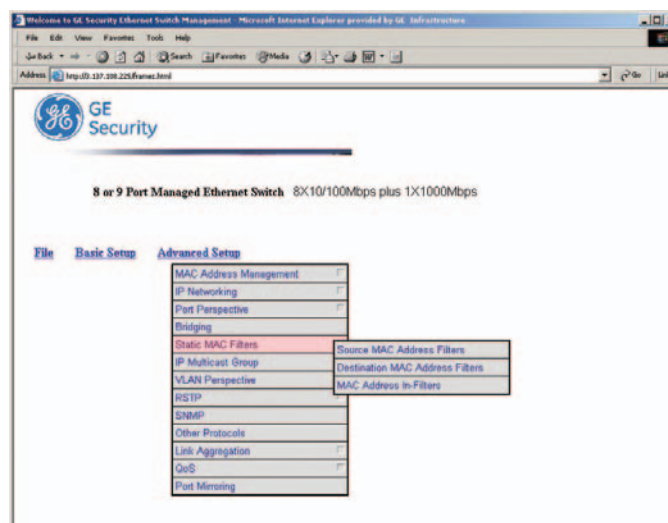

Step 1: Source MAC Address Filter

Click **Source MAC Address Filters**.

Step 2:

Click **Add MAC Addr** button to add a source MAC address for static filtering.

Step 3:

The **Static Source MAC Filter** window appears. Click in the **Source MAC Address Filter** text box and type a unique MAC source address you want to add. Then click the **Add** button.

Step 4:

A confirmation window appears. Close the confirmation window.

Step 5:

If you no longer need a source MAC address, click **Delete MAC Addr** button to delete it in **Step 2**.

Step 6:

The **Delete Source MAC Address** window appears. Click the **Select a MAC Address** drop-down list and select the source MAC address you want to delete. Then click the **Delete** button.

Step 7:

A confirmation window appears. Close the confirmation window.

Step 1: Destination MAC Address

Click the **Advanced Setup** button, and point to **Static MAC Filter** in the selection menu. Click **Destination MAC Address**.

Step 2:

Click **Add MAC Addr** button to add a destination MAC address for static filtering. Refer to **Step 2~4** in **Source MAC Address** section for similar procedure.

Step 3:

Click **Delete MAC Addr** button to delete a destination MAC address for static filtering. Refer to **Step 5~7** in **Source MAC Address** section for similar procedure.

IP Multicast Group

To view the IP multicast group addresses, click the **Advanced Setup** button, and click **IP Multicast Group** in the selection menu. The information is read-only.

VLAN Perspective

To view the VLAN configuration information, click the **Advanced Setup** button, and point to **VLAN Perspective** in the selection menu.

IP Multicast Group

To view the IP multicast group addresses, click the **Advanced Setup** button, and click **IP Multicast Group** in the selection menu. The information is read-only.

VLAN Perspective

To view the VLAN configuration information, click the **Advanced Setup** button, and point to **VLAN Perspective** in the selection menu.

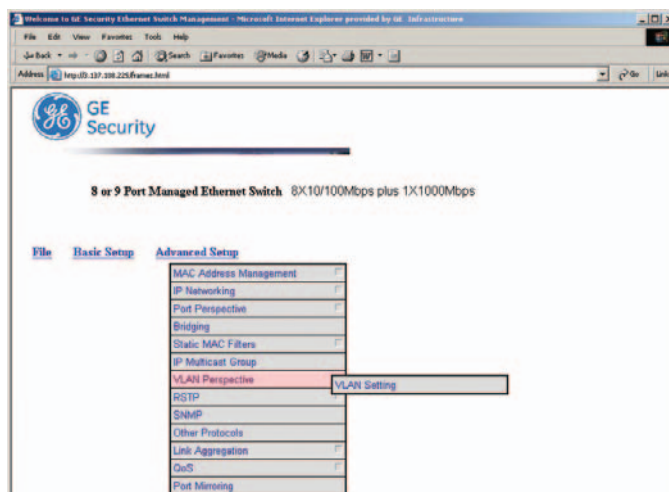

Step 1: VLAN Configuration

Click **VLAN Configuration**.

Step 2:

Click on a **VLAN ID** whose VLAN configuration you want to change.

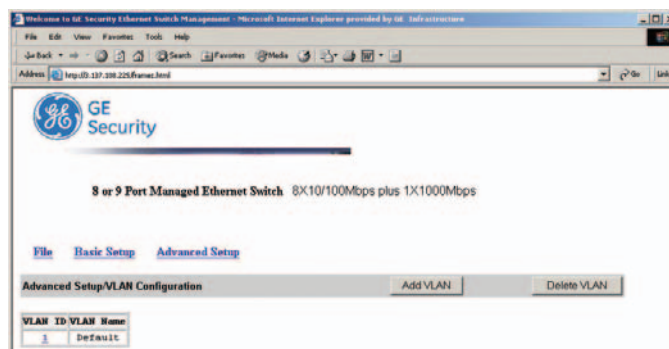

Step 3:

The **VLAN Information** window appears. Click to assign switch ports to VLAN ID 1. For each switch, the port options include **Tagged Ports**, **Untagged Ports**, or **Forbidden Ports**.

Step 4:

Click to close the **VLAN Information** window.

Step 5: Add a VLAN Entry

Click on the **Add VLAN** button to create a new VLAN.

IP Multicast Group

To view the IP multicast group addresses, click the **Advanced Setup** button, and click **IP Multicast Group** in the selection menu. The information is read-only.

VLAN Perspective

To view the VLAN configuration information, click the **Advanced Setup** button, and point to **VLAN Perspective** in the selection menu.

Step 6:

The **Add a VLAN Entry** window appears.

Step 7:

Click in the **VLAN ID** text box and specify a new VLAN ID number.

Step 8:

Click in the **VLAN Name** text box and type a name for this newly created VLAN.

Step 9:

Click to assign switch ports to this VLAN. For each switch, the port options include **Tagged Ports**, **Untagged Ports**, or **Forbidden Ports**.

Step 10:

Click **Add Now** button.

Step 11: Delete a VLAN Entry

Click on the **Delete VLAN** button to delete a VLAN. VLAN ID 1 is the default VLAN and cannot be deleted.

Step 12:

The **Delete a VLAN Entry** window appears.

Step 13:

Click the drop-down menu to select a VLAN ID, which you want to delete.

Step 14:

Click the **Delete** button.

Caution:

* No precautionary message appears before you delete a VLAN.

Link Aggregation

To view the spanning tree perspective parameters, click the **Advanced Setup** button, and point to **Link Aggregation** in the selection menu.

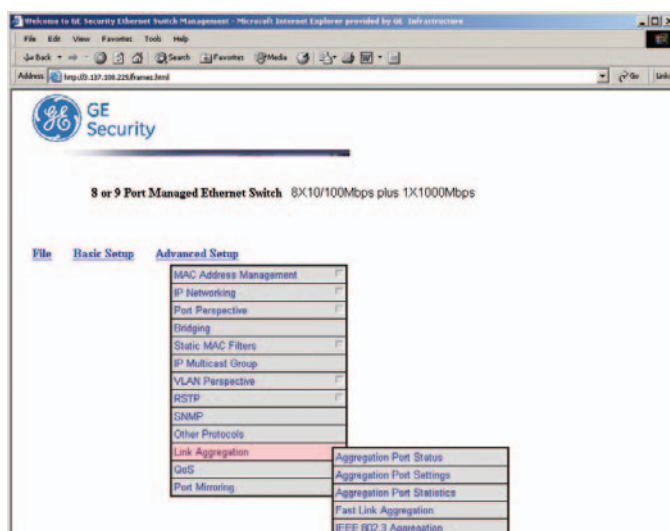

Step 1: Aggregation Port Status

To view and/or change the Aggregation configurations, click **Port Link Aggregation** from the above screen.

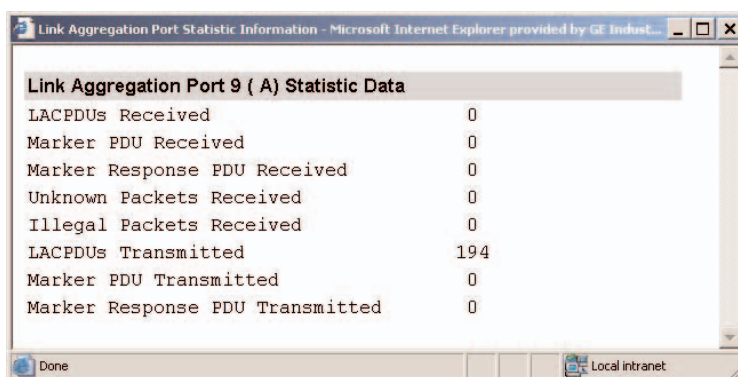

Step 2:

For **Link Aggregation**, specify whether you want to have it Disabled or Enabled by clicking the drop-down list.

Step 3:

For **Bridge Priority**, click in the text box and type a decimal number between 0 and 65535.

Step 4:

For **Hello Time**, click in the text box and type a decimal number between 0 and 10.

Step 5:

For **Max Age**, click in the text box and type a decimal number between 6 and 40.

Step 6:

For **Forward Delay**, click in the text box and type a decimal number between 4 and 30.

Step 7:
Click **Update Setting**. A confirmation window appears. Close the confirmation window.

Step 1: Port Setting

To view and/or change the Spanning Tree configurations by port, click the **Advanced Setup** button, point to **Link Aggregation** in the selection menu, and click **Aggregation Port Settings**.

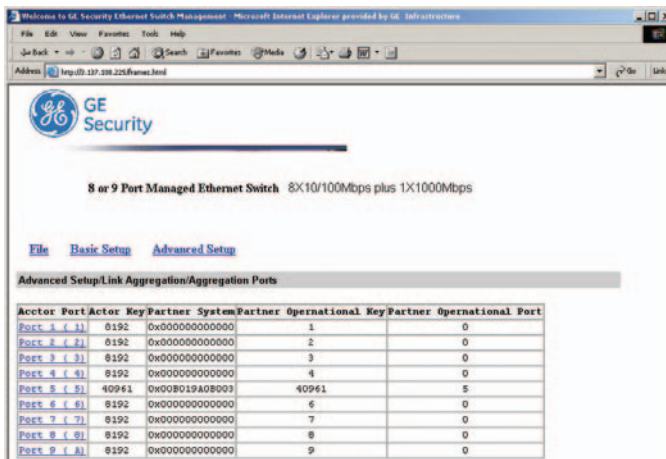

Step 2:
In the **Port** column, click the port whose Aggregation information you want to view.

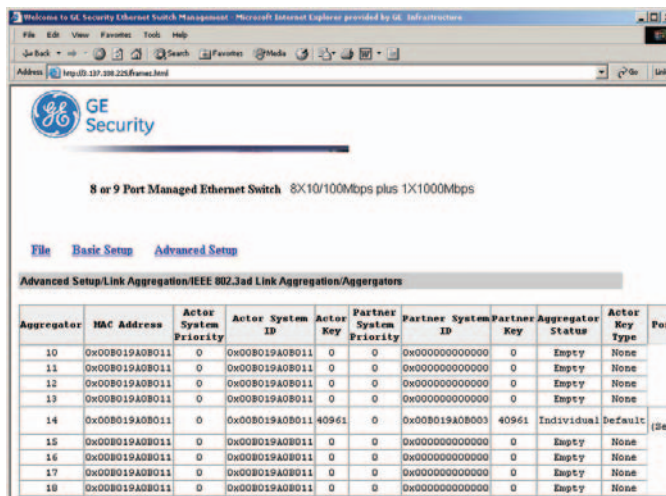

Step 3:
For **Port Priority**, click in the text box and type a decimal number between 0 and 255. A low value gives the port a greater likelihood of becoming a Root port.

Step 4:
For **Path Cost**, click in the text box and type a decimal number as a new path cost value.

Step 5:
For **Port Status**, specify whether the port is up or down by clicking the drop-down list.

Step 6:
Click **Update Setting**. A confirmation window appears. Close the confirmation window.

SNMP

To view and/or change all SNMP-related information, click the **Advanced Setup** button, and click **SNMP** in the selection menu. The **SNMP Configurations** window appears. As shown below, the factory-default **SNMP** value is **enabled** and the factory-default **Community Name** value is **public**.

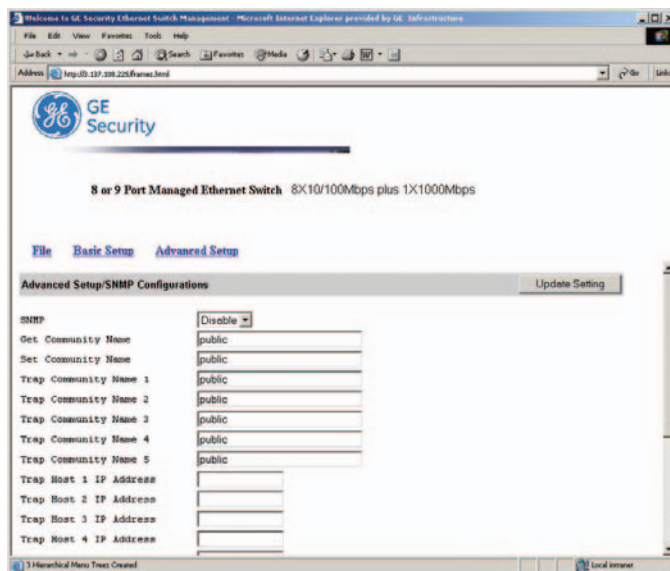

Step 1: SNMP

For **SNMP**, specify whether it is Disabled or Enabled by clicking the drop-down list.

Step 2: Get Community Name

For **Get Community Name**, click in the text box and type a get community name.

Step 3: Set Community Name

For **Set Community Name**, click in the text box and type a set community name.

Step 4: Trap Community Name

For each **Trap Community Name**, click in the text box and type a trap community name.

Step 5: Trap Host IP Address

For each **Trap Host IP Address**, click in the text box and type a IP address for trap host 1~4.

Step 6: Cold Start Trap

For **Cold Start Trap**, specify whether it is Disabled or Enabled by clicking the drop-down list.

Step 7: Warm Start Trap

For **Warm Start Trap**, specify whether it is Disabled or Enabled by clicking the drop-down list.

Step 8: Link Down Trap

For **Link Down Trap**, specify whether it is Disabled or Enabled by clicking the drop-down list.

Step 9: Link Up Trap

For **Link Up Trap**, specify whether it is Disabled or Enabled by clicking the drop-down list.

Step 10: Authentication Failure Trap

For **Authentication Failure Trap**, specify whether it is Disabled or Enabled by clicking the drop-down list.

Step 11: Rising Alarm Trap

For **Rising Alarm Trap**, specify whether it is Disabled or Enabled by clicking the drop-down list.

Step 12: Falling Alarm Trap

For **Falling Alarm Trap**, specify whether it is Disabled or Enabled by clicking the drop-down list.

Step 13: Topology Alarm Trap

For **Topology Alarm Trap**, specify whether it is Disabled or Enabled by clicking the drop-down list.

Step 14: Update Setting

Click **Update Setting** when completed. A confirmation window appears.

Close the confirmation window.

Other Protocols

To enable or disable the GVRP and/or IGMP protocols, click the **Advanced Setup** button, and click **Other Protocols** in the selection menu.

Step 1: GVRP

For **GVRP**, specify whether it is Disabled or Enabled by clicking the drop-down list.

Step 2: IGMP

For **IGMP**, specify whether it is disabled or Passive or Active by clicking the drop-down list.

Step 3: Update Setting

Click **Update Setting** when completed. A confirmation window appears.

Close the confirmation window.

Port Mirroring

To use the switch's mirroring capability to mirror one port to Port 1, click the **Advanced Setup** button, and click **Port Mirroring** in the selection menu. Click **Port 1** in the **Mirror To** column.

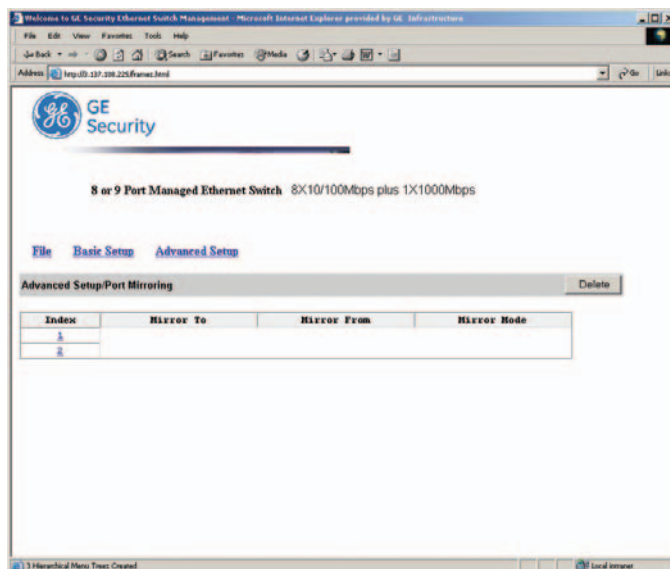

Step 1: Mirror From

In the **Mirror From** column, select a "mirror from" port by clicking the drop-down list. Data traffic from this port will mirror to **Port 1**.

Step 2: Mirror Mode

In the **Mirror Mode** column, specify whether the "mirrored from" port will be receiving or transmitting data by clicking the drop-down list.

Step 3: Update Setting

Click **Update Setting** when completed. A confirmation window appears. Close the confirmation window.

SNMP & RMON MANAGEMENT

This section describes the switch's Simple Network Management Protocol (SNMP) and Remote Monitoring (RMON) capabilities.

OVERVIEW

RMON is an abbreviation for the Remote Monitoring MIB (Management Information Base). RMON is a system defined by the Internet Engineering Task Force (IETF) document RFC 1757, which defines how networks can be monitored remotely.

RMONs typically consist of two components: an RMON probe and a management workstation:

- **The RMON probe is an intelligent device or software agent that continually collects statistics about a LAN segment or VLAN. The RMON probe transfers the collected data to a management workstation on request or when a pre-defined threshold is reached.**
- **The management workstation collects the statistics that the RMON probe gathers. The workstation can reside on the same network as the probe, or it can have an in-band or out-of-band connection to the probe.**

The switch provides RMON capabilities that allow network administrators to set parameters and view statistical counters defined in MIB-II, Bridge MIB, and RMON MIB. RMON activities are performed at a Network Management Station running an SNMP network management application with graphical user interface.

SNMP AGENT AND MIB-2 (RFC 1213)

The SNMP Agent running on the switch manager CPU is responsible for:

- **Retrieving MIB counters from various layers of software modules according to the SNMP GET/GET NEXT frame messages.**
- **Setting MIB variables according to the SNMP SET frame message.**
- **Generating an SNMP TRAP frame message to the Network Management Station if the threshold of a certain MIB counter is reached or if other trap conditions (such as the following) are met:**

Warm start
Cold start
Link up
Link down
Authentication failure
Rising alarm
Falling alarm
Topology alarm

MIB-2 defines a set of manageable objects in various layers of the TCP/IP protocol suites. MIB-2 covers all manageable objects from layer 1 to layer 4 and, as a result, is the major SNMP MIB supported by all vendors in the networking industry. The switch supports a complete implementation of SNMP Agent and MIB-2.

RMON MIB (RFC 1757) AND BRIDGE MIB (RFC 1493)

The switch provides hardware-based RMON counters in the switch chipset. The switch manager CPU polls these counters periodically to collect the statistics in a format that complies with the RMON MIB definition.

RMON Groups Supported

The switch supports the following RMON MIB groups defined in RFC 1757:

- **RMON Statistics Group** – maintains utilization and error statistics for the switch port being monitored.
- **RMON History Group** – gathers and stores periodic statistical samples from the previous Statistics Group.
- **RMON Alarm Group** – allows a network administrator to define alarm thresholds for any MIB variable. An alarm can be associated with Low Threshold, High Threshold, or both. A trigger can trigger an alarm when the value of a specific MIB variable exceeds a threshold, falls below a threshold, or exceeds or falls below a threshold.

RMON Event Group – allows a network administrator to define actions based on alarms. SNMP Traps are generated when RMON Alarms are triggered. The action taken in the Network Management Station depends on the specific network management application.

Bridge Groups Supported

The switch supports the following four groups of Bridge MIB (RFC 1493):

- **The dot1dBase Group** – a mandatory group that contains the objects applicable to all types of bridges.
- **The dot1dStp Group** – contains objects that denote the bridge's state with respect to the Spanning Tree Protocol. If a node does not implement the Spanning Tree Protocol, this group will not be implemented. This group is applicable to any transparent only, source route, or SRT bridge that implements the Spanning Tree Protocol.
- **The dot1dTp Group** – contains objects that describe the entity's transparent bridging status. This group is applicable to transparent operation only and SRT bridges.
- **The dot1dStatic Group** – contains objects that describe the entity's destination-address filtering status. This group is applicable to any type of bridge which performs destination-address filtering.

SPECIFICATIONS

Manageable 8/9-Port Switch	10/100/1000BaseT/TX auto-negotiating ports with RJ-45 connectors and 100/1000BaseFX fiber ports combination
Applicable Standards	IEEE 802.3 10BaseT IEEE 802.3u, ab 100/1000BaseTX/FX
Switching Method	Store-and-Forward
Forwarding Rate	
10BaseT:	10 / 20Mbps half / full-duplex
100BaseTX:	100 / 200Mbps half / full-duplex
1000BaseTX:	1000/2000Mbps half/ full-duplex
Performance	148,80pps for 10Mbps 148,800pps for 100Mbps 1,488,000pps for 1000Mbps
Cable	
110BaseT:	2-pair UTP/STP Cat. 5, 5E, 6
100/1000BaseTX:	2-pair UTP/STP Cat. 5E Both up to 100m (328ft)
100/1000BaseFX:	MMF (50 or 62.5_m), SMF (9 or10_m)
LED Indicators	Per unit – Power status Per port – LNK (Link) /ACT (Activity) FDX/COL
Dimensions	W 8.5 in _ D 7.5 in _ H 1.75 in
Net Weight	4.5 lbs. Approx.
Power Input	External power adapter 12-24V DC; 1A
Power Consumption	12W max.
Operating Temperature	-40°C to 74° C
Storage Temperature	-40°C to 85° C
Humidity	0%-95% non-condensing
Emissions	FCC part 15 Class A, NEMA TS2, UL, CE Mark Class A

APPENDIX A - CONNECTOR PINOUTS

Pin arrangement of RJ-45 connectors:

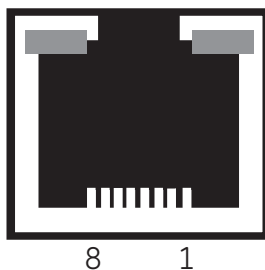

The following table lists the pin out of 10/100/1000BaseT/TX ports.

Pin	Regular Ports	Uplink Port
1	Input Receive Data +	Output Transmit Data +
2	Input Receive Data -	Output Transmit Data -
3	Output Transmit Data +	Input Receive Data +
4	NC	NC
5	NC	NC
6	Output Transmit Data -	Input Receive Data -
7	NC	NC
8	NC	NC

Limited Warranty

a. GE Security warrants that its products are free from defects in workmanship and materials, and will conform to GE Security's published specifications, subject to the terms of this limited warranty. With respect to any product furnished by GE Security, the foregoing shall apply only to failures to meet said warranty that appear within the applicable warranty period set forth in the *Security Equipment Return and Warranty Policy Statement* on our website. The warranty extends only to Buyer and does not extend to any other party. GE Security is not responsible for conditions or applications over which GE Security has no control. Defects or problems as a result of such conditions or applications are not the responsibility of GE Security. Such conditions include normal wear and tear; catastrophe; fault or negligence of the user or a party other than GE Security; improper installation, application, storage, maintenance, or use of products; other causes external to products; or failure to conform to any applicable recommendations of GE Security. The warranty does not cover, and GE Security does not warrant, batteries of any type used in connection with other products furnished. To the extent that any product includes software or firmware, whether included in a product furnished hereunder or provided separately, GE Security warrants that such software/firmware will, at the time of delivery by GE security, conform in all material respects to GE Security's documentation relating to such software/firmware.

b. If any product fails to meet the limited warranty, GE Security shall, at its option, correct any such failure by repairing any defective or damaged parts of damaged product, or make available, FOB shipping point, any necessary repaired or replacement parts. GE Security reserves the right to replace any product under warranty with new or remanufactured product. GE Security will not be responsible for labor costs of removal or reinstallation of products. The repaired or replaced product is then warranted under the terms of the limited warranty for the balance of the term of the warranty or for 90 days, whichever is longer. For any warranty claim, Buyer should contact Customer Service and request authorization to return the product.

c. The preceding subsections of this limited warranty set forth the exclusive remedies for claims based on any defect, failure, malfunction, or any other performance or nonperformance of any product, whether the claim is in contract, indemnity, warranty, tort (including negligence), strict liability or otherwise, and however instituted. Upon expiration of the applicable limited warranty period, any liability of GE security in connection with such exclusive remedies shall terminate, and Buyer shall have 30 days after the warranty period to give written notice of any defects, failures, malfunctions, or other performance or nonperformance issue that appeared during the warranty period. Except as set forth in the section entitled *Patents*, the foregoing limited warranty is exclusive and in lieu of all other warranties, whether written, oral, implied, or statutory. NO IMPLIED WARRANTY OF MERCHANTABILITY OR FITNESS FOR PARTICULAR PURPOSE SHALL APPLY.

Customer Support

For assistance in installing, operating, maintaining, and troubleshooting this product, refer to this document and any other documentation provided. If you still have questions, please contact technical support during normal business hours (Monday through Friday, excluding holidays, between 6 a.m. and 5 p.m. Pacific Time).

GE Security

Call: 888 437-3287 (US, including Alaska and Hawaii; Puerto Rico; Canada)

Outside the toll-free area: 503 885-5700

Fax: 561 998-6224

www.gesecurity.com



GE Security

www.GESecurity.com

U.S.
T (561) 998-6100
T 888-GE-SECURITY
888 (437-3287)

F 561 998-6224
Er-sbctinfo@gesecurity.com

Canada
T 519-376-2430
F 519-376-7258

Asia
T 852-2907-8108
F 852-2142-5063

Australia
T 61-3-9239-1200
F 61-3-9239-1299

Europe
T 44-113-238-1668
F 44-113-253-8121

Latin America
T 305-593-4301
F 305-593-4300

As a company of innovation, GE Security reserves the right to change product specifications without notice.
For the latest product specifications visit GE Security online at www.GESecurity.com or contact your GE Sales Representative.