

# NX-181xx NetworX Voice keypad with touch buttons Installation Manual

**Copyright** © 2015 UTC Fire & Security Americas Corporation, Inc.  
All rights reserved.

This document may not be copied in whole or in part or otherwise reproduced without prior written consent from UTC Fire & Security Americas Corporation, Inc., except where specifically permitted under US and international copyright law.

**Trademarks and patents** The NX-181xx name and logo are trademarks of UTC Fire & Security Americas Corporation, Inc.

Other trade names used in this document may be trademarks or registered trademarks of the manufacturers or vendors of the respective products.

**Manufacturer** Placed on the market by:  
UTC Fire & Security Americas Corporation, Inc.  
3211 Progress Drive, Lincoln, NC, 28092, USA

Authorized EU manufacturing representative:  
UTC Fire & Security B.V.  
Kelvinstraat 7, 6003 DH Weert, Netherlands

**FCC compliance** This equipment has been tested and found to comply with the limits for a Class B digital device, pursuant to part 15 of the FCC Rules. These limits are designed to provide reasonable protection against harmful interference when the equipment is operated in a commercial environment. This equipment generates, uses, and can radiate radio frequency energy and, if not installed and used in accordance with the instruction manual, may cause harmful interference to radio communications.

You are cautioned that any changes or modifications not expressly approved by the party responsible for compliance could void the user's authority to operate the equipment.

**NFPA 72** Check local ordinances, this device is not listed by an approved test lab to meet NFPA 72 and therefore may not be sold or installed for use with a fire system in some localities.

**EU compliance** 

**EU directives** UTC Fire & Security hereby declares that this device is in compliance with the applicable requirements and provisions of one or more of the Directives 1999/5/EC, 2014/30/EU and 2014/35/EU. For more information see: [www.utcfireandsecurity.com](http://www.utcfireandsecurity.com) or [www.interlogix.com](http://www.interlogix.com)



**2012/19/EU (WEEE directive):** Products marked with this symbol cannot be disposed of as unsorted municipal waste in the European Union. For proper recycling, return this product to your local supplier upon the purchase of equivalent new equipment, or dispose of it at designated collection points. For more information see: [www.recyclethis.info](http://www.recyclethis.info).



**2006/66/EC (battery directive):** This product contains a battery that cannot be disposed of as unsorted municipal waste in the European Union. See the product documentation for specific battery information. The battery is marked with this symbol, which may include lettering to indicate cadmium (Cd), lead (Pb), or mercury (Hg). For proper recycling, return the battery to your supplier or to a designated collection point. For more information see: [www.recyclethis.info](http://www.recyclethis.info).

**Contact information** [www.utcfireandsecurity.com](http://www.utcfireandsecurity.com) or [www.interlogix.com](http://www.interlogix.com)

**Customer support** [www.interlogix.com/customer-support](http://www.interlogix.com/customer-support) or  
[www.utcssecurityproducts.eu](http://www.utcssecurityproducts.eu)

# Content

<b>Important information</b>	<b>4</b>
Limitation of liability	4
Advisory messages	4
Disclaimer	5
Warranty	5
<b>Installation</b>	<b>6</b>
Wiring Structure Note	7
<b>Advanced System Configuration</b>	<b>9</b>
<b>Panel and Device Configuration</b>	<b>13</b>
<b>Service provider phone number</b>	<b>14</b>
<b>Quick NX-181xx programming guide</b>	<b>15</b>
<b>Word Library</b>	<b>16</b>
<b>Cable Requirements</b>	<b>17</b>
<b>Specifications</b>	<b>18</b>

# Important information

## Limitation of liability

To the maximum extent permitted by applicable law, in no event will UTCFS be liable for any lost profits or business opportunities, loss of use, business interruption, loss of data, or any other indirect, special, incidental, or consequential damages under any theory of liability, whether based in contract, tort, negligence, product liability, or otherwise. Because some jurisdictions do not allow the exclusion or limitation of liability for consequential or incidental damages the preceding limitation may not apply to you. In any event the total liability of UTCFS shall not exceed the purchase price of the product. The foregoing limitation will apply to the maximum extent permitted by applicable law, regardless of whether UTCFS has been advised of the possibility of such damages and regardless of whether any remedy fails of its essential purpose.

Installation in accordance with this manual, applicable codes, and the instructions of the authority having jurisdiction is mandatory.

While every precaution has been taken during the preparation of this manual to ensure the accuracy of its contents, UTCFS assumes no responsibility for errors or omissions.

## Advisory messages

Advisory messages alert you to conditions or practices that can cause unwanted results. The advisory messages used in this document are shown and described below.

---

**WARNING:** Warning messages advise you of hazards that could result in injury or loss of life. They tell you which actions to take or to avoid in order to prevent the injury or loss of life.

---

---

**Caution:** Caution messages advise you of possible equipment damage. They tell you which actions to take or to avoid in order to prevent the damage.

---

**Note:** Note messages advise you of the possible loss of time or effort. They describe how to avoid the loss. Notes are also used to point out important information that you should read.

Keep in mind, the level of security you will obtain with this system relates specifically with two major factors:

- The quantity, quality, and placement of security devices attached to this security system.
- The knowledge you have of the security system and how that knowledge is utilized in a weekly test of the complete system.

This product is to be installed by qualified SERVICE PERSONNEL only.

The equipment should only be operated with an approved power adapter with insulated live pins.

---

**Caution:** Risk of explosion if battery is replaced by an incorrect type. Dispose of batteries according to the instructions. Contact your service provider for replacement batteries.

---

## Disclaimer

A level of TCP IP knowledge is required by the installer/s to set up some of the NX-181xx functionality. UTCSF limits its support to NX-181xx setup only, and is unable to offer further assistance on your client's DSL modem, router, firewall or any other 3<sup>rd</sup> party software. Please consult your customer's IT department or qualified IT professional about implementing this product onto your client's network.

## Warranty

UTC Fire & Security Americas Corporation, Inc. guarantees this product against defective parts and workmanship for twenty-four (24) months from the date of purchase. If any defect appears during the warranty period contact your service provider. UTC Fire & Security Americas Corporation, Inc. assumes no liability for consequential or indirect damage, and accepts no responsibility for repairing damage to the product caused by misuse, careless handling, or where repairs have been made by others.

No other guarantee, written or verbal, is authorized by UTC Fire & Security Americas Corporation, Inc.

# Installation

Remove the cap that's covering the locking mechanism, this is located on the bottom of the NX-181xx. With the cap removed you now have access to the locking mechanism that secures your NX-181xx to its mounting plate. Insert a small flat head screwdriver until it is located under the locking tongue.

Whilst turning either clockwise or counter clock wise, slide the NX-181xx down and clear of the locking tongue, you can now remove the NX-181xx from its mounting bracket. Use the fixings supplied to secure the mounting plate to the wall. The top of the NX-181xx will be 9 mm above the top of mounting bracket after it is locked back in place.

Figure 1: NX-181xx mounting

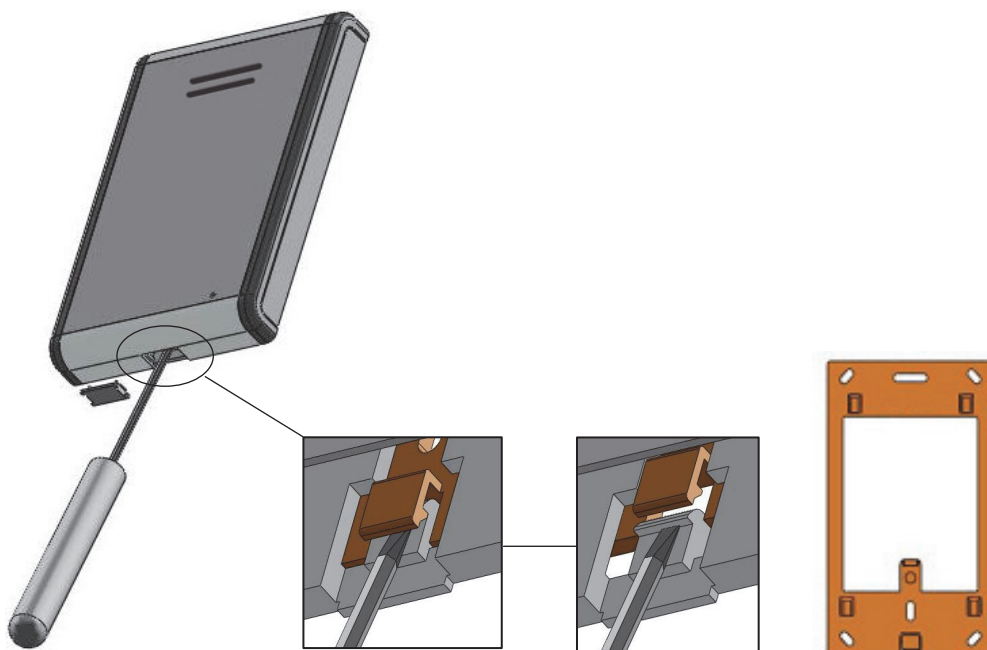
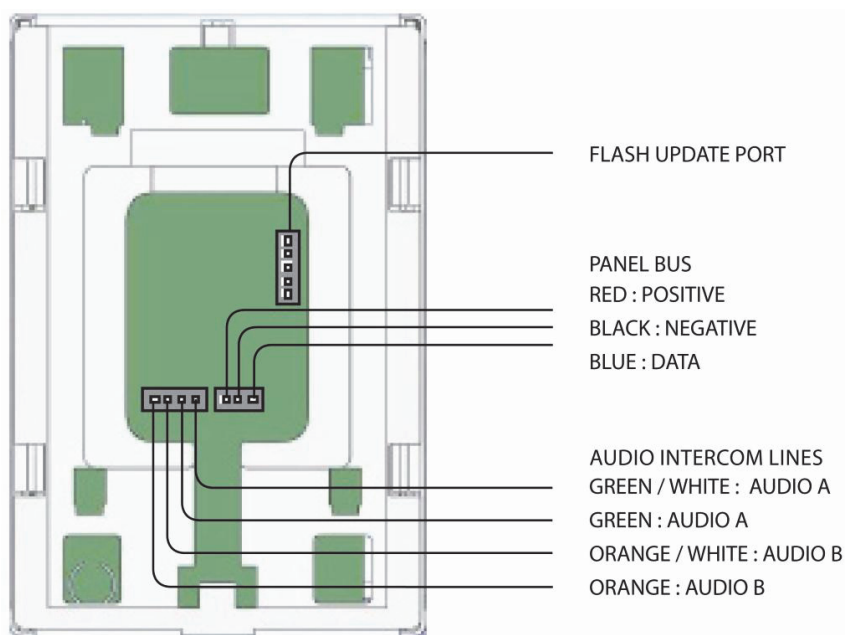
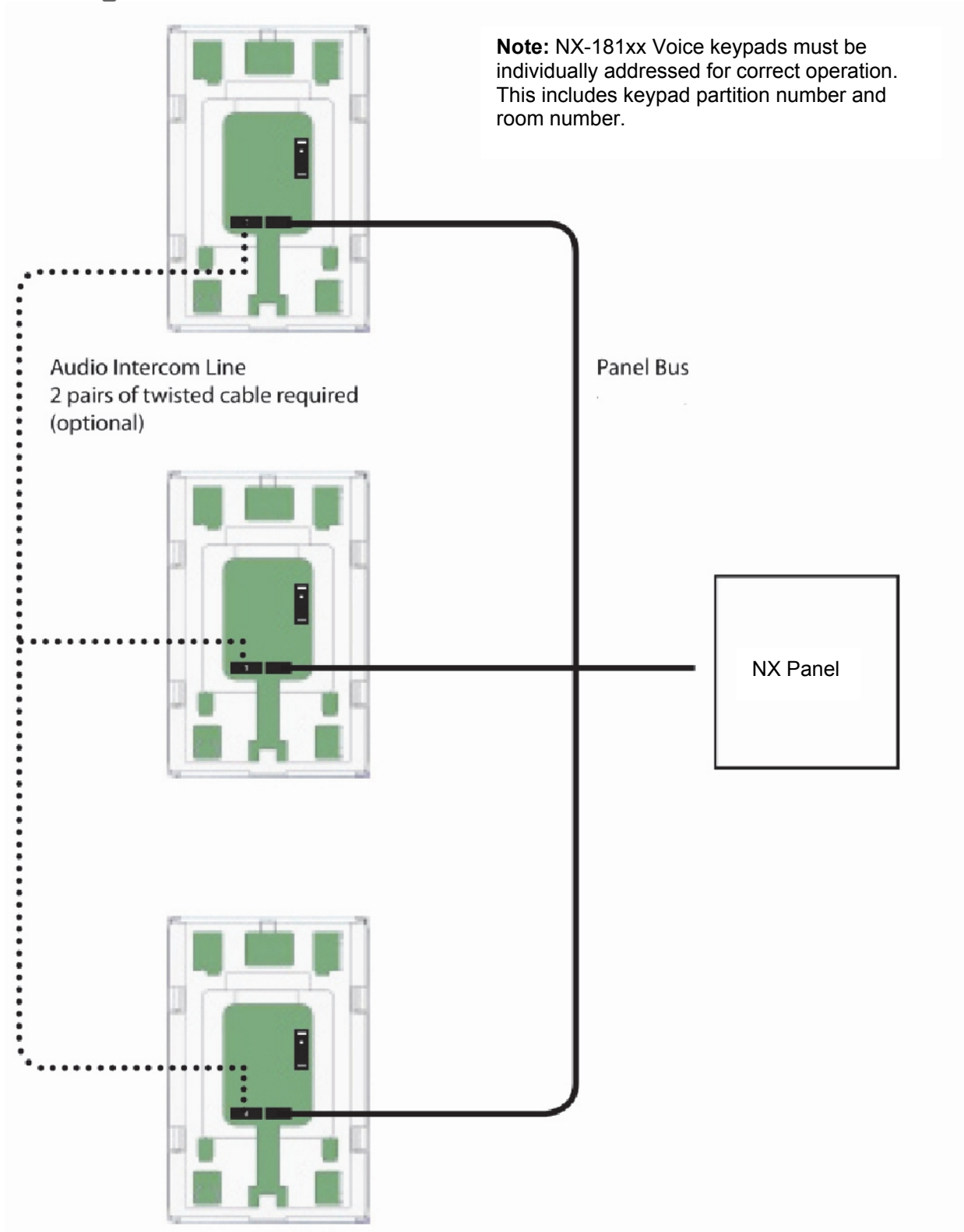

Figure 2: Rear view showing cable header pins



## Wiring Structure Note



**Note:** Both the audio line and data bus line can either be star or daisy chain wired. A maximum of 8 NX-181xx Voice keypads can be configured as room stations for intercom functionality. Two pairs of twisted cable (4 conductors) are required for the audio line, one pair for audio line A and another for audio line B.

Recordings are transferred between NX-181xx Voice keypads via the audio lines and a communication cable was specifically designed to transfer these recordings in installations that do not have dedicated audio cables installed, please contact your local Interlogix office for further details.

The audio line is not connected to the security panel.



# Advanced System Configuration



NX-181xx Main Menu

- 1 Zone Bypass
- 2 Zone Chime
- 3 Event History
- 4 System Test
- 5 User Configuration
- 6 Phone Numbers
- 7 Output Control
- 8 Voice Message Recording
- 9 Basic System Configuration
- 0** Advanced System Configuration

Touch 0



Advanced System Configuration

Enter programming code

?? ??

- 1** Keypad configuration
- 2 Panel & device configuration
- 3 Service provider phone number
- MENU Go Back

Touch 1

Keypad Configuration

- 1 Keypad number
- 2 Keypad partition number
- 3 Keypad room number
- 4 Keypad starting zone
- 5 Number of hours to auto test
- 6** Advanced keypad configuration
- 7 Touch sense control
- 8 Reserved
- 9 Reserved
- 0 Default keypad
- MENU Go Back

Touch 6



Advanced Keypad Configuration

- 1 Keypad tamper
- 2 Entry/exit beeps suppression
- 3 Stay arming key suppression
- 4 Reserved
- 5 Status key when armed suppression
- 6 Emergency keys beep enable
- 7 Partition/zone LEDs
- 8 Multi partition keypad
- MENU Go Back

View partition LEDs for status  
 On = Option is selected  
 Off = Option is not selected  
 Touch number to change

**[1] Keypad configuration:** This sub menu allows you to program the address, partition and room numbers of each keypad, along with other selectable options.

**[2] Panel & device configuration:** This is your access point to all devices that are on the bus network, such as the control panel, radio receivers, output modules etc.

**[3] Service provider phone number:** This is the phone number you wish your clients to call for servicing, this number will be announced each arming and disarming cycle whilst a system fault is present.

Step	Advanced system configuration – Keypad configuration	
1.	[MENU]-[0]	Selects main menu - Option 0, Advanced system configuration. <ul style="list-style-type: none"> <li>◀ Enter your code, touch menu to exit.</li> </ul>
2.	[?]-[?]-[?]-[?]	Enter your 4 or 6 digit Programming code. <ul style="list-style-type: none"> <li>Touch 1 for Keypad Configuration.</li> <li>Touch 2 for panel and device configuration.</li> <li>◀ Touch 3 to configure service provider phone number.</li> <li>Touch menu to exit.</li> </ul>
3.	[1]	Selects Keypad configuration. <ul style="list-style-type: none"> <li>◀ Announcement (all keypad options are announced)</li> </ul>
4.	[ ? ]	Select one of the keypad options (shown in tables below).
Next	[MENU]	Moves back to step 3, Advanced system configuration selection.
Next	[MENU]	Exits from Advanced system configuration.

When programming Advanced system configuration > Keypad configuration choose the option you wish to program from 1 to 8 (shown below) at step 4. All keypads should be defaulted prior to programming (option 0).

4.	[1]	<b>Option 1 - Keypad numbering</b> <ul style="list-style-type: none"> <li>◀ Keypad number is ?, select a keypad number, touch menu to go back</li> </ul>
5.	[ ? ]	Enter the keypad number <ul style="list-style-type: none"> <li>◀ Keypad number is ?, select a keypad number, touch menu to go back</li> </ul>
6.	[MENU]	Moves back to step 4, keypad option selection
4.	[2]	<b>Option 2 - Keypad Partition number</b> <ul style="list-style-type: none"> <li>◀ Keypad partition number is ?, select a keypad partition number, touch menu to go back.</li> </ul>
5.	[ ? ]	Enter the keypad partition number. <ul style="list-style-type: none"> <li>◀ Keypad partition number is ?, select a keypad partition number, touch menu to go back.</li> </ul>

6.	[MENU]	Moves back to step 4, keypad option selection.
<hr/>		
4.	[3]	<b>Option 3 - Keypad Room number</b>
		<ul style="list-style-type: none"> <li>Keypad room number is ?, select a keypad room number to configure, touch menu to go back.</li> </ul>
5.	[ ? ]	Enter the keypad room number.
		<ul style="list-style-type: none"> <li>Keypad room number is ?, select a keypad room number to configure, touch menu to go back.</li> </ul>
6.	[MENU]	Moves back to step 4, keypad configuration.
<hr/>		
4.	[4]	<b>Option 4 - Keypad Starting Zone</b>
		<ul style="list-style-type: none"> <li>Keypad starting zone is ?, select a keypad starting zone followed by enter, touch menu to go back.</li> </ul>
5.	[ ? ] [ENTER]	Enter the keypad starting zone
		<ul style="list-style-type: none"> <li>Keypad starting zone is ?, select a keypad starting zone followed by enter, touch menu to go back.</li> </ul>
6.	[MENU]	Moves back to step 4, keypad option selection
<hr/>		
4.	[5]	<b>Option 5 - Number of hours to Auto Test</b>
		<ul style="list-style-type: none"> <li>Hours before next auto test is ?, select hours before next auto test followed by enter, touch menu to go back.</li> </ul>
5.	[ ? ] [ENTER]	Enter the hours till next auto test.
		<ul style="list-style-type: none"> <li>Hours before next auto test is ?, select hours before next auto test followed by enter, touch menu to go back.</li> </ul>
6.	[MENU]	Moves back to step 4, keypad option selection.
<hr/>		
4.	[6]	<b>Option 6 - Advanced keypad Configuration</b>
		<ul style="list-style-type: none"> <li>Keypad option ? is enabled, keypad option ?is enabled Select from options 1 to 8 for advanced keypad configuration, touch menu to go back.</li> </ul>
5.	[ ? ]	Toggle options 1 to 8 On or Off
		<ul style="list-style-type: none"> <li>Keypad option ? is enabled / disabled, keypad option ?is enabled Select from options 1 to 8 for advanced keypad configuration, touch menu to go back.</li> </ul>
		View partition LEDs for option selection confirmation. Refer to the Table 1 below for descriptions.
6.	[MENU]	Moves back to step 4, keypad option selection.

**Table 1: Advanced keypad configuration options**

1	Enable keypad tamper switch	5	Status key read message when armed suppression
2	Entry / exit beeps suppression	6	Enable three second beeps on emergency keys before alarm
3	Stay arming key suppression	7	Enable Zone Leds 1 – 8 in lieu of partition Leds 1 - 8
4	Reserved	8	Enable multi partition keypad

---

**4. [7] Option 7 - Touch sense control (see note below)**

---

- ◀ Touch sensitivity is ?, select sensitivity from 51 to 255 followed by enter, touch menu to go back.
- 

5. [ ? ] Enter the required sensitivity level. 51 = more sensitive, 255 = less sensitive  
[ENTER]

---

- ◀ Touch sensitivity is ?, select sensitivity from 51 to 255 followed by enter, touch menu to go back.
- 

6. [MENU] Moves back to step 4, keypad option selection.

---



---

**4. [ 0 ] Option 0 - To Default keypad**

---

- ◀ Touch mute to confirm, touch menu to exit.
- 

5. [MUTE] Selects to Default keypad.

---

**WARNING:** this will default the keypad you are currently programming.

---

Automatically Moves back to step 4, keypad option selection

---

All NX-181xx Voice keypads must be individually addressed for proper security operation and must have individual room numbers assigned to enable intercom functionality.

Option 7, touch sense control, is the sensitivity setting for the NX-181xx to go from idle mode to run mode on the first touch. The setting options are from 51 milliseconds to 255 milliseconds, 51 being more sensitive and 255 being less sensitive. The default setting is set to 150 milliseconds

Run mode sensitivity is fixed at 50 milliseconds.

# Panel and Device Configuration

---

**Step Advanced system configuration – Panel and device configuration**

---

- |    |                  |  |
|----|------------------|--|
| 1. | [MENU]-[0]       | Selects main menu - Option 0, Advanced system configuration.<br>▶ Enter your code, touch menu to exit.   |
| 2. | [?]-[?]-[?]-[?]  | Enter your 4 or 6 digit Programming code.<br>Touch one for keypad configuration, touch two for panel and device configuration, touch three to configure service provider phone number, touch menu to exit. |
| 3. | [2]              | Selects Panel and device configuration.<br>▶ Select a device number followed by enter, touch menu to go back.  |
| 4. | [ ? ]<br>[ENTER] | Select the device you wish to program.<br>▶ Selected device? is connected, select a feature number followed by enter, touch menu to go back.   |
| 5. | [MENU]           | Moves back to step 4, select a device number.  |
| 6. | [MENU]           | Moves back to step 3, Advanced system configuration selection.   |
| 7. | [MENU]           | Exits from Advanced system configuration.  |
- 

## When in device programming:

Feature number then [ENTER], to move to the feature you wish to program.

Touch [MENU] to accept changes and move to the next segment.

Touch [ENTER] to exit the feature.

Touch [MENU] three times to exit device programming.

# Service provider phone number

---

Step	Advanced system configuration – Service provider phone number	
1.	[MENU]-[0]	Selects main menu - Option 0, Advanced system configuration. ◀ Enter your code, touch menu to exit.
2.	[?]-[?]-[?]-[?]	Enter your 4 or 6 digit Programming code. Touch 1 for Keypad Configuration. Touch 2 for panel and device configuration. ◀ Touch 3 to Configure Service Provider Phone Number. Touch menu to exit.
3.	[3]	Selects service provider phone number. ◀ Service provider phone number is disabled, select a new service provider phone number followed by enter, touch menu to go back.
4.	Phone Number	Enter the service provider phone number.
5.	[ENTER]	Accepts the phone number entered. ◀ Service provider phone number is enabled as Phone number, select a new service provider phone number followed by enter, touch zero followed by enter to disable service provider phone number, touch status to review service provider phone number, touch menu to go back.
6.	[MENU]	Moves back to step 3, Advanced system configuration selection.
7.	[MENU]	Exits from Advanced system configuration.

---

# Quick NX-181xx programming guide

## Default keypad:

[MENU] [ 0 ] > [Programming code ] > [ 1 ] [ 0 ] > [ MUTE ] > [MENU] > [MENU]

**Record user names:**  Speak to record, 2.0 seconds recording time

[MENU] [ 8 ] > [Master code] > [ 3 ] > [ 1 ] [ENTER]

---

 [TALK]  [ENTER] User 1



---

 [TALK]  [ENTER] User 2



---

 [TALK]  [ENTER] User 3



---

 [TALK]  [ENTER] User 4



---

 [TALK]  [ENTER] User 5



---

 [TALK]  [ENTER] User 6

---

 [TALK]  [ENTER] User 7

---

 [TALK]  [ENTER] User 8



---

Touch [MENU] [MENU] to exit.



**Record zone names:**  Speak to record, 2.7 seconds recording time

[MENU] [ 8 ] > [Master code] > [ 4 ] > [ 1 ] [ENTER]



---

 [TALK]  [ENTER] Zone 1



---

 [TALK]  [ENTER] Zone 2



---

 [TALK]  [ENTER] Zone 3



---

 [TALK]  [ENTER] Zone 4



---

 [TALK]  [ENTER] Zone 5



---

 [TALK]  [ENTER] Zone 6

---

 [TALK]  [ENTER] Zone 7

---

 [TALK]  [ENTER] Zone 8

---

Touch [MENU] [MENU] to exit.

Copying recorded messages from one NX-181xx to another, requires the connection of the audio line between NX-181xx Voice keypads.

## Domestic dial phone numbers 1, 2 and 3:

[MENU] [ 6 ] > [Master code]

---

[ 1 ] [ Phone number one ] [ENTER] > [MENU]

---

[ 2 ] [ Phone number two ] [ENTER] > [MENU]

---

[ 3 ] [ Phone number three ] [ENTER] > [MENU]

---

Touch [MENU] [MENU] to exit.

# Word Library

1	One	39	Boat	77	Gun	115	Remote
2	Two	40	Cabinet	78	Hall	116	Roof
3	Three	41	Car park	79	Hallway	117	Room
4	Four	42	Ceiling	80	Heat	118	Rumpus
5	Five	43	Cellar	81	Heating	119	Safe
6	Six	44	Child's	82	Hold-up	120	Security
7	Seven	45	Alert	83	Home	121	Sensor
8	Eight	46	Closet	84	Home theatre	122	Shed
9	Nine	47	Computer	85	Infrared	123	Shock
10	Ten	48	Cool	86	Inside	124	Shop
11	Eleven	49	Curtain	87	Instant	125	Side
12	Twelve	50	Data	88	Interior	126	Skylight
13	Thirteen	51	Den	89	Key switch	127	Sliding
14	Fourteen	52	Detector	90	Keychain	128	Small
15	Fifteen	53	Dining	91	Kitchen	129	Smoke
16	Sixteen	54	Door	92	Large	130	South
17	Seventeen	55	Downstairs	93	Laundry	131	Stairs
18	Eighteen	56	Driveway	94	Lift	132	Storage
19	Nineteen	57	Duress	95	Light	133	Study
20	Twenty	58	East	96	Living	134	Temperature
21	Thirty	59	emergency	97	location	135	tennis
22	Forty	60	Exterior	98	Master	136	Toilet
23	Fifty	61	Family	99	Medicine	137	Training
24	Sixty	62	Fan	100	Meeting	138	T V
25	Seventy	63	Fence	101	Motion	139	Upstairs
26	Eighty	64	Fire	102	Night	140	User
27	Ninety	65	Forced, arm	103	North	141	Utility
28	Hundred	66	Foyer	104	Nursery	142	Volt
29	Thousand	67	Freezer	105	Office	143	Veranda
30	Air conditioner	68	Front	106	Output	144	Wall
31	Area	69	Games	107	Outside	145	Warehouse
32	Attic	70	Garage	108	Panic	146	Water
33	Automatic	71	Gas	109	Pantry	147	West
34	Auxiliary	72	Gate	110	Partial	148	Window
35	Back	73	Glass	111	Perimeter	149	Windows
36	Basement	74	Glass break	112	Pool	150	Wireless
37	Bathroom	75	Ground	113	Rear	151	Yard
38	Bedroom	76	Guest	114	Reception	152	Zone
						153	Gym



# Cable Requirements

## Panel bus

**Table 2: Maximum wire run**

Length in feet	Wire gauge when connected to panel	Wire gauge when connected to remote PSU
250	24	22
500	20	18
1000	18	16
1500	16	14
2500	14	12

These numbers are for one keypad at the end of the wire. When connecting more than one keypad to the end of the wire, a higher gauge wire or a reduction in total wire distance will be required. Star or daisy chain wiring configuration allowed.

## Audio line

A maximum of 8 NX-181xx Voice keypads can be configured as room stations for intercom functionality. Two pairs of twisted cable (4 conductors) are required for the audio line, one pair for audio line A and another for audio line B. Maximum total wire run is 100 meters using 2 x twisted pairs. Star or daisy chain wiring configuration allowed.

**Note:** Both the audio line and data bus can either be star or daisy chain wired.

**Note:** Additional power required pending total current draw of system.

Keypad	Partition Number							
	1	2	3	4	5	6	7	8
1	192	193	194	195	196	197	198	199
2	200	201	202	203	204	205	206	207
3	208	209	210	211	212	213	214	215
4	216	217	218	219	220	221	222	223
5	224	225	226	227	228	229	230	231
6	232	233	234	235	236	237	238	239
7	240	241	242	243	244	245	246	247
8	248	249	250	251	252	253	254	255

# Specifications

Voltage	12 VDC regulated
Current	(averaged over 200 ms)
maximum	140 mA
without voice	110 mA
Dimensions (W × H × D)	80 × 120 × 16 mm
Operating temperature	0 to 50°C
Shipping weight	100 g