





TruVision HD-TVI Series 4 PTZ Dome Camera Installation Guide

P/N 1073206-EN • REV D • ISS 31AUG17

Copyright	© 2017 United Technologies Corporation, Interlogix is part of UTC Climate, Controls & Security, a unit of United Technologies Corporation. All rights reserved.
Trademarks and patents	Trade names used in this document may be trademarks or registered trademarks of the manufacturers or vendors of the respective products.
Manufacturer	Interlogix 2955 Red Hill Avenue, Costa Mesa, CA 92626-5923, USA Authorized EU manufacturing representative: UTC Fire & Security B.V. Kelvinstraat 7, 6003 DH Weert, The Netherlands
Certification	  
FCC compliance	Class A: This equipment has been tested and found to comply with the limits for a Class A digital device, pursuant to part 15 of the FCC Rules. These limits are designed to provide reasonable protection against harmful interference when the equipment is operated in a commercial environment. This equipment generates, uses, and can radiate radio frequency energy and, if not installed and used in accordance with the instruction manual, may cause harmful interference to radio communications. Operation of this equipment in a residential area is likely to cause harmful interference in which case the user will be required to correct the interference at his own expense.
FCC conditions	This device complies with Part 15 of the FCC Rules. Operation is subject to the following two conditions: (1) This device may not cause harmful interference. (2) This Device must accept any interference received, including interference that may cause undesired operation.

ACMA compliance **Notice!** This is a Class A product. In a domestic environment this product may cause radio interference in which case the user may be required to take adequate measures.

Canada This Class A digital apparatus complies with CAN ICES-003 (A)/NMB-3 (A).

Cet appareil numérique de la classe A est conforme à la norme CAN ICES-003 (A)/NMB-3 (A).

European Union directives This product and - if applicable - the supplied accessories too are marked with "CE" and comply therefore with the applicable harmonized European standards listed under the EMC Directive 2014/30/EU, the RoHS Directive 2011/65/EU.



2012/19/EU (WEEE directive): Products marked with this symbol cannot be disposed of as unsorted municipal waste in the European Union. For proper recycling, return this product to your local supplier upon the purchase of equivalent new equipment, or dispose of it at designated collection points. For more information see: www.recyclethis.info.



2013/56/EU & 2006/66/EC (battery directive): This product contains a battery that cannot be disposed of as unsorted municipal waste in the European Union. See the product documentation for specific battery information. The battery is marked with this symbol, which may include lettering to indicate cadmium (Cd), lead (Pb), or mercury (Hg). For proper recycling, return the battery to your supplier or to a designated collection point. For more information see: www.recyclethis.info.

Contact information For contact information, see www.interlogix.com or www.utcssecurityproducts.eu.

Content

Introduction 3

Product overview 3

HD-TVI 1080P PTZ Dome Cameras 3

HD-TVI 1080P IR PTZ Dome Cameras 3

Installation 4

Installation environment 4

Package contents 5

Pendant/Wall HD-TVI PTZ dome 5

Surface/Flush HD-TVI PTZ dome 7

Pendant/Wall IR HD-TVI PTZ dome 9

Cable requirements 11

DIP switch settings 11

HD-TVI PTZ dome 11

IR pendant/wall mount HD-TVI PTZ dome 16

Terminal resistor settings (non-IR cameras only) 32

Camera description 34

IR illuminators 37

Mounting the outdoor HD-TVI PTZ dome 37

Mount the bracket on the wall 37

Mount the camera on the bracket 38

Flush mount the camera 41

Surface mount the camera 44

Using the camera with a TruVision recorder or another system 49

Specifications 50

TruVision Pendant/Wall HD-TVI PTZ camera 50

TruVision Surface/Flush HD-TVI PTZ Dome 50

TruVision Pendant/Wall IR HD-TVI PTZ Dome 51

Introduction

Product overview

This is the installation guide for TruVision HD-TVI Series 4 PTZ Dome Camera models:

HD-TVI 1080P PTZ Dome Cameras

- TVP-2401 (30X, Pendant/Wall mount, PAL)
- TVP-2402 (30X, Surface/Flush mount, PAL)
- TVP-4401 (30X, Pendant/Wall mount, NTSC)
- TVP-4402 (30X, Surface/Flush mount, NTSC)

HD-TVI 1080P IR PTZ Dome Cameras

- TVP-2403 (30X, Pendant/Wall mount, PAL)
- TVP-4403 (30X, Pendant/Wall mount, NTSC)

Installation

This section provides information on how to install the cameras.

Installation environment

When installing your product, consider these factors:

- **Electrical:** Install electrical wiring carefully. It should be done by qualified service personnel. Always use a CE certified power supply (24VAC) to power the camera. Do not overload the power cord or adapter.
- **Ventilation:** Ensure that the location planned for the installation of the camera is well ventilated.
- **Temperature:** Do not operate the camera beyond the specified temperature, humidity or power source ratings. Humidity is below 90%. For the outdoor cameras that feature built-in heaters, the operating temperature range is -30 to 65°C (-22 to 149°F)
- **Moisture:** Do not expose the camera to rain or moisture or try to operate it in wet areas. Turn the power off immediately if the camera is wet and ask a qualified service person for servicing. Moisture can damage the camera and also create the danger of electric shock.
- **Servicing:** Do not attempt to service this camera yourself. Any attempt to dismantle or remove the covers from this product will invalidate the warranty and may also result in serious injury. Refer all servicing to qualified service personnel.
- **Cleaning:** Do not touch the sensor modules with fingers. If cleaning is necessary, use a clean cloth with some ethanol and wipe the camera gently. If the camera will not

be used for an extended period of time, put on the lens cap to protect the sensors from dirt.

Package contents

Check the package and contents for visible damage. If any components are damaged or missing, do not attempt to use the unit; contact the supplier immediately. If the unit is returned, it must be shipped back in its original packaging.

Pendant/Wall HD-TVI PTZ dome

- Camera
- Installation manual

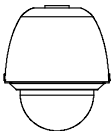

- CD with Configuration manual
- WEEE and Battery Disposal sheets

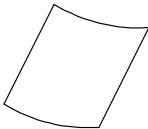
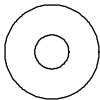

- Foam pad
(Place it at the top of the housing where the harness exits).



- Desiccant 1
(Two small bags. Used as the spare desiccant for the PTZ dome. To use this desiccant, place it inside the cup base and tie it with the zip tie below.)

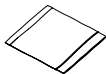

- Desiccant 2
(One large bag. Used to keep the two bags of desiccant away from moisture prior to use).

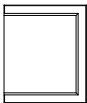

- Zip tie (X2)
(Used to tie the desiccant 1 bags inside the PTZ dome)



- Wrench (T20)

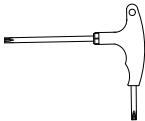

- Safety lanyard

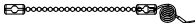

Surface/Flush HD-TVI PTZ dome

- Camera

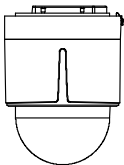

- CD with Configuration manual

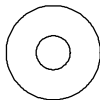

- Installation manual



- WEEE and Battery Disposal sheets

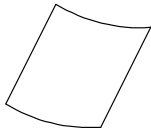

- Desiccant 1
(Two small bags. Used as the spare desiccant for the PTZ dome. To use this desiccant, place it inside the cup base and tie it with the zip tie below.)

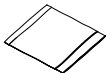

- Desiccant 2
(One large bag. Used to keep the two bags of desiccant away from moisture prior to use).

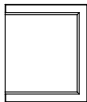

- Zip tie (2 pcs)
(Used to tie the desiccant
1 bags inside the PTZ
dome)



- housing ring

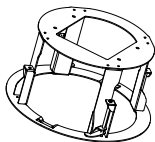

- Drill template (224 mm or
8.82 in.)



- Metal mounting base

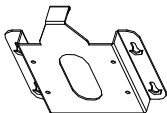

- Trim ring

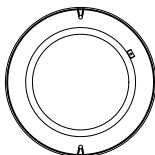

- Phillips screws (4
pcs)

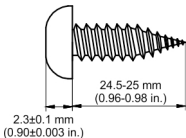

- Dry wall anchors (4 pcs)

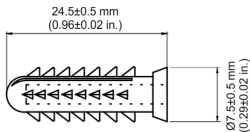

- Fixation pin (4 pcs)

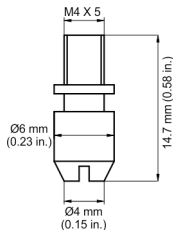

Pendant/Wall IR HD-TVI PTZ dome

- Camera

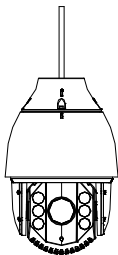

- CD with Configuration manual

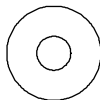

- Installation manual



- WEEE and Battery Disposal sheets

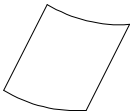

- Desiccant 1
(Two small bags. Used as the spare desiccant for the PTZ dome. To use this desiccant, place it inside the cup base and tie it with the zip tie below.)

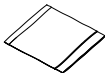

- Desiccant 2
(One large bag. Used to keep the two bags of desiccant away from moisture prior to use.)

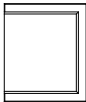

- Safety lanyard



- Wrench (M4)



CAUTION: Use direct plug-in UL listed power supplies marked Class 2/CE certified or LPS (limited power source) of the required output rating as listed on the unit.

CAUTION: Risk of explosion if the battery is replaced by an incorrect type. Dispose of used batteries according to the instructions.

Cable requirements

Choose the video cable according to the transmission distance. The minimum requirements for the coaxial video cable are:

- 75Ω impedance
- 100% copper core conducting wire
- 95% weaving copper shield
- RS-485 communication cable
- 24 VAC power cable

DIP switch settings

HD-TVI PTZ dome

For pendant/wall PTZ dome cameras, access the DIP switch by removing the rubber plugs on the two sides of the PTZ housing and unscrewing the two screws inside. Then open the bubble assembly, remove all three foam inserts and the plastic protective lens cover.

For surface/flush PTZ dome cameras, access the DIP switches by rotating the housing.

Use the DIP switch to set the address and baud rate for the PTZ dome. Value ON=1 and OFF=0.

Use the SW1 switches from the first to the eighth positions to set the address. Use the SW2 switches to set the baud rate.

Note: The default dome address is 0. The default baud rate is 2400.

Figure 1: DIP switch location for pendant/wall mount PTZ dome

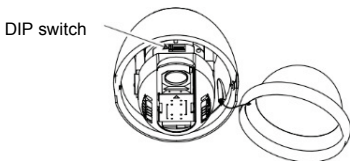

Figure 2: DIP switch location for surface/flush mount PTZ dome

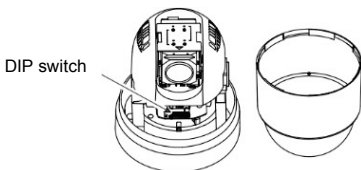

Figure 3: Enlarged view of the DIP switch



- **Address settings**

Use the SW1 switches from 1 to 4 to set the PTZ dome address. Refer to Table 1 on setting the PTZ dome address to a specific number.

Table 1: Set the dome address between 0 and 15

Dome address	Switch no.			
	1	2	3	4
0	OFF	OFF	OFF	OFF
1	ON	OFF	OFF	OFF
2	OFF	ON	OFF	OFF
3	ON	ON	OFF	OFF
4	OFF	OFF	ON	OFF
5	ON	OFF	ON	OFF
6	OFF	ON	ON	OFF
7	ON	ON	ON	OFF
8	OFF	OFF	OFF	ON
9	ON	OFF	OFF	ON
10	OFF	ON	OFF	ON
11	ON	ON	OFF	ON
12	OFF	OFF	ON	ON
13	ON	OFF	ON	ON
14	OFF	ON	ON	ON

Dome address	Switch no.			
	1	2	3	4
15	ON	ON	ON	ON

- **Protocol settings**

Use SW1 switches 5, 6 and 7 to set the PTZ dome protocol. Refer to Table 2 below:

Table 2: Set the dome protocol

Protocol	SW1 switch no.		
	5	6	7
UTC RS-485	OFF	OFF	OFF
PROTOCOL_PELCO_P	ON	OFF	OFF
PROTOCOL_PELCO_D	OFF	ON	OFF
PROTOCOL_DIGIPLEX	ON	ON	OFF
PROTOCOL_RS422_ASCII	OFF	OFF	ON
PROTOCOL_BOSCH_CODE	OFF	ON	ON
PROTOCOL_AD_CODE	ON	ON	ON

- **HD-TVI mode settings**

Use SW1 switch number 8 to set the HD-TVI mode of the PTZ dome. HD-TVI Mode 1.0 and HD-TVI Mode 2.0 are two standards to transfer HD-TVI signals. HD-TVI Mode 1.0 supports a short transmission distance with a wide bandwidth while HD-TVI Mode 2.0 supports a long transmission distance with a narrow bandwidth. Refer to the Table 3 below:

Table 3: Set the HD-TVI mode

HD-TVI mode	SW1 switch no.	
	8	
TVI 2.0	OFF	
TVI 1.0	ON	

- **Baud rate settings**

Use the SW2 switches 1 and 2 to set the baud rate of the PTZ dome. The baud rate can be 2400 bps, 4800 bps, 9600 bps or 19200 bps. The baud rate will be set as 2400 bps by default if it is out of this range. Refer to Table 4 below:

Table 4: Set the baud rate of the dome

Baud rate	SW2 switch no.	
	1	2
2400	OFF	OFF
4800	ON	OFF
9600	OFF	ON
19200	ON	ON

IR pendant/wall mount HD-TVI PTZ dome

Use the two DIP switches SW1 and SW2 to set the PTZ dome address, baud rate, protocol, etc. Value ON =1 and OFF =0. The switch label is on the back of the SWITCH cover, as shown below.

Each number of the switch represents a DIP value, ranging from 1 to 8 from the lowest to highest.

Figure 4: Label of DIP switch for pendant/wall mount HD-TVI IR PTZ dome

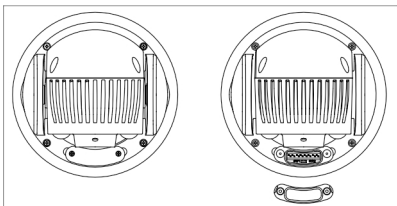

Figure 5: Enlarged view of the DIP switches



Note: The default dome address is 0. The default baud rate is 2400. The default value of the 120Ω terminator is OFF.

- **Address settings**

Use the SW1 switches to set the address of the PTZ dome. Refer to Table 5 below :

Table 5: Set the dome address

Dome address	Switch no.							
	1	2	3	4	5	6	7	8
0	OFF	OFF	OFF	OFF	OFF	OFF	OFF	OFF
1	ON	OFF	OFF	OFF	OFF	OFF	OFF	OFF
2	OFF	ON	OFF	OFF	OFF	OFF	OFF	OFF
3	ON	ON	OFF	OFF	OFF	OFF	OFF	OFF
4	OFF	OFF	ON	OFF	OFF	OFF	OFF	OFF
5	ON	OFF	ON	OFF	OFF	OFF	OFF	OFF
6	OFF	ON	ON	OFF	OFF	OFF	OFF	OFF
7	ON	ON	ON	OFF	OFF	OFF	OFF	OFF
8	OFF	OFF	OFF	ON	OFF	OFF	OFF	OFF
9	ON	OFF	OFF	ON	OFF	OFF	OFF	OFF
10	OFF	ON	OFF	ON	OFF	OFF	OFF	OFF
11	ON	ON	OFF	ON	OFF	OFF	OFF	OFF
12	OFF	OFF	ON	ON	OFF	OFF	OFF	OFF
13	ON	OFF	ON	ON	OFF	OFF	OFF	OFF
14	OFF	ON	ON	ON	OFF	OFF	OFF	OFF
15	ON	ON	ON	ON	OFF	OFF	OFF	OFF
16	OFF	OFF	OFF	OFF	ON	OFF	OFF	OFF
17	ON	OFF	OFF	OFF	ON	OFF	OFF	OFF
18	OFF	ON	OFF	OFF	ON	OFF	OFF	OFF
19	ON	ON	OFF	OFF	ON	OFF	OFF	OFF

Dome address	Switch no.							
	1	2	3	4	5	6	7	8
20	OFF	OFF	ON	OFF	ON	OFF	OFF	OFF
21	ON	OFF	ON	OFF	ON	OFF	OFF	OFF
22	OFF	ON	ON	OFF	ON	OFF	OFF	OFF
23	ON	ON	ON	OFF	ON	OFF	OFF	OFF
24	OFF	OFF	OFF	ON	ON	OFF	OFF	OFF
25	ON	OFF	OFF	ON	ON	OFF	OFF	OFF
26	OFF	ON	OFF	ON	ON	OFF	OFF	OFF
27	ON	ON	OFF	ON	ON	OFF	OFF	OFF
28	OFF	OFF	ON	ON	ON	OFF	OFF	OFF
29	ON	OFF	ON	ON	ON	OFF	OFF	OFF
30	OFF	ON	ON	ON	ON	OFF	OFF	OFF
31	ON	ON	ON	ON	ON	OFF	OFF	OFF
32	OFF	OFF	OFF	OFF	OFF	ON	OFF	OFF
33	ON	OFF	OFF	OFF	OFF	ON	OFF	OFF
34	OFF	ON	OFF	OFF	OFF	ON	OFF	OFF
35	ON	ON	OFF	OFF	OFF	ON	OFF	OFF
36	OFF	OFF	ON	OFF	OFF	ON	OFF	OFF
37	ON	OFF	ON	OFF	OFF	ON	OFF	OFF
38	OFF	ON	ON	OFF	OFF	ON	OFF	OFF
39	ON	ON	ON	OFF	OFF	ON	OFF	OFF
40	OFF	OFF	OFF	ON	OFF	ON	OFF	OFF

Dome address	Switch no.							
	1	2	3	4	5	6	7	8
41	ON	OFF	OFF	ON	OFF	ON	OFF	OFF
42	OFF	ON	OFF	ON	OFF	ON	OFF	OFF
43	ON	ON	OFF	ON	OFF	ON	OFF	OFF
44	OFF	OFF	ON	ON	OFF	ON	OFF	OFF
45	ON	OFF	ON	ON	OFF	ON	OFF	OFF
46	OFF	ON	ON	ON	OFF	ON	OFF	OFF
47	ON	ON	ON	ON	OFF	ON	OFF	OFF
48	OFF	OFF	OFF	OFF	ON	ON	OFF	OFF
49	ON	OFF	OFF	OFF	ON	ON	OFF	OFF
50	OFF	ON	OFF	OFF	ON	ON	OFF	OFF
51	ON	ON	OFF	OFF	ON	ON	OFF	OFF
52	OFF	OFF	ON	OFF	ON	ON	OFF	OFF
53	ON	OFF	ON	OFF	ON	ON	OFF	OFF
54	OFF	ON	ON	OFF	ON	ON	OFF	OFF
55	ON	ON	ON	OFF	ON	ON	OFF	OFF
56	OFF	OFF	OFF	ON	ON	ON	OFF	OFF
57	ON	OFF	OFF	ON	ON	ON	OFF	OFF
58	OFF	ON	OFF	ON	ON	ON	OFF	OFF
59	ON	ON	OFF	ON	ON	ON	OFF	OFF
60	OFF	OFF	ON	ON	ON	ON	OFF	OFF
61	ON	OFF	ON	ON	ON	ON	OFF	OFF

Dome address	Switch no.							
	1	2	3	4	5	6	7	8
62	OFF	ON	ON	ON	ON	ON	OFF	OFF
63	ON	ON	ON	ON	ON	ON	OFF	OFF
64	OFF	OFF	OFF	OFF	OFF	OFF	ON	OFF
65	ON	OFF	OFF	OFF	OFF	OFF	ON	OFF
66	OFF	ON	OFF	OFF	OFF	OFF	ON	OFF
67	ON	ON	OFF	OFF	OFF	OFF	ON	OFF
68	OFF	OFF	ON	OFF	OFF	OFF	ON	OFF
69	ON	OFF	ON	OFF	OFF	OFF	ON	OFF
70	OFF	ON	ON	OFF	OFF	OFF	ON	OFF
71	ON	ON	ON	OFF	OFF	OFF	ON	OFF
72	OFF	OFF	OFF	ON	OFF	OFF	ON	OFF
73	ON	OFF	OFF	ON	OFF	OFF	ON	OFF
74	OFF	ON	OFF	ON	OFF	OFF	ON	OFF
75	ON	ON	OFF	ON	OFF	OFF	ON	OFF
76	OFF	OFF	ON	ON	OFF	OFF	ON	OFF
77	ON	OFF	ON	ON	OFF	OFF	ON	OFF
78	OFF	ON	ON	ON	OFF	OFF	ON	OFF
79	ON	ON	ON	ON	OFF	OFF	ON	OFF
80	OFF	OFF	OFF	OFF	ON	OFF	ON	OFF
81	ON	OFF	OFF	OFF	ON	OFF	ON	OFF
82	OFF	ON	OFF	OFF	ON	OFF	ON	OFF

Dome address	Switch no.							
	1	2	3	4	5	6	7	8
83	ON	ON	OFF	OFF	ON	OFF	ON	OFF
84	OFF	OFF	ON	OFF	ON	OFF	ON	OFF
85	ON	OFF	ON	OFF	ON	OFF	ON	OFF
86	OFF	ON	ON	OFF	ON	OFF	ON	OFF
87	ON	ON	ON	OFF	ON	OFF	ON	OFF
88	OFF	OFF	OFF	ON	ON	OFF	ON	OFF
89	ON	OFF	OFF	ON	ON	OFF	ON	OFF
90	OFF	ON	OFF	ON	ON	OFF	ON	OFF
91	ON	ON	OFF	ON	ON	OFF	ON	OFF
92	OFF	OFF	ON	ON	ON	OFF	ON	OFF
93	ON	OFF	ON	ON	ON	OFF	ON	OFF
94	OFF	ON	ON	ON	ON	OFF	ON	OFF
95	ON	ON	ON	ON	ON	OFF	ON	OFF
96	OFF	OFF	OFF	OFF	OFF	ON	ON	OFF
97	ON	OFF	OFF	OFF	OFF	ON	ON	OFF
98	OFF	ON	OFF	OFF	OFF	ON	ON	OFF
99	ON	ON	OFF	OFF	OFF	ON	ON	OFF
100	OFF	OFF	ON	OFF	OFF	ON	ON	OFF
101	ON	OFF	ON	OFF	OFF	ON	ON	OFF
102	OFF	ON	ON	OFF	OFF	ON	ON	OFF
103	ON	ON	ON	OFF	OFF	ON	ON	OFF

Dome address	Switch no.							
	1	2	3	4	5	6	7	8
104	OFF	OFF	OFF	ON	OFF	ON	ON	OFF
105	ON	OFF	OFF	ON	OFF	ON	ON	OFF
106	OFF	ON	OFF	ON	OFF	ON	ON	OFF
107	ON	ON	OFF	ON	OFF	ON	ON	OFF
108	OFF	OFF	ON	ON	OFF	ON	ON	OFF
109	ON	OFF	ON	ON	OFF	ON	ON	OFF
110	OFF	ON	ON	ON	OFF	ON	ON	OFF
111	ON	ON	ON	ON	OFF	ON	ON	OFF
112	OFF	OFF	OFF	OFF	ON	ON	ON	OFF
113	ON	OFF	OFF	OFF	ON	ON	ON	OFF
114	OFF	ON	OFF	OFF	ON	ON	ON	OFF
115	ON	ON	OFF	OFF	ON	ON	ON	OFF
116	OFF	OFF	ON	OFF	ON	ON	ON	OFF
117	ON	OFF	ON	OFF	ON	ON	ON	OFF
118	OFF	ON	ON	OFF	ON	ON	ON	OFF
119	ON	ON	ON	OFF	ON	ON	ON	OFF
120	OFF	OFF	OFF	ON	ON	ON	ON	OFF
121	ON	OFF	OFF	ON	ON	ON	ON	OFF
122	OFF	ON	OFF	ON	ON	ON	ON	OFF
123	ON	ON	OFF	ON	ON	ON	ON	OFF
124	OFF	OFF	ON	ON	ON	ON	ON	OFF

Dome address	Switch no.							
	1	2	3	4	5	6	7	8
125	ON	OFF	ON	ON	ON	ON	ON	OFF
126	OFF	ON	ON	ON	ON	ON	ON	OFF
127	ON	ON	ON	ON	ON	ON	ON	OFF
128	OFF	OFF	OFF	OFF	OFF	OFF	OFF	ON
129	ON	OFF	OFF	OFF	OFF	OFF	OFF	ON
130	OFF	ON	OFF	OFF	OFF	OFF	OFF	ON
131	ON	ON	OFF	OFF	OFF	OFF	OFF	ON
132	OFF	OFF	ON	OFF	OFF	OFF	OFF	ON
133	ON	OFF	ON	OFF	OFF	OFF	OFF	ON
134	OFF	ON	ON	OFF	OFF	OFF	OFF	ON
135	ON	ON	ON	OFF	OFF	OFF	OFF	ON
136	OFF	OFF	OFF	ON	OFF	OFF	OFF	ON
137	ON	OFF	OFF	ON	OFF	OFF	OFF	ON
138	OFF	ON	OFF	ON	OFF	OFF	OFF	ON
139	ON	ON	OFF	ON	OFF	OFF	OFF	ON
140	OFF	OFF	ON	ON	OFF	OFF	OFF	ON
141	ON	OFF	ON	ON	OFF	OFF	OFF	ON
142	OFF	ON	ON	ON	OFF	OFF	OFF	ON
143	ON	ON	ON	ON	OFF	OFF	OFF	ON
144	OFF	OFF	OFF	OFF	ON	OFF	OFF	ON
145	ON	OFF	OFF	OFF	ON	OFF	OFF	ON

Dome address	Switch no.							
	1	2	3	4	5	6	7	8
146	OFF	ON	OFF	OFF	ON	OFF	OFF	ON
147	ON	ON	OFF	OFF	ON	OFF	OFF	ON
148	OFF	OFF	ON	OFF	ON	OFF	OFF	ON
149	ON	OFF	ON	OFF	ON	OFF	OFF	ON
150	OFF	ON	ON	OFF	ON	OFF	OFF	ON
151	ON	ON	ON	OFF	ON	OFF	OFF	ON
152	OFF	OFF	OFF	ON	ON	OFF	OFF	ON
153	ON	OFF	OFF	ON	ON	OFF	OFF	ON
154	OFF	ON	OFF	ON	ON	OFF	OFF	ON
155	ON	ON	OFF	ON	ON	OFF	OFF	ON
156	OFF	OFF	ON	ON	ON	OFF	OFF	ON
157	ON	OFF	ON	ON	ON	OFF	OFF	ON
158	OFF	ON	ON	ON	ON	OFF	OFF	ON
159	ON	ON	ON	ON	ON	OFF	OFF	ON
160	OFF	OFF	OFF	OFF	OFF	ON	OFF	ON
161	ON	OFF	OFF	OFF	OFF	ON	OFF	ON
162	OFF	ON	OFF	OFF	OFF	ON	OFF	ON
163	ON	ON	OFF	OFF	OFF	ON	OFF	ON
164	OFF	OFF	ON	OFF	OFF	ON	OFF	ON
165	ON	OFF	ON	OFF	OFF	ON	OFF	ON
166	OFF	ON	ON	OFF	OFF	ON	OFF	ON

Dome address	Switch no.							
	1	2	3	4	5	6	7	8
167	ON	ON	ON	OFF	OFF	ON	OFF	ON
168	OFF	OFF	OFF	ON	OFF	ON	OFF	ON
169	ON	OFF	OFF	ON	OFF	ON	OFF	ON
170	OFF	ON	OFF	ON	OFF	ON	OFF	ON
171	ON	ON	OFF	ON	OFF	ON	OFF	ON
172	OFF	OFF	ON	ON	OFF	ON	OFF	ON
173	ON	OFF	ON	ON	OFF	ON	OFF	ON
174	OFF	ON	ON	ON	OFF	ON	OFF	ON
175	ON	ON	ON	ON	OFF	ON	OFF	ON
176	OFF	OFF	OFF	OFF	ON	ON	OFF	ON
177	ON	OFF	OFF	OFF	ON	ON	OFF	ON
178	OFF	ON	OFF	OFF	ON	ON	OFF	ON
179	ON	ON	OFF	OFF	ON	ON	OFF	ON
180	OFF	OFF	ON	OFF	ON	ON	OFF	ON
181	ON	OFF	ON	OFF	ON	ON	OFF	ON
182	OFF	ON	ON	OFF	ON	ON	OFF	ON
183	ON	ON	ON	OFF	ON	ON	OFF	ON
184	OFF	OFF	OFF	ON	ON	ON	OFF	ON
185	ON	OFF	OFF	ON	ON	ON	OFF	ON
186	OFF	ON	OFF	ON	ON	ON	OFF	ON
187	ON	ON	OFF	ON	ON	ON	OFF	ON

Dome address	Switch no.							
	1	2	3	4	5	6	7	8
188	OFF	OFF	ON	ON	ON	ON	OFF	ON
189	ON	OFF	ON	ON	ON	ON	OFF	ON
190	OFF	ON	ON	ON	ON	ON	OFF	ON
191	ON	ON	ON	ON	ON	ON	OFF	ON
192	OFF	OFF	OFF	OFF	OFF	OFF	ON	ON
193	ON	OFF	OFF	OFF	OFF	OFF	ON	ON
194	OFF	ON	OFF	OFF	OFF	OFF	ON	ON
195	ON	ON	OFF	OFF	OFF	OFF	ON	ON
196	OFF	OFF	ON	OFF	OFF	OFF	ON	ON
197	ON	OFF	ON	OFF	OFF	OFF	ON	ON
198	OFF	ON	ON	OFF	OFF	OFF	ON	ON
199	ON	ON	ON	OFF	OFF	OFF	ON	ON
200	OFF	OFF	OFF	ON	OFF	OFF	ON	ON
201	ON	OFF	OFF	ON	OFF	OFF	ON	ON
202	OFF	ON	OFF	ON	OFF	OFF	ON	ON
203	ON	ON	OFF	ON	OFF	OFF	ON	ON
204	OFF	OFF	ON	ON	OFF	OFF	ON	ON
205	ON	OFF	ON	ON	OFF	OFF	ON	ON
206	OFF	ON	ON	ON	OFF	OFF	ON	ON
207	ON	ON	ON	ON	OFF	OFF	ON	ON
208	OFF	OFF	OFF	OFF	ON	OFF	ON	ON

Dome address	Switch no.							
	1	2	3	4	5	6	7	8
209	ON	OFF	OFF	OFF	ON	OFF	ON	ON
210	OFF	ON	OFF	OFF	ON	OFF	ON	ON
211	ON	ON	OFF	OFF	ON	OFF	ON	ON
212	OFF	OFF	ON	OFF	ON	OFF	ON	ON
213	ON	OFF	ON	OFF	ON	OFF	ON	ON
214	OFF	ON	ON	OFF	ON	OFF	ON	ON
215	ON	ON	ON	OFF	ON	OFF	ON	ON
216	OFF	OFF	OFF	ON	ON	OFF	ON	ON
217	ON	OFF	OFF	ON	ON	OFF	ON	ON
218	OFF	ON	OFF	ON	ON	OFF	ON	ON
219	ON	ON	OFF	ON	ON	OFF	ON	ON
220	OFF	OFF	ON	ON	ON	OFF	ON	ON
221	ON	OFF	ON	ON	ON	OFF	ON	ON
222	OFF	ON	ON	ON	ON	OFF	ON	ON
223	ON	ON	ON	ON	ON	OFF	ON	ON
224	OFF	OFF	OFF	OFF	OFF	ON	ON	ON
225	ON	OFF	OFF	OFF	OFF	ON	ON	ON
226	OFF	ON	OFF	OFF	OFF	ON	ON	ON
227	ON	ON	OFF	OFF	OFF	ON	ON	ON
228	OFF	OFF	ON	OFF	OFF	ON	ON	ON
229	ON	OFF	ON	OFF	OFF	ON	ON	ON

Dome address	Switch no.							
	1	2	3	4	5	6	7	8
230	OFF	ON	ON	OFF	OFF	ON	ON	ON
231	ON	ON	ON	OFF	OFF	ON	ON	ON
232	OFF	OFF	OFF	ON	OFF	ON	ON	ON
233	ON	OFF	OFF	ON	OFF	ON	ON	ON
234	OFF	ON	OFF	ON	OFF	ON	ON	ON
235	ON	ON	OFF	ON	OFF	ON	ON	ON
236	OFF	OFF	ON	ON	OFF	ON	ON	ON
237	ON	OFF	ON	ON	OFF	ON	ON	ON
238	OFF	ON	ON	ON	OFF	ON	ON	ON
239	ON	ON	ON	ON	OFF	ON	ON	ON
240	OFF	OFF	OFF	OFF	ON	ON	ON	ON
241	ON	OFF	OFF	OFF	ON	ON	ON	ON
242	OFF	ON	OFF	OFF	ON	ON	ON	ON
243	ON	ON	OFF	OFF	ON	ON	ON	ON
244	OFF	OFF	ON	OFF	ON	ON	ON	ON
245	ON	OFF	ON	OFF	ON	ON	ON	ON
246	OFF	ON	ON	OFF	ON	ON	ON	ON
247	ON	ON	ON	OFF	ON	ON	ON	ON
248	OFF	OFF	OFF	ON	ON	ON	ON	ON
249	ON	OFF	OFF	ON	ON	ON	ON	ON
250	OFF	ON	OFF	ON	ON	ON	ON	ON

Dome address	Switch no.							
	1	2	3	4	5	6	7	8
251	ON	ON	OFF	ON	ON	ON	ON	ON
252	OFF	OFF	ON	ON	ON	ON	ON	ON
253	ON	OFF	ON	ON	ON	ON	ON	ON
254	OFF	ON	ON	ON	ON	ON	ON	ON
255	ON	ON	ON	ON	ON	ON	ON	ON

- **Baud rate settings**

Use the SW2 switch numbers 1 and 2 to set the baud rate of the PTZ dome. The baud rate can be 2400 bps, 4800 bps, 9600 bps or 19200 bps. The baud rate will be set as 2400 bps by default if it is out of this range. Refer to Table 6 below:

Table 6: Set the baud rate of the dome

Baud rate	SW2 switch no.	
	1	2
2400	OFF	OFF
4800	ON	OFF
9600	OFF	ON
19200	ON	ON

- **Protocol settings**

Use SW2 switches numbers 3, 4 and 5 to set the PTZ dome protocol. Refer to Table 2 below:

Table 7: Set the dome protocol

Protocol	SW2 switch no.		
	3	4	5
UTC RS-485	OFF	OFF	OFF
PROTOCOL_PELCO_P	ON	OFF	OFF
PROTOCOL_PELCO_D	OFF	ON	OFF
PROTOCOL_DIGIPLEX	ON	ON	OFF
PROTOCOL_RS422_ASCII	OFF	OFF	ON
PROTOCOL_BOSCH_CODE	OFF	ON	ON
PROTOCOL_AD_CODE	ON	ON	ON

- **HD-TVI mode settings**

Use SW2 switch number 7 to set the HD-TVI mode of the PTZ dome. HD-TVI Mode 1.0 and HD-TVI Mode 2.0 are two standards to transfer HD-TVI signals. For HD-TVI Mode 1.0, it supports short transmission distance with wide bandwidth while for HD-TVI Mode 2.0, it supports long transmission distance with narrow bandwidth. Refer to Table 8 below:

Table 8: Set the HD-TVI Mode

	SW2 switch no.
HD-TVI mode	7
V2.0	OFF
V1.0	ON

- **Terminal resistor settings (IR cameras only)**

Use SW2 switch number 8 to turn on/off the 120Ω terminal resistor. When multiple PTZ domes are controlled through one RS-485 bus in serial mode, there must be a terminal resistor at the end of the RS-485 bus according to the RS-485 protocol standard. To ensure that the whole serial system operates normally, the PTZ dome at the end of the RS-485 bus needs to enable the terminal resistor.

Table 9: Set the terminal resistor

	SW2 switch no.
Terminal matching resistance	8
Turn on the resistor	ON
Turn off the resistor	OFF

Note: The O-ring in the groove of the switch cover is waterproof.

Terminal resistor settings (non-IR cameras only)

Follow these instructions to set the terminal resistor for the TVP-2401/TVP-4401.

1. Remove the bubble from the TVI PTZ dome.
2. Unscrew the four screws on the inside base of the camera to remove the PTZ drive from the housing.

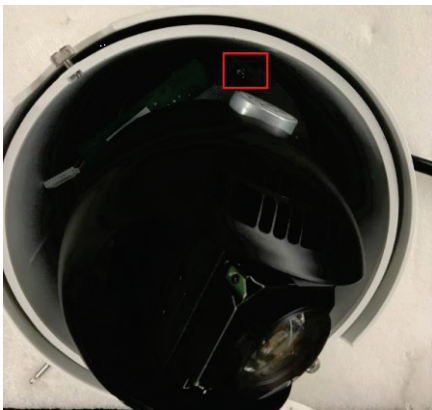

3. Locate the two pins near the corner of the dome drive base.

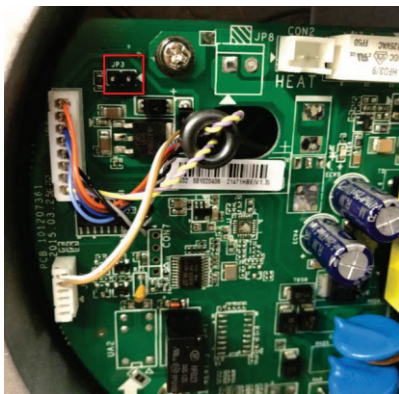

4. Turn on the terminal resistor by inserting a jumper wire to connect the two pins.

Camera description

Figure 6: Outdoor HD-TVI PTZ dome

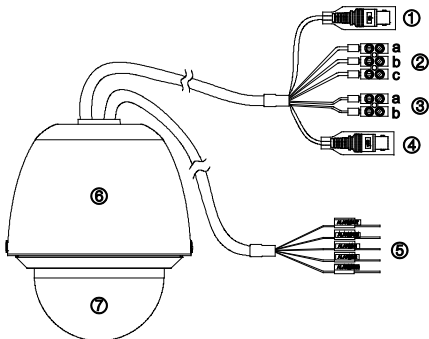

1. HD-TVI output (White)
2. Power supply
 - a. Black 24 VAC
 - b. Yellow/Green GND
 - c. Red 24 VAC
3. RS-485 port
 - a. Orange RS-485+
 - b. Yellow RS-485-
4. 960H analog output (Black)
5. 2 Alarm inputs (YELLOW/BLUE-ALARM_IN1, YELLOW/ORANGE-ALARM_IN2)/ 1 Alarm output (WHITE/RED-ALARM_OUT1)
6. Housing
7. Bubble

Figure 7: Indoor HD-TVI PTZ dome

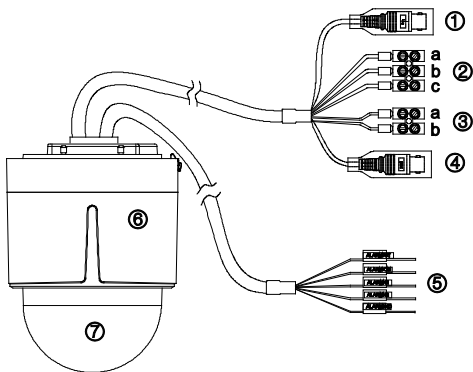

- | | |
|--|--|
| 1. HD-TVI output (White) | 4. 960H analog output (Black) |
| 2. Power supply
a. Black 24 VAC
b. Yellow/Green GND
c. Red 24 VAC | 5. 2 Alarm inputs (YELLOW/BLUE-ALARM_IN1, YELLOW/ORANGE-ALARM_IN2)/1 Alarm output (WHITE/RED-ALARM_OUT1) |
| 3. RS-485 port
a. Orange RS-485+
b. Yellow RS-485- | 6. Housing |
| | 7. Bubble |

Figure 8: IR outdoor HD-TVI PTZ dome

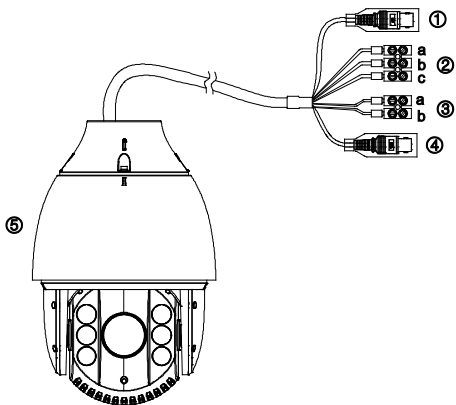

1. HD-TVI output (White)
2. Power supply
 - a. Black 24 VAC
 - b. Yellow/Green GND
 - c. Red 24 VAC
3. RS-485 port
 - a. Orange RS-485+
 - b. Yellow RS-485-
4. 960H analog output (Black)
5. Housing

IR illuminators

The IR PTZ dome camera's built-in IR illumination provides high-quality video in low-light environments, even when there is no other illumination available.

You can configure the IR illumination using the OSD menu or a recorder such as TVN and TVR. If the function is enabled, the IR light is ON when the camera enters night (black and white) mode. If disabled, the IR light is always OFF.

The visible IR range may vary due to multiple factors such as weather, IR reflection level of objects in the frame, lens adjustment, and camera settings. Please refer to the camera datasheet for the standard IR range.

Note: Avoid installing the IR camera in close proximity to a solid object, such as a tree or wall. The reflection will cause over-exposure and loss of detail in the field of view.

Mounting the outdoor HD-TVI PTZ dome

Mount the bracket on the wall

Wall mounting is suitable for indoor/outdoor solid wall construction. The following requirements are mandatory preconditions for wall mounting:

- The wall must be thick enough to install the expansion screws.
- Please ensure that the wall is strong enough to withstand more than eight times the weight of the dome and bracket.

To mount the bracket:

1. Remove the rubber plugs on the two sides of the PTZ housing.

2. Unscrew the two screws located below the rubber plugs.
3. Open the bubble assembly and remove all three foam inserts and the plastic protective lens cover.
4. Set the address and baud rate for the dome shown on the page 17.
5. Attach the safety cable to the bracket.

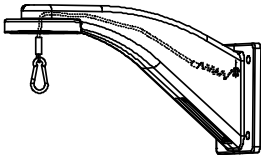

6. Use the supplied template to mark out the mounting area. Drill four screw holes in the wall according to the holes of the bracket, and then insert M8 expansion screws (not supplied) into the mounting holes.
7. Attach the bracket to the wall by aligning the four screw holes of the bracket with expansion screws on the wall.
8. Secure the bracket with four hex nuts and washers.

Mount the camera on the bracket

To mount the outdoor HD-TVI PTZ dome:

1. Hang the safety cable to the dome and then hook the dome to the bracket, as shown below.

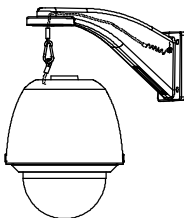

2. Route the cables from the pendant-mount bracket.
3. Install the PTZ dome to the bracket, and secure the PTZ dome using the screws enclosed with the bracket.

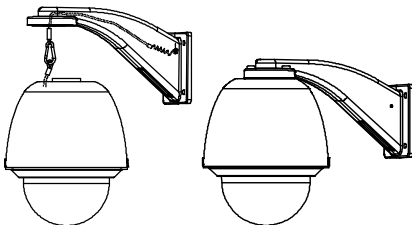

To mount the pendant/wall IR HD-TVI PTZ dome:

1. Set the address and baud rate for the dome shown on the page 17.
2. Hang the safety cable to the HD-TVI PTZ dome and then hook the dome to the bracket, as shown below.

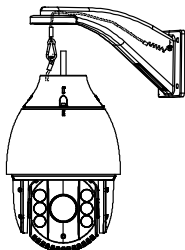

3. Route the cables of the PTZ dome through the bracket.
4. Connect the corresponding video/power/RS-485 cables.
5. Install the PTZ dome to the bracket, and secure the PTZ dome using the screws enclosed with the bracket.

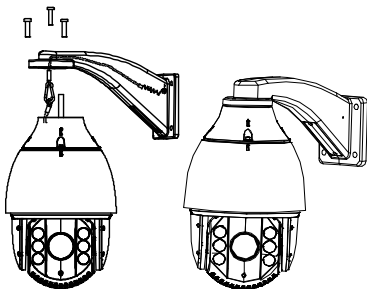

Flush mount the camera

Flush-mounting is suitable for indoor ceiling construction. The following requirements are mandatory preconditions for mounting:

- The height of the space above the ceiling must be greater than 250 mm (9.843 in).
- The thickness of the ceiling must be between 5 and 40 mm (0.197 to 1.575 in).
- The ceiling must be strong enough to withstand more than four times the weight of the dome and its accessories.

To mount the surface/flush HD-TVI PTZ dome flush with a ceiling:

1. Rotate the lower dome counterclockwise to separate it from the back box, as shown below.

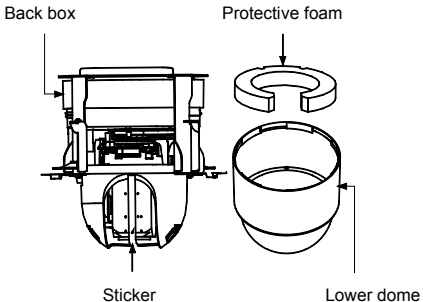

2. Remove the protective lens cover, foam and sticker from the dome drive.
3. Set the address and baud rate for the HD-TVI dome. See page 11.
4. Attach the lower dome to the back box. Rotate it clockwise to secure it.
5. Using the drill template, drill a hole on the ceiling.

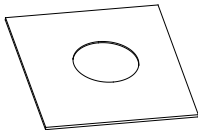

6. Connect the cables.

Make sure the video cable and control wire have been connected to the corresponding interfaces.

7. Adjust the height of the two housing tabs by turning the screw on which they are attached. The distance of the tabs from the housing ring must be greater than the thickness of the ceiling.

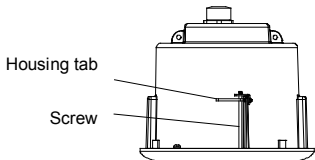

8. Make sure that the housing tab is closed and then PUSH the housing into the pass-through hole. Hold the housing and secure it by screwing the housing tabs down to the mounting surface.

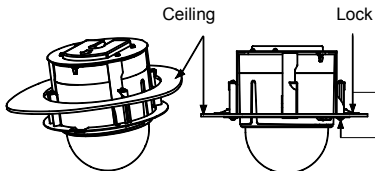

9. Install the trim ring.
- Attach the trim ring to the lower dome and align the triangular notch of the trim ring with the arrow label on the in-ceiling mounting bracket.
 - After firmly placing the trim ring on the ceiling, rotate the trim ring in the direction of arrow to secure the trim ring in place.

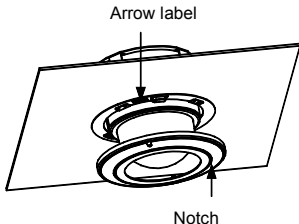

Note:

- Remove the protective film on the lower dome when the installation is completed.
- In order to obtain clear video images, wear anti-static gloves when you install the PTZ dome.

Surface mount the camera

Use surface mounting for indoor/outdoor solid ceiling construction. The following requirements are mandatory preconditions for mounting:

- The thickness of the ceiling must range from 5 to 40 mm (0.197 to 1.575 in).
- The ceiling must be strong enough to withstand more than four times the weight of the dome and its accessories.

To mount the surface/flush HD-TVI PTZ dome to a ceiling:

Note: When installing the PTZ to a ceiling, do not use drywall anchors.

1. Remove the mounting bracket.
 - A. Remove the four screws on the back box using a screwdriver.

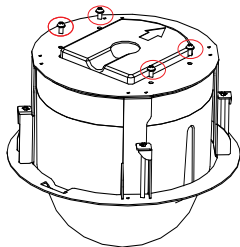

- B. Remove the in-ceiling mounting bracket.

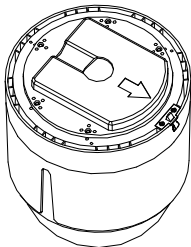

- C. Screw the four fixation pins onto the back box using a screwdriver.

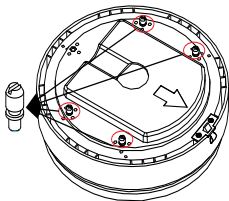

2. Wire the dome.

Route the cables of dome either from the top or the side of the back box. For the cables routed from the top of the back box, you must drill a cable hole in the ceiling.

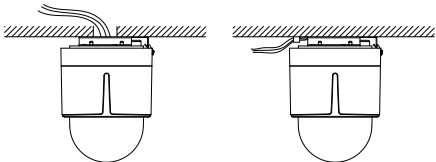

3. Surface mounting:
- Rotate the lower dome counterclockwise to separate it from the back box.
 - Remove the protective lens cover, foam and sticker from the dome drive.
 - Set the address and baud rate for the PTZ dome.
 - Attach the lower dome to the back box and rotate it clockwise to secure it.

- E. Use the mounting base as a template to mark four screw holes onto the ceiling.
- F. If you route cables from the top of the back box, mark the cable hole on the ceiling and drill a hole.

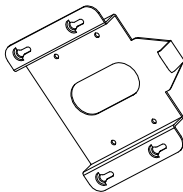

- G. Secure the mounting base to the ceiling with Phillips screws.
 - If the PTZ dome is installed onto a wooden wall, use the Phillips screws to secure the mounting base.
 - If the dome is installed onto the cement wall, drill four mounting holes, 5 mm in size, onto the mounting surface according to the hole locations. Then insert the cement screws (not included) into the holes and tighten.

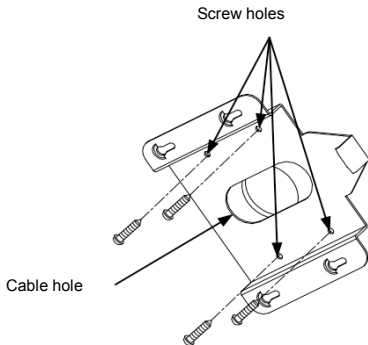

- H. Install the HD-TVI PTZ dome on to the mounting base.

Route the cables for the HD-TVI dome. Align the base of the HD-TVI dome with the mounting base.

Align the direction of the arrow with the spring end of the mounting base.

Push the HD-TVI dome upwards (1) and then forwards (2) in the direction of the arrow. When the HD-TVI dome is in position, the spring will automatically snap into the lock clip firmly. See the figure below:

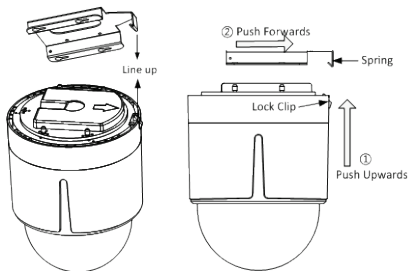

Note:

- Please remove the protective film on the lower dome after the installation is finished.
- Do not touch the bubble of the lower dome directly with your hand. The image will be blurred.

Using the camera with a TruVision recorder or another system

Please refer to the recorder user manual for instructions on connecting and operating the camera with these systems.

Specifications

TruVision Pendant/Wall HD-TVI PTZ camera

Electrical

Voltage input	24 VAC
---------------	--------

Power consumption	Max. 20 W
-------------------	-----------

Miscellaneous

Connectors	24 VAC, Alarm In/Out, HD-TVI Output, 960H Analog Output
------------	---

Operating temperature	-30 to +65 °C (-22 to +149°F)
-----------------------	-------------------------------

Dimensions	220 × 226 mm (8.66 × 10.5 in.)
------------	-----------------------------------

Weight	3 kg (6.61 lb.)
--------	-----------------

Environmental rating	IP66, IK10
----------------------	------------

TruVision Surface/Flush HD-TVI PTZ Dome

Electrical

Voltage input	24 VAC
---------------	--------

Power consumption	Max. 20 W
-------------------	-----------

Miscellaneous

Connectors	24 VAC, Alarm In/Out, HD-TVI Output, 960H Analog Output
------------	---

Operating temperature	-10 to +50 °C (14 to 122 °F)
Dimensions	Flush: 246 × 245 mm (9.69 × 9.65 in.) Surface: 179.8 × 239 mm (7.07 × 9.41 in.)
Weight	3 kg (6.61 lb.)
Environmental rating	IP54, IK10

TruVision Pendant/Wall IR HD-TVI PTZ Dome

Electrical

Voltage input	24 VAC
Power consumption	Max. 30 W

Miscellaneous

Connectors	24 VAC, HD-TVI Output, 960H Analog Output
Operating temperature	-30 to +65 °C (-22 to +149°F)
Dimensions	220 × 353.4 mm (8.66 × 13.91 in.)
Weight	4.5 kg (9.92 lb.)

