

# IFS WMC252-1W-1T-300 Quick Start Guide

## Content

- Package Contents 1
- Physical Introduction 1
- Hardware Installation 2
- Wired Network Connection (Windows 7) 2
- Web Management 3
- Wireless Network Connection **Error! Bookmark not defined.**
- More Information 3
- Contact information 3

This is the *IFS WMC252-1W-1T-300 Quick Start Guide*. This document provides basic instructions for installing and using the IFS WMC252-1W-1T-300.

## Package Contents

Thank you for choosing IFS WMC252-300. Before installing the AP, please verify the contents inside the box.

The WMC252-300 should contain the following items in the package:

- The IFS WMC252-1W-1T-300 x 1
- Quick Installation Guide x1
- PoE Injector and Power cord x1
- Plastic strap x 1

If any item is found missing or damaged, please contact your local reseller for replacement.

## Installation Precautions

1. Users **MUST** use a proper and well-installed surge arrester and grounding wired with the WMC252-300; otherwise, a sudden lightning could cause fatal damage to the WMC252-300. **(Lightning) DAMAGE IS NOT COVERED UNDER WARRANTY.**

2. Users **MUST** use the “Power cord and PoE Injector” shipped in the box with the WMC252-300. Use of other options will cause damage to the WMC252-300.

## Physical Introduction

### Rear Panel Description – LED Indications

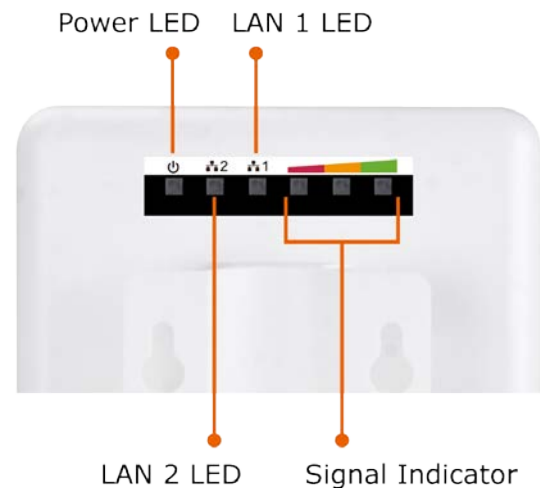

### Bottom Panel Description – Ports

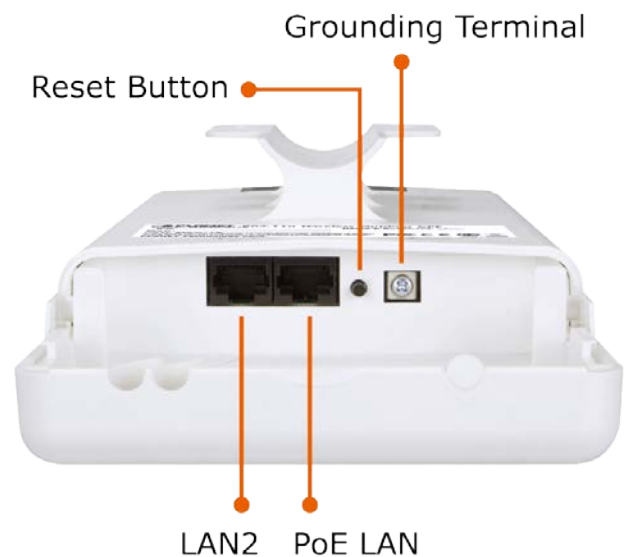

Reset: Press and hold the button for more than 10 seconds to reset to the factory default settings.

## Hardware Installation

Follow the steps below to install the WMC252:

1. Push the latch on the bottom of the WMC252-300 to remove the sliding cover.



2. Plug the RJ45 Ethernet cable into the PoE LAN Port of the WMC252-300. Then, slide back the cover of the WMC252-300 to finish the installation.

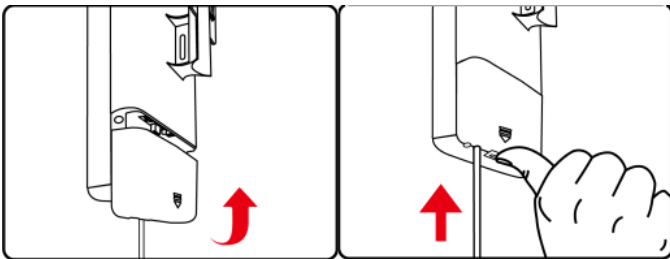

3. Plug the power cord into the DC port and the other side into the AC socket. Then, plug the RJ45 cable (as shown in picture 4 under Step 1) into the POE port of the PoE injector.

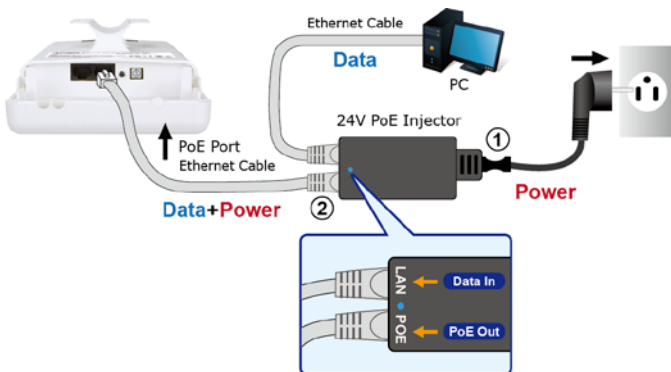

## Pole Mounting

Place the strap through the slot on the back of the WMC252-300 and then around the pole. Tighten the strap to secure the WMC252-300.



## Wired Network Connection (Windows 7)

Connect the WMC252-300 with your PC by an Ethernet cable plugging in LAN port of PoE injector in one side and in LAN port of PC in the other side. Power on the WMC252-300 by PoE from PoE injector.

1. Click **"Start"** button located at the lower-left corner of your computer.
2. Click **"Control Panel"**.
3. Double click **"Network and Sharing Center"** icon.
4. Click **"Change Adapter Settings"**.
5. Double click **"Local Area Connection"**.
6. Select **"Internet Protocol Version 4(TCP/IPv4)"** and click **"Properties"**.
7. Select **"Use the following IP address"** and then click **"OK"** button twice to save the configuration. For example, as the

default IP address of the WMC252-300 is 192.168.0.100 and the router is 192.168.0.254, you may choose from 192.168.0.1 to 192.168.0.252.

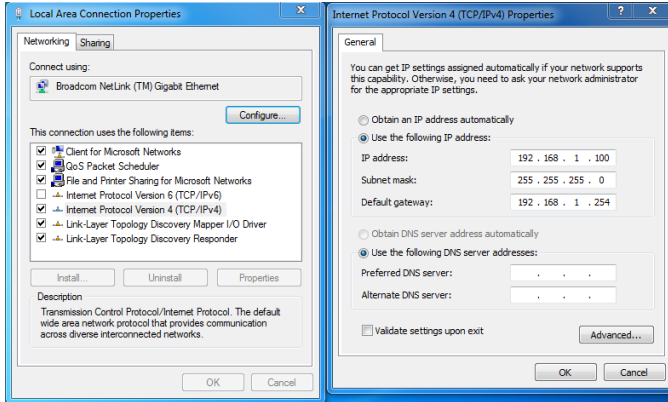

## Web Management

### Default Settings

- Default IP Address: **192.168.0.100**
- Default Username: **admin**
- Default Password: **admin**
- Default SSID: **WCM252-300**

The following steps show how to start up **Web Management** of the WMC252:

1. The Web management allows you to access and manage the Wireless AP easily. Launch the Web browser and enter the default IP address <http://192.168.0.100>.

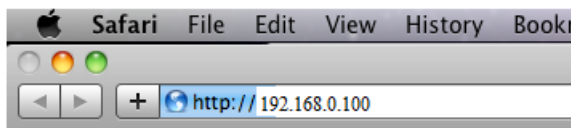
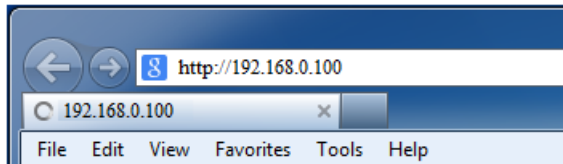

2. When the login window pops up, please enter the User Name and Password. The default User Name and Password are both "**admin**". Then click **OK** button to continue.



3. After you enter into the Web User Interface, go to **Wireless Basic Settings** to configure your wireless network. For security reasons, strongly recommended to configure the Encryption Method and Passphrase of your wireless network.

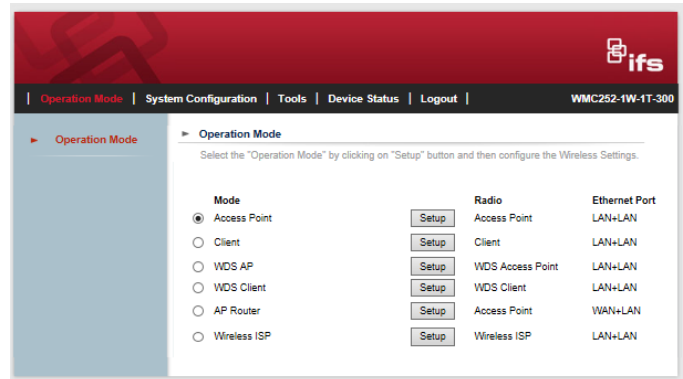

## More Information

The above steps introduce simple installations and configurations for the WMC252-300. For further configurations of LAN, Wireless, Access Control, etc, please refer to the user's manual in the CD. If you have further questions, please contact the local dealer or distributor where you purchased this product.

## Contact information

[www.interlogix.com](http://www.interlogix.com) or [www.utcssecurityproducts.eu](http://www.utcssecurityproducts.eu).

For customer support, see [www.interlogix.com/customer-support](http://www.interlogix.com/customer-support).

© 2015 United Technologies Corporation

Interlogix is part of UTC Climate Controls & Security, a unit of United Technologies Corporation. All rights reserved.