





TruVision DVR 42 User Manual

Copyright	© 2014 United Technologies Corporation. Interlogix is part of UTC Buildings & Industrial Systems, a unit of United Technologies Corporation. All rights reserved.
Trademarks and patents	Trade names used in this document may be trademarks or registered trademarks of the manufacturers or vendors of the respective products.
Manufacturer	Interlogix. 2955 Red Hill Avenue, Costa Mesa, CA 92626-5923, USA Authorized EU manufacturing representative: UTC Fire & Security B.V. Kelvinstraat 7, 6003 DH Weert, The Netherlands
Certification	  
FCC compliance	Class A: This equipment has been tested and found to comply with the limits for a Class A digital device, pursuant to part 15 of the FCC Rules. These limits are designed to provide reasonable protection against harmful interference when the equipment is operated in a commercial environment. This equipment generates, uses, and can radiate radio frequency energy and, if not installed and used in accordance with the instruction manual, may cause harmful interference to radio communications. Operation of this equipment in a residential area is likely to cause harmful interference in which case the user will be required to correct the interference at his own expense.
ACMA compliance	Notice! This is a Class A product. In a domestic environment this product may cause radio interference in which case the user may be required to take adequate measures.
Canada	This Class A digital apparatus complies with Canadian ICES-003. Cet appareil numérique de la class A conforme à la norme NMB-003 du Canada.
European Union directives	2004/108/EC (EMC directive): Hereby, UTC Climate Controls & Security declares that this device is in compliance or with the essential requirements and other relevant provisions of Directive 2004/108/EC.
 	2002/96/EC (WEEE directive): Products marked with this symbol cannot be disposed of as unsorted municipal waste in the European Union. For proper recycling, return this product to your local supplier upon the purchase of equivalent new equipment, or dispose of it at designated collection points. For more information see: www.recyclethis.info .
	2006/66/EC (battery directive): This product contains a battery that cannot be disposed of as unsorted municipal waste in the European Union. See the product documentation for specific battery information. The battery is marked with this symbol, which may include lettering to indicate cadmium (Cd), lead (Pb), or mercury (Hg). For proper recycling, return the battery to your supplier or to a designated collection point. For more information see: www.recyclethis.info .
Contact information	For contact information, see www.interlogix.com or www.utcssecurityproducts.eu

Content

Chapter 1	Product introduction 5
	Product overview 5
	Default settings to access the device 5
Chapter 2	Installation 7
	Installation environment 7
	Unpacking the TVR 42 and its accessories 7
	Back panel 8
	RS-485 ports 9
	RS-232 port 10
	Monitor connections 10
	Loop through 10
	Audio inputs and output 10
	Brackets 11
	PTZ dome camera set up 11
	Wiring the KTD-405 keypad 16
Chapter 3	Getting started 19
	Turning on and off the DVR 19
	Using the setup wizard 20
Chapter 4	Operating instructions 24
	Controlling the TVR 42 24
	Using the front panel 24
	Using the mouse 27
	Using the IR remote control 28
	Menu overview 30
Chapter 5	Live view 33
	Description of live view 33
	Video output 34
	Audio output 34
	Controlling live view 34
	Multiview format 36
	Sequencing cameras 37
	Accessing frequently used commands 37
	Configuring live view 39
	Configuring time and date 42
	General settings 43
	V-stream encoding 46
Chapter 6	Controlling a PTZ camera 47
	Configuring PTZ settings 47
	Calling up presets, preset tours and shadow tours 48

Setting and calling up presets 49
Setting and calling up preset tours 51
Setting and calling up a shadow tour 52

Chapter 7 **Playing back a recording 54**
Overview of the playback window 54
Playback pop-up menu 56
Instant playback 57
Previous-day playback 58
Searching recorded video 59
Playing back recordings by time and video type 60
Playing back recordings by event 61
Creating and playing back bookmarked recordings 62
Slideshow of snapshots 63
Playing back recordings from the system log 64
Playback skip time 65
Motion search 65
Playing back frame-by-frame 66
Digital zoom in playback 66

Chapter 8 **Archiving recorded files 67**
Archiving files 67
Auto archiving 70
Creating and archiving video clips 71
Archiving snapshots 72
Managing backup devices 72
Playing back archived files on a PC 72

Chapter 9 **Using the web browser 73**
Windows Vista and 7 users 73
Accessing the web browser 74
Web browser overview 74
Using the web browser to configure the device 76
Searching and playing back recorded video 80
Searching for event logs 82
Dual streaming 82
Controlling a PTZ dome camera in the web browser 84
Capturing text insertions 84
Text overlay 86
Using a network storage system 87

Chapter 10 **Recording 89**
Initializing recording settings 89
Defining a recording schedule 93
Daily schedules 94
Holiday schedules 95
Manual recording 95
Motion detection schedules 96

	External alarm schedules	96
	Protecting recorded files	96
	HDD redundancy	98
Chapter 11	Alarm settings	100
	Description of alarm notification types	100
	Setting up motion detection	103
	Setting up external alarms	106
	Triggering or clearing alarm outputs manually	108
	Setting up system notifications	108
	Detecting video loss	109
	Detecting video tampering	110
Chapter 12	Network settings	111
	Configuring general network settings	111
	Configuring PPPoE	112
	Configuring DDNS	113
	Configuring an NTP server	114
	Configuring e-mail	114
	Configuring UPnP	115
	Configuring SNMP	116
	Configuring an FTP server to store snapshots	116
	Configuring a remote alarm host	117
	Configuring multicast	117
	Configuring the server and HTTP ports	117
	Configuring the RTSP service port	118
	Checking network status	118
	Exporting network packet data	119
	Bandwidth throttle management	120
Chapter 13	HDD management	121
	Initializing HDDs	121
	Controlling disk space on the HDD	121
	Setting up HDD groups	122
	Recording dual streaming	123
	Setting the HDD property	123
	Checking HDD status	124
	Configuring HDD alarms	124
	Managing eSATA	125
	Checking the S.M.A.R.T. information	125
	Searching video using disk analysis	126
Chapter 14	Camera settings	128
	Configuring the camera OSD settings	128
	Setting up privacy masking	129
	Adjusting camera image settings	130
	Watermarking	130
	Hiding a camera image from view	130

Chapter 15	DVR management 132
	Configuring the RS-232 port 132
	Updating system firmware 133
	Restoring default settings 134
	Viewing system information 134
	Searching system logs for events 137
	Importing and exporting configuration settings 138
Chapter 16	User management 139
	Adding a new user 139
	Customizing a user's access privileges 140
	Deleting a user 142
	Modifying a user 142
	Changing the Admin password 142
Appendix A	Specifications 143
Appendix B	PTZ protocols 145
Appendix C	Port forwarding information 146
Appendix D	KTD-405 keypad 148
	Supported firmware 148
	Wiring the keypad 148
	Setting up the keypad to work with the TVR 42 149
	Operating the keypad 151
Appendix E	Maximum pre-recording times 156
Appendix F	Supported PTZ commands 158
Appendix G	Default menu settings 160
	Index 171

Chapter 1

Product introduction

Product overview

The TruVision™ DVR 42 (TVR 42) is a versatile, user-friendly embedded digital video recorder (DVR) allowing end-users to record 4, 8, or 16 analog cameras at 960h in real time (25/30 fps), while providing integration with the UTC portfolio of security solutions, and offering a seamless product experience within the TruVision brand.

Its dual streaming functionality allows the user to set up different settings for recording and streaming video in live view mode.

TruVision DVR 42 can fully integrate with the license-free TruVision Navigator software, which is ideal for the most commercial applications. TVR 42's easy and intuitive-to-use web browser interface enables remote configuration and secure viewing, searching, and playing back of video from computers connected via the Internet.

Note: Models are shipped with the power chords for their region.

Default settings to access the device

Default user names and passwords

See Table 2 below for the list of default user names and passwords. Go to Chapter 16 “User management” on page 139 for further information.

Table 1: Default user names and passwords

User	Description
Administrator	There can only be one administrator. The user name is admin. The name cannot be modified. The default password is 1234.
Operator	The default user name is “operator”. The default password is 2222.

User	Description
Guest	The default user name is "guest". The default password is 3333.

Note: The default passwords should be changed for security reasons.

Default network settings

The default values for TVR 42 network settings are:

- IP address - 192.168.1.82
- Subnet mask - 255.255.255.0
- Gateway address - 192.168.1.1
- Ports:

When using the browser:

RTSP port: 554

HTTP port: 80

When using TruNav:

RTSP port: 554

Server/Client software port: 8000

Go to Chapter 9 "Using the web browser" on page 73 for further information.

Chapter 2

Installation

This section describes how to install the TVR 42 unit.

Installation environment

When installing your product, consider these factors:

- Ventilation
- Temperature
- Moisture
- Chassis load

Ventilation: Do not block any ventilation openings. Install in accordance with the manufacturer's instructions. Ensure that the location planned for the installation of the unit is well ventilated.

Temperature: Consider the unit's operating temperature (-10 to +55 °C, 14 to 131 °F) and noncondensing humidity specifications (10 to 90%) before choosing an installation location. Extremes of heat or cold beyond the specified operating temperature limits may reduce the life expectancy of the DVR. Do not install the unit on top of other hot equipment. Leave 44 mm (1.75 in.) of space between rack-mounted TruVision DVR 42 units.

Moisture: Do not use the unit near water. Moisture can damage the internal components. To reduce the risk of fire or electric shock, do not expose this unit to rain or moisture.

Chassis: Equipment weighing less than 15.9 kg (35 lb.) may be placed on top of the unit.

Unpacking the TVR 42 and its accessories

When you receive the product, check the package and contents for damage, and verify that all items are included. There is an item list included in the package. If any of the items are damaged or missing, please contact your local supplier.

Items shipped with the product include:

- IR (infrared) remote control
- Two AAA batteries for the remote control
- AC power cords (US, Europe, UK)
- USB mouse
- TVR 42
- Video loop through cable
- CD with software and manuals
- TruVision DVR 42 Quick Start Guide
- TruVision DVR 42 User Manual (on CD)
- TruVision Recorder Operator Guide (on CD)

Back panel

Figure 1 on page 9 shows the back panel connections and describes each connector on a typical TVR 42 digital video recorder. Details may vary for specific models.

Before powering up the DVR, connect the cameras and a main monitor for basic operation.

Figure 1: Back panel connections

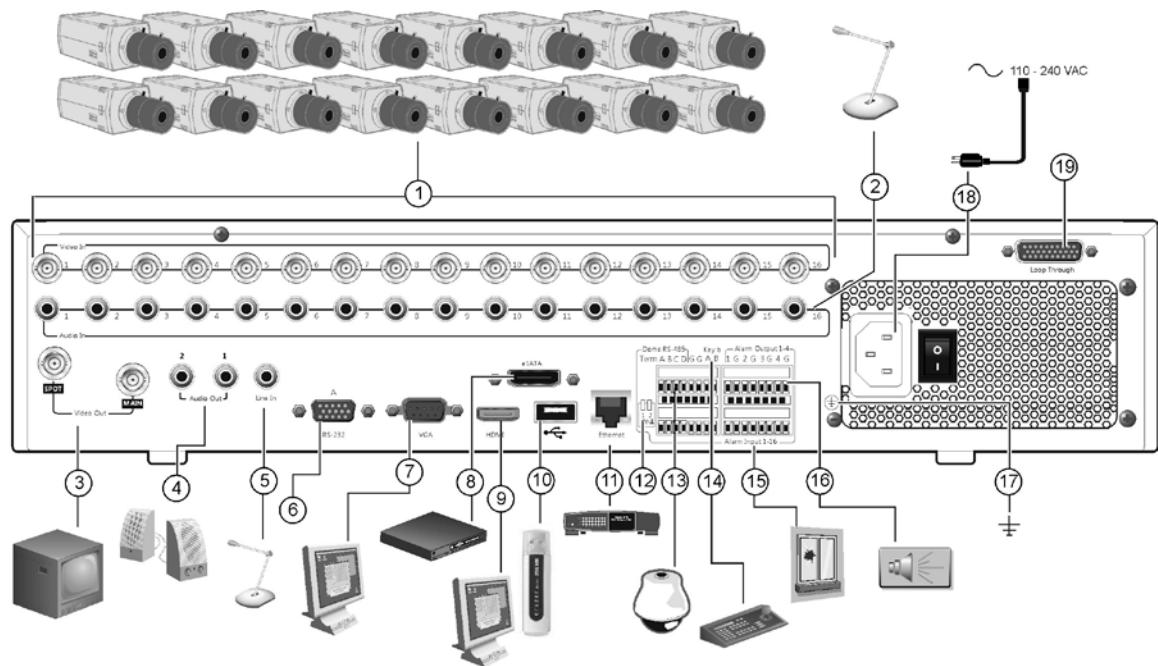

1. Connect up to 16 analog cameras to BNC connectors (depends on the DVR model).
2. Connect audio inputs (available for each camera) to RCA connectors.
3. Connect up to two CCTV monitors (BNC-type connectors):
 - Spot monitor
 - Main monitor
4. Connect to speakers for audio output.
5. Connect RCA connector to a microphone.
6. Connect to a RS-232 device.
7. Connect one CCTV monitor (BNC-type connector).
8. Connect to an optional eSATA device such as SATA HDD, CD/DVD-RM.
9. Connect to a HDTV. The HDMI connection supports both digital audio and video.
10. Connect to an optional USB device such as a mouse, CD/DVD burner or HDD. The DVR supports both a USB DVD and a USB HD on the front and back USB ports.
11. Connect to a network.
12. Terminate the line to the dome cameras using this RS-485 switch. Default is Off.
13. Connect to a PTZ control.
14. Connect to a keyboard (KTD-405 shown)
15. Connect up to 16 alarm inputs.
16. Connect up to four alarm relay outputs.
17. Connect to ground.
18. Connect to a power supply.
19. Loop through for up to 16 analog cameras (see item 1).

RS-485 ports

There are two RS-485 ports on the back panel of the DVR. See Figure 2 on page 10 for the serial pin outs.

- **Dome RS-485:**

A and B: Connect pan, tilt, zoom control of PTZ dome cameras. A = +, B = -

C and D: Not used

G: Ground of dome camera

G: Ground of keypad

- **Keyb:** Connect the keypad.

Figure 2: RS-485 pins

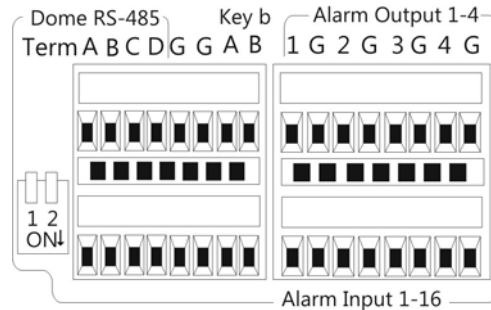

RS-232 port

Use the RS-232 port to connect CBR-PB3-POS (point-of-sale) and ATM devices to the DVR. See “Configuring the RS-232 port” on page 132 to configure the port.

Monitor connections

Connect the monitors to the DVR outputs (BNC/VGA/HMDI). The HDMI version is 1.3. The unit provides a 1 Vp-p analog signal. See Figure 1 on page 9 for connecting a monitor to a TVR 42.

The TVR 42 supports up to 1280 × 1024 / 60 Hz resolution in VGA. The monitor resolution should be at least 800 × 600. Adjust your monitor accordingly to this resolution.

Loop through

You can loop through the cameras to equipment such as a matrix, monitors or a second DVR. There are 16 numbered loop-through BNC outputs. See Figure 1 on page 9.

Audio inputs and output

The unit is equipped with 16 audio inputs and two audio outputs. Both the audio output and the audio inputs are line-level. Each 16 audio input is associated with one of the 16 cameras.

Audio input	RCA jack, 315 mV, 40 kohms. Unbalanced
Audio output	RCA jack, 315mV, 600 ohms. Unbalanced

Note: Line-level audio requires amplification.

Brackets

The DVR is easily rack-mountable with the purchase of the TVR-RK-1 rack-mount kit. See Figure 3 below. Contact your local supplier to order it.

Figure 3: Rack-mount installation

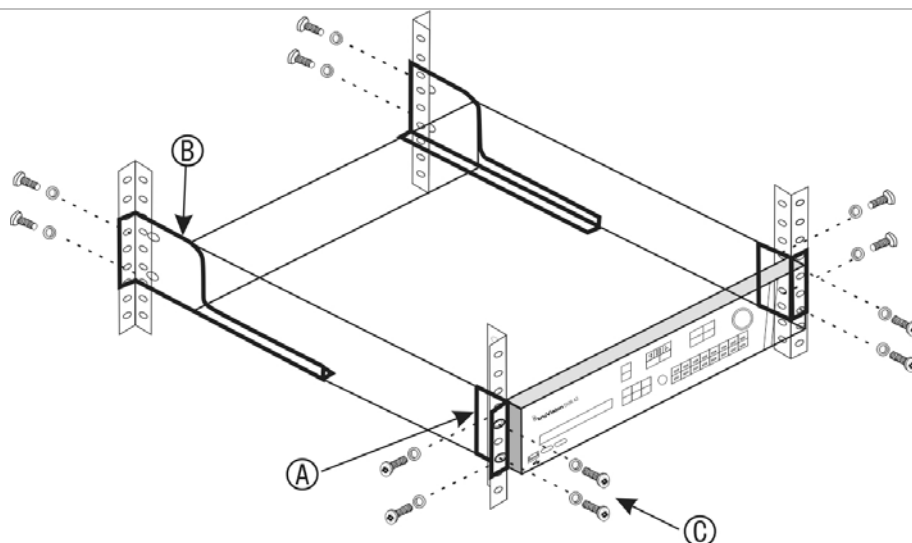

To install the racks:

1. Attach the two small front-rack mount ears to the DVR (A). The screws are supplied.
2. Attach the two large rear support brackets (not supplied) to the rear rails (B).
3. Attach the DVR to the front rails (C). The screws are not supplied.

Caution:

Do not rack-mount the TVR 42 without the rear rails installed. Failure to install the rear rails can damage the DVR.

PTZ dome camera set up

Use the USB mouse provided or the optional keypad for local telemetry control. If using the TVR 42 over a network, use the web browser to control the PTZ dome cameras or TruVision Navigator.

See Appendix B on page 145 for the supported protocols and Appendix F on page 158 for the PTZ commands supported by each protocol.

Each PTZ camera must be set up individually. For information on configuring PTZ dome camera settings, see Chapter 6, “Controlling a PTZ camera” on page 47.

Connecting a TVR 42 to a PTZ dome camera and a keypad

You can connect the KTD-405 or TVK-800 keypad to the DVR. The KTD-405 is a RS-485 bus keypad and the TVK-800 is an IP keypad.

For information on using the TVK-800 keypad, please refer to the TVK-800 user manual.

When connecting the KTD-405 keypad, use the input/output box that is supplied with the keypad to connect a keypad to the TVR 42. The keypad can be connected to a PTZ camera for local control or for control over the network.

See Figure 4 below for the preferred setup. Any PTZ dome camera can be controlled as the DVR is doing the PTZ protocol translation. However, this setup provides only limited dome configuration.

Figure 4: Connecting a KTD-405 keypad to the TVR 42 for control of a PTZ dome camera over the network

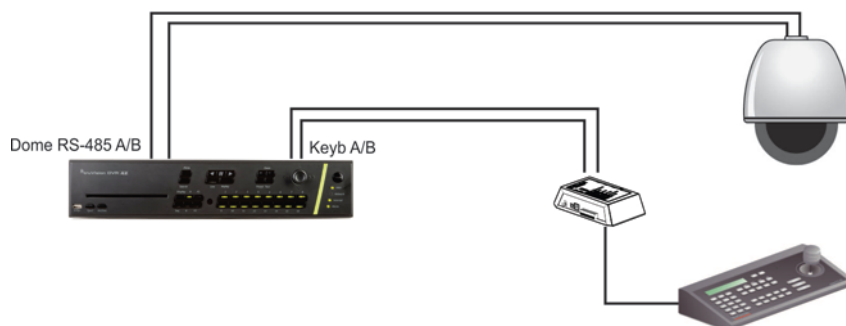

Configuring the PTZ protocols for Interlogix cameras

Before the PTZ dome cameras are assembled in their housings, set their protocol and address DIP switches for the TVR 42. See Table 3 on page 13 for different Interlogix PTZ dome camera settings.

If you are using PTZ dome cameras from another company, please refer to their configuration instructions.

Table 2: PTZ protocols for Interlogix cameras

Camera	Switch setting
TruVision Mini PTZ 12X: Indoor Dome	Protocol DIP switches: 000000
	RS-485 communication DIP switches: 0000000000
	Camera ID DIP switches: Select the camera ID DIP switch address as required

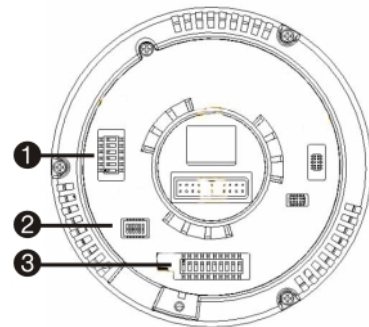

1. Protocol DIP switches
2. RS-485 communication DIP switches
3. Camera ID DIP switches

RS-485 data connector:

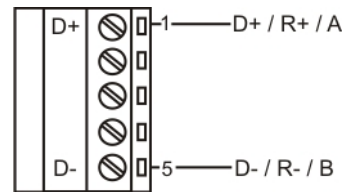

TruVision Mini PTZ 12X: Outdoor Dome	Protocol DIP switches: 000000
	RS-485 communication DIP switches: 0000000000
	Camera ID DIP switches: Select the camera ID DIP switch address as required.

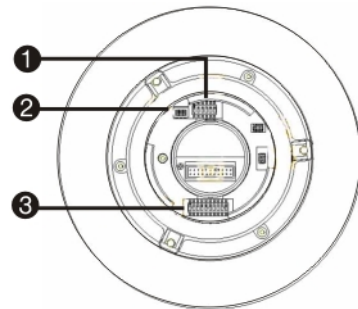

1. Protocol DIP switches
2. RS-485 communication DIP switches
3. Camera ID DIP switches

RS-485 data connector:

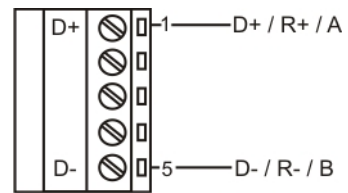

Camera	Switch setting
TruVision Dome 16X PTZ	Protocol switches: 0111
	Address switches: Select the camera ID DIP switch address as required.
	Baud rate: 0000



1. Address switches; 2. Baud switches;
3. Protocol switches

RS-485 data connector:

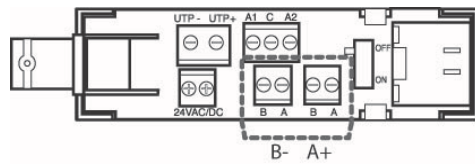

CyberDome	Protocol switches: NA
	Address switches: Select the camera ID DIP switch address as required.

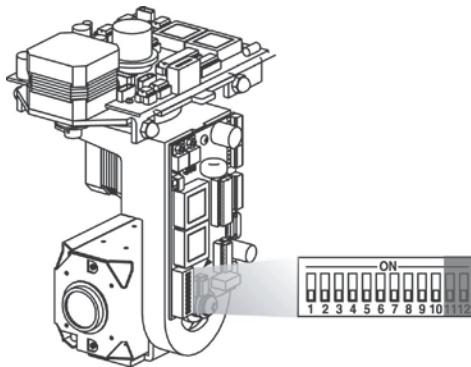

RS-485 data connector:

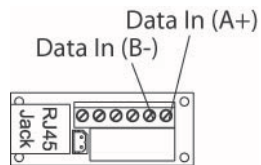

Camera	Switch setting
UltraView PTZ	Protocol switches: 01000 Address switches: Select the switch address as required.

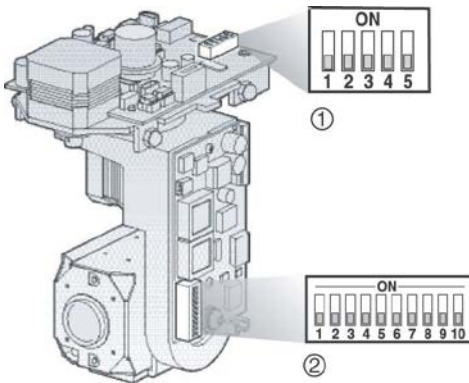

1. Protocol switches;
2. Address switches

RS-485 data connector:

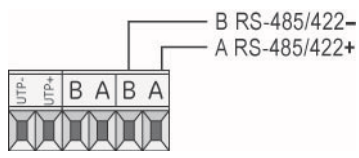

Legend	Switch setting
	Protocol switches: 1
	Address switches: Select the camera ID DIP switch address as required.

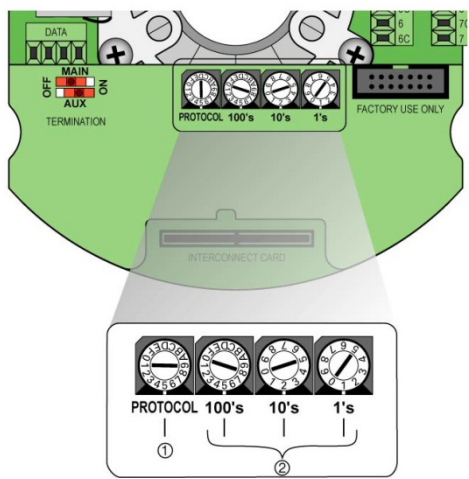

RS-485 data connector:

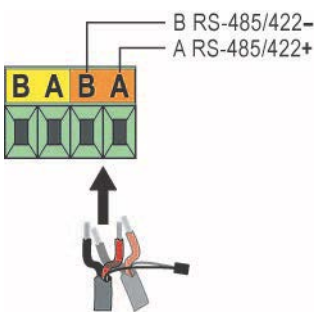

Wiring the KTD-405 keypad

The KTD-405 keypad uses RS-485 simplex wiring. The signal is transferred by a single twisted pair line. A shielded STP CAT5 network cable is recommended. Ground one end of the cable, either the first or last device on the RS-485 line.

The maximum number of devices that can be installed in one bus is 255, with a maximum cable length of 1200 m. The cable length can be expanded using a signal distributor.

Both the first and the last device in series should be terminated with 120 Ohm resistance to minimize line reflections. See Figure 5 below.

Figure 5: RS-485 bus serial wiring

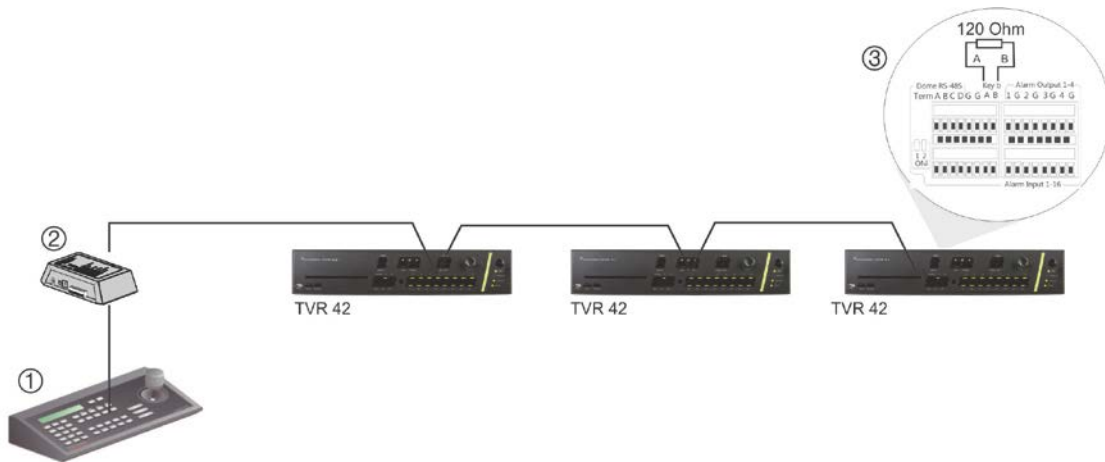

- 1. Keypad (KTD-405 keypad shown)
- 2. I/O box

- 3. See section "RS-485 ports" on page 9

Use an RS-485 signal distributor for a star wiring configuration. See Figure 6 on page 17.

Figure 6: Star wiring with RS-485 signal distributor

Correct:

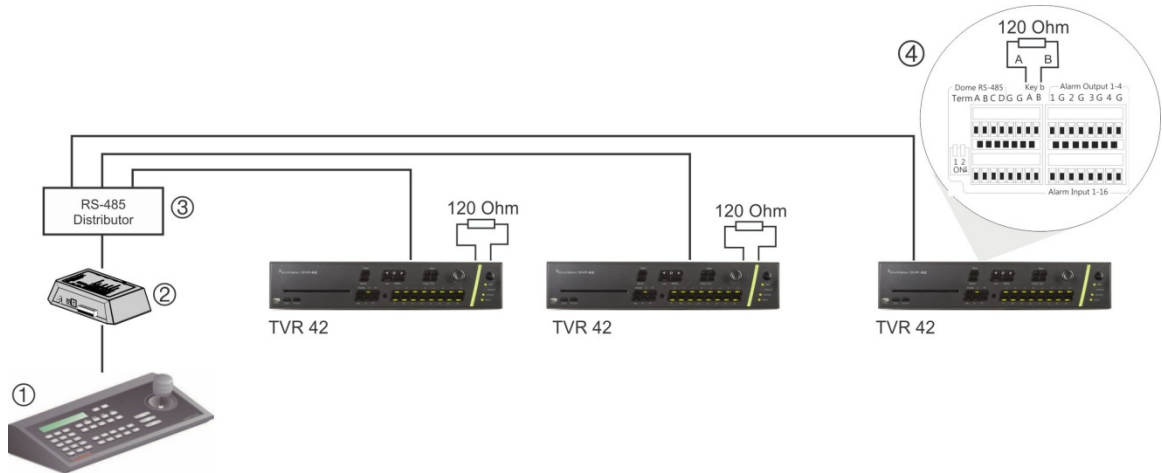

- 1. Keypad (KTD-405 keypad shown)
- 2. I/O box

- 3. RS-485 distributor
- 4. See section “RS-485 ports” on page 9

Incorrect:

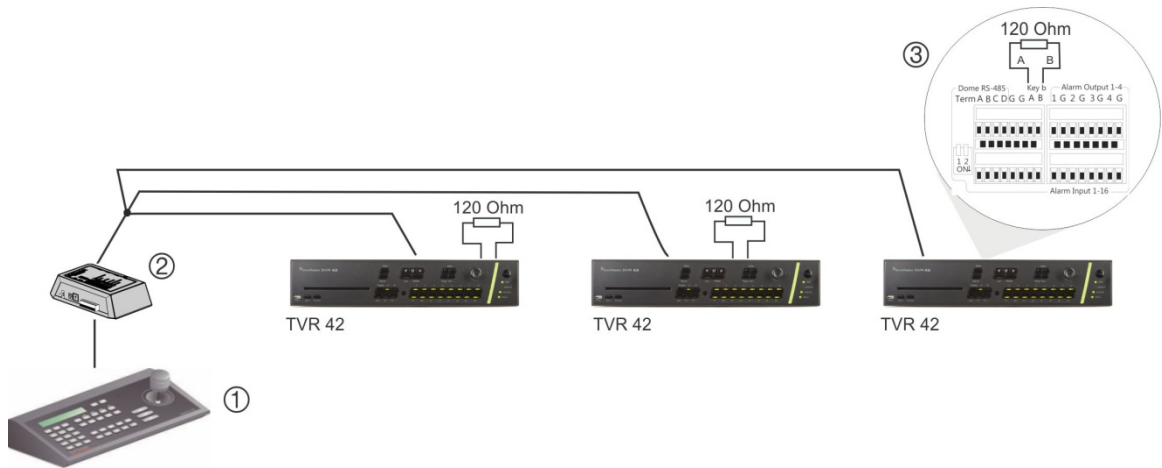

- 1. Keypad (KTD-405 keypad shown)
- 2. I/O box

- 3. See section “RS-485 ports” on page 9

Use an RS-485 signal distributor to increase the maximum number of devices on the bus as well as the total range. Each distributor output provides another RS-485 bus, extending the output an additional 1200 m. Up to 31 TVR 42s can be connected to each output. See Figure 7 on page 18.

Figure 7: Expanding the system with an RS-485 signal distributor

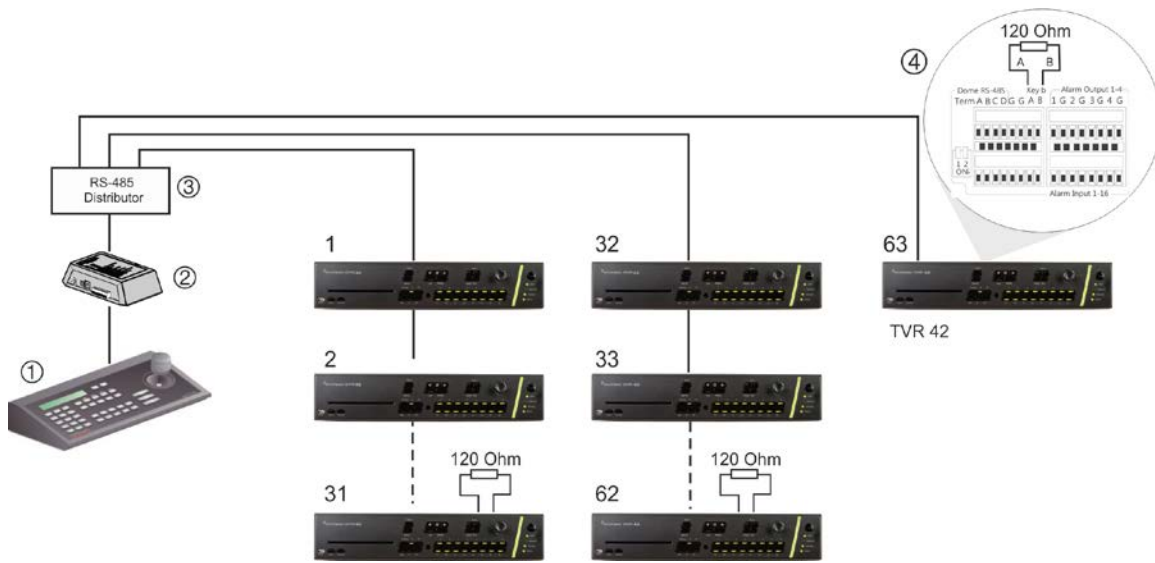

- 1. Keypad (KTD-405 keypad shown)
- 2. I/O box

- 3. RS-485 distributor
- 4. See section “RS-485 ports” on page 9

Caution: Most signal distributors are unidirectional. This means that the signal only flows from the input towards the outputs. Consequently it is not possible to connect several keypads.

See section “RS-485 ports” below to configure the RS-485 port communication settings.

Chapter 3

Getting started

Turning on and off the DVR

Before starting the power up process, connect at least one monitor to the BNC, HDMI, or VGA outputs. Otherwise, you will not be able to see the user interface and operate the device. Also connect at least one camera.

The DVR auto-detects the video mode (PAL or NTSC) on startup.

It is equipped with a universal power supply that will auto-sense 110/240 V, 60/50 Hz.

Note: It is recommended that an uninterruptible power supply (UPS) is used in conjunction with the device.

To turn on the DVR:

Turn on the DVR using the power switch on the back panel. A splash screen appears on screen.

Once the TVR 42 is powered up, the indicator bar on the front panel will light up green. All connected cameras are displayed on-screen. The TVR 42 automatically begins recording.

To turn off the DVR:

1. In live view mode, right-click the mouse and click **Menu**. The main menu window appears.
2. Select the **Power Manager** icon.
3. In the Shutdown popup menu, select **Shutdown**. Click **Yes** to confirm shutdown.

To reboot the DVR:

1. In live view mode, right-click the mouse and click **Menu**. The main menu window appears.
2. Select the **Power Manager** icon.
3. In the Shutdown popup menu, select **Reboot**. Click **Yes** to confirm shutdown.

Using the setup wizard

The TVR 42 has an express installation wizard that lets you easily configure basic DVR settings when first used. It configures all cameras simultaneously. The configuration can then be customized as required.

By default the setup wizard will start once the DVR has loaded. It will walk you through some of the more important settings of your DVR.

Any changes you make to a setup configuration page are saved when you exit the page and return to the main wizard page.

Note: If you want to set up the DVR with default settings only, click **Next** in each window until the end.

To quickly set up the DVR:

1. Connect all the devices required to the back panel of the DVR. See Figure 1 on page 9.
2. Turn on the unit using the power switch on the back panel. After the boot up window, the DVR displays video images on screen.
3. Select the preferred language for the system from the dropdown list and then click **Next**.
4. Enable or disable the option to start the wizard automatically when the DVR is turned on. Click **Next**.

5. Administrator configuration:

Navigate to the Admin Password edit box and click the edit box with the mouse, or press Enter on the front panel or remote control, to display the virtual keyboard. Enter the default admin password, 1234.

Note: You must enter an admin password. To change the Admin password, check **New Admin password** and enter the new password and confirm it.

Caution: It is strongly recommended that you change the password of the administrator. Do not leave 1234 as the default password. Write it down in a safe place so that you do not forget it.

If you should forget the password to your DVR, contact your supplier with the serial number of your DVR to obtain a secure code to reset your DVR.

Click **Next**.

6. Time and date configuration:

Select the desired time zone, date format, system time and system date.

Note: Daylight savings time (DST) cannot be configured from the wizard. See "Configuring time and date" on page 42 for more information on DST.

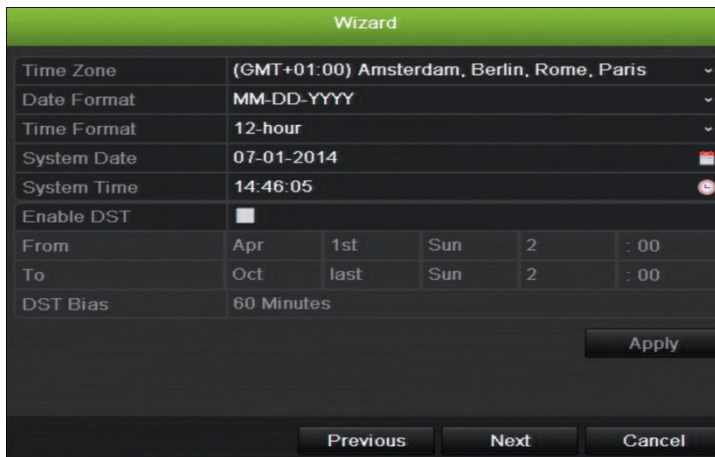

Note: The system time and date are visible on screen. However, they do not appear in recordings.

Click **Next** to move to the next page, or **Previous** to return to the previous page.

7. Network configuration:

Configure your network settings such as the NIC type, IP address, subnet mask and default gateway. Enter the preferred DNS server address as well as the alternate one to use.

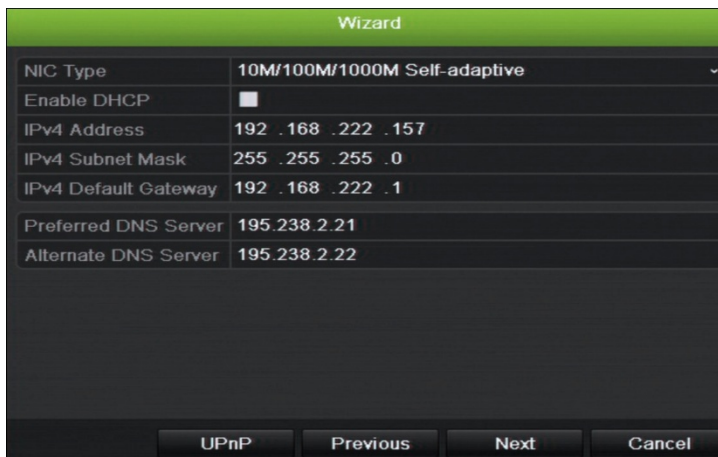

Click **Next** to move to the next page, or **Previous** to return to the previous page.

8. HDD management:

Configure your HDD settings as required.

You can group HDDs and assign cameras to a group. See “Setting up HDD groups” on page 122 for further information. You can also set up a drive for redundant recording. See “HDD redundancy” on page 98.

After configuring your HDD settings, click **Initialize** to initialize the HDD and **Next** to move to the next page, or **Previous** to return to the previous page.

9. Recording configuration:

Configure your recording settings as required. The settings apply to all cameras connected to the DVR. There are two recording configurations:

Auto record settings: The window for “Auto Record Settings” is shown below.

Duration Time(days)	30
Weekday	Y
Weekend	Y
Resolution	704*288(2CIF)
Total Capacity	1,863.02GB
Free Space	0MB
Use Free Space Only	<input type="checkbox"/>

Calculate

Frame Rate

Bitrate(Kbps)

Note: If you change them later, they will no longer be effective.

Previous Next Cancel

Advanced record settings: The window for “Advanced Record Settings” is shown below.

Global recording:

Constant recording

<input type="radio"/> TL-Hi	704*288(2CIF)	4fps
<input checked="" type="radio"/> TL-Lo	704*288(2CIF)	1fps
<input type="checkbox"/> Event(Motion)	704*288(2CIF)	6fps
<input type="checkbox"/> Alarm	960*576(960H)	25fps

Camera name

Previous Next Cancel

Check the **Constant Recording** checkbox for the DVR to record continuously all day. If left unchecked, the DVR will not record.

Check the **TL-Hi** check box and select its image resolution and frame rate.

Check the **TL-Lo** check box and select its image resolution and frame rate.

To record motion detection events, check **Event (Motion)** and select the image resolution and frame rate.

To record alarm events, check **Alarm** and select the image resolution and frame rate.

Under **Camera name** enter the camera name. A soft keyboard will appear to enter the characters.

10. When all the required changes have been entered, a page appears showing all the settings.

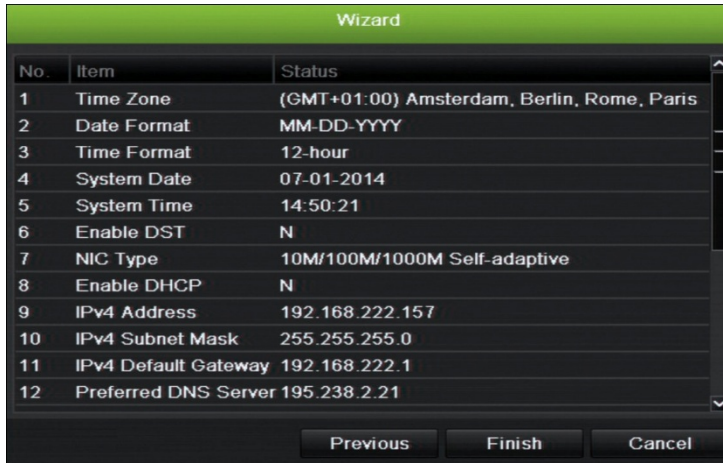

Click **Finish** to exit the Wizard. The TVR 42 is now ready to use.

Chapter 4

Operating instructions

Controlling the TVR 42

There are several ways to control the DVR:

- Front panel control
- Mouse control
- IR remote control
- KTD-405 keypad control (see Appendix)
- Web browser control

You can use your preferred control method for any procedure, but in most cases we describe procedures using mouse terminology. Optional control methods are given only when they differ substantially from mouse control methods.

Using the front panel

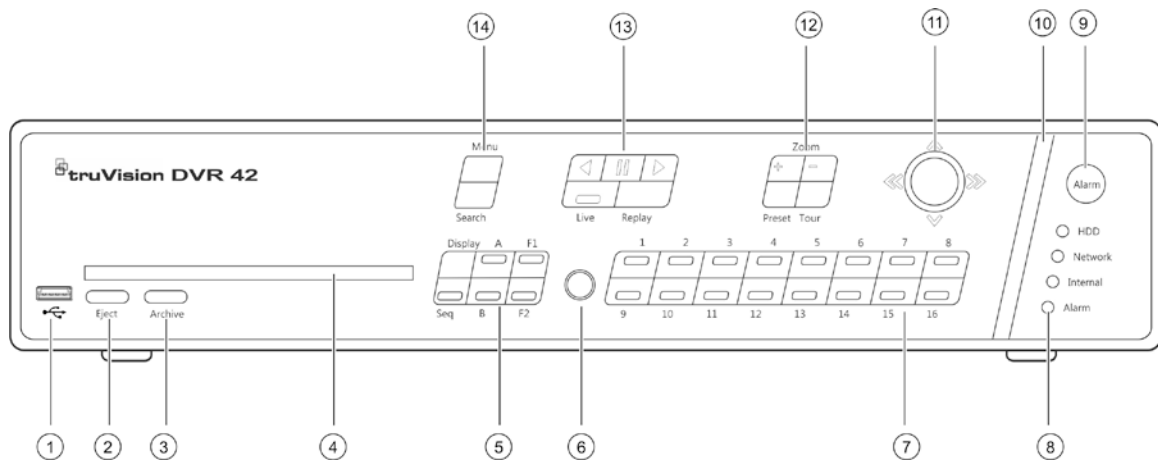

The function buttons on the front panel control can be used to operate many, but not all, of the main functions of the DVR. The LED indicators light up to alert you of various conditions. The functions available can be limited by setting passwords. See Figure 8 on page 25 for more information.

Figure 8: Front panel



The controls on the front panel include:

Item	Name	Description
1.	USB port	The recorder supports additional devices such as a USB mouse, CD/DVD burner, and a USB HDD on the front and rear USB ports.
2.	Eject button	Ejects CD/DVD disc.
3.	Archive button	Press once to enter quick archive mode. Press twice to start archiving.
4.	CD/DVD slot	Insert a CD or DVD disc.
5.	Display buttons	Display: Toggles through the various multiviews: full, quad, 1+5, 1+7, 9, and 16. Sequence: Starts/stops sequencing in live view mode. A: Selects the main monitor. B: Selects the spot monitor (in live view). F1: In all-day playback, click to start and stop video clipping. F2: In live view mode, click to display/hide the time bar. In all-day playback, click to hide/display the playback control toolbar.
6.	IR receiver	Receiver for IR remote.
7.	Channel buttons	Switch between different cameras in live, PTZ control or playback modes. Use the soft keyboard to enter numerals 0 to 9.

Item	Name	Description
8.	Status LEDs	<p>HDD: A steady green light indicates that the recorder is accessing the HDD in read or write mode. A steady red indicates a HDD failure.</p> <p>Network: A steady green light indicates that the recorder is currently connected to a network. No light indicates that it is not connected to a network.</p> <p>Internal: A steady green light indicates that the recorder is recording video or audio. No light means that it is not recording. A steady red light means that there has been an internal health failure.</p> <p>Alarm: A steady red light indicates that there is a sensor Alarm In or other alarm such as motion detection or tampering. A steady green light means there is no alarm.</p>
9.	Alarm button	Use to manually acknowledge an alarm. In live view mode, use it to call the alarm recipient.
10.	Alarm indicator bar	Blinking red indicates that there is an alarm.
11.	Joystick	<p>Use to select options in a menu and to control playback. Press for Enter. The LED arrows are lit when the jog is active.</p> <p>Live view mode: Press Enter to enter/exit PTZ mode.</p> <p>Menu mode: Move the joystick left/right and up/down to position cursor in the menu window. Press for Enter.</p> <p>Playback mode: Move the joystick left/right to slow down or speed up playback. Move it up/down to jump forwards or backwards by 30 seconds. Press Enter to stop/start playback.</p> <p>PTZ mode: Move the joystick to control the movement of the PTZ dome camera. Move the joystick left/right to slow down or speed up PTZ. Move it up/down to jump forwards or backwards by 30 seconds.</p>
12.	PTZ buttons	<p>Zoom: Use + and – for digital zoom.</p> <p>Preset: Call up preprogrammed preset positions.</p> <p>Tour: Call up preprogrammed shadow tours.</p>
13.	Playback buttons	<p> Reverse: In live view mode, press to jump back to the oldest available video and start play back. In playback mode, press to play back video in reverse. In snapshot playback mode, view snapshots in the reverse direction.</p> <p> Pause: In live view mode, freeze the last image of the live video. In playback mode, pause playback.</p> <p> Forward: In live view mode, press to start all-day playback of the currently selected camera. If you are in multiview format, only the camera shown in the top-left corner of the multiview is played back</p> <p>Live: Switch to live view mode.</p> <p>Replay: Replay the current file in playback Starts at the beginning of the file.</p>

Item	Name	Description
14.	Menu and Search buttons	Menu: Enter/exit the main menu. Search: In live view mode, enter the advanced search menu.

Using the mouse

The USB mouse provided with the DVR can be used to operate all the functions of the DVR, unlike the front panel which has limited functionality. The USB mouse lets you navigate and make changes to settings in the user interface.

Connect the mouse to the DVR by plugging the mouse USB connector into the USB port on the back or front panel. The mouse is immediately operational and the pointer should appear.

Note: Use a USB 1.1 or higher mouse.

Move the pointer to a command, option, or button on a window. Click the left mouse button to enter or confirm a selection.

You can purchase a spare mouse by ordering part number TVR-MOUSE-1.

See Table 4 below for a description of the mouse buttons.

Table 3: Mouse buttons

Item	Description	
Left button	Single-click	Live view: Select a camera to display the quick access toolbar (see “Accessing frequently used commands” on page 37). Menu: Select a component of a menu, such as a button or an input field. This is similar to pressing the Enter button on the remote/front panel controls.
	Double-click	Live view: Switch between single screen and multi-screen mode in live/ playback mode.
	Click and drag	Live view: Drag channel/time bar. PTZ control: Adjust pan, tilt and zoom. Tamperproof, privacy masking and motion detection functions: Select the target area. Digital zoom-in: Drag and select target area.
Right button	Single-click	Live view: Display menu. Menu: Exit the current menu and return to higher level.
Scroll-wheel	Scroll up	Live view: Return to the previous window. Menu: Move the selection to the previous item.
	Scroll down	Live view: Move to the next window. Menu: Move the selection to the next item.

Using the IR remote control

The TVR 42 is supplied with an infra red (IR) remote control unit. Like the mouse, it can be used to operate all of the main functions of the TVR 42.

The IR remote control can be programmed with a unique device ID address so that the controller will only be able to communicate with DVRs with that address. No programming is necessary if using a single TVR 42.

The device ID address only applies when using a remote control and not when using a keypad.

You can purchase a remote control by ordering part number TVR-REMOTE-1.

Figure 9: IR remote control

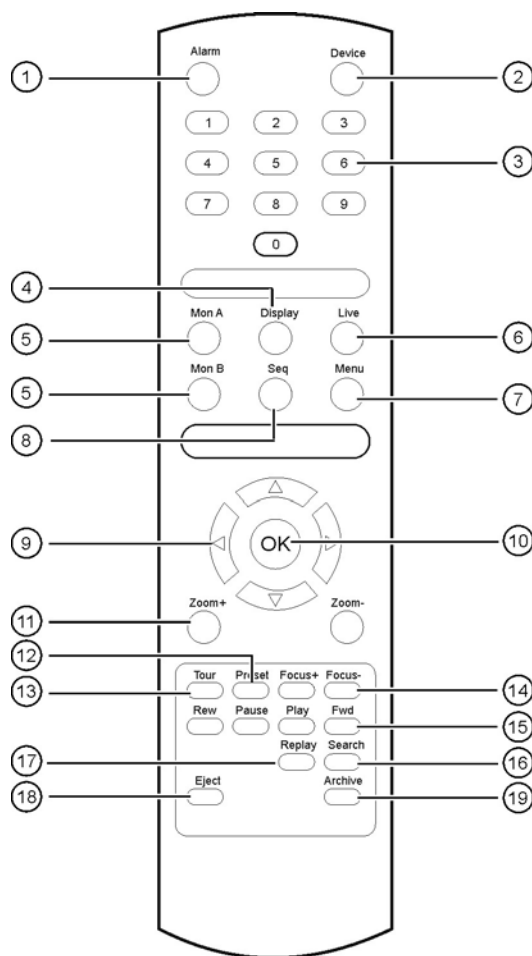

Item	Description
1. Alarm	Acknowledge an alarm.
2. Device	Enable/disable the IR remote control to control the TVR 42.
3. Numeric buttons	Select a camera, and enter a number in a menu option.
4. Display	Switch between the different multiviews.
5. Mon A and Mon B	Switch between monitors A and B.
6. Live	Return to live view mode.

Item	Description
7. Menu	Activate the main menu.
8. Seq	Start /stop sequencing.
9. < , > , ^ , v	In Menu mode: Use left or right arrow buttons to select and up or down arrow buttons to edit entry. In PTZ mode: Use to control PTZ. In Playback mode: Use to control playback speed.
10. OK	Confirm selection.
11. Zoom + and -	Use to control zoom of camera lens.
12. Preset	Enter preprogrammed three-digit code to call up a preset.
13. Tour	Enter preprogrammed three-digit code to call up shadow tour.
14. Focus + and -	Use to control focus of camera lens.
15. Playback control	Use to control playback (Rewind, Pause, Play, and Fast Forward).
16. Search	Open the Search menu.
17. Replay	Replay the selected file from the beginning.
18. Eject	Eject the CD or DVD disk.
19. Archive	Press once to enter quick archive mode. Press twice to start archiving.

Aim the remote control at the IR receiver located at the front of the unit to test operation.

To connect the remote control to the TVR 42:

1. Press the **Menu** button on the front panel or right-click the mouse and select the **Menu** button. The main menu window appears.
2. Click **Display Mode Settings > Monitor**.
3. Check the device address value. The default value is 255. This device address is valid for all IR controls.
4. On the remote control press the **Device** button.
5. Enter the device address value. It must be the same as that on the TVR 42.
6. Press **OK** on the remote control.

To place batteries into the IR remote control:

1. Remove the battery cover.
2. Insert the batteries. Make sure that the positive (+) and negative (-) poles are correctly placed.
3. Replace the battery cover.

Troubleshooting the remote control:

If the IR remote control is not functioning properly, perform the following tests:

- Check the battery polarity.
- Check the remaining charge in the batteries.
- Check that the IR remote control sensor is not masked.

If the problem still exists, please contact your administrator.

Menu overview

The TVR 42 has an icon-driven menu structure that allows you to configure the unit's parameters. Each command icon displays a dialog window that lets you edit a group of settings. Most menus are available only to system administrators.

The configuration window is divided into three sections. The currently selected command icon and submenu item are highlighted in green. See Figure 10 below.

You must be in live view to access the main menu.



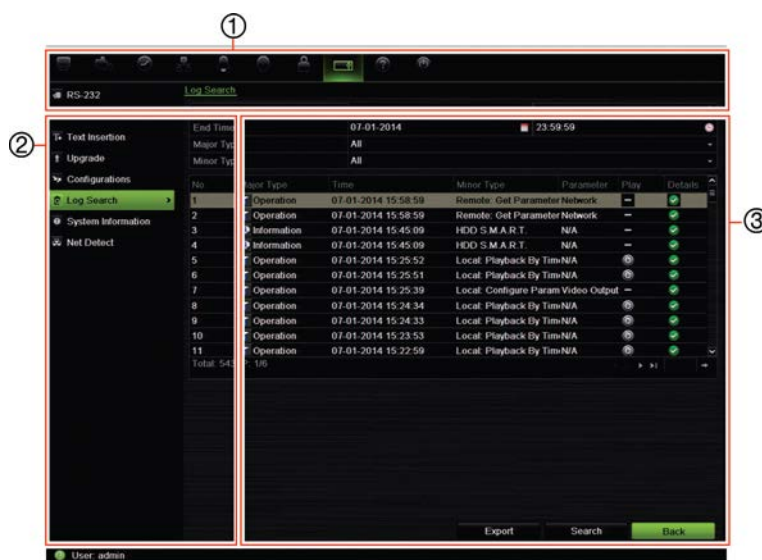

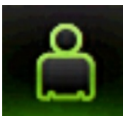



Figure 10: Menu structure



1. **Menu toolbar:** Setup options available for the selected configuration menu function. Move the mouse over a command icon and click to select it. See Table 5 below for a description of the icons.
2. **Submenu panel:** Submenus for the selected menu function are displayed. Click an item to select it.
3. **Setup menu:** All the details for the selected submenu are displayed. Click a field to make changes.

Table 4: Description of the menu toolbar icons

Icon	Name	Description
	Display mode settings	Configures display settings including dwell time, schedule, language, system date and time, audio output, device name, and display formats. See "Configuring live view" on page 39 and "Holiday schedules" on page 95.

Icon	Name	Description
	Camera management	Configures camera settings including OSD display, motion detection, video image adjustments, camera title, privacy mask, tamper-proof, video loss, coverts camera, and copy settings to other cameras. See Chapter 14 "Camera settings" on page 128.
	Video schedule	Configures recording settings including recording schedules, record quality, auto delete mode, manual record, overwrite, v-stream encoding, auto archive, and recording mode. See Chapter 10 "Recording" on page 89.
	Network settings	Configures standard network settings including IP address, e-mail notifications, DDNS setup, and advanced network settings. See Chapter 12 "Network settings" on page 111.
	Alarm settings	Configures alarm settings including alarm input, relay output, video loss, remote alert, pre-alarm and post-alarm seconds, and buzzer time. See Chapter 11 "Alarm settings" on page 100.
	PTZ settings	Configures PTZ settings. See Chapter 6 "Controlling a PTZ camera" on page 47.
	User management	Configures users, passwords, and access privileges. See Chapter 16 "User management" on page 139.
	System settings	Configures system settings including system date and time, audio output, device name, RS-485 settings, RS-232 settings, firmware upgrade, hard drive settings, boot log, default settings, import/export configuration file, and shutdown. See Chapter 13 "HDD management" on page 121 and Chapter 15 "DVR management" on page 132.
	Help information	Provides reference information to the various toolbars, menus, and keys within the interface.
	Power manager	Provides access to logout, reboot and shutdown options. See "Turning on and off the DVR" on page 19.

To access the main menu:

- In live view, press the **Menu** button on the remote control or front panel.
- Or -
Right-click the mouse and select **Menu** from the pop-up menu.
The main menu window appears. The Display window appears by default.
- Click the required menu icon to display its submenu options. Modify the configuration parameters as required.
- Click **Apply** to save the settings.

4. Click **Back** to return to live view.



Using the soft keyboard

A keyboard will appear on-screen when you need to enter characters in a window option. Click a key to input that character.

Figure 11: The soft keyboard

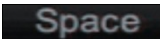
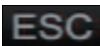

Description of the keys in the soft keyboard:

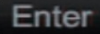
	Switch to lowercase/uppercase
	Space
	Exit the soft keyboard
	Alphanumeric characters
	Backspace
	Confirm selection

Exiting the main menu

Press the **Menu** button on the front panel to exit the current menu window and return to live view or click **Back** in a main menu.

Chapter 5

Live view







Description of live view

Live view is the normal operating mode of the unit where you watch live images from the cameras. The TVR 42 automatically enters into live view once powered up. On the monitor, you can see the current date and time, camera name, and whether a recording is in progress.

Status information

Information on the system and camera status is displayed as icons on the main and spot monitors. The camera status icons are shown for each camera. Each icon represents information on a specific item. These icons include:

Table 5: Description of the on-screen status icons

Icon	Description
	Indicates a sensor alarm.
	Indicates recording (such as recording, motion detection or alarm-triggered recording).
	Indicates a motion detection event.
 No Video Link	Indicates a video loss event.
	Indicates alarm and system notifications. Clicking the icon opens a window that lists the alarms and notifications.
	Indicates manual recording.

More than one icon can be displayed at the same time.

The system status is displayed on the front panel by the status LEDs.

Video output

The recorder automatically checks the monitor outputs used. If more than one monitor is connected, it then defines which monitor is the main one and which is the event one. The spot monitor is used to display detected events such as motion. Only one monitor can be controlled at a time.

If a HDMI monitor is used, it will be the main output. If HDMI and VGA monitors are both connected to the DVR, both will be main monitors; they will both show the same view. However, you will not be able to control each individually.

To select the video output of the main monitor:

1. From the menu toolbar, click **Display Mode Settings > Layout > General**.
2. From **Video Output Interface**, select which monitor will be the main monitor: HDMI (depends on DVR model), VGA, main analog, or spot output. VGA is default, if connected.

To control a monitor:

On the front panel, press button A to select the main monitor. Press button B to select the spot monitor.

Audio output

The HDMI monitor connector on the back panel outputs both video and audio signals. There are audio outputs on the back panel for speakers.

Controlling live view

Many features of the live view can be quickly accessed by placing the cursor on a live image and clicking the right-button of the mouse. The mouse menu appears (see Figure 12 on page 35).

Figure 12: The mouse menu for the main monitor

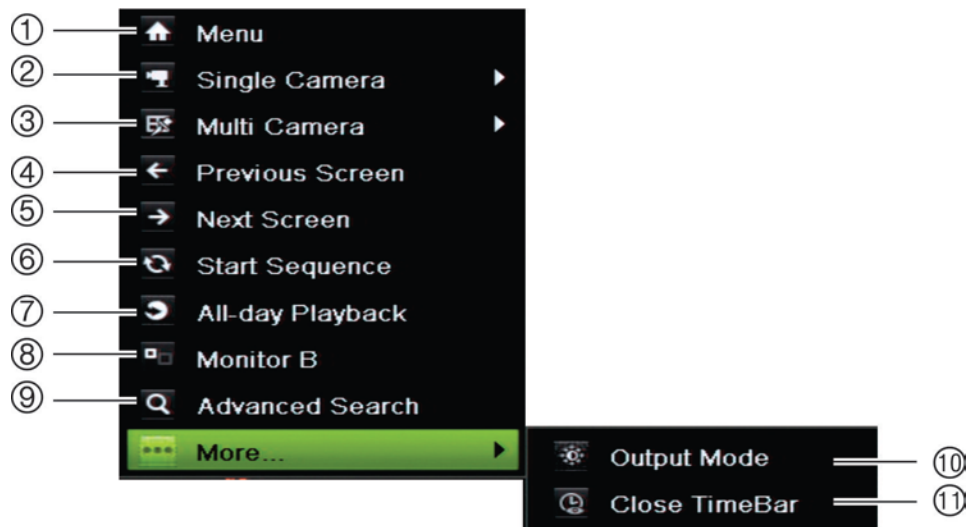

The list of commands available depends on which monitor is active; main or spot (monitor B). See Table 7 below. The default settings of these commands are provided in Appendix G “Default menu settings” on page 160.

Table 6: Mouse menu for monitor A (main monitor)

Item	Name	Description
1.	Menu	Enter the Main menu. This option is not available from monitor B.
2.	Single Camera	Switch to a full-screen view for the selected camera from the dropdown list.
3.	Multi Camera	Switch between the different multiview options from the dropdown list.
4.	Previous Screen	In single-camera mode, display the previous camera. In multi-camera mode, display the previous screen cameras.
5.	Next Screen	In single-camera mode, display the next camera. In multi-camera mode, display the next screen cameras.
6.	Start Sequence	Turn on sequence mode. The window automatically sequences between cameras. See “Viewing in multiview” on page 36. Go to Menu > Display Mode Settings > Layout > General > Dwell Time to set up.
7.	All-day Playback	Playback the recorded video of the selected day from the selected camera. The current day is selected by default. See “Previous-day playback” on page 58 for more information.
8.	Monitor B	Switch between monitors A (main) and B (spot).
9.	Advanced Search	Enter the advanced video search menu. See “Searching recorded video” on page 59 for more information.
10.	Output Mode	Select desired output mode: Standard, bright, soft, and vivid.
11.	Close TimeBar	Open/close the time bar.

Note: When the monitor B is active, the main monitor commands are unavailable.

Table 7: Mouse menu for monitor B (spot monitor)

Item	Name	Description
1.	Single camera	Switch to a full-screen view for the selected camera from the dropdown list.
2.	Multi camera	Switch between the different multiview options from the dropdown list.
3.	Previous screen	In single-camera mode, display the previous camera. In multi-camera mode, display the previous screen cameras.
4.	Next screen	In single-camera mode, display the next camera. In multi-camera mode, display the next screen cameras.
5.	All-day playback	Playback the recorded video of the selected day from selected cameras. See "Previous-day playback" on page 58 for more information.
6.	Monitor A	Switch between monitors A (main) and B (spot).

Multiview format

The DVR has full screen display format as well as five multiview formats.

Viewing in full screen

Press the numeric button on the front panel to switch to the corresponding camera display. For example, press button 10 to view camera 10.

Right-click the mouse and select **Single Camera** from the menu. Select the camera required from the list.

Viewing in multiview

A video tile is any cell in a multiview display. A camera image can only be shown in one video tile at a time. The TVR 42 has five multiview display formats available as well as full screen. See Figure 13 below.

To change the multiview display that appears by default, go to the Display menu. See "Changing the camera sequence" on page 41 for more information.

Figure 13: Multiview display formats

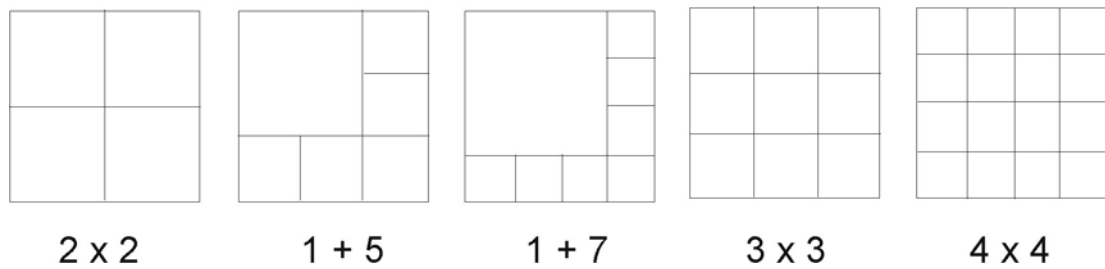

To select a multiview format:

1. Press the Display button on the front panel to cycle through different display formats.
You can also right-click the mouse and select **Multi Camera** from the menu. Select the desired multiview display layout.

Sequencing cameras

The sequencing feature allows a camera to be displayed briefly on screen, before advancing to the next camera in the sequence list. Sequencing can only be done in full screen mode.

The default sequence displays each camera in numerical order. However, each camera on the main and spot monitors can have a pre-programmed-sequence order. See “Changing the camera sequence” on page 41 for more information.

Note: Dwell time must not be set to zero for sequencing to function.

Sequencing live view mode using the front panel:

1. Select the camera where you want to start sequencing.
2. Press the **Seq** button on the front panel to start sequencing.
3. Press the **Seq** button again to stop the sequencing.

Sequencing live view mode using the mouse:

1. Select the camera where you want to start sequencing.
2. Right-click the mouse and select **Start Sequence** to start the sequencing.
3. Right-click the mouse and select **Stop Sequence** to stop the sequencing.

Accessing frequently used commands

The quick access toolbar in live view lets you quickly access regularly used commands. Position the cursor over a video image and left-click the mouse. The toolbar appears (see Figure 14 below).

Figure 14: Quick access toolbar



Table 8: Description of the quick access toolbar icons

Icon	Description
	Freeze: Freeze the live image of the selected camera. Although the image pauses, time and date information does not. The system clock continues to run.
	Manual record: Start/stop manual recording. The icon is red when manual recording is enabled. See “Manual recording” on page 95 for information on setting up this function.
	Instant playback: Play back the recorded video from the last five minutes (default time). If no recording is found, then there was no recording made. Click the icon and select the desired camera. Click OK. See “Instant playback” on page 57 for information on changing this time.
	Audio: Enable/Disable audio output. The audio option must already have been setup in the Display menu.
	Quick snapshot: Capture a snapshot of a video image. The image is saved on the unit.
	PTZ control: Enter PTZ control mode.
	Digital zoom: Enter digital zoom. See “Digital zoom” below for further information.
	Image settings: Enter the image settings menu to modify the image lighting levels. There are three options: Preset Mode: These are preconfigured image lighting levels. Select one of the four options depending on current lighting conditions: <ul style="list-style-type: none"> - <i>Standard:</i> Use in standard lighting situations. - <i>Indoor:</i> Use indoors. - <i>Dim Light:</i> Use when the light level is low. - <i>Outdoor:</i> Use when outdoors. The contrast and saturation values are high. Customize: Modify brightness, contrast, saturation, and hue values. Restore: Restore image settings to previous values. These settings can also be modified from the Camera>Image menu (see page “Adjusting camera image settings” on page 130.
	Text show: Display inserted text on screen. Color of the text can be changed: Black, white, or pink.
	Close toolbar: Close the shortcut toolbar.

Digital zoom

You can easily zoom in or out of a camera image in live view and playback using the digital zoom command. The zoom command magnifies the camera image four times. See Figure 15 below.

Figure 15: Digital zoom window



To quickly zoom in/out on a camera image:

1. Left-click the mouse on the desired camera. The quick access toolbar appears.
2. Left-click the mouse and select the digital zoom icon, or on the front panel press the **Zoom+** button. The digital view window appears.
3. Left-click the mouse and drag the red square to the area of interest, or move the joystick on the front panel to position the red square. The selected area is magnified.
4. To exit digital zoom, right-click the mouse or press the **Zoom—** button on the front panel.

Configuring live view

The setup of live view can be modified from the main menu to suit different needs, such as the different monitors, multiview layout, and dwell time options. You can also enable audio output.

In the Layout menu use the Video Output Interface, Live View Mode, Dwell Time, and Enable Audio Output settings to configure the main monitor. Use Event Output as well as Event and Alarm Full Screen Monitoring Dwell Time settings to configure the spot monitor.

Figure 16: Layout window

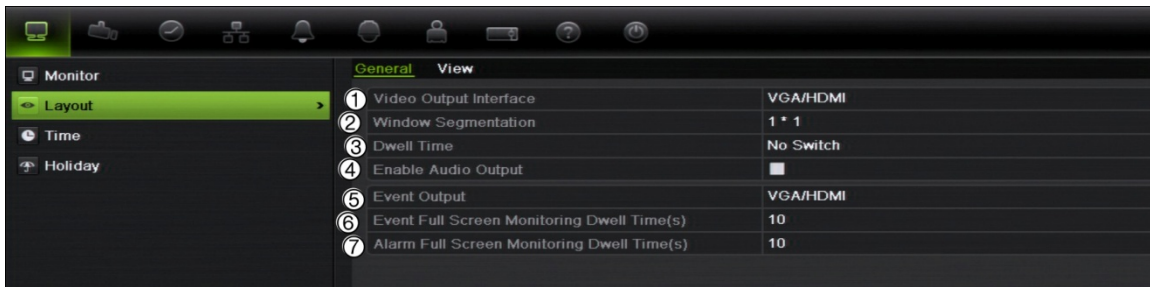

Table 9: Description of the layout window

Submenu name	Description
General tab	
1. Video output interface	Select which monitor will be the main monitor: HDMI (depends on DVR model), VGA, main analog or spot output. Default is VGA, if connected.
2. Live view mode	Select which multiview layout will be default in live view mode. Default is 4x4 multiview layout.
3. Dwell time	Set the length of time for which a camera image is displayed on the selected monitor before moving to the next camera during sequencing. Default is off ("No switch").
4. Enable audio output	You can hear audio from cameras in both live and playback mode. However, in order to be able to hear audio in playback you must enable the audio output setting. Check the box to enable/disable audio output.
5. Event output	Select which monitor will be the spot monitor. Default is the spot monitor (Spot output 1).
6. Event full screen monitoring dwell time	Set the length of time for which an event appears on the selected monitor before moving to the next camera during sequencing. Default is 10 seconds.
7. Alarm full screen monitoring dwell time	Set the length of time for which a camera that has an alarm event appears on the selected monitor before moving to the next camera during sequencing. Default is 10 seconds.

To set up the display options:

1. Click the **Display Mode Settings** icon in the menu toolbar.
2. Select **Layout > General**.
3. Specify the desired settings for each of the menu options.
4. Click **Apply** to save the settings.
5. Click **Back** to return to live view.

Changing the camera sequence

The cameras are sequenced in numeric order by default. You can change the sequence order of the cameras for VGA/HDMI, analog, and spot monitors.

You can switch the channel of a camera with that of another camera in the system. This lets you, for example, have the images of camera 1 appear on channel 10, and the images of camera 10 appear on channel 1. This feature is useful when you want to watch the sequence of images from specific cameras so that they are next to each other on-screen.

See Figure 17 below. Each video tile displays both the order of the camera in the sequence and the camera number.

Figure 17: Camera layout and sequence window

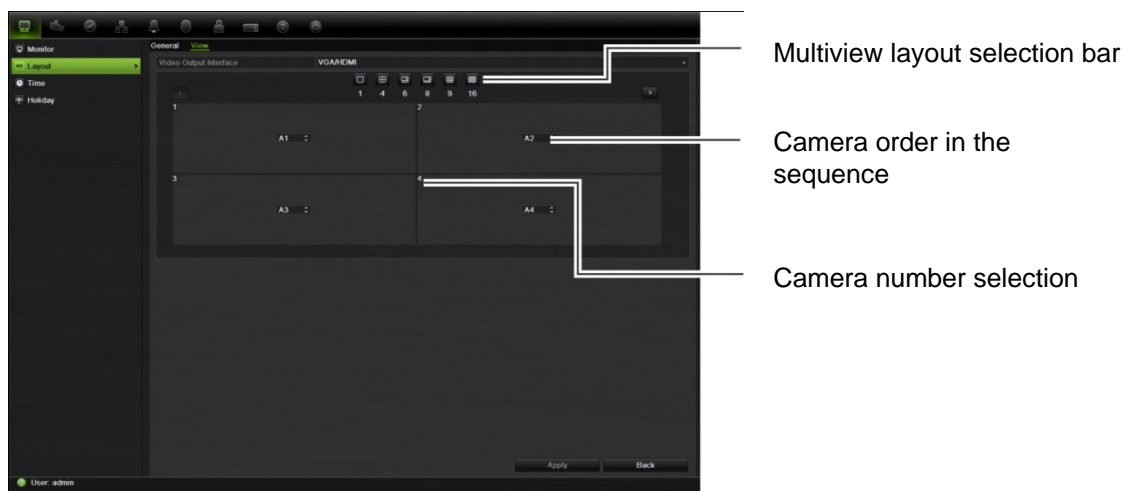

To set the camera sequencing:

1. Click the **Display Mode Settings** icon in the menu toolbar.
2. Select **Layout > View**.
3. From **Video Output Interface**, select the desired monitor from the drop-down list.
4. From the multiview layout selection bar, select the desired multiview layout.
5. Select the video tile of the camera whose order you want to change. The selected tile is highlighted green.
6. In the selected tile, select the new camera sequence order by scrolling the through the list of available camera numbers.

Note: "X" means that the camera is not displayed.

7. Click **Apply** to save the settings.
8. Click **Back** to return to live view.

Camera sequencing for alarms and events

You can select which monitor is used to sequence alarm and event cameras in full screen mode. Normally this is the spot monitor. When an alarm or event occurs, the selected monitor will sequence through the alarm/event cameras depending on the dwell time set up. You can set up different dwell time for alarms and events.

To set the camera sequencing for alarms and events:

1. Click the **Display Mode Settings** icon in the menu toolbar.
2. Select **Layout > General**.
3. From **Event Output**, select the desired monitor from the drop-down list. Default is VGA, if connected
4. Select the dwell times for the alarm and event cameras. Default is 10 seconds. The dwell time can range between 10 and 300 seconds.
5. Click **Apply**.

Configuring time and date

You can set up the date and time that will appear on-screen. It is not included in recordings. This time and date display is separate from the embedded one that appears for each camera (see “Configuring the camera OSD settings” on page 128 for more information on embedded camera time and date).

The start and end time of daylight savings time (DST) in the year can also be set. DST is deactivated by default. See Figure 18 below for the Time settings window.

Figure 18: Time and date settings window



Table 10: Description of the time and date settings window

Option	Description
1. Time Zone	Select the time zone of the DVR from the drop-down list.
2. Date Format	Select the date format from the drop-down list. Default format is DD-MM-YYYY.
3. Time Format	Select the time format from the drop-down list. Default format is 24-hour format.
4. Display Week	Display the day of the week in the monitor time bar. Check the box to enable/disable. Default format is Disable.
5. System Date	Define the system date. Default date is the current date.
6. System Time	Define the system time. Default time is the current time.
7. Auto DST Adjustment	Define DST is automatically. It depends on the time zone selected. Default format is Disable
8. Enable DST	Manually define DST. If this option is selected, the Auto DST adjustment option is disabled. Default format is Disable. Click the check box to enable or disable daylight savings time (DST).
9. From	Enter the start date and time for daylight savings.
10. To	Enter the end date and time for daylight savings.
11. DST bias	Set the amount of time to move DST forward from the standard time. Default is 60 minutes.

To set up the system time and date:

1. Click the **Display Mode Settings** icon in the menu toolbar.
2. Select **Time**. Modify the required settings.
3. Click the **Apply** button to immediately implement the changes.

General settings

Use the Display settings menu to configure general DVR options on how information is displayed and accessed such as:

- Change GUI language
- Change the DVR name and address
- Define the monitor resolution
- Enable/disable the login password requirement
- Enable/disable the wizard

- Manually change the video output format (PAL/NTSC)
- Change the time out period after which the display reverts to showing live view
- Enable/disable the transparency of the menus on screen
- Enable/disable whether the status icons appear on screen

See Figure 19 below and Figure 20 on page 45.

The changes are immediately implemented once Apply is clicked to save the settings.

Figure 19: Monitor setup window: General Settings

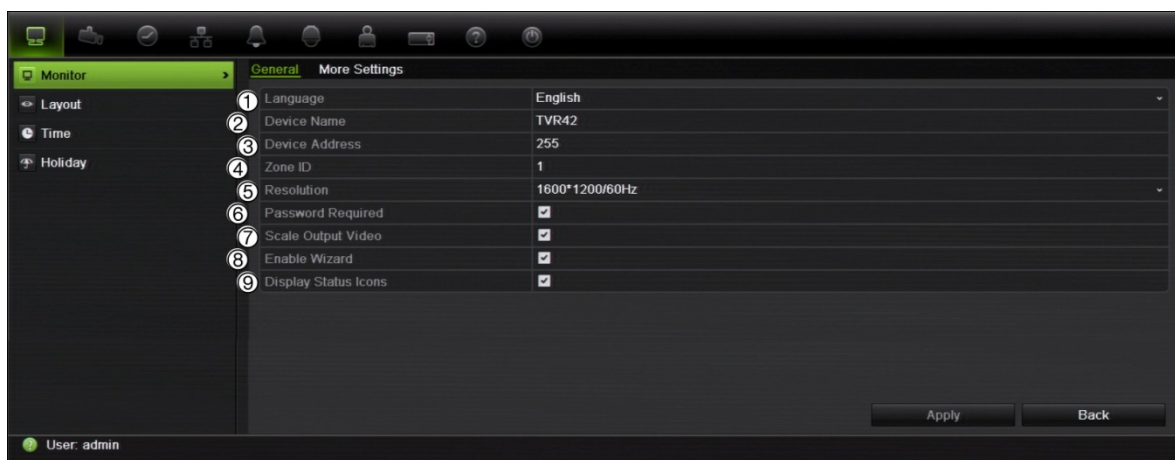

Table 11: Description of the Monitor setup window: General Settings

Option	Description
1. Language	Change the language of the system. Select the desired language from the drop-down list and click Apply . The language displayed changes immediately.
2. Device Name	Define the DVR name. The default name is TVR 42. Click the edit box and enter the new name from the soft keyboard.
3. Device Address	The device number to use for the DVR when programming the remote control. The default value is 255.
4. Zone ID	Each DVR in a daisy chain must have a unique zone ID so that it can be controlled by a KTD-405 keypad. The default value is 1.
5. VGA Resolution	Define the VGA resolution. Select one of the options from the drop-down list and click Apply . The selected resolution must be the same as that of the monitor.
6. HDMI Resolution	Define the HDMI resolution. Select one of the options from the drop-down list and click Apply . The selected resolution must be the same as that of the monitor.
7. Password Required	Define whether a login password is required. Check the box to enable/disable and click Apply .

Option	Description
8. Scaling output video	Enable/disable the monitor display of the main and spot monitor size to accommodate for differently sized monitors. Check the box to enable/disable and click Apply .
9. Enable wizard	Define whether the wizard tool starts when the DVR is turned on. Check the box to enable/disable and click Apply .

Figure 20: Monitor setup window: More Settings



Table 12: Description of the Monitor setup window: More Settings

Option	Description
Monitor Standard	The video standard used is auto detected but can be manually changed. Modify the video standard used to PAL or NTSC and click Apply .
Output Mode	Define the desired output mode. Select one of the options from the drop-down list: Standard, Bright, Gentle, or Vivid.
Monitor Brightness	Modify the video output brightness. Adjust the scroll bar point to the desired level and click Apply .
Event Hint	Define whether the status icons appear on screen. See “Status information” on page 33 for more information.
Timebar Transparent	Modify the transparency of the menus on-screen relative to the background to make the menu windows easier to read or less prominent on-screen. Default is non-transparent. Select one of the options from the drop-down list.
Menu Timeout	Define the time in minutes after which the menu window reverts to live view mode. Select a time from the drop-down list and click Apply .
Mouse Pointer Speed	Modify the speed of the mouse pointer. Adjust the scroll bar point to the desired level and click Apply .

Option	Description
Other Notification: Panel Alarm LED	Check to enable the Motion alarm option.
Motion Alarm	Define whether the status LEDs on the front panel start flashing when motion is detected. Check the box to enable/disable and click Apply .
Instant Playback Time	Modify the instant playback replay period. The time options are between 5 and 30 minutes from the actual time. Default is five minutes.
Enable Logout Lock	When the system is logged out, the front panel is automatically locked immediately. To unlock the front panel, press the Live button for 5 seconds.
Disable Network Disconnect Alarm	Define whether there is an alarm notification if the network connection is disconnected. Default is an alarm notification. The alarm on-screen status icon appears. Check the box to disable the alarm notification.

V-stream encoding

If the available bandwidth is limited you can remotely view several channels in real time with one stream over the web browser or CMS (Client Management System), such as TruVision navigator, using the V-stream encoding option (“V” stands for “virtual”). When enabled, you can see the output from the cameras on an analog spot monitor in one stream.

Note: It is not recommended to use the V-stream feature when using an analog monitor as main monitor as both the analog main monitor and the V-stream use the same output.

To enable v-streaming:

1. Click the **Video Schedule** icon in the menu toolbar.
2. Select **Encoding > V-stream Encoding**.
3. Check **Enable V-stream Encoding**.
4. Select the desired settings for frame rate, and maximum bit rate (Kbps).
5. Click **Apply** to save the settings.

Chapter 6

Controlling a PTZ camera

You can control PTZ dome cameras using the buttons on the front panel, the keypad, and IR remote control as well as using the PTZ control panel accessed with the mouse. Access to PTZ commands may require a password.

A detailed list of the PTZ commands available for many different camera protocols is available in Appendix F on page 158.

Configuring PTZ settings

Use the **PTZ Settings** menu to configure the PTZ dome cameras. Each camera must be set up individually. Cameras must be configured before they can be used.

Ensure that the PTZ dome cameras are correctly connected to the RS-485 port on the back panel.

Note: If a camera does not work correctly after configuring the DVR, check the parameters entered.

To configure PTZ dome camera settings:

1. Click the **PTZ Settings** icon in the menu toolbar.
2. Click **General** and select the PTZ dome camera to be configured from the drop-down camera list.
3. Select the baud rate, data bit, stop bit, parity, flow control, PTZ protocol and address for the camera.

Note: It is important to ensure that the settings correspond with those used in the PTZ camera.

4. Click **Copy** to copy the settings to another camera, if required, and select the cameras.
5. Click **Apply** to save the settings.

Calling up presets, preset tours and shadow tours

When in live view you can quickly call up the list of existing presets, preset tours and shadow tours by using the front panel, remote control, mouse and keypad.

Front panel	Press the joystick to Enter. PTZ control panel appears.
Mouse	Right-click the mouse on the desired camera image. The quick access toolbar appears. Click the PTZ control icon to enter PTZ mode. The PTZ control panel appears.
Remote control	Press the OK button. The PTZ control panel appears.
Keypad	Press the Enter ↵ button on the keypad. For further information, see Appendix D “KTD-405 keypad” on page 148.

If the display was in multiview format, it changes to full screen format for the selected camera. See Figure 21 below for a description of the PTZ control panel.

Figure 21: PTZ control panel

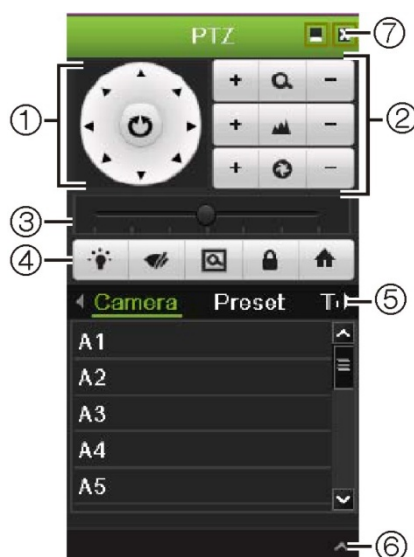







Table 13: Description of the PTZ control panel

Name	Description
1. Directional pad/auto-scan buttons	Controls the movement and direction of the PTZ camera. Center button is used to start auto-pan by the PTZ dome camera.
2. Zoom, focus and iris	Adjusts zoom, focus and iris.
3. PTZ movement	Adjusts the speed of PTZ movement.
4. Toolbar	 Turns on/off camera light.
	 Turns on/off camera wiper.
	 Zoom area.
	 Centers the PTZ dome camera image. This command is not supported on all PTZ dome cameras.

Name	Description
	 Jumps to the home position.
5. Select PTZ command	Displays the desired function from the scroll bar: camera, preset, preset tour or shadow tour.
6. Open/close menu	Opens/closes the PTZ command section of the PTZ control panel.
7. Exit	Exits the PTZ control panel.

Setting and calling up presets



Presets are previously defined locations of a PTZ dome camera. It allows you to quickly move the PTZ dome camera to a desired position. They are configured and modified from the PTZ configuration window (see Figure 22 below).







Note: The PTZ dome camera used must be able to support a preset command. See Appendix F on page 158 for the complete list of PTZ commands available by camera protocol.

Figure 22: PTZ configuration window



Table 14: Description of the PTZ configuration window

Name	Description
1. Save preset	Saves preset.
2. Call preset	Calls up pre-existing preset.
3. Shadow tour toolbar	 Starts recording the shadow tour.
	 Saves the shadow tour.
	 Starts the selected shadow tour.

Name	Description
	 Deletes the selected shadow tour.
4. Preset tour toolbar	 Adds a step to a selected preset tour.
	 Starts the selected preset tour.
	 Stops the selected preset tour.
	 Deletes all the preset tour steps.
	 Scroll up the list.
	 Scroll down the list.
5. PTZ control panel	See “Calling up presets, preset tours and shadow tours” on page 48 for more information.

To set up a preset:

1. From the menu toolbar, click **PTZ Settings > More Settings**.
2. Use the directional, zoom, focus and iris buttons to position the camera in the desired preset location.
3. Check **Save Preset** and enter a preset number. The preset is enabled and stored in the camera.

If the desired preset number is larger than the 17 numbers listed, click [...]. The Preset window appears. Select a preset number from the dropdown list and click the **OK** button to save changes.

Note: Presets can be overwritten.

4. Click **Back** to return to live view.

To call up a preset:

• **PTZ control panel:**

1. In live view left-click the mouse and select the PTZ control icon in the quick access toolbar. The PTZ control panel appears. Select the desired camera from the toolbar.

– Or –

On the front panel, select the desired camera and press **Enter** on the joystick to call up the quick access toolbar. The PTZ control panel appears.

2. Scroll the toolbar to **Preset** and double-click the desired preset from the list. The camera immediately jumps to the preset position.

• **Menu toolbar:**

1. From the menu toolbar, click **PTZ Settings > More Settings**.
2. Check **Call Preset** and enter the preset number to call up. The camera immediately moves to that preset position.
3. Click **Back** to return to live view.

Setting and calling up preset tours

Preset tours move a PTZ dome camera to different steps (called “Keypoint” in the interface). The camera stays at a step for a set dwell time before moving on to the next step. The steps are defined by presets (see “Setting and calling up presets” on page 49.)

Each preset tour consists of steps. A step consists of a step number, a dwell time, and a speed.

The step number is the order the camera will follow while cycling through the preset tour. The dwell time is the length of time for which a camera stays at a step before moving to the next one. The speed is the rate at which the camera will move from one key point to the next.

Note: The PTZ dome camera used must be able to support a preset tour command. See Appendix F on page 158 for the complete list of PTZ commands available by camera protocol.

To set up a preset tour:

1. From the menu toolbar, click **PTZ Settings > More Settings**.
2. Select the preset tour number.
3. In the preset tour toolbar, click  to add a step to the preset tour. The Keypoint window appears. Select the preset number, dwell time and speed of the step. Click **OK** to save the settings.



Note: A preset tour should have at least two presets.

4. Repeat step 3 to configure other steps (“Keypoints”) in the preset tour.



5. In the preset tour toolbar, click  to call up the preset tour.

6. Click **Back** to return to live view.

To delete a preset tour:

1. From the menu toolbar, click **PTZ Settings > More Settings**.
2. From the preset list, select a tour number and click  to delete the selected the preset tour.

– Or –

In the preset tour toolbar, click  to delete all the preset tours for the selected tour.

3. Click **Back** to return to live view.

To call up a preset tour:

- **PTZ control panel:**



1. In live view left-click the mouse and select the PTZ control icon in the quick access toolbar. The PTZ control panel appears. Select the desired camera from the toolbar.

– Or –

On the front panel, select the desired camera and press **Enter** on the joystick to call up the quick access toolbar. The PTZ control panel appears.

2. Scroll the toolbar to **Tour** and double-click the desired preset tour from the list. The camera immediately carries out the preset tour movement.

- **Menu toolbar:**

1. From the menu toolbar, click **PTZ Settings > More Settings**.
2. Select the desired preset tour from the list and click  to start the shadow tour. Click  to stop the preset tour.
3. Click **Back** to return to live view.



Setting and calling up a shadow tour

The shadow tour command remembers the manually-controlled PTZ dome camera movement track. One shadow tour can be set up.

Note: The PTZ dome camera used must be able to support a shadow tour command. See Appendix F on page 158 for the complete list of PTZ commands available by camera protocol.

To set up a shadow tour:

1. From the menu toolbar, click **PTZ Settings > More Settings**.
2. Select the shadow tour from the list.

3. To record a new shadow tour, click  and use the directional buttons on the PTZ control panel to move the camera along the desired path.
4. Click  to save the shadow tour.
Note: The shadow tour can be overwritten.
5. Click **Back** to return to live view.

To call up a shadow tour:

- **PTZ control panel:**



1. In live view left-click the mouse and select the PTZ Control icon in the quick access toolbar. The PTZ control panel appears. Select the desired camera from the toolbar.

– Or –

On the front panel, select the desired camera and press **Enter** on the joystick to call up the quick access toolbar. The PTZ control panel appears.

2. Scroll the toolbar to **Shadow Tour** and double-click the shadow tour from the list. The camera immediately carries out the shadow tour movement.

- **Menu toolbar:**

1. From the menu toolbar, click **PTZ Settings > More Settings**.
2. Select the shadow tour from the list and click  to start the shadow tour. Click  to stop the shadow tour.
3. Click **Back** to return to live view.

Chapter 7

Playing back a recording

The TVR 42 lets you to quickly locate and play back recorded video. There are four ways to play back video:

- Instant playback of the most recently recorded video
- All-day playback of the day's recorded video
- Search the video archives by specific time, date, bookmark, snapshot, or event
- Search the system log

The DVR continues to record the live view from a camera while simultaneously playing back video on that camera display. You must have the access privilege to play back recordings (see “Customizing a user’s access privileges” on page 140 for more information).

Cameras in multiview mode play back simultaneously. This means, for example, that it is easy to follow the path of an intruder who has passed in front of several cameras.

You must be in live view mode to play back video.

Overview of the playback window

It is easy to manage playback from the playback window.

The playback video can be set up to display a time/date stamp for evidentiary purposes (see “Configuring the camera OSD settings” on page 128).

Figure 23: Playback window



1. Playback viewer.
2. Camera panel. Select the cameras for playback. Move the mouse over the area to display the list of cameras available..
3. Calendar panel.
Blue: Current date
Yellow: Recordings available on the DVR
4. Playback control toolbar. See Figure 24.

The playback control toolbar







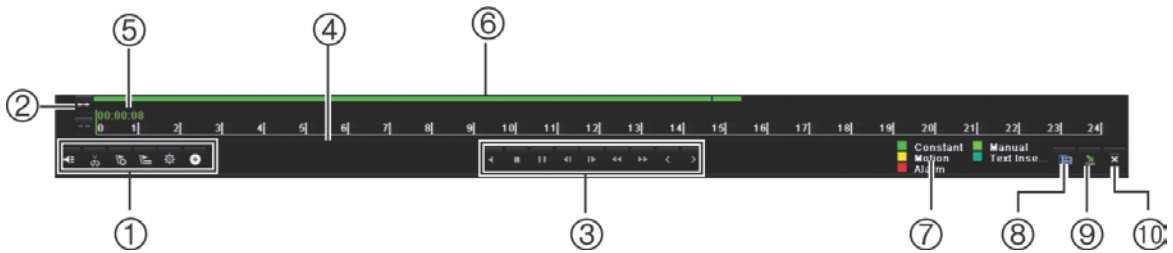

It is easy to manually control playback using the playback control toolbar. See Figure 24 below.

Note: The control toolbar does not appear for instant playback.

Figure 24: Playback control toolbar (All-day playback example shown)



Item	Description
1.	Audio and video control toolbar:
	/ Audio on/off.
	/ Start/stop a video clip during playback. Sections of a recording can be saved to an external storage device.
	Add default bookmark
	Add customized bookmark
	Bookmark management. Click to see the list of bookmarks and their times.
	Archive files

Item	Description
2.	Zoom control: Zoom in and out of the timeline to show the progress bar in greater or lesser detail.
3.	Playback control toolbar:
	 Reverse play the recording. Click again to pause.
	 Stop playback. Timeline jumps back to 00:00 time (midnight).
	 Play recording.
	 Forward skip by 30 seconds.
	 Reverse skip by 30 seconds.
	 Decrease playback speed: Options available are: single frame, 1/8 speed, 1/4 speed, 1/2 speed, normal, X2 speed, X4 speed, X8 speed, maximum speed.
	 Increase playback speed. Options available are: single frame, 1/8 speed, 1/4 speed, 1/2 speed, normal, X2 speed, X4 speed, X8 speed, maximum speed.
	 Previous file/day/event recording.
	 Play next file/day recording in the search result.
4.	Timeline: Allows you to jump forwards or backwards in time. The timeline moves left (oldest video) to right (newest video). Click a location on it for where you want playback to start. In all-day playback the cursor shows the actual time. In search playback, the cursor is a ball.
5.	Time bar: Time of actual playback. This is only displayed in all-day playback.
6.	Playback progress bar: This bar displays how far playback of the recording has progressed. It also indicates the type of recording.
7.	Recording type: Description of the color coding of recording types that appear in the playback progress bar. Dark green indicates continuous recording Red indicates alarm/event recording Yellow indicates motion recording Light green indicates manual recording Pale blue indicates text insertion recording
8.	Hide the playback control toolbar.
9.	Video search: This icon is only displayed when you play back the result of a search or for all-day playback. Click it to return to the Search window and reselect the search criteria.
10.	For all-day playback mode, quit playback and return to live view. For playback from search mode, quit playback and return to the search window.

Playback pop-up menu

You can quickly access many playback functions by placing the cursor on a playback image on screen and clicking the right-button of the mouse. The playback pop-up menu appears (see Figure 12 below).

Figure 25: The playback pop-up menu

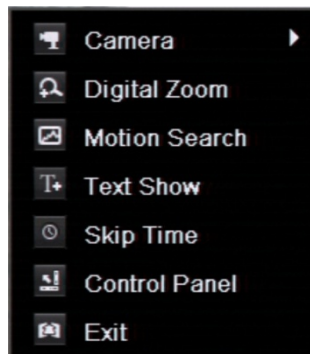

Item	Name	Description
1.	Camera	Select a camera for playback.
2.	Digital zoom	Enter the digital zoom function for the selected camera.
3.	Motion search	Call up the motion search toolbar to search playback recording for incidents of motion detection. See “Motion search” on page 65 for more information.
4.	Text show	Display inserted text on screen.
5.	Skip time	Modify the playback skip time. See “Playback skip time” on page 65 for more information.
6.	Control panel	Hide the playback control toolbar.
7.	Exit	Return to live view.

Instant playback



Use the quick access toolbar to quickly replay recorded video for a preprogrammed time period. This can be useful to review an event that has just happened. Only one camera at a time can be selected. The default playback period is 5 minutes. You can change the programmed period from the Display Settings > Monitor > More Settings page.

To instantly replay recorded video:

1. In live view mode left-click the mouse on the desired camera image. The quick access toolbar appears. Click **Instant Playback** .
2. Select the desired camera from the drop-down list and click **OK**.

Playback starts immediately. The Instant Playback scroll bar appears under the selected camera.



3. Click **Pause**  on the toolbar to pause playback.
Click **Play**  to restart playback.
Click **Stop**  to stop playback and return to live view.

To change the instant playback time period:

1. Click **Display > Monitor > More Settings** in the menu toolbar.
2. Select the desired instant playback time: 5, 10, 20, or 30 minutes. The default time is 5 minutes.
3. Click **Apply**.

Previous-day playback

Use this option to play back recorded video from the previous day. Playback starts at midnight and runs for the 24-hour period. Previous-day playback is shown in full screen view. See Figure 24 on page 55 for a description of the playback control toolbar.

• Using the mouse:

1. In live view mode, right-click the mouse on the desired camera image. In the mouse toolbar click **All-day Playback**.

The playback window appears. By default, the camera is in full-screen mode.

2. To select more than one camera for multiview playback or to select playback from a different day, move the mouse to the right edge of the window. The camera list and calendar appear. Check the desired cameras and/or another day. Up to 16 cameras can be selected.

Playback starts immediately.

Note: A message appears if there are no recordings found during this period.

3. Use the playback control toolbar to manually control playback.
4. Click **Exit**  to return to live view.

– Or –

Right-click the mouse and click **Exit** from the mouse menu to return to the previous window.

• **Using the front panel:**

1. Select the camera for playback and press the **Replay** button. Playback from the selected camera starts immediately.

Note: Multiview playback is only available using the mouse. If live view was showing multiview, only the camera in the top-left channel on screen will be played back.

2. To select a different camera for play back, press the numerical button of the desired camera.
3. Click **Live** to return to live view.

Searching recorded video

You can easily search and play back recorded videos by time, events, bookmarks, and snapshots.

The Search window has four submenus that allow you to carry out different searches by theme:

Search type	Description
Normal	Search all recorded video by cameras, recording type, type of file protection (locked or unlocked), and time period.
Event	Search only event recorded files. Files can be searched by alarm inputs, motion detection, or POS/ATM text insertion. Note: Only motion detection and POS/ATM text insertion that have been recorded as events will be listed in this search. Motion and text insertion that is recorded as a non-event can be searched under the Normal menu.
Bookmark	Search only recorded files with bookmarks.
Snapshot	Search only recorded files with snapshots.

Search results

A search will usually produce a list of files, which may extend to several pages. The files are listed by camera, and then for each camera by date and time. The oldest file is listed first. See Figure 26 on page 60 for an example of a search.

Only one file can be played back at a time.

Figure 26: Example of a search result list

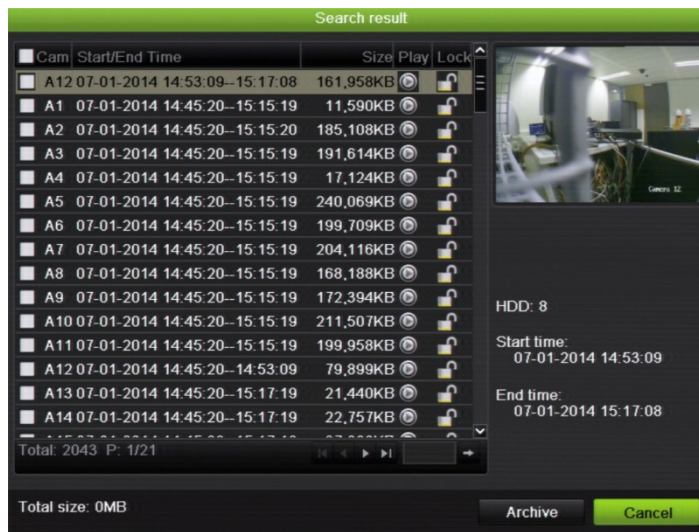



Playing back recordings by time and video type

You can search recorded video by time and video type, such as continuous recordings, motion, text insertion, alarm and all recordings. Video can be played back simultaneously across several cameras.

To play back search results:

1. In live view mode right-click the mouse and in the mouse menu select **Advanced Search > Normal**.
2. Click the channel icon and select the desired cameras, record type, file type as well as start and end time of the recording.
3. Click **Search**. The list of search results appears.
4. Play back the search results:

If there is only one camera in the search result, click its playback  button. Playback starts.

If there is more than one camera listed, click the playback  button of one of the cameras. In the window that appears, select the cameras you want to play back simultaneously and click **OK**. Playback starts.

5. To hide the playback control toolbar during play back, right-click the mouse and select the **Control Panel** button in the playback control toolbar. Click again for the panel to reappear.
6. Use the playback control toolbar to manually control playback.
7. To play back another camera, move the cursor to the right edge of the window to display the list of cameras and select the desired camera.
8. To do another search:

Click **Exit**  in the playback control toolbar to return to the search results window.

- Or -

Right-click the mouse and select **Exit** from the list to return to the search results window.

- Or -

Right-click the mouse and select **Video Search** from the list to return to the search window.

Playing back recordings by event

You can search recorded video by event type: motion, alarm input, and POS/ATM text insertion. Video can be played back simultaneously across several cameras.

To play back search results:

1. In live view mode, right-click the mouse and select **Advanced Search > Event**.
2. Select the desired event type as well as start and end time of the recording.
3. Select the desired alarm inputs.

If you selected "Motion" as the event type, select the required cameras. If you selected "Text insertion", select the required cameras and enter the desired keywords.

4. Click **Search**. The list of search results appears.
5. Play back the search results:

If there is only one camera in the search result, click its playback  button. Playback starts.

If there is more than one camera listed, click the playback  button of one of the cameras. In the window that appears, select the cameras you want to play back simultaneously and click **OK**. Playback starts.

6. To hide the playback control toolbar during play back, right-click the mouse and select the **Control Panel** button in the playback control toolbar. Click again for the panel to reappear.
7. Use the playback control toolbar to manually control playback.
8. To play back another camera, move the cursor to the right edge of the window to display the list of cameras and select the desired camera.
9. To do another search:

Click **Exit**  in the playback control toolbar to return to the search results window.

- Or -

Right-click the mouse and select **Exit** from the list to return to the search results window.



- Or -

Right-click the mouse and select **Video Search** from the list to return to the search window.

Creating and playing back bookmarked recordings

You can bookmark the important scenes in a recorded file for later reference.

Bookmarks flag the start of a scene. Up to 64 bookmarks can be saved in a video file. There are two types of bookmarks:

- **Default bookmark** : All default bookmarks have the same generic name, "Bookmark".
- **Customized bookmark** : The bookmark is given a name for easy identification. The same name can be used for several bookmarks.

Both types can be searched.

To create a bookmark:

1. Open an all-day playback window or the playback window from a search result.
2. In the all-day playback recording, click the timeline bar where you want the bookmark to be. The green time line jumps to this position. Click the button for the type of bookmark you want, and enter the bookmark name if required.

In the playback recording from a search, click the scroll bar where you want the bookmark to be. The scroll bar ball jumps to this position. Click the button for the type of bookmark you want, and enter the bookmark name if required. The bookmark is saved.

3. Click the bookmark management  button to see the list of bookmarks saved. The name of a bookmark can be edited. The bookmark can also be deleted.

To play back a bookmark:

1. In live view mode right-click the mouse and select **Advanced Search > Bookmark** in the mouse menu.
2. Select the desired cameras as well as start and end time of the recording to be searched. Also select the type of bookmark to be searched.



If searching for customized bookmarks, enter a keyword from the bookmark name.

- Click **Search**. The list of bookmarks appears.
3. Select a bookmark and do one of the following:
Click the **Edit** button to edit a bookmark's name.
Click the **Delete** button to delete a bookmark.
- Or -
Click the **Play** button to play back a bookmark.
 4. When finished, click **Exit**.

Slideshow of snapshots

You can search recorded for video snapshots. See "Accessing frequently used commands" on page 37 on how to create snapshots.

To play back search results:

1. In live view mode right-click the mouse and in the pop-up menu select **Advanced Search > Snapshot**.
2. Select the desired cameras as well as start and end time of the recording to be searched.
3. Click **Search**. The list of snapshots appears.
4. Select a snapshot to see it in the thumbnail window. Click its **Play**  button to see it in full-screen mode.
5. When in full-screen mode, move the cursor to the right edge of the window to see the complete list of snapshot s found in the search. Click their Play buttons to see them in full-screen mode.
6. To see a slideshow of all the snapshots found, click the ► or ◀ buttons on the snapshot toolbar to sequence forwards or backwards through the shots.
7. To do another search:
Click **Exit**  in the snapshot toolbar to return to the search results window.
- Or -
Right-click the mouse and select **Exit** from the list to return to the search results window.
- Or -
Right-click the mouse and select **Snapshot Search** from the list to return to the search window.

Playing back recordings from the system log

You can also playback recordings from the system log. The system log provides a much wider range of options for playback than Advanced Search, which deals with video detection and alarms only.

Figure 27: View log window



To play back video from the system log:

1. Click **System Settings > Log Search** in the menu toolbar.
2. Select the search start and end times.
3. Under **Major Type** and **Minor Type**, select an option from the drop-down list. The minor type list of options available depends on the option selected under major type.
4. Click the **Search** button. A list of results appears.
5. Select a file and click:
 - **Details:** Displays information on the log or recording. For a recording, it lists such information as start time, type of information, camera number, and gives a description on the types of events recorded and when record time was stopped.
 - **Play:** Click to start playback of the selected recording.
 - **Export:** Click to archive the selected file to a USB device. The export window appears.
 - **Back:** Click to return to the previous window.

Playback skip time

By moving the joystick up and down during playback, you can jump forwards or backwards by a defined skip time period.

To change the playback skip time:

1. In playback mode, right-click the mouse and click **Skip Time** on the pop-up menu. The Skip Time menu appears.
2. Select a skip time between 10 and 300 seconds. The default skip time is 30 seconds.

Motion search

You can quickly and easily search playback recording for incidents of motion detection. Motion can be searched over the whole playback window or just for specific areas on it. This allows you to search, for example, whether any motion was detected a few days ago near a particular door.

The option is not available in instant playback.

Figure 28: Motion search toolbar

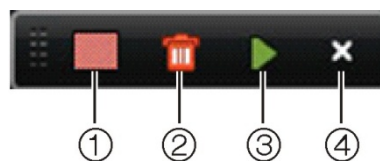

1. **Full screen detection:** The motion-sensitive red grid automatically appears over the whole window.
2. **Delete all:** Delete the motion grid.
3. **Search:** Search the playback recording for motion detection.
4. **Exit:** Quit motion search mode and return to play back.

To search for motion in playback:

1. In playback mode, right-click the mouse and click **Motion Search** on the mouse menu. The motion search toolbar appears and the playback control toolbar disappears.

2. Select an area of the window to be searched:

Drag the mouse over the desired area. A red grid appears. More than one area can be selected.

- Or -

Click the full-screen detection icon in the toolbar. The whole window is covered in the red grid.

3. Click the **Search** icon to see the results.

Motion appears as blue lines below the green playback progress bar. If motion had been recorded as an event, it appears as yellow on the progress bar.

Click the **zoom-in** button to see the progress bar in closer detail.

Playing back frame-by-frame

You can easily play back a selected video at different speeds. This allows you to carefully examine an event frame-by-frame as it happens.

To play back frame-by-frame:

• Using a mouse:

1. In playback mode click the **Speed Down**  button in the playback control toolbar until the speed changes to single frame.
2. Click the **Pause** button to advance the video frame by frame.

• Using the front panel:

1. In playback mode move the joystick to left and right to scroll down through the speed changes until single frame.
2. Press **Enter** with the joystick to advance the video frame by frame.
3. Press the **Playback** button to continue playback at normal speed.

Digital zoom in playback

You can easily zoom in on an image during playback to see it in greater detail.

To digitally zoom-in during playback:

1. In playback mode right-click the mouse and click **Digital Zoom** in the pop-up menu. The playback control toolbar disappears.
2. Click the screen with the cursor.

The image zooms in and the digital view window appears.

3. Left-click the mouse and drag the red square to the area of interest, or move the joystick on the front panel to position the red square. The selected area is magnified.
4. Right-click the mouse to quit the digital zoom mode and to return to full-screen playback mode. The playback control toolbar reappears.

Chapter 8

Archiving recorded files

Archive recorded files on an external device such as a USB flash drives, USB HDDs, eSATA HDD or a DVD writer. You must be in live view mode to archive video. Access to archive commands may require a password.

Before starting to archive files, ensure that you have the backup device connected to the DVR. It can be detected automatically by the DVR.

Note: The USB port on the back panel does not support USB CD/DVD burners or USB HDDs.

Archiving files

There are three ways to archive files from live view:

Quick Archive button: Quick archive lets you archive recorded files quickly by using the Archive button on the front panel. The TVR 42 then downloads all the recorded files on the unit to fill the available memory space on the storage media. This option is not available via the mouse.

Advanced Search window: Use the Export command in the Advanced Search window to specify archiving settings such as a specific time and date period, recording type, start and end times, as well as cameras.

Auto archive: You can schedule when to automatically archive recorded files.

Using Quick Archive

To archive recorded video using Quick Archive:

1. Insert the backup device into the DVR.

If using a USB memory drive, insert the device into the USB port on the front panel. If using a digital video disk (DVD) or eSATA drive, insert the disc into the DVD drive. If more than one media type is found in the TVR 42, the USB device takes precedence over the others.

2. Press **Archive** on the front panel or remote control to open the quick archive window.

3. From the list of files displayed, select the files you want to archive.
4. Click **Start** or press **Archive** again on the front panel. The unit starts to download all the files listed.

Note: If there is a capacity limitation on the backup device, only the most recent files will be backed up.

A message will appear to confirm when the download is complete.

Exporting recorded files to a backup device

There are two ways to archive files to a backup device. You can manually select the files to back up or you can schedule when the DVR will automatically archive.

You can insert a mini-USB hub to the USB port to attach a mouse for navigation or a USB drive for archiving. However, the unit may not support all types of USB hubs.

The Archive options available may depend on the type of backup device selected.

Figure 29: Example of an archive



Item	Function	Description
1.	Device name	Select one of the storage media for archiving. If the backup device is not recognized: <ul style="list-style-type: none"> • Click the Refresh button • Reconnect device • Check for compatibility from vendor
2.	Refresh	Refresh the search results if any parameters have been modified.
3.	Name	Files found on the backup device are listed.

Item	Function	Description
4.	Delete	Click to delete a selected file from the backup device.
5.	Play	Click to play selected file.
6.	Free space	Free space available on the backup device is displayed.
7.	Seal disc	Select to prevent other files being recorded onto the disc.
8.	Include Player	Select to automatically include the Player tool when archiving files.
9.	New folder	Create a new folder on the backup device. Files from the DVR can be archived to a specific folder.
10.	Format	Format the USB/eSATA drive.
11.	Archive	Start downloading selected files onto the backup device.
12.	Cancel	Cancel search and return to previous menu.

To manually export recorded files to a backup device:

1. Connect the backup device to the DVR.

If using a USB memory drive, insert the device into the USB port on the front panel. If using a digital video disk (DVD) or eSATA drive, insert the disc into the DVD drive. If both media are found in the TVR 42, the USB device takes precedence over the DVD.

2. In live view mode press the **Search** button on the front panel or remote control.

- Or -

Right-click the mouse and select **Advanced Search**.

The Advanced Search window appears.

3. Select the cameras and search parameters required:

Record type: All, constant, motion, text insertion, alarm, or manual.

File type: All, locked, or unlocked.

4. Select the start and end dates and times to archive recordings.

Note: You can click the **Quick Playback** button to verify that the selected files are the files to export. Right-click the mouse and click **Exit** to return to the Advanced Search window.

5. Click **Search**. The list of results appears.

6. Select the files to export.

7. Click **Archive**. The Archive window appears.

8. Select the storage medium to export to from the drop-down list.

9. Click **Archive** to begin the backup process.

10. Click **OK** when archiving is completed. Click **Cancel** until you return to live view.

Auto archiving

You can schedule the DVR to automatically archive recordings at set interval times to an external storage device. You can also select the cameras and recording types to auto archive as well as define how the system responds when the HDD becomes full.

It is easy to see the time of the most recent and next archive recording. Simply select the Archive Status tab and the information is displayed.

To schedule automatic archiving:

1. Connect the backup device to the DVR.
2. In the configuration menu, click **Video Schedule > Auto Archive > Archive Settings**.



3. Check **Enable Auto Archive**.
4. Select the start and end date and time periods during which archiving can occur automatically.
5. Under **Interval**, select the desired interval time for archiving.
The interval time options available are: 1 hour, 2 hours, 4 hours, 8 hours, 24 hours, or Once Only. Default is 1 hour.
6. Click **Archive File**. In the window that appears, select the cameras and search parameters required:
Record Type: All, constant, motion, text insertion, alarm, or manual.
File Type: All, locked, or unlocked.
Note: You can copy these selected parameters to other cameras. Click **Copy** and select the desired cameras.
Click **OK** and **Apply** to save, and return to the Archive Settings window.
7. Under **Device Full Rule**, select how the DVR responds if the backup device becomes full. There are two options: Stop Archiving (default) or Overwrite.
If overwrite is selected, the oldest files are overwritten.
8. Under **Device Select**, select the backup device used.

9. If you change any options, click **Refresh**.
10. Click **Apply**.



Creating and archiving video clips

You can save important scenes in a recorded file for later reference by creating video clips of selected portions of the file during playback. When an intruder, for example, crosses in front of several cameras you can save the video clip of the intruder's path across these cameras in a single file.

Up to 30 video clips can be made from a recording.

Note: This feature is only available using the mouse.

To manually export video clips during playback:

1. Connect the backup device to the DVR.
2. Search for the required files to play back. See "Searching recorded video" on page 59.
3. Select the file or files to play back and click **Play**. Playback starts immediately.
4. Click the playback timeline where you want the video clip to start and click the **Start Clip**  button.
5. Click the playback timeline where you want the video clip to stop and click the **End Clip**  button.
6. Repeat for additional clips.
7. Exit playback mode. A message appears asking if you want to save the video clips.
8. Click **Yes** to archive the clips. The Export window appears.
Click **No** to exit and return to the search results window. The clips are not saved.
9. In the Archive window select from the drop-down list the backup device to be used.
10. Click **Start**. File downloading starts.

Note: You can create a new folder for the video clips. Press the **New Folder** button and enter the folder name.

Archiving snapshots

You can save all the video snapshots recorded to a backup device.

To manually archive snapshots:

1. Connect the backup device to the DVR.
2. Search for the required snapshot files to play back. See “Slideshow of snapshots” on page 63. The list of snapshots appears.
3. Select the snapshots to backup.
4. Click **Archive**. Select the archiving device, if different from that listed.
5. Click **Archive**. Export starts immediately.
6. When completed, click **OK**. Click **Cancel** to return to the previous window.

Managing backup devices

You can manage backup devices from the Archive window (see Figure 29 on page 68.)

The Archive window allows you to:

- **Create New Folder:** Create a new folder on the backup device.
- **Delete:** Delete a file or folder from the backup device.
- **Play:** Play the selected video file from the backup device.
- **Format:** Format the backup device.
- **Erase:** Erase files from a re-writable CD/DVD.

Playing back archived files on a PC

Use the standard file player software to play back the archived video on your PC. It is downloaded automatically from the TVR 42 when archiving files onto a backup device.

Chapter 9

Using the web browser

This chapter describes how you can use the web browser interface to configure the device, play back recorded video, search through event logs, and control a PTZ dome camera. You can also specify settings on the web browser interface to optimize video playback and recording performance when operating in a low or limited bandwidth environment.

Windows Vista and 7 users

Internet Explorer for Windows Vista and Windows 7 operating systems have increased security measures to protect your PC from any malicious software being installed. When using the TVR 42 web browser interface, you can install ActiveX controls to connect and view video using Internet Explorer.

To have complete functionality of the web browser interface and the DVR player with Windows Vista and Windows 7, do the following:

- Run the browser interface and the DVR player application as an administrator in your workstation
- Add the DVR's IP address to your browser's list of trusted sites

To add the DVR's IP address to Internet Explorer's list of trusted sites:

1. Open Internet Explorer.
2. Click **Tools**, and then **Internet Options**.
3. Click the Security tab, and then select the Trusted Sites icon.
4. Click **Sites**.
5. Clear the "Require server verification (https:) for all sites in this zone" box.
6. Enter the IP address or DDNS name in the "Add this website to the zone" field.
7. Click **Add**, and then click **Close**.
8. Click **OK** in the Internet Options dialog window.
9. Connect to the TVR 42 for full browser functionality.

Accessing the web browser

To access the TVR 42, open a web browser and enter the IP address assigned to the DVR as a web address. On the logon window, enter the default user ID and password.

Note: Only one DVR can be viewed per browser.

User ID: admin

Password: 1234

The default values for TVR 42 network settings are:

- IP address - 192.168.1.82
- Subnet mask - 255.255.255.0
- Gateway address - 192.168.1.1
- Ports:

When using the browser:

RTSP port: 554

HTTP port: 80

When using TruNav:

RTSP port: 554

Server/Client software port: 8000

For more information on port forwarding, see Appendix C “Port forwarding information” on page 146.









Web browser overview





The TVR 42 web browser lets you view, record, and play back videos as well as manage all aspects of the DVR from any PC with Internet access. The browser’s easy-to-use controls give you quick access to all TVR 42 functions. See Figure 30 below.

Figure 30: Live view in the web browser interface



Table 15: Description of live view in the web browser

Item	Name	Description
1.	Camera	View video and record video from the selected camera.
2.	Menu toolbar	Lets you do the following: <ul style="list-style-type: none"> View live video Play back video Search for event logs Configure settings Log out of the interface
3.	Viewer	View live or playback video.
4.	Display format	Define how you want video to be displayed in the viewer: <ul style="list-style-type: none">  Multiview  Full screen
5.	Video function toolbar	Lets you do the following in live view: <ul style="list-style-type: none">  Switch between main stream and substream.  Start/stop all streaming from selected cameras.  Start recording from selected cameras.  Access digital zoom.  Turn POS/ATM text insertion on/off.  Take a video snapshot.

Item	Name	Description
		 View previous camera: If viewing in multiview format, live view moves to the previous group of cameras for the selected number of video tiles.
		 View next camera: If viewing in multiview format, live view moves to the next group of cameras for the selected number of video tiles.
		 Turn audio on/off.
		 Open/stop bi-directional audio.
6.	PTZ panel	Hide/display the PTZ panel.
7.	Alarm center	Display a log of unacknowledged alarms.
8.	Language selection	Select the desired language from the drop-down list.

Using the web browser to configure the device

Click **Configuration** on the browser menu bar to display the configuration window. There are two ways to configure the DVR: Local and Remote.

Local configuration

Local configuration lets you define communication and network parameters such as protocol type, maximum file size, stream type and network transmission settings. You can also specify the directory locations for saving recorded and playback video, snapshots, and downloaded files.

Remote configuration

See Figure 31 below for an example of the Configuration window. See Table 16 on page 75 for an overview of the different browser menu functions. Please refer to the specific sections on the OSD menu functions for more information on configuring these functions.

Note: The configuration settings defined remotely are different from those that can be defined locally.

Figure 31: Remote browser configuration (Device Parameters – Device Information window shown)

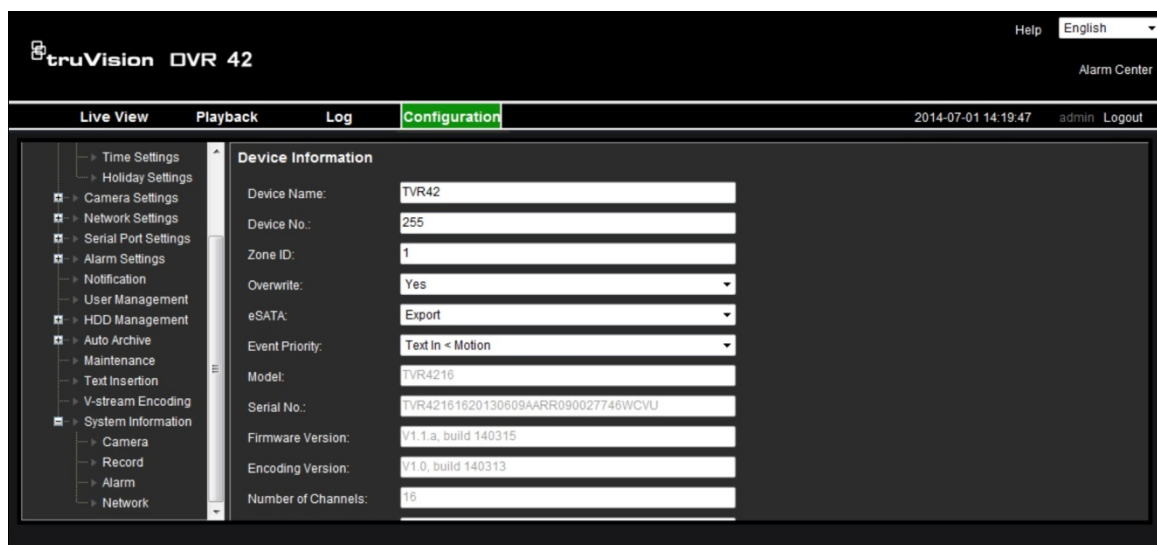

Table 16: Description of remote configuration menus

Menu	Function	Description
Device Parameters	Device Information	<p>Device name: Define the DVR name. The default name is TVR 42.</p> <p>Device number: The device number to use for the DVR when programming the remote control. The default value is 255.</p> <p>Zone ID: Each DVR in a daisy chain must have a unique zone ID so that it can be controlled by a KTD-405. The default value is 1.</p> <p>Overwrite: Enable or disable. Enabling this setting causes recorded files to be overwritten once the HDD is full.</p> <p>eSATA: Define how an external recording device saves records. See “Using an external recording device” on page 92 for more information.</p> <p>Event priority: Define the priority between text insertion event and motion alarm if both are triggered at the same time. Default is Motion alarm (Text In < Motion).</p>
	Time Settings	Define time and date. See “Configuring time and date” on page 42 for more information. See “Configuring an NTP server” on page 114 for information on setting up NTP time settings.
	Holiday Settings	Define when recordings occur during holiday periods. See “Holiday schedules” on page 95 for more information.
Camera Settings	Display Settings	Define which information is displayed on-screen. See “Configuring the camera OSD settings” on page 128 for more information.
	Video Settings	Define general recording settings. See “Defining a recording schedule” on page 93 for more information.

Menu	Function	Description
	Recording Schedule	Define the recording schedules. See “Defining a recording schedule” on page 93 for more information.
	Motion Detection	Define motion detection parameters. See “Setting up motion detection” on page 103 for more information.
	Privacy Mask	Define the on-screen privacy mask areas. See “Setting up privacy masking” on page 129 for more information.
	Tamper-proof	Define the video tampering detection settings. See “Detecting video tampering” on page 110 for more information.
	Video Loss	Define the video loss detection settings. See “Detecting video loss” on page 109 for more information.
	Text Overlay	Add extra lines of text on screen. See “Text overlay” on page 86.
	Image	Adjust image quality on screen. See “Adjusting camera image settings” on page 130 for more information.
	Covert Camera	Define the cameras whose images cannot be displayed by those not logged in. See “Hiding a camera image from view” on page 130” on page 130 for more information.
	Capture Settings	Define the resolution and image quality of snapshots.
	Manual Record	Define which cameras can manually record. See “Manual recording” on page 95 for more information.
Network Settings	General	Define the general network settings. See “Configuring general network settings” on page 111 for more information.
	PPPOE	Define the PPPoE settings. See “Configuring PPPoE” on page 112 for more information.
	DDNS	Define the DDNS settings. See “Configuring DDNS” on page 113 for more information.
	Email	Define the settings to send an e-mail. See “Configuring e-mail” on page 114 for more information.
	Network Storage	Define the remote storage system for DVR recordings. See “Using a network storage system” on page 87 for more information.
	UPnP	Enable this function so that the DVR can automatically configure its own port forwarding. See “Configuring UPnP” on page 115 for more information.
	SNMP	Define the SNMP settings. See “Configuring SNMP” on page 116 for more information.

Menu	Function	Description
	FTP	Define the FTP settings. See “Configuring an FTP server to store snapshots” on page 116 for more information.
	More Settings	Define a remote alarm host, multicast IP as well as the server, HTTP and RTSP ports. See page 117 for more information.
Serial Port Settings	232 Serial Port	Define the RS-232 parameters. See “Configuring the RS-232 port” on page 132 for more information.
	485 Serial Port	Define the RS-485 parameters.
Alarm Settings	Alarm Input	Define the alarm input parameters for when an external alarm is triggered. See “Setting up external alarms” on page 106 for more information.
	Alarm Output	Define the response when an external alarm is triggered. See “Setting up external alarms” on page 106 for more information.
	Alarm Audio	Define the parameters to import an alarm audio file. See “Alarm audio messages” on page 101.
	Audio Output	Define the parameters to import an alarm audio file. See “Alarm audio messages” on page 101.
	Advanced Settings	Define the warning buzzer time. See “Modifying the warning buzzer” on page 103 for more information.
Notification		Define the notification parameters when irregular events occur such as HDD full. See “Description of alarm notification types” on page 100 and “Setting up system notifications” on page 108.
User Management		Define, modify, and delete users. See Chapter 16 “User management” on page 139 for more information.
HDD Management	Basic Settings	Initialize the HDD. See “Initializing HDDs” on page 121 for more information.
	Storage Mode	Define the storage capacity of the HDD. See “Controlling disk space on the HDD” on page 121 for more information.
	SM.A.R.T. Settings	List the S.M.A.R.T. information on the HDD.
Auto Archive	Archive Settings	Define archive scheduling as well as camera and recording type selection. See “Auto archiving” on page 70 for more information.
	Archive Status	Review archive status. See “Auto archiving” on page 70 for more information.
Maintenance		Remotely update the DVR firmware, restore default factory settings, restart the DVR, and import parameters remotely. See Chapter 15 “DVR management” on page 132 for more information.

Menu	Function	Description
Text Insertion		Define access device, access mode, and start string. See “Capturing text insertions” on page 84.
V-stream Encoding		Define the maximum bit rate and frame rate. See “V-stream encoding” on page 46 for more information.
System Information	Camera, Record, Alarm, Network, and HDD	Review the status of the cameras, recordings, alarms, network, and HDDs. See “Viewing system information” on page 134 for more information.

Searching and playing back recorded video















To search and play back recorded video, click Playback on the menu bar to display the Playback page shown in Figure 32 below.

Figure 32: Browser playback page



Description

- Selected camera.
- Calendar:** Selected day is highlighted.
- Search:** Click to start searching recorded files for the selected camera.
- Dual stream:** Select desired dual stream mode: Main stream, substream, or picture. Default is main stream. See “Dual streaming” on page 82 for more information.
- By text:** Check to search text insertion when playing back a recorder video. Enter the keyword to search for in the text box that appears.
- Player Download:** Click to download the Player application required to play back recordings on your computer.
- Display format:** Click to change the display format: full screen or multiview display.

Description	
8.	Playback control toolbar:
	Reverse: Click to reverse playback. Only one channel can be shown on-screen at a time.
	Play/Pause: Play or pause playback.
	Stop playback. Timeline jumps back to 00:00:00 time (midnight) of the previous day.
	Speed down: Click to scroll through the different speeds available: single frame, 1/8 speed, 1/4 speed, 1/2 speed, normal, X2 speed, X4 speed, X8 speed, maximum speed. Current speed is displayed under the camera name on top right of window.
	Speed up: Click to scroll through the different speeds available: single frame, 1/8 speed, 1/4 speed, 1/2 speed, normal, X2 speed, X4 speed, X8 speed, maximum speed. Current speed is displayed under the camera name on top right of window.
	Single frame: Click to play back one frame at a time.
9.	Timeline: The timeline moves left (oldest video) to right (newest video). Click a location on the timeline to move the cursor to where you want playback to start.
10.	 Stop streaming: Stop streaming from all cameras.
11.	Type of recording: Green: Indicates video recorded based on the recording schedule defined. Red: Indicates video recorded that was triggered by an alarm recording. Yellow: Indicates video recorded that was triggered by motion detection. Blue: Indicates video recorded that was triggered by a POS/ATM text recording. Pale green: Indicates manually recorded video.
12.	Audio and video control toolbar:
	Digital zoom: Access digital zoom. See “Digital zoom in playback” on page 66 for further information.
	Text insertion: Click to enable/disable POS/ATM text display in playback.
	Snapshot: Capture a snapshot of the video.
	Start/stop Clipping: Start/stop video clip during playback. Sections of a recording are saved to a local computer folder.
	Download: Download video clips.
	Backup: Click to make back up of recorded files to save locally on the DVR. A list of the recorded files appears
	Audio: Click to enable/disable audio.
	Bookmark Management: Manage bookmarks.
13.	Jump start: Enter a precise time in the box and click the Go To button to jump start the playback at this selected time.
14.	Zoom in or out: Click an icon to zoom in or out of the timeline. By default the timeline displays a 24-hour period. Continue clicking the zoom-in icon to see up to a five-minute period.

Select a camera and a day to search from on the calendar displayed, and then click **Search**. The timeline below the window indicates video recorded for the specified day. The timeline also classifies by color the type of recording.

Click and drag the marker across the timeline on where you want video playback to begin, and then click **Play** on the playback control toolbar. You can capture a snapshot of a video image, save the video playback, or download the recorded video.

Searching for event logs

The DVR compiles a log of events, such as the start or end of video recording, DVR notifications, and alarms, through which you can easily search. Logs are categorized by the following types:

- **Alarm:** Includes motion detection, tamper detection, and other alarm events
- **Notifications:** Includes system notifications such as video loss, HDD failures, and other system-related events
- **Operations:** Includes users access to the web interfaces and other operational events
- **Information:** Includes general information on the DVR actions, such as the start and end of video recording, etc.

To search for logs, click the **Log** tab in the browser toolbar, select a log type, specify a date and time range, and then click **Search**.

Dual streaming

The DVR allows you to view from up to 16 cameras over a network. Dual streaming allows high quality video to be viewed in one stream (Main stream) and lower quality video to be viewed in another stream (substream) that can be easily streamed through a narrow bandwidth.

The normal stream has the frame rate, quality, and resolution as configured in the encoding menu. However, in a thin stream data thinning has been carried out so that it has a lower frame rate, quality, and resolution. This allows more video to be recorded on the HDD.

Dual streaming is available in both live and recording modes.

To play back dual streaming:

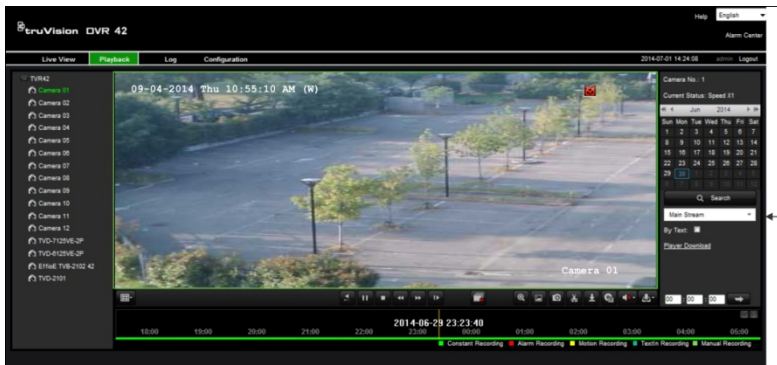

Select streaming option here

To record dual streaming:

1. In the browser toolbar, click **Configuration > HDD Management > Storage Mode**.

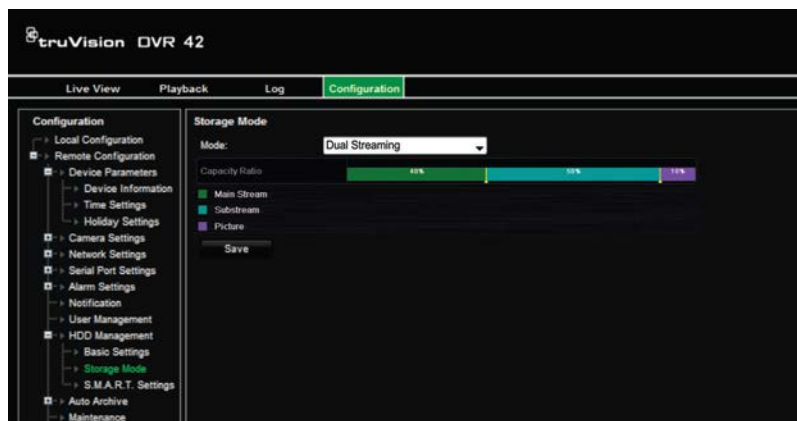

2. Under Mode, select **Dual Streaming**.
3. Specify which percentage of the HDD should be used to store main streams, substreams, and snapshots (Pictures).

Using the mouse, drag the markers between the colored sections to the desired values. The minimum and maximum values for each recording type are:

Main stream: 20 to 50%

Substream: 30 to 60%

Picture: 0 to 20%

4. Click **Save** to save the settings.

Controlling a PTZ dome camera in the web browser

The web browser interface lets you control the PTZ functions of a dome camera. Click a PTZ dome camera and use the PTZ controls on the interface to control the PTZ functions.

Figure 33: PTZ controls

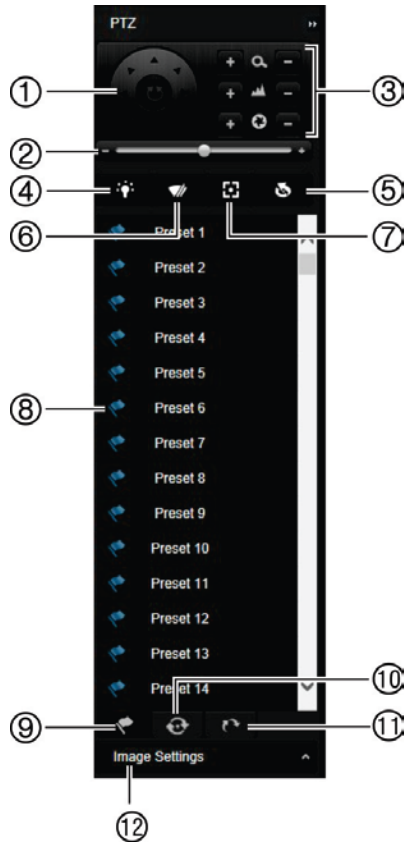

1. Directional pad/auto-scan buttons: Controls the movements and directions of the PTZ. Center button is used to start auto-pan by the PTZ dome camera.
2. Adjust speed of PTZ dome camera.
3. Adjust zoom, focus, and iris.
4. Turn on or off the camera light (if available on the camera).
5. Lens initialization: Initialize the lens of a camera with a motorized lens, such as PTZ or IP cameras. This function helps to maintain lens focus accuracy over prolonged periods of time.
6. Start or stop camera wiper (if available on the camera).
7. Auxiliary focus: Automatically focus the camera lens for the sharpest picture.
8. Start selected preset/tour/shadow tour (depending on function selected).
9. List presets available.
10. List preset tours available.
11. List shadow tours available.
12. Modify brightness, contrast, saturation, and hue values.

Capturing text insertions

Text insertion lets you insert or display text from a point-of-sale (POS) or ATM system on the video display of the DVR. The text is saved and time-stamped together with the video. You can then search the text for specific video clips. The text is displayed during playback.

The DVR supports POS and ATM text insertion via the UTC ProBridge accessory connected to the RS-232 port on the DVR. This feature is currently only available using the browser.

In both live view and playback, a camera set up for text insertion will display the video with the POS text overlay.

See Figure 34 below for an example of a video image in live view with text insertion.

Figure 34: Example of a video image with text insertion

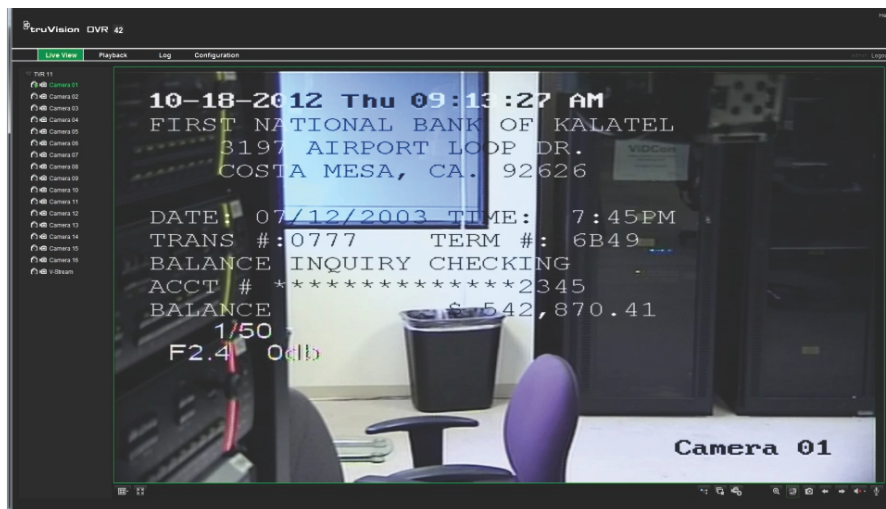

To set up text insertion:

1. In the browser toolbar, click **Configuration > Serial Port Settings > 232 Serial Port**.

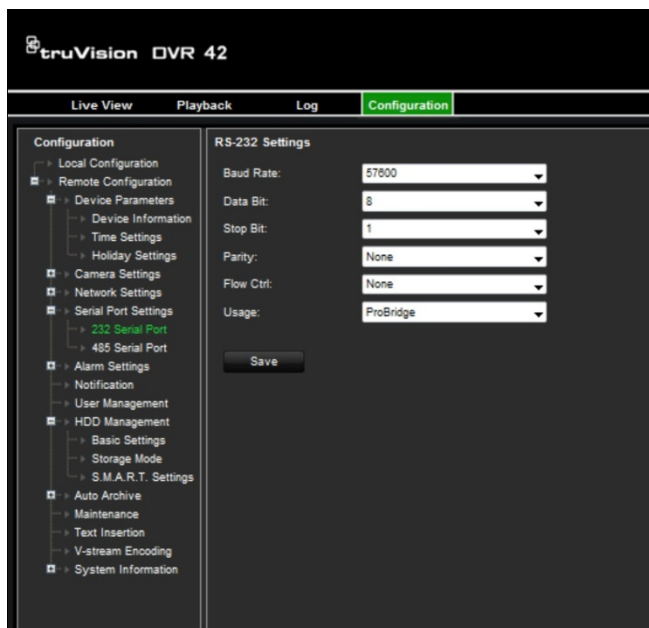

2. Under **Usage**, select ProBridge.
3. In the submenu panel, click **Auto Archive > Text Insertion**.

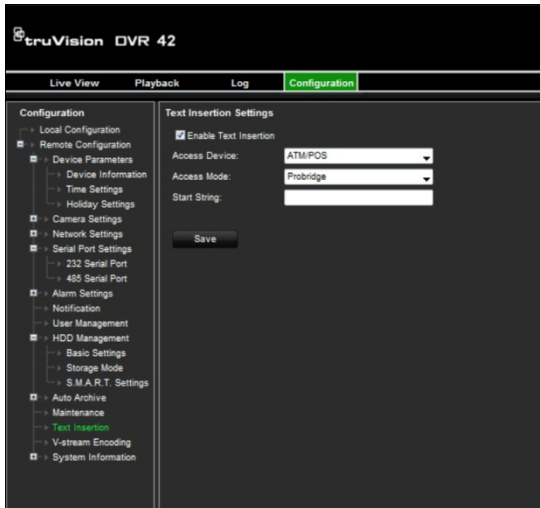

4. Check **Enable Text Insertion**.
5. Select the access device from the drop-down list.
6. Under **Access Mode**, select “ProBridge”.
7. Under **Start String**, enter the desired transaction text, such as an ATM transaction number.
8. Click **Apply** to save the settings.

To search text insertion in recorded video:

1. In live view, check the **By Text** check box.

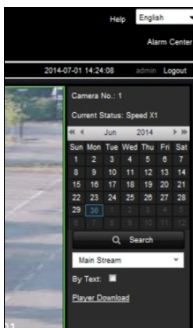

2. In the keyword text box that appears, enter the text for which you want to search.

Text overlay

You can add up to eight lines of text on screen via the browser. This option can be used, for example, to display emergency contact details. By default these lines of text are positioned along the top of the window. The strings follow each other consecutively.

Note: This option is not available via the DVR.

To add on-screen overlay text:

1. In the browser toolbar, click **Configuration > Camera Settings > Text Overlay**.

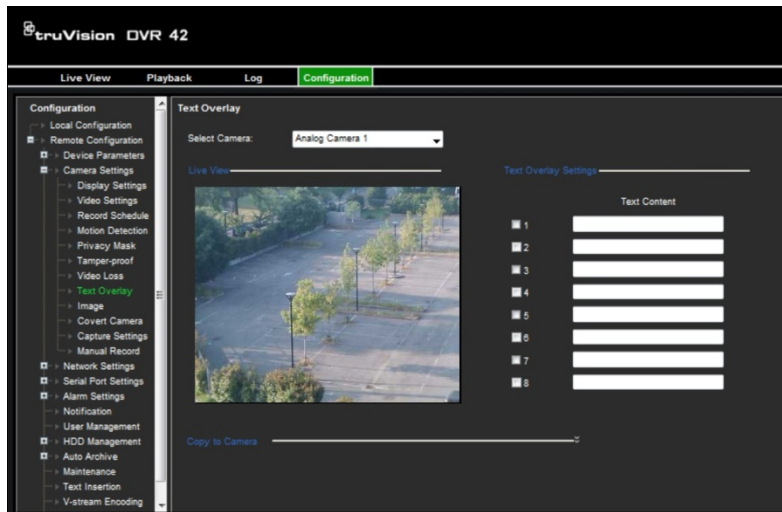

2. Select the desired camera.
3. Check the string box 1 for the first line of text.
4. Enter the text for string 1 in the column alongside. Up to 22 alphanumeric characters can be used.
5. Repeat steps 3 and 4 for each extra line of text, selecting the next string number.
6. Click **Save**.

Using a network storage system

You can use a network storage system (NAS) or storage area network (SAN) to remotely store DVR recordings.

To set up a network storage system:

1. In the browser toolbar, click **Configuration > Network Settings > Network Storage**.

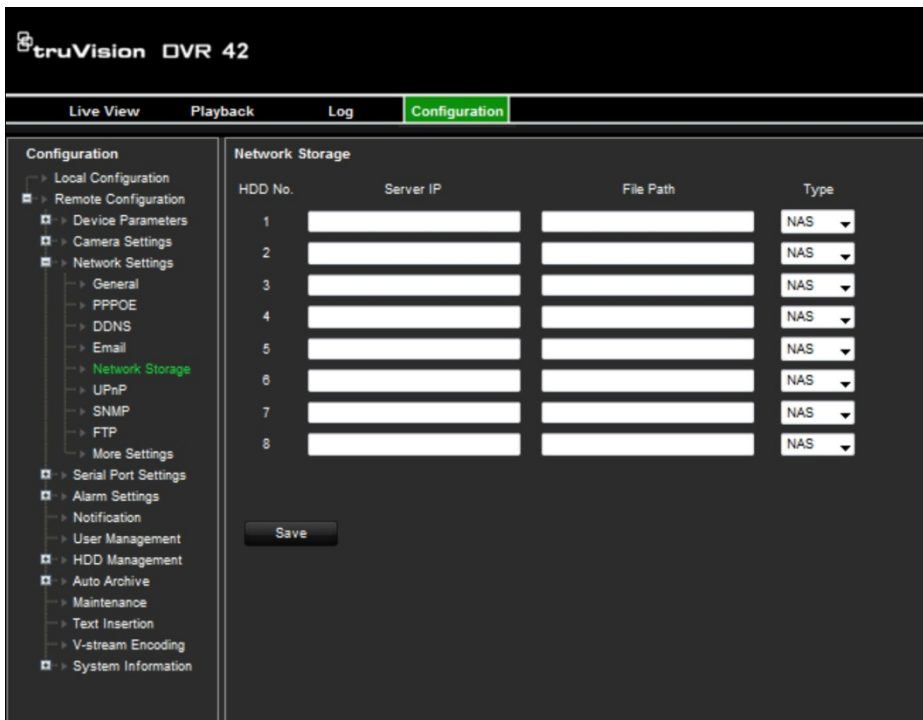

2. On the first line of HDD No., enter the IP address of the desired remote storage system.
3. Enter the file path name to define where on the remote storage system you want to store the files.
4. Under Type, select type of storage system to be used: NAS or SAN. Default is NAS.
5. Up to eight remote storage systems can be set up.
6. Click **Save**.

Chapter 10

Recording

This chapter provides instructions on how to define the recording settings of your DVR. This chapter covers how you can configure your initial recording settings, schedule recordings, protect your recorded files, and set up your HDD for redundancy.

Initializing recording settings

Before you can set up your DVR to begin recording, you must first configure general recording settings for the analog cameras.

Ensure that the HDD has been installed and initialized before configuring the recording settings. See Chapter 13 “HDD management” on page 121 for more information.

See “Calculating the maximum permitted frame rates and bit rates” on page 91 to calculate the maximum frame and bit rates.

To configure recording settings:

1. From the menu toolbar, click **Video Schedule > Encoding > Record**.



2. Select the camera you want to configure.
3. Configure the following recording settings:
 - **Encoding Parameters:** Select one of the stream types: Mainstream (TL-Hi, Mainstream (TL-Lo), Mainstream (Event), Mainstream (Alarm), or Substream.
 - **Stream Type:** Select the type of stream to record, either video or video and audio.
 - **Resolution:** Select the resolution of the recording. Options include: WDR, 4CIF, 2CIF, CIF, and QCIF.
 - **Bit rate Type:** Select Constant or Variable.
 - **Video Quality:** Select the quality at which to record. If “Variable” was selected as the bit rate type, this option is unavailable.
 - **Frame Rate:** Select the recording frame rate.
 - **Max Bitrate Mode:** Select the general default or customized option.
 - **Max Bitrate (Kbps):** If the customized maximum bit rate mode was selected, enter the value here. It must be between 32 and 4096 kbps. It is calculated from the frame rate and time required.
 - **Pre-record:** This is the time the camera starts recording before the event. Select the time in seconds to start pre-recording before the event.

The maximum pre-recording times available depend on the constant bit rate. See “Maximum pre-recording times” on page 156 for more information.

- **Post-record:** This is the time the camera continues to record after the event. Select the time in seconds to stop post-recording after the event.
- **Auto Delete (day):** Select the number of days after which recorded video from the specified camera is permanently deleted from the HDD. A “day” is defined as the 24-hour period from when the auto delete mode (ADM) was set.

The maximum number of days that can be set is 60. However, the actual number of days permitted depends on the HDD capacity. If the value is set to ‘0’, the option is disabled.

- **Redundant Record/Capture:** Select the camera to be used for redundancy. Default is No. See “HDD redundancy” on page 98 for more information.
 - **Record Audio:** Select **Yes** to record sound with the images.
4. Click **Apply** to save the settings.
 5. If you want to save these parameters to another camera, click **Copy** and select the camera in the pop-up screen that appears. Click **OK** and return to the main window.
 6. Click the **Capture** tab and configure the settings for captured video, such as snapshots. Click **Apply** to save the settings.
 7. Click **Back** to return to live view.

Calculating the maximum permitted frame rates and bit rates

You can easily calculate the correct frame rates, bit rates, and HDD free space required for your system.

Note: If you should later change any recording parameters, the calculated values will no longer apply.

To configure recording settings:

1. From the menu toolbar, click **Video Schedule > Encoding > Encode Parameters Recommendation**.
2. Enter the number of days to be recorded (1) and the resolution (2). Also specify whether the recording period will include weekdays and weekends (3).



3. Click **Calculate**. The recommended maximum values for the frame rate, bit rate, and HDD free space are then displayed.

Use this information when setting the recording parameters.

Note: This option is not available via the browser.

Using an external recording device

You can use an external storage device, such as an eSATA HDD, to backup video or to add its recording capacity to that of the DVR itself. If you change this option, you must reboot the DVR to implement the change.

To configure for an external recording device:

1. Click the **Video Schedule** icon in the menu toolbar.
2. Select **More Settings**.
3. Select one of the two options:
 - Record and Capture:** Extend the recording capacity of the DVR.
 - Export:** Backup data onto an eSATA backup device.

Note: If the external storage device is part of the total internal capacity of the DVR, then it is no longer available for backing up video.

4. Click **Apply**.

Configuring overwrite

You can select how the DVR responds when the HDDs become full and there is no longer sufficient space to save new data.

To configure for overwrite when the HDDs are full:

1. From the menu toolbar, click **Video Schedule > More Settings**.
2. Under **Overwrite**, select **Yes**.

Defining a recording schedule

Defining a recording schedule lets you specify when the DVR records video and under what circumstances. Each camera can be configured to have its own recording schedule.

The schedules are visually presented on a map for easy reference. See Figure 35 below for an example.

Figure 35: Description of the Schedule window

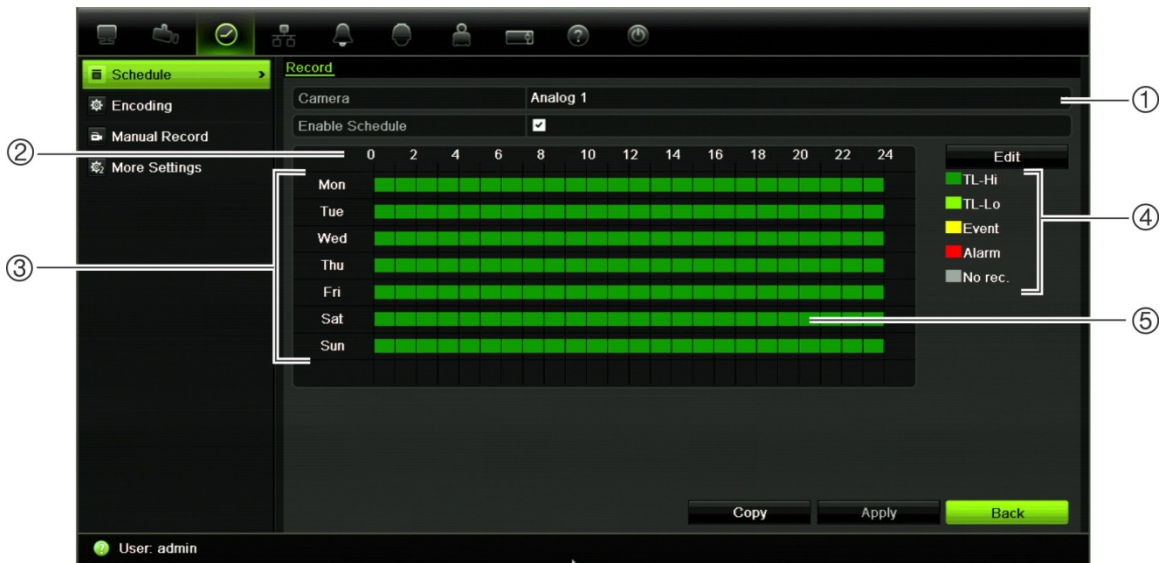

1. **Camera.** Select a camera.
2. **Schedule time.** Represents the 24-hour cycle during which a schedule is selected.
3. **Schedule day.** There are eight days to select: Sunday (Sun), Monday (Mon), Tuesday (Tue), Wednesday (Wed), Thursday, (Thu), Friday (Fri), Saturday (Sat) and Holiday (if Holiday has been enabled).
4. **Recording type.** There are five recording types to select, which are color-coded:
 - TL Time lapse (Green squares): Record of a specific day. Each green square in the timeline represents an hour in the 24-hour period.
 - TL-Hi (Dark green): High quality time lapse. Records high quality video.
 - TL-Lo (Bright green): Low quality time lapse. Records low quality video. This could be used, for example, for night recordings when few events or alarms are expected. Saving the video in low quality helps save resources on the HDD.
 - Event (Yellow): Records only events, such as motion detection and POS/ATM text insertion.
 - Alarm (Red): Records only alarms.
 - None (Grey): No recording during this period.
5. **Timeline.** There is a 24-hour time line for each day. Up to eight recording periods can be scheduled during the 24-hour period.

Daily schedules

To set up a daily recording schedule:

1. From the menu toolbar, click **Video Schedule > Schedule**.
2. Select a camera.
3. Check the **Enable Schedule** box.
4. Click **Edit**. The following window is displayed:

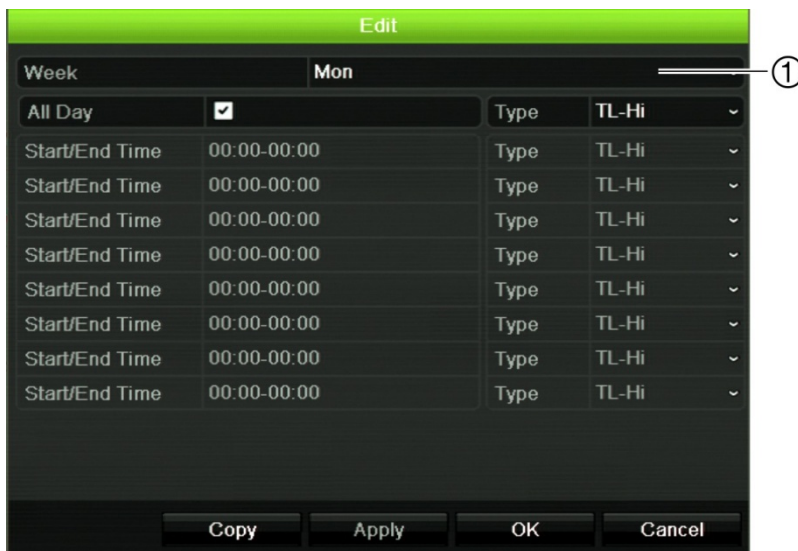

5. Select the day of the week (①) for which you want to set up the schedule.

You can define a different schedule for each day of the week.

Check **All Day** to select the whole week.

6. Set the start and end time for recording.

Define a time period by entering a start (left column) and end (right column) time. You can schedule up to eight time periods. Click **All Day** to record all day.

Note: The time periods defined cannot overlap.

7. Select a recording type.

This setting instructs the DVR to begin recording when an alarm is triggered. The recording type can be based on time and triggered by motion detection and/or an alarm. If set to TimeLapse (TL-Hi or TL-Lo), the DVR records continuously.

8. Click **Apply** to save settings.

9. Repeat steps 3 to 8 for other days of the week or to copy the schedule settings to another day.

To copy the current schedule settings to another day of the week, click **Copy**. Select the number of the day of the week to which to copy the schedule and click **OK** to save changes and return to the Edit window.

10. Repeat steps 3 to 9 for other cameras.
11. Click **Apply** to save the settings, and then **OK** to return to the schedule window.

Holiday schedules

As well as being able to schedule when recordings occur during the week, you can also schedule them for specific holidays in the year such as, for example, the first of January, or the second Wednesday of every month. You can schedule up to 32 holiday periods.

A holiday period can be scheduled for a particular day or as a block of days.

To set up a holiday recording schedule:

1. From the menu toolbar, click **Display Settings > Holiday**.
2. Select a holiday period from the list, and click **Edit** to modify the settings. The Edit window appears.
3. Enter the name of the holiday period, and click **Enable**.
4. Select whether the holiday period will be categorized by date, week or month, and then enter the start and end dates.
5. Click **Apply** to save the settings, and then **OK** to return to the Edit window.
6. Repeat steps 2 to 5 for other holiday periods.
7. Click **Back** to return to live view.

Manual recording

The DVR lets you manually record video during live view. This can be useful if you know that the DVR is not currently recording and you see something of interest on a camera window that should be recorded.

Once a manual recording is started, the recording continues until it is manually stopped. If an alarm occurs during a manual recording, the alarm recording has priority over the manual recording. If a scheduled recording is already in progress when a manual recording is started, it continues to record as scheduled.

You can check to see if a camera is recording manually by looking at the icon on the quick access toolbar. The icon is red when manually recording. Default is off.

There are two ways to start and stop a manual recording:

- **Use the quick access toolbar**

You can start/stop manual recording for each camera individually. Position the cursor over a camera image and left- click the mouse to display the quick

access toolbar. Click the manual record icon to start or stop manual recording. The icon is red when recording.

- **Use the configuration menu**

This option lets you select more than one camera at a time. Go to Video Schedule > Manual Record to access the manual recording menu and check the boxes of the cameras to start or stop manual recording.



Motion detection schedules

You can set up both the schedule and areas sensitive to motion detection for each camera individually or easily copy the settings of one camera to other cameras.

For information on scheduling motion detections, see “Motion detection set up” on page 103.

External alarm schedules

The DVR can be scheduled to record when an alarm is triggered by an external alarm device such as a PIR detector or dry contacts. For information on scheduling external alarms, see “Triggering or clearing alarm outputs manually” on page 108.

Protecting recorded files

There are two methods to prevent recorded files from being inadvertently overwritten or deleted off the HDD. We highly recommend that important recorded events be protected from deletion. Recorded files can either be *locked* or the HDD that the files reside on can be set to *read only*.

Locking and unlocking recorded files

Lock files to protect them against being overwritten or deleted.

To lock or unlock a recorded file:

1. In live view enter the video search window by pressing the **Search** button on the front panel or remote control, and then enter Advanced Search. Select the Normal tab.

— Or —

In live view right-click the mouse to display the pop-up menu and select **Advanced Search > Normal**.

The Search window appears.

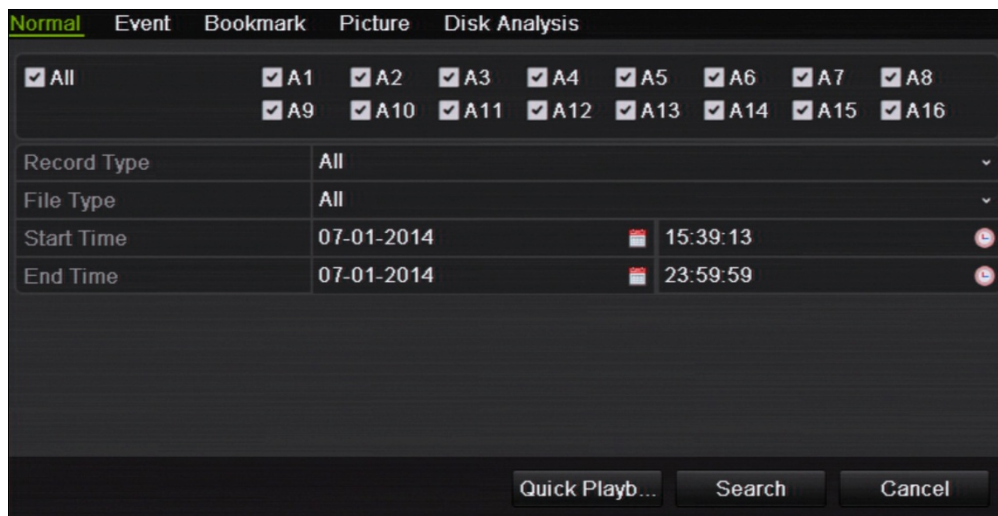

2. Search for the desired recording by entering the search parameters, which include the camera number, record type, file type, and start time and end time.
3. Click **Search**.

A list of recordings, similar to the figure below, matching the search parameters is displayed.

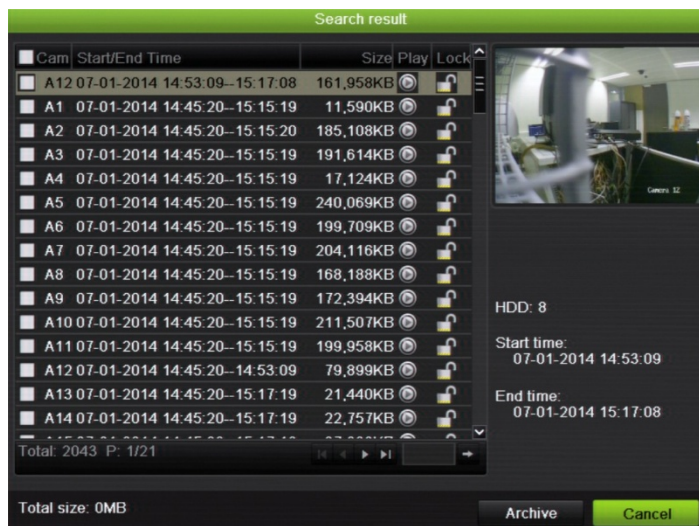

4. Select the file you want to lock/unlock.
5. Click  to lock a file. Click again to unlock.

The Locked column indicates whether a file is locked or not. Closed lock icons indicate locked files while opened lock icons indicate unlocked files. The Lock button toggles between Lock and Unlock, depending on the file.

6. Click **Cancel** to return to live view.

Setting the HDD to read-only

When you set an HDD to *read-only*, recorded video files cannot be written to the HDD. If multiple HDDs are used, the DVR automatically records to the next HDD not set to *read-only*

To set an HDD to read-only:

1. From the menu toolbar, click **System Setting > Hard Disk**.
2. Select the HDD you want to set to read-only.
3. Check **Read only**.
4. Click **Apply** to save the settings. The HDD is now read-only.

Note: In order to enable recordings on that particular HDD again, you must set the HDD status back to R/W (Read/ Write).

HDD redundancy

Setting up HDD redundancy lets your DVR redundantly record a copy of the videos onto multiple drives as a safeguard against losing all your files in case of disk failures. This process is also known as *mirroring*. You must have more than one HDD in your DVR to set up HDD redundancy.

Redundancy significantly reduces the storage capability of the HDDs. As a result you need to double your capacity to record video over a given time.

Note: You must set the storage mode of the HDD to Group before configuring the redundancy. See “Setting up HDD groups” on page 122 for more information.

To set up HDD redundancy:

1. From the menu toolbar, click **System Setting > Hard Disk > HDD Information**.
2. Select the HDD to be used for redundancy and click **Edit**.

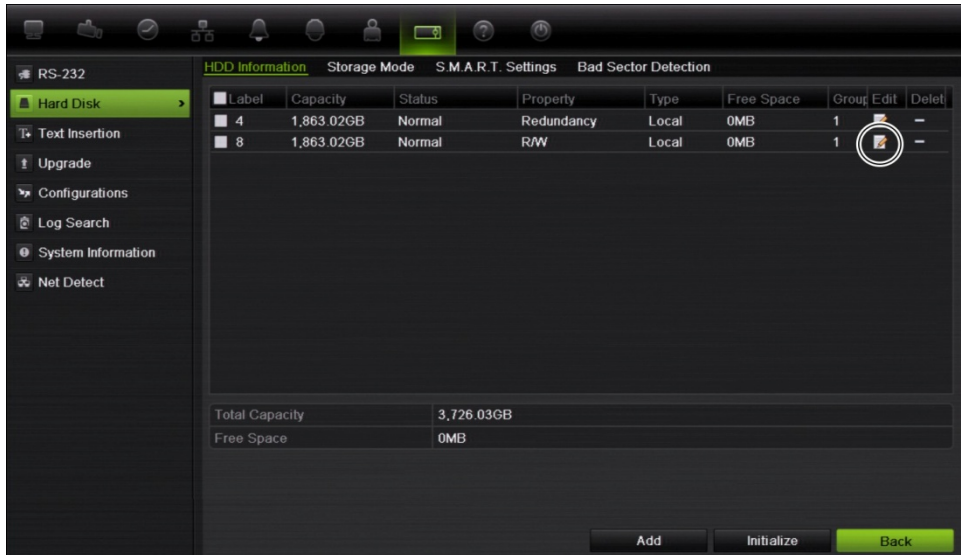

3. In the Local HDD Settings window, select **Redundancy**.
Verify at least one other HDD is set to R/W (read/write).
4. Click **Apply** to save the settings and then **OK** return to the previous window.
5. In the menu toolbar, click the **Video Schedule > Encoding**.
6. Select the camera to be used for redundancy.
7. Check **Redundant Record/Capture**.
8. Click **Apply** to save the settings.
9. Repeat steps 7 to 9 for other cameras whose files you would like to be redundantly recorded.
10. Click **Back** to return to live view.

Chapter 11

Alarm settings

This chapter describes setting up how the system will respond when an alarm is triggered.

Description of alarm notification types

When setting up the rules for alarm detection, you can specify how you want the DVR to notify you about an alarm or event. You can select more than one notification type. Not all notifications types are available for all types of alarms.

Figure 36: Alarm notification types

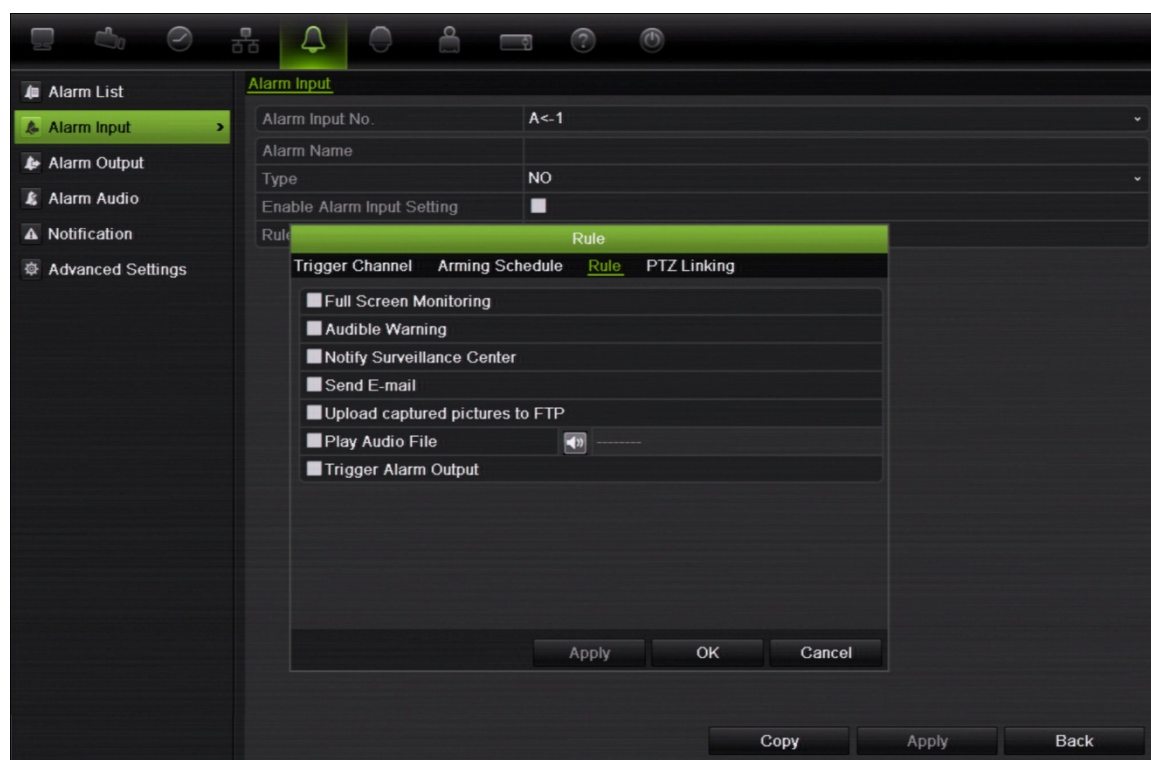

The alarm notification types are:

- **Full Screen Monitoring:** When an alarm is triggered, the local spot monitor (VGA or BNC monitor) displays an image in live view mode. For alarms that

are triggered simultaneously, images display one at a time every 10 seconds (default dwell time). You can set a different dwell time using the Dwell Time setting under the Display Settings>Layout window. When the alarm stops, cycling of the images stops and you return to live view mode. This alarm option must be selected for each channel where it is required.

- **Audible Warning:** Triggers a warning buzzer when an event or alarm is detected by the system or a camera. See “Modifying the warning buzzer” on page 103 for more information.
- **Notify Surveillance Center:** Sends a signal to TruVision Navigator or other software applications when an alarm or notification is detected.
- **Send E-mail:** Sends an e-mail when an alarm or notification is detected. The e-mail includes an HTML link. Click the link to play the video file showing the alarm or notification. See “Configuring e-mail” on page 114 for information on how to configure the DVR to send an e-mail.
- **Upload Captured Pictures to FTP:** Sends snapshots to a designated FTP site. See “Configuring an FTP server” on page 116 for more information.
- **Play Audio File:** Plays a pre-recorded audio message when an alarm or event is triggered. See “Alarm audio messages” below for more information.
- **Trigger Alarm Output:** Triggers an alarm output or multiple alarm outputs when a notification is detected for an external alarm. See “Setting up external alarms” on page 106 for information on configuring an alarm output.

This alarm notification is not available for system alarms.

Alarm audio messages

You can record customized audio messages and upload them onto the DVR to be played back when an alarm is triggered. Up to 5 audio files can be stored on the DVR. The message can be up to 20 seconds long and up to 60 kb in file size. Preferred audio file types are MP3 and WAV.

The administrator uploads the audio files onto the DVR using a web browser or an application supported by the SDK. There are sample audio files provided in English:

- An alarm has been triggered. Please leave the premises immediately.
- An alarm has been triggered. The police have been notified.
- These premises are monitored by video surveillance.
- You have entered a restricted area. Please exit this area immediately.

You can use the Player application to convert an MP3 audio to the audio format supported by TVR41. Once converted, you can then upload the file via the browser.

To import an alarm audio file:

1. Insert the storage device with the alarm audio file in the DVR.
2. From the menu toolbar, click **Alarm > Alarm Audio**.



Note: To modify the name of an audio file, click **Edit** for the desired file and enter the new file name.

3. Click **Import** to import a file. The following window appears:



4. Under **Device Name**, select the storage device.
5. Under **Import to**, select the audio file number, and then click **Import** to return to the Alarm Audio window.
6. Click the **Audio Output** tab and select the desired audio output: HDMI, Audio output1 or Audio output2.
7. Click **Import**.

Note: Up to 5 audio files can be imported.

To delete an alarm audio file:

1. Click the **Alarm** icon in the menu toolbar, and select **Alarm Audio**.
2. Select the file to be deleted, and click **Delete**.

Note: There will always be a minimum of five audio files listed.

Modifying the warning buzzer

When an alarm is triggered by the system or a camera, the DVR can be set up to respond with a warning buzzer. You can modify the time during which the warning buzzer sounds for both system and camera alarm. Select **Alarm > Advanced Settings** and select a buzzer time limit for the system and camera alarms. Default is mute.

Setting up motion detection

Motion detection is one of the most important features of a DVR. With it there is no need to manually search through hours of video recordings to find an event. The TVR 42 can be set up to trigger an alarm if it detects motion and to record it. You can then search these recorded motion activities for specific incidents. If enabled, motion detection recording can help increase the number of days your DVR can record.

You can mask out any areas of motion on a camera display that you do not want to trigger a recording such as a flag on a pole or a moving tree.

Select the level of sensitivity to motion as well the target size so that only objects that could be of interest can trigger a motion recording. For example, recording is triggered by the movement of a person but not that of a cat.

You can set up both the schedule and areas sensitive to motion detection for each camera individually or easily copy the settings of one camera to other cameras. You can also select a specific audio alarm file to play for a camera or group of cameras.

Note: Motion detection cannot be set up from the front panel.

Motion detection set up

To set up motion detection:

1. From the menu toolbar, click **Camera Management > Motion**.

Areas covered by the red grid are sensitive to motion detection.

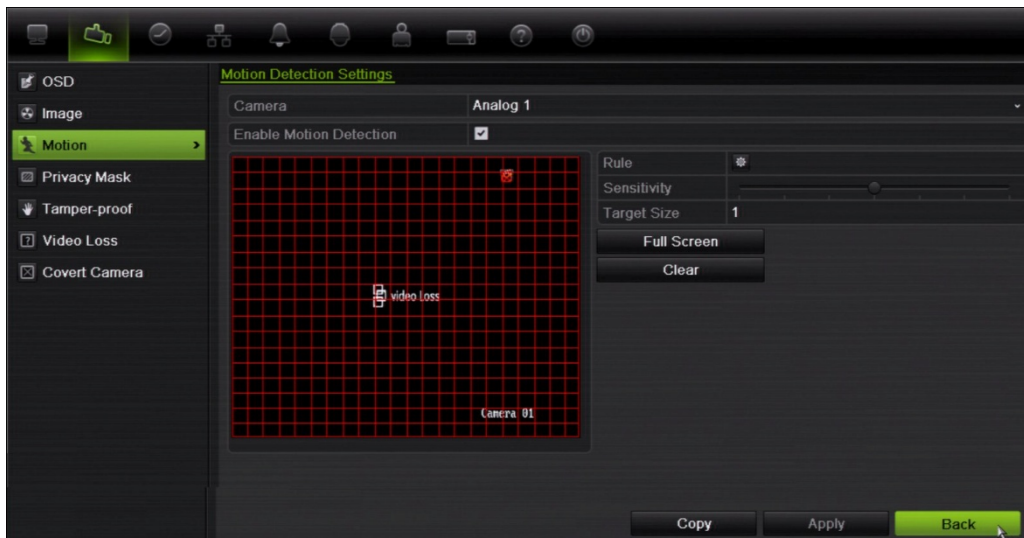

2. Select the camera to detect motion. Each camera must be set up individually.
3. Check **Enable Motion Detection**.
4. Select the areas sensitive to motion.

Click and drag the mouse cursor across the window. The area selected appears as a red grid. Areas covered by the red grid are sensitive to motion detection.

Click **Full screen** to activate the whole window or **Clear** to clear the window.

Note: The motion grid is sensitive to motion during configuration. The grid blocks become red when motion is detected. This real time feedback is available in the OSD, browser, and via the SDK.

5. Set the sensitivity level.

Drag the Sensitivity scroll bar to the desired sensitivity level. The highest value is on the right of the bar.

6. Specify the target size.

In the Target size option, specify how many grid squares must be activated before motion is detected. Enter a value between 0 and 255 squares.

7. Select the cameras that will record the motion detected.

Click **Rule**. The Rule window appears. Click the **Trigger Channel** tab and select the cameras that will record when a motion alarm is triggered. Click **Apply** to save the settings.

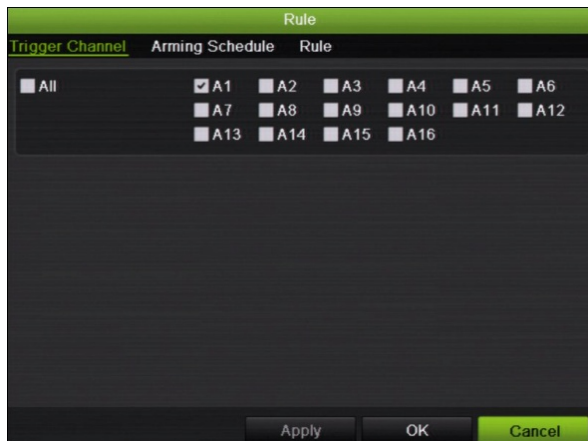

8. Select the recording schedules for motion detection.

Click the **Arming schedule** tab and select the day of the week and the time periods during the day when motion can be recorded. You can schedule up to eight time periods in a day. Default is 24 hours.

Click **Apply** to save the settings. Click **Copy** to copy the settings to other days of the week.

Note: Time periods defined cannot overlap.

9. Select the response method to motion detection.

Click the **Rule** tab to define the method by which you want the DVR to notify you of the alarm. More than one notification type can be selected.



If you want one of the pre-recorded audio messages to play when an alarm or event is triggered, check **Play audio file** and select the desired audio file from the drop-down list. Click the siren button to confirm that you have selected the correct audio file.

Click **Apply** to save settings.

10. Click **OK** to return to the motion detection settings window.
11. Click **Back** to return to live view.

To trigger the front panel alarm LED:

1. Click the **Display Settings** icon in the menu toolbar and select **Monitor>More Settings**.
2. Check both the **Other Notification: Panel Alarm LED** and **Motion Alarm** boxes.

Setting up external alarms

The DVR can be configured to record when an alarm is triggered by an external alarm device (for example, PIR detector, dry contacts...).

To set up external alarms:

1. From the menu toolbar, click **Alarm Settings > Alarm Input**.

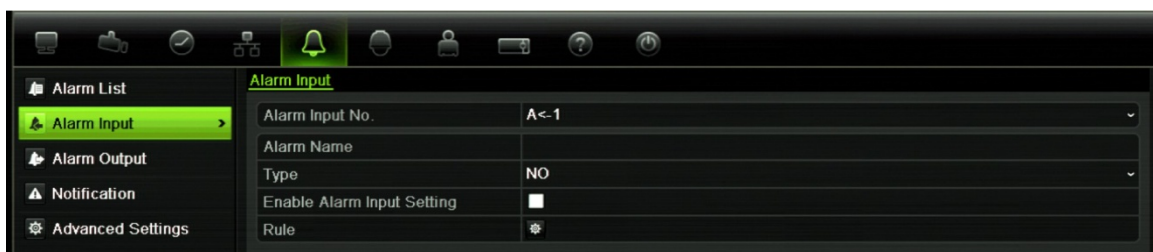

2. Select the alarm input number of a camera, and enter the input name, if required.
3. Select the alarm input type, NO or NC.
4. Check the **Enable Alarm Input** box to enable the function. Click **Rule** to set up the rules for the cameras to be triggered, their alarm schedules, method of alarm notification and PTZ function.
5. Select the cameras to be triggered when an external alarm is detected.

In the Rule window, click **Trigger channel** and select the cameras to be triggered for recording when an alarm is detected. Only analog cameras can be selected. Click **Apply** to save the settings.

6. Select the recording schedules for the external alarm.

Click the **Arming schedule** tab and select the day of the week and the time periods during the day when motion can be recorded. You can schedule up to eight time periods in a day. Default is 24 hours.

Click **Apply** to save the settings. Click **Copy** to copy the settings to other days of the week and holiday period.

Note: The time periods defined cannot overlap.

7. Select the response method to an external alarm.

Click the **Rule** tab to define the method by which you want the DVR to notify you of the alarm. Click **Apply** to save settings.



8. Select the PTZ camera function required in response to an external alarm. Click the PTZ Linking tab and select the PTZ camera as well as the preset, preset tour or shadow tour that is triggered when the alarm is detected.

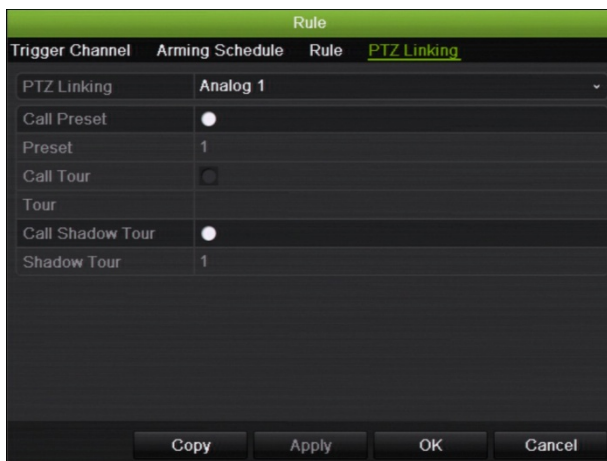

Click **Apply** to save the settings. Click **Copy** to copy the settings to other cameras, if required.

9. Click **OK** to return to the alarm input window.
10. Click **Back** to return to live view.

To set up an alarm output:

1. From the menu toolbar, click **Alarm Settings > Alarm Output**.
2. Select the alarm output.
3. Select a timeout option.

The timeout setting lets you define how long a signal remains active after the alarm has ended. If you select **Manually Clear**, the signal remains active until it is manually acknowledged by pressing the alarm button on the front panel or remote control (see “Triggering or clearing alarm outputs manually” on page 108).

4. Select the recording schedules for the alarm output.

Click **Rule** and select the day of the week and the time periods during the day when motion can be recorded. You can schedule up to eight time periods in a day. Default is 24 hours.

Click **Apply** to save the settings. Click **Copy** to copy the settings to other days of the week and holiday period.

Note: The time periods defined cannot overlap.

5. Click **OK** to return to the alarm output window.
6. Click **Back** to return to live view.

Triggering or clearing alarm outputs manually

When an alarm is activated, the DVR can be set up so that the alarm must be manually acknowledged in order to be silenced. See “Setting up external alarms” on page 106 for information on setting up an alarm to be manually cleared.

All user levels (administrator, manager and operator) can manually acknowledge an alarm.

To trigger or clear alarm outputs manually:

1. From the menu toolbar, click **Alarm Settings > Alarm Output**.
2. Click the **Manual Alarm** tab.
3. Select the desired alarm output and click one of the following buttons:
 - **Clear:** Clear to stop alarm output.
 - **Trigger All:** Trigger all alarm outputs at once. This action could be done, for example, when you need to test them.
 - **Clear All:** Stop all alarm outputs at once.
4. Click **Back** to return to live view. The alarm is silenced.

- Or -

1. Press the **Alarm** button on the front panel or remote control. The alarm is silenced.

Setting up system notifications

Setting up system notifications instructs the DVR to alert you when irregular events occur and how to alert you to the event.

You can quickly check the system status by looking at the status LEDs on the front panel. When there is an irregular event with the system, an icon appears on window to also alert you. See “Status information” on page 33 for further information.

The system notifications include:

- **HDD Full:** An installed HDD is full (Overwrite option is disabled).
- **HDD Error:** Errors occurred while files were being written to the HDD, no HDD installed or HDD had failed to initialize.
- **Network Disconnected:** Disconnected network cable.
- **IP Conflicted:** Conflict in IP address setting.
- **Illegal Login:** Wrong user ID or password used.
- **Abnormal Video Signal:** Unstable video signal or video loss detected.
- **Input/output Video Standards Mismatch:** I/O video standards do not match.
- **Abnormal Record:** Recording failed due to encoder or HDD problems.

See “Description of alarm notification types” on page 100 for information on the different alarm notification types available.

To set up system notifications:

1. From the menu toolbar, click **Alarm Settings > Notification**.
2. Select a notification type. See “Description of alarm notification types” on page 100 for more information.
3. Check one or more response options: Full screen monitoring, audible warning, notify surveillance center, send e-mail, upload captured pictures to FTP, play audio file, and trigger alarm output.
4. Click **Apply** to save the settings.

Detecting video loss

Video may be lost if the video cable or camera develop a fault or are damaged. You can set up the DVR to detect video loss and trigger a system notification.

To setup video loss detection:

1. From the menu toolbar, click **Camera Management > Video Loss**.
2. Select a camera to configure for video loss detection.
3. Check the **Enable Video Loss Alarm** box to enable the feature.
4. Click **Rules** next to the Video Loss Detection box to enter the Rules window.
5. Click the **Rule** tab and select how you want the DVR to notify you of video loss. Click **Apply** to save the settings and then click **OK** to return to the previous window.
6. Click the **Arming Schedule** tab and select the schedule of when you want video loss detection to be enabled. Schedule can be set for all week or any day of the week with up to 8 time periods per day.

7. Click the **Apply** button to save settings.
8. Click **Copy** to copy these settings to other cameras.
9. Click **Back** to return to live view.

Detecting video tampering

Video tampering, such as moving a camera to a different position, can also be detected and set to trigger an action on the DVR.

Note: It is strongly recommended not to configure for video tampering when using PTZ dome cameras.

To set up video tampering detection:

1. From the menu toolbar, click **Camera Management > Tamper-Proof** .
2. Select a camera to configure for tamper-proof.
3. Check the **Enable Tamper-proof** box to enable the feature.
4. Define a tampering area.

The tamper detection area setup interface lets you define an area on screen where you want camera tampering to be detected. Click and drag the mouse across an area to mark that area for video tampering. You can only set one tampering area with the full screen being the maximum area. Click **Clear** to clear the window.

5. Select the tamper detection sensitivity level by clicking the sensitivity scroll bar. Higher sensitivity is to the right of the bar.
6. Select the recording schedules for the tamper.

Click **Rule** and then select the **Arming schedule** tab to select the day of the week and the time periods during which tamper can be detected. You can schedule up to eight time periods in a day. Default is 24 hours.

Click **Apply** to save the settings. Click **Copy** to copy the settings to other days of the week and holiday period.

Note: The time periods defined cannot overlap.

7. Select the response method to an external alarm.

Click **Rule** and then select the **Rule** tab to select the method by which you want the DVR to notify you of the alarm. Click **Apply** to save settings and then **OK** to return to the previous window.

8. Click **Back** to return to live view.

Chapter 12

Network settings

You must configure your DVR's network settings before using it over the network.

Note: As every network configuration may differ, please contact your Network Administrator or ISP to see if your DVR requires specific IP addresses or port numbers.

Configuring general network settings

To configure general network settings:

1. From the menu toolbar, click **Network Settings > General** .



2. Enter the required settings:

Option	Description
NIC type	Network interface card (NIC) is a device used to connect the DVR to a network. Select the NIC type used from the drop-down list. Default value is 10/100/1000M self-adaptive.

Option	Description
Enable DHCP	Check this box if you have a DHCP server running and want your DVR to automatically obtain an IP address and other network settings from that server. Default value is Disable.
IPv4 address	Enter the IP address for the DVR. Default value is 192.168.1.82.
IPv4 subnet mask	Enter the subnet mask for your network so the DVR will be recognized within the network. Default value is 255.255.255.0
IPv4 default gateway	Enter the IP address of your network gateway so the DVR will be recognized within the network. This is typically the IP address of your router. Default value is 192.168.1.1
IPv6 address 1	Enter the IPv6 address for the DVR. Default value is: fe80::8ee7:48ff:fe22:b80b/64.
IPv6 address 2	Enter the IPv6 address for the DVR.
IPv6 default gateway	Enter the IPv6 address of your network gateway so the DVR will be recognized within the network. This is typically the IP address of your router.
MAC address	Enter the MAC address.
MTU (bytes)	Enter a value between 500 and 1500. Default is 1500.
Preferred DNS server	Enter the preferred domain name server to use with the DVR.
Alternate DNS server	Enter the alternate domain name server to use with the DVR.

3. Click **Apply** to save the settings.
4. Click **Back** to return to live view or to continue to configure.

Configuring PPPoE

You can connect the DVR directly to a DSL modem. To do this, you need to select the PPPoE option in the network settings. Contact your ISP to get the user name and password.

To configure general network settings:

1. Click the **Network settings** icon in the menu toolbar to display its window.
2. Click **PPPoE** and check the enable PPPoE box.
3. Enter your user name and password, and confirm the password.
4. Click **Apply** to save the settings.

Configuring DDNS

A static IP address never changes so you can enter it into the browser or CMS and the DVR network connection will always work with it.

However, if you have a dynamic IP address for your public IP address, it will change every time you connect to the network. Under such situations, you can set up a dynamic domain name system (DDNS) that will link your public IP address to a host name so that you can connect to the DVR with the host name.

Note: If you are not seeing video over your cellular network, some cellular providers block port 554 so you may need to change it to another value. See Appendix C “Port forwarding information” on page 146 for more information.

There are two ways to set up a DDNS:

- **DynDNS:** Manually create your own host name. You will first need to create a user account using the hosting web site, DynDDNS.org.
- **ezDDNS:** Activate the DDNS auto-detection function to set up a dynamic IP address. The server is set up to assign an available host name to your DVR.

Figure 37: ezDDNS setup window



To set up DDNS:

1. From the menu toolbar, click **Network Settings > DDNS**.
2. Check the **Enable DDNS** box to enable this feature.
3. From **DDNS type**, select one of the DDNS types listed:
 - **ezDDNS:** Click the **Get URL** button. The URL address to access the unit is displayed. If no host name is specified, the DDNS will allocate one automatically.

The maximum length for the host name field is 63 characters. This limit does not include *tvn-ddns.net*. An example of a host name could be *max63chars.tvr-ddns.net*.

- **DynDNS:** Enter the server address for DynDNS (i.e. members.dyndns.org). In the DVR domain name field, enter the domain obtained from the DynDNS web site. Then enter the user name and password registered in the DynDNS network.
4. Click **Apply** to save the settings.
 5. Click **Back** to return to live view or to continue to configure.

Configuring an NTP server

A Network Time Protocol (NTP) server can also be configured on your DVR to keep the date and time current and accurate.

Note: If the device is connected to a public network, you should use a NTP server that has a time synchronization function, such as the server at the National Time Center (IP Address: 210.72.145.44) or europe.ntp.pool.org. If the device is setup in a more customized network, NTP software can be used to establish a NTP server used for time synchronization

To set up an NTP server:

1. From the menu toolbar, click **Network Settings > NTP**.
2. Check the NTP box to enable feature. It is enabled by default.
3. Enter the NTP settings:
 - **Interval:** Time in minutes to synchronize with the NTP server. The value can be between 1 and 10080 minutes. Default is 60 minutes.
 - **NTP server:** IP address of the NTP server.
 - **NTP port:** Port of the NTP server.
4. Click **Apply** to save the settings.
5. Click **Back** to return to live view or to continue to configure.

Configuring e-mail

Your DVR can send e-mail notifications of alarms or notifications through the network. The e-mail includes an HTML link. Click the link to play the video file showing the alarm or notification.

Note: Ensure that the DNS address has been set up correctly beforehand.

To configure e-mail settings:

1. From the menu toolbar, click **Network Settings > E-mail**.
2. Enter the required settings.

Option	Description
Enable server authentication	Check the box if your mail server requires authentication, and enter the login user name and password.
SMTP server	Enter the SMTP server's IP address.
SMTP port	Enter the SMTP port. The default TCP/IP port for SMTP is 25.
Enable SSL	Check the box to enable SSL if it is required by the SMTP server. This feature is optional.
Sender	Enter the name of the sender of the e-mail.
Sender's address	Enter the sender's e-mail address.
Select receivers	Select an e-mail recipient. Up to three receivers can be selected.
Receiver	Enter the name of the receiver of the e-mail.
Receiver's address	Enter the e-mail address of the receiver.
Enable attached snapshot	Check the Attach JPEG File box if you want to send an e-mail with attached alarm images.
Interval	Select an interval range in the Interval box. The interval range represents the time range in between the alarm images being sent. For example, if you set the interval range at two seconds, the second alarm image will be sent two seconds after the first alarm image

3. Click **Test** to the test e-mail settings.

Note: We recommend that you test the e-mail settings after entering values in the e-mail window.

4. Click **Apply** to save the settings.
5. Click **Back** to return to live view or to continue to configure.

Configuring UPnP

The DVR supports UPnP (Universal Plug and Play). This feature lets the DVR automatically configure its own port forwarding, if this feature is also enabled in the router.

You can select one of two methods to set up UPnP:

Automatic mapped type: The DVR automatically uses the free ports available that were set up in the Network Settings menu.

Manual mapped type: You enter the particular external port settings and IP addresses required to connect to the desired router (see Figure 38 **Error! Bookmark not defined.**).

To enable UPnP:

1. Connect the DVR to the router.

Note: The router must support UPnP and this option must be enabled.

2. From the menu toolbar, click **Network Settings > UPnP**.



3. Enable the UPnP option.
4. From **Mapped Type**, select Auto or Manual.
If Manual is selected, enter the external ports and IP addresses required.
5. Click **Apply**.

Configuring SNMP

SNMP is a protocol for managing devices on networks. When you enable SNMP in the menu, network management systems can retrieve DVR status information from the DVR via SNMP.

When you set the trap address and trap port in the DVR menu to the network management system's IP address and port number and setup the network management system as trap receiver, trap notifications (such as startup) will be sent from the DVR to the network management system.

Before using this function, you must first install the SNMP software

To configure SNMP protocol settings:

1. From the menu toolbar, click **Network Settings > SNMP**.
2. Enter the required settings.
3. Click **Apply** to save the settings.

Configuring an FTP server to store snapshots

You can upload your snapshots to an FTP server for storage.

Note: It is not possible to stream video to an FTP site.

To configure the FTP server settings:

1. From the menu toolbar, click **Network Settings > FTP**.
2. Check the **Enable FTP** box.
3. Enter the FTP server information.
4. Select the desired directory. The root directory is default.
5. Click **Apply**.

Configuring a remote alarm host

If a remote alarm host set, the DVR sends a signal to the host when an alarm is triggered. The remote alarm host must have the TruVision Navigator server software installed.

To set up a remote alarm host:

1. From the menu toolbar, click **Network Settings > More Settings**.
2. Enter Alarm Host IP and Alarm Host Port.

Alarm host IP represents the IP of the remote PC where the Network Video Surveillance software installed. The alarm host port value must be the same as software's alarm monitor port. Default port is 7200.

Configuring multicast

Setting up multicasting resolves limitation issues when streaming videos through a network access device. A multicast address spans the Class-D IP range of 224.0.0.0 to 239.255.255.255. We recommend that the IP address range of 239.252.0.0 to 239.255.255.255 be used.

To set up multicasting:

1. From the menu toolbar, click **Network Settings > More Settings**.
2. Enter a Multicast IP address.

Note: When adding a device to the Network Video Surveillance software, the multicast address must be the same as the DVR's multicast IP.

3. Click **Apply** to save the settings.

Configuring the server and HTTP ports

You can change the server and HTTP ports from the default settings in the Network Settings window. The default server port is 8000 while that of the default HTTP port is 80.

Note: The server port has a port range of 2000 to 65535 and is used for remote client software access. The HTTP port is used for remote internet browser access.

To change the default ports:

1. From the menu toolbar, click **Network Settings > More Settings**.
2. Enter the new Server Port and HTTP Port values.

Configuring the RTSP service port

The RTSP (Real Time Streaming Protocol) is a network control protocol designed for use in entertainment and communications systems to control streaming media servers.

To configure RTSP service port:

1. From the menu toolbar, click **Network Settings > More Settings**.
2. Enter the RTSP port value. The default value 554.
3. Click **Apply** to save the settings.

Checking network status

You can easily check network traffic in order to obtain information about the DVR such as its linking status, MTU, sending/receiving rate, MAC address, and NIC type. You can save then this information to a storage device.

You can also check the network connection status by testing its delay and packet loss.

To check network traffic:

1. From the menu toolbar, click **System Settings > Net Detect > Traffic**. The Traffic window appears. The information displayed is refreshed once a second.



To check network delay and packet loss:

1. From the menu toolbar, click **Network Settings > Net Detect > Network Detection**.
2. Under the section “Network delay, Packet loss test”, enter the destination address and click **Test**.

The test result appears in a pop-up screen.

3. If you need to check the current network parameters, click the **Network** button to get an overview.

To check network statistics:

1. From the menu toolbar, click **System Settings > Net Detect > Network Stat**.
2. The latest information is displayed on the bandwidth used by remote live and playback as well by Net Receive Idle and Net Send Idle. Click **Refresh** to update the information.

Exporting network packet data

When the DVR is connected to a network, you can export the captured data packet to a, USB-flash disk, SATA/eSATA CD-RW and other local backup devices.

To export network packet data:

1. From the menu toolbar, click **System Settings > Net Detect > Network Detection**.
2. Under the section “Network packet export”, click **Refresh** to get a list of the local backup devices available. Select one from the list.

3. Click **Export**. Up to 1M of data can be exported at a time.

Bandwidth throttle management

The Bandwidth Throttle Management function lets you throttle the amount of network data sent from the DVR to a client. This function is helpful for networks that have predefined bandwidth limits. This feature lets you control the DVR in a network-sensitive environment and prohibits the DVR from sending a large amount of network data that can potentially disrupt the network.

Both live dual streaming and bandwidth throttle management can be used simultaneously or individually. For example, if you display live video in the web browser with the bandwidth throttle management feature enabled, the video update rate is lower, as network video data is sent in shorter, controlled amounts. However, if live dual streaming is enabled, then the video quality increases, since the second stream can be reduced to meet the bandwidth throttle settings, which results in a higher video update rate.

Only the administrator can modify this function.

To modify the network throttle:

1. From the menu toolbar, click **System Settings > Net Detect > Network Stat**.

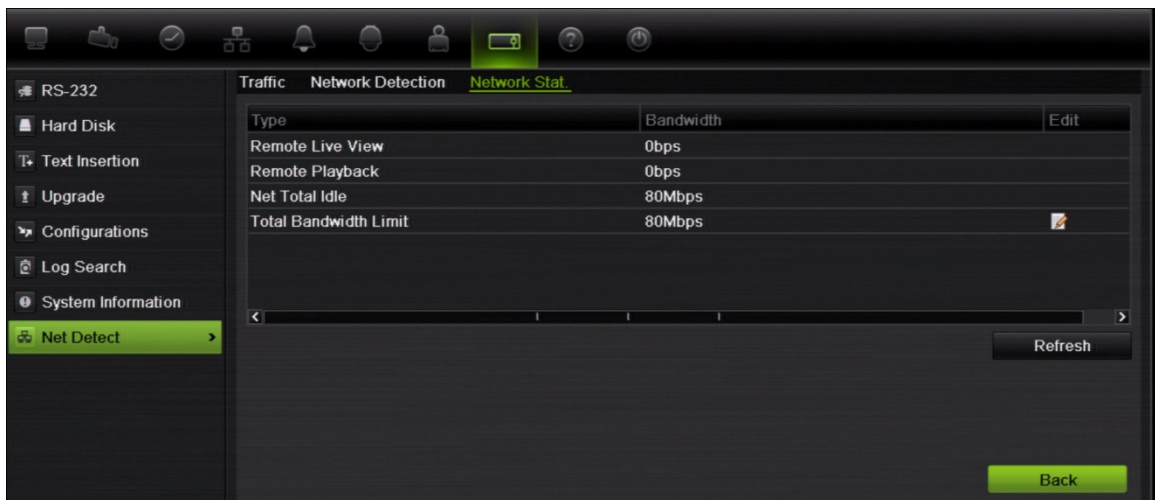

2. Under **Net Bandwidth Limit**, enter a bandwidth limit value. The value can be between 128 Kbps and 80 Mbps, in 1 Kbps increments.
3. Click **Refresh**.

Chapter 13

HDD management

Initializing HDDs

The in-built HDD must be initialized before it can be used. You can also re-initialize the HDD. However, all data on the HDD will be destroyed.

To initialize an HDD:

1. From the menu toolbar, click **System Settings > Hard Disk**.
2. Under the HDD Information tab, select the HDD to be initialized.

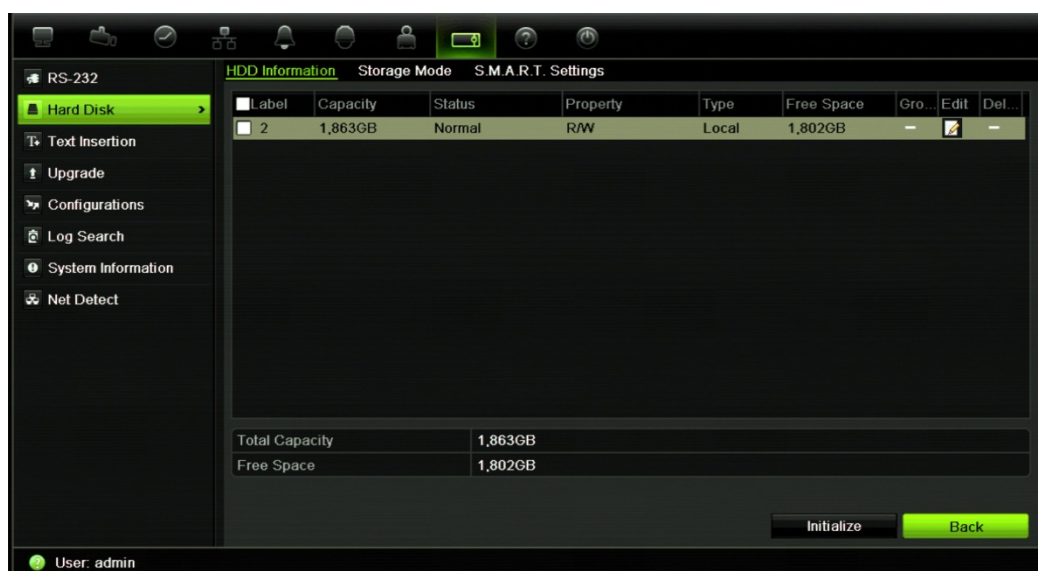

3. Click the **Initialize** button to begin initialization.

After the HDD has been initialized, the status of the HDD changes from Abnormal to Normal.

Controlling disk space on the HDD

You can allocate the maximum permitted storage and snapshot picture capacities from each camera on an HDD.

1. Click the **System Settings** icon in the menu toolbar and select **Hard Disk**.
2. Click the **Storage mode** tab.
3. Under the Mode option, select **Quota**.
4. Select a camera whose storage capacity you want to change and enter the values in GB for maximum record capacity and maximum picture capacity. The maximum storage capacity of the HDD is listed.
5. Click **Apply** to save the settings.
6. If you want to copy these values to other cameras, click **Copy** and select the cameras. Click **OK**. Click **Apply** to save the settings.

Setting up HDD groups

Your DVR can organize multiple HDDs into groups. Videos from specified channels can be set to be recorded onto a particular HDD group. You could, for example, save the records from a couple of high priority cameras to one HDD, and save the recordings from all the other cameras to another HDD.

To set up an HDD group:

1. From the menu toolbar, click **System Settings > Hard Disk**.
2. Select the **Storage Mode** tab.
3. Under **Mode**, select **Group**.

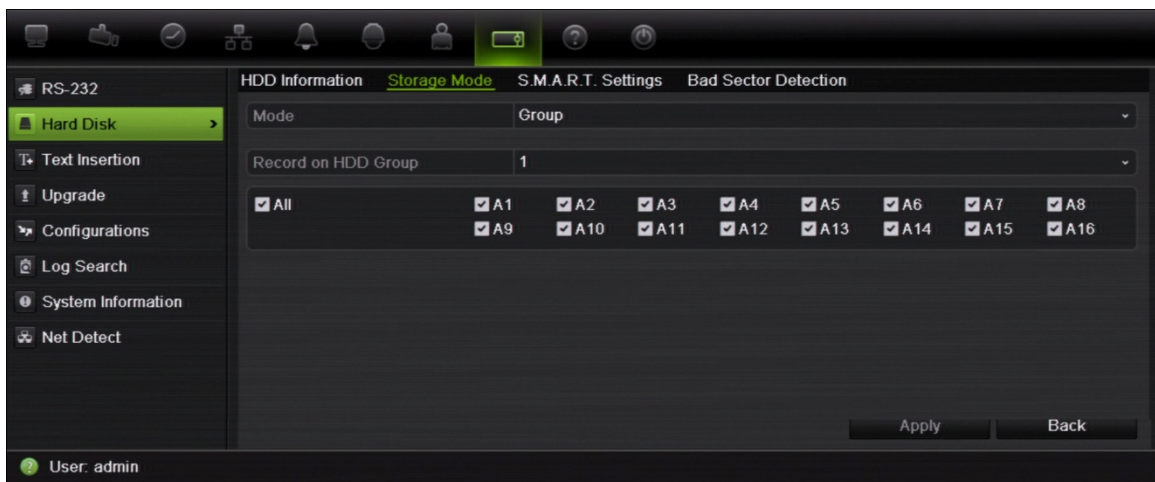

4. Under **Record on HDD Group**, select the HDD group number.
5. Check the channels to be added to this group.
Note: By default, all channels belong to HDD Group 1.
6. Click **Apply** to save the settings.

Recording dual streaming

Dual streaming allows high quality video to be recorded in one stream (main stream) and lower quality video to be recorded in another stream (substream) that can be easily streamed through a narrow bandwidth.

The normal stream has the frame rate, quality, and resolution as configured in the encoding menu. However, in a thin stream data thinning has been carried out so that it has a lower quality and storage requirements. This allows more video to be recorded on the HDD.

To record dual streaming:

1. From the menu toolbar, click **System Settings > Hard Disk**.
2. Select the **Storage Mode** tab.
3. Under **Mode**, select **Dual Streaming**.
4. Drag the markers to specify the percentage of the HDD that should be used to store main stream recordings (green), substream recordings (blue), and snapshots (pink).

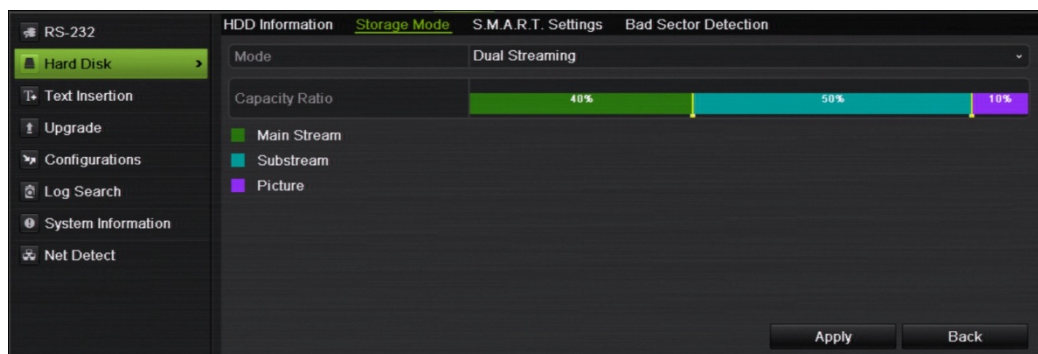

5. Click **Apply** to save the settings.

Setting the HDD property

You can change the behavior of your HDD by changing its property. It can be set to redundancy, read-only, or read/write (R/W).

An HDD can be set to read-only to avoid important recorded files from being overwritten when the HDD becomes full.

Before changing the HDD property to “Redundancy”, there must be at least two HDDs installed in the DVR. You need to set the storage mode to “Group” and one of the other HDDs must be set to R/W. See “Setting up HDD groups” on page 122 for more information.

Note: Ensure that the HDD storage mode is “Group” before setting the HDD to read-only.

To change an HDD status property:

1. From the menu toolbar, click **System Settings > Hard Disk**.
2. Click the **HDD Information** tab.
3. Select the HDD whose property you want to change.
4. Click the **Edit** icon . The Local HDD Settings window appears.
5. Click the desired HDD property for the selected HDD.
6. Click the group number for this HDD.
7. Click **Apply** to save and exit the window.

Note: Once set to read-only, the HDD cannot be used to save recorded files until it is set back to read/write (R/W). If the HDD that is currently being written to is set to read-only, the data is then recorded to the next HDD. If there is only one HDD present, setting it to read-only means the DVR cannot record.

Checking HDD status

You can check the status of any of the installed HDDs on the DVR at anytime.

To check the status of an HDD:

1. From the menu toolbar, click **System Settings > Hard Disk**.
2. Note the status of the HDDs listed under the Status column.

If the status is listed as Normal or Sleeping, the HDD is in working order. If it is listed as Abnormal and has already been initialized, the HDD needs to be replaced. If the HDD is Uninitialized, you need to initialize it before it can be used in the DVR. Refer to “Initializing HDDs” on page 121 for more information.

Note: This information is also available under **System Settings > System Information > HDD** window.

Configuring HDD alarms

HDD alarms can be set to trigger when an HDD is uninitialized or in an abnormal state.

To set HDD alarms:

1. From the menu toolbar, click **Alarm Settings > Notification**.
2. Select the notification event to configure under Notification Type box.
3. Select **HDD Full** and check the desired notification method. See “Description of alarm notification types” on page 100 for more information.

- Select **HDD Error** and check the desired notification method.
4. Click **Apply** to save the settings.

Managing eSATA

If you are using an external e-SATA device connected to the DVR, you can configure the e-SATA to record/capture or export video.

Select the **Export** option when using the eSATA as a backup. See “Using Quick Archive” on page 67 for further information.

Select the **Record/Capture** option to record and capture video. Information on the eSATA for this purpose can be seen under **System settings > Hard Drive > HDD Information**.

To set up the e-SATA device:

1. From the menu toolbar, click **Video Schedule > More Settings**.
2. Under **eSATA**, select the desired option: **Record/Capture** or **Export**.
3. Click **Apply** to save the settings.

Checking the S.M.A.R.T. information

S.M.A.R.T. (Self-Monitoring, Analysis and Reporting Technology) reports on a variety of hard drive attributes. It helps ensure that the HDD is functioning properly at all times while protecting video stored on the hard drive.

To view the S.M.A.R.T. information of an HDD:

1. From the menu toolbar, click **System Settings > Hard Disk**.
2. Select the **S.M.A.R.T. Settings** tab to display its window.
3. Select the HDD whose data you want to see. A detail listing of S.M.A.R.T. information is displayed.

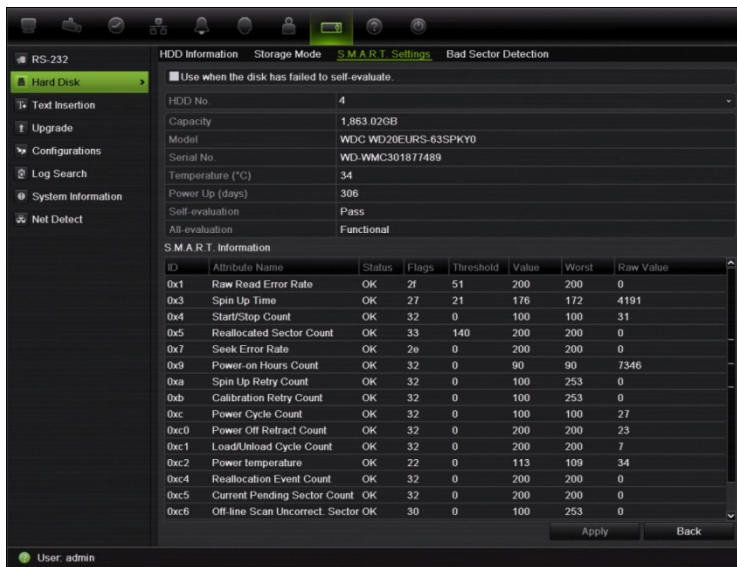

- If you want to continue to use an HDD when the S.M.A.R.T. test has failed, check the box **Use when the disk has failed to self-evaluate**. Click **Apply** to save the settings.

Searching video using disk analysis

The DVR can run a disk analysis to get a broader sense of the video data stored on the HDD. This video data can include alarms, events, video Loss, and more.

The disk analysis window provides a graphical view of the all video stored on the HDD for each camera. The scale is determined dynamically. The timeline flows from left (oldest) to right (newest) video. See Figure 39 on page 127.

Figure 38: Disk analysis window



1. **Zoom level:** This is the zoom level and date displayed.
2. **Time marker:** This is the time of the analysis.
3. **Time window:** This represents the time period of the selected zoom level for all the cameras. Events that occurred during this period are indicated on the time bar for each camera. The type of event recorded is color coded.
4. **Change zoom level:** Click the in or out buttons to zoom the analysis view in and out between five levels. The levels are:
 - Level 1: Year view
 - Level 2: Month view
 - Level 3: Day view
 - Level 4: Six-hour view
 - Level 5: One-hour view
5. **Type of event:** Up to five types of event recordings can be displayed: Constant, motion, alarm, manual, and text insertion. Black is no recording.

To search recorded video using disk analysis

1. In live view, right-click the mouse and in the mouse menu select **Advanced Search > Disk analysis**.
3. Click the **HDD** to analyze and then the **Analyze** button. The disk analysis window appears.
4. Move the time/date marker to the time period of interest. Click the zoom **in** and out buttons to focus in and out on the time period for viewing.

Note: The playback option is not available.

Chapter 14

Camera settings

The TVR 42 can support up to 16 analog cameras.

Configuring the camera OSD settings

The DVR lets you configure which information is displayed on-screen for each camera. The on-screen display (OSD) settings appear in live view mode and include the camera name, time and date. They also are included in recordings.

You can also adjust the transparency of the OSD relative to the background so that it is easier to read or is less prominent on screen.

To configure the OSD settings:

1. From the menu toolbar, click **Camera Management > OSD**.

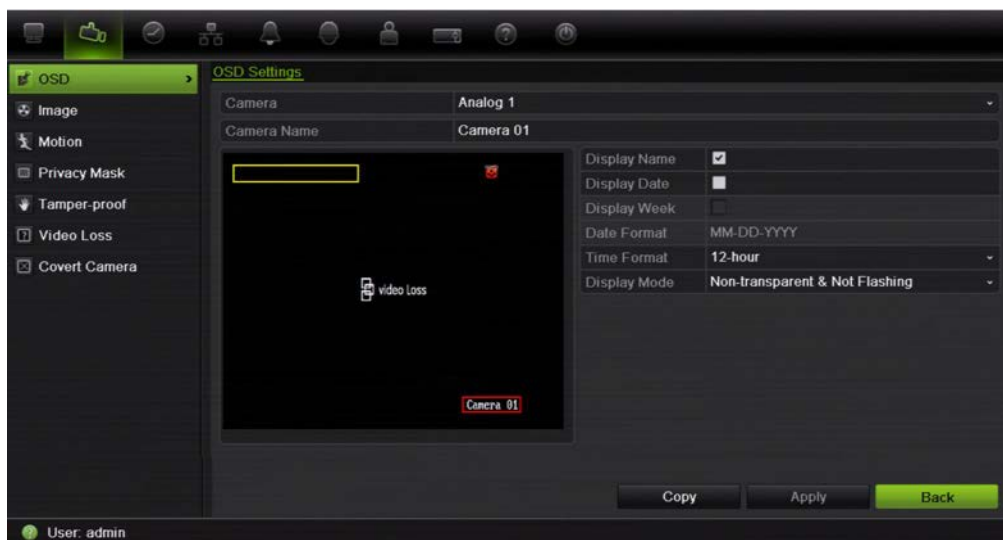

2. Enter a name for the camera, if required.
3. Check the Display Name, Display Date, and Display Week boxes to display the camera name, date, and week.
4. Select a date format and a time format.
5. Select how you want the camera information displayed.

Select one of the options from the drop-down list. Default is non-transparent/non-flashing.

- Transparent & flashing
 - Transparent & not flashing
 - Non-transparent & flashing
 - Non-transparent & non-flashing
6. There are two text boxes in the camera view window; one for the camera name (yellow box) and the other for the date/time (red box). Using the mouse, click and drag a text box to the desired position.
 7. To copy the settings to other cameras, click **Copy** and select the desired cameras. Click **OK**.
 8. Click **Apply** to save the settings and then **Back** to return to live view.

Setting up privacy masking

You can define an area on screen to remain hidden from view. For example, you can choose to block the view of a camera when overlooking residential premises. This hidden area is referred to as privacy masking. Privacy masking cannot be viewed in live view or recorded mode, and appears as a black area on the video image.

To setup a privacy mask:

1. From the menu toolbar, click **Camera Management > Privacy Mask**.
2. Select the camera for which to set up privacy masking.
3. Check the **Enable Privacy Mask** box to enable the feature.
4. Set up the mask area. Up to four areas can be set.

Using the mouse, click and drag a privacy-mask box in the camera view window over the desired area. You can set up to four areas for privacy masking. Masked areas are dimmed and outlined in four different colors. Click **Apply** to save settings.



- To delete a mask, check the desired mask and click **Clear** for that color mask.
5. To copy the settings to other cameras, click **Copy** and select the desired cameras. Click **OK**.
 6. Click **Apply** to save the settings and then click **Back** to return to live view.

Adjusting camera image settings

You may need to adjust the camera image depending on the location background in order to get the best image quality.

The system has four preset mode settings for frequently encountered lighting conditions; Standard, Indoor, Low light and Outdoor. However, you can also manually adjust the brightness, saturation, contrast, and hue values using the Customize option. Adjustments to the settings affect both live view and recorded images.

Note: These options can also be modified from the image settings button on the live view quick access toolbar (see “Accessing frequently used commands” on page 37.)

To adjust display settings:

1. From the menu toolbar, click **Camera Management > Image**.
2. Select the camera for which to adjust the video image settings.
3. Select the desired mode value. Changes are seen immediately on screen.
If “Customize” is selected, adjust the brightness, saturation, contrast, and hue values by dragging each scroll bar.
4. Click **Apply** to save the settings and then click **Back** to return to live view.

Watermarking

You can overlay digital watermarking to authenticate images and protect them from alterations. Watermarking on an image is only visible during playback of exported video.

The DVR supports watermarking from TruVision cameras and encoders.

Use the playback application, Player, to reveal the watermarking on archived video. Enable the Watermarking option in Player.

Hiding a camera image from view

There may be occasions when you want to control who can see a camera image on a local monitor, such as if there is a camera located in a changing room. The

DVR lets you select which camera (or cameras) is not displayed on the local monitor unless the user is logged in and has permission to view the camera images. A covert camera is not displayed on screen when no user is logged in. Instead a person walking by sees a black screen with the Interlogix logo. See Figure 40 below.

Figure 39: Example of a covert camera image



To set up a camera for covert view:

1. From the menu toolbar, click **Camera Management > Covert Camera**.
2. Check which camera or cameras you want to be covert and click **Apply**.

Chapter 15

DVR management

This chapter describes:

- Configuring the RS-232 port
- Updating system firmware
- Restoring default settings
- Viewing system information
- Viewing system logs

Configuring the RS-232 port

Use the System Settings menu to configure the RS-232 parameters such as baud rate, data bit, stop bit, parity, flow control, and usage.

Figure 40: RS-232 setup window



There are three ways the RS-232 port can be used:

- **ProBridge:** POS and ATM text insertion supported via the ProBridge accessory connected to the RS-232 port. See “Capturing text insertions” on page 84 for more information.
- **Challenger:** NTP time sync supported to foreign device over the RS-232 port.
- **Technical support:** Console mode.

Updating system firmware

The firmware on the DVR can be updated using five methods:

- Via an USB device
- Over the network via an FTP server
- Via the DVR web browser
- Using TruVision Navigator. For further information, refer to the TruVision Navigator user manual
- Via an optical drive

The firmware upgrade file is labeled *TVR42.dav*.

To update the system firmware using a USB device:

1. Download on to a USB the latest firmware from our web site at:
www.gesecurityproducts.eu/videoupgrades
- Or -
www.utcssecurityproductspages.eu/videoupgrades
2. Connect the USB device to the DVR.
3. Click the **System Settings** icon in the menu toolbar.
4. Select **Upgrade > Local Upgrade**. The list of files on the USB is displayed.
5. Select the file and click **Upgrade**. Click **Yes** to begin the upgrade process.
6. When the upgrade process is completed, the recorder will reboot automatically.

To update the system firmware via the web browser:

1. Click the **Configuration** tab in the browser toolbar and then select **Maintenance**.
2. For the latest firmware from our web site, download the file at:
<http://www.interlogix.com/library>
- Or -
www.utcssecurityproductspages.eu/videoupgrades
3. Click **Upgrade**.

Note: The upgrade process may take a few minutes. The system will automatically reboot once the upgrade is completed.

To update the system firmware via a FTP server:

For engineering purposes only.

Restoring default settings

To restore the default factory settings of the DVR:

1. From the menu toolbar, click **System Settings > Configuration**.
2. Click the Default button. Enter the Admin password, click **OK**, and then click **Yes** to confirm that you want to restore all parameters to default.

– Or –

Click the **Restore** button. Enter the Admin password, click **OK**, and then click **Yes** to confirm that you want to restore all parameters except network settings to default.

Note: Network information, such as IP address, subnet mask, gateway, MTU, NIC working mode, server port, and default route, is not restored to factory default settings if Restore is selected.

3. The system immediately starts to restore the settings.

Viewing system information

To view system information:

1. Click the **System Settings** icon in the menu toolbar and select **System Information**.
2. To view device information, click the **Device Info** tab.



3. To view camera information, click the **Camera** tab.



4. To view record information, click the **Record** tab.

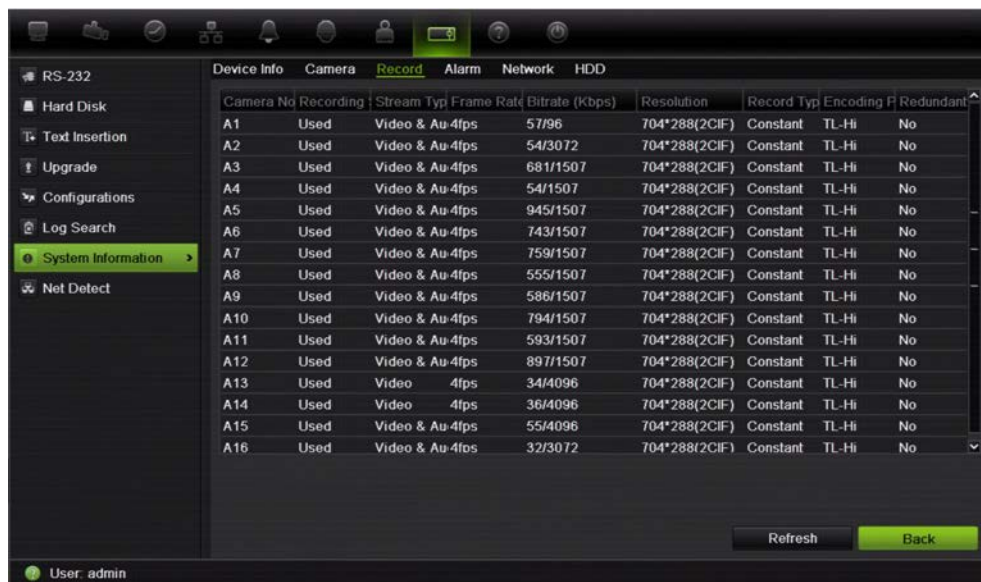

5. To view alarm information, click the **Alarm** tab.

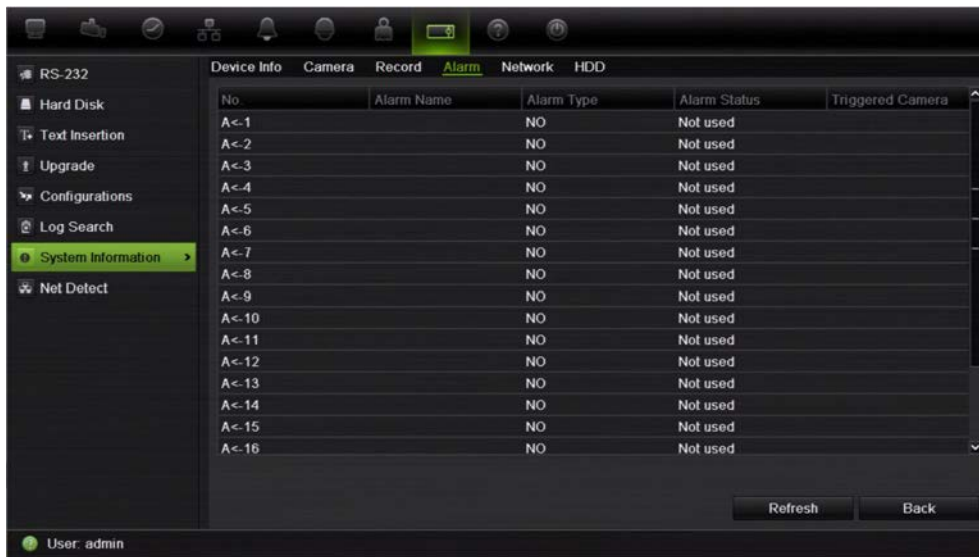

6. To view network information, click the **Network** tab.



7. To view HDD information, click the **HDD** tab.



8. Click **Back** to return to live view.

Searching system logs for events

Many events of the DVR, such as operation, alarm and notification, are logged into the system logs. They can be viewed and exported at any time.

Up to 2000 log files can be viewed at once.

Log files can also be exported onto a USB device. The exported file is named according to the time it was exported. For example: *20130729124841logBack.txt*.

Note: Connect the backup device, such as a USB flash drive, to the DVR before commencing the log search.

To search and export log files:

1. From the menu toolbar, click **System Settings > Log Search**.
2. Enter the search parameters and click **Search** to begin the search. The logs matching the search criteria are displayed.



3. To view more detail information about a particular log entry, select the entry and click or double-click the log entry.
4. If available, you can also view the associated video to the selected log entry by clicking its play button .
5. To export log entries, select the desired logs and click **Export**.
6. Click **Back** to return to live view.

Importing and exporting configuration settings

You can export and import configuration settings from a TVR 42. This is useful if you want to copy the configuration settings to another TVR 42, or if you want to make a back up of the settings.

Insert a USB flash drive in the DVR. Use the **System Settings > Configuration** window to import or export configuration settings. Click **Export Config** to export the DVR's configuration settings into a configuration file. Click **Import Config** to import configuration settings.

Chapter 16

User management

By default the DVR comes with three user accounts: an Administrator account, an Operator account and a Guest account. These accounts provide multiple levels of access and functionality. See Table 18 below for a description of the different user accounts.

Table 17: User accounts

User	Description
Administrator	The administrator account includes extended menu with full access to all settings. The Administrator has the authority to add, delete or configure parameters for many of the system functions. There can only be one administrator. The user name is admin. The name cannot be modified. The default password is 1234.
Operator	The operator account includes reduced menu access to Video settings (inaccessible features are not visible). The default user name is "operator". The default password is 2222.
Guest	The guest account includes menu access with no programming possibilities (inaccessible features are not visible). The default user name is "guest". The default password is 3333.

Note: The default passwords should be changed for security reasons.

Adding a new user

Only a system administrator can create a user. You can add up to 31 new users. The access privileges of Operator and Guest users are predefined and can be modified by the administrator.

To add new users:

1. Click the **User Management** icon in the menu toolbar to display its window.
2. Click **Add** to enter the Add User window.
3. Enter the new user's name and password. Both the user name and password can have up to 16 alphanumeric characters.
4. Select the new user's access level: Operator or Guest.
5. Enter the user's MAC address to let the user access the DVR from a remote computer with this MAC address.
6. Click **Apply** to save the settings and **OK** to return to the previous window.
7. Define the user's permissions.

Click the Permission button  for the new user. In the Permissions pop-up screen check the required access privileges for local, remote and camera configuration. See "Customizing a user's access privileges" below for the permission descriptions for each group.

Click **Apply** to save the settings and **OK** to return to the previous window.

8. Click **Back** to return to live view.

Customizing a user's access privileges

Only an administrator can allocate access privileges to Operator and Guest users. The access privileges can be customized for each user's needs. The administrator's access privileges cannot be changed.

There are three types of privilege settings: Local Configuration, Remote Configuration, and Camera Configuration.

Note: Only the administrator can restore factory default settings and export configuration files.

Local configuration settings:

- **Local Log Search:** Search and view logs on the DVR.
- **Local Parameter Settings:** Configure parameters and import the configuration from the DVR.
- **Local Advanced Operation:** Access HDD management (including the initialization and modification of disk properties). Update system firmware as well as stop the I/O alarm output.
- **Local Shutdown/Reboot:** Shutdown or reboot the DVR.

Remote configuration settings:

- **Remote Log Search:** Remotely view logs that are saved on the DVR.
- **Remote Parameter Settings:** Remotely configure parameters and import/export configuration.
- **Remote Video Output Control:** Remotely enable and disable channels.
- **Remote Serial Port Control:** For future use.
- **Two-Way Audio:** Use two-way radio between the remote client and the DVR.
- **Remote Alarm Control:** Remotely alert or control the relay output of the DVR. Alarm and notification settings must be configured properly to upload to host.
- **Remote Advanced Operation:** Remotely manage HDDs (initializing and setting properties for HDDs) as well as remotely update system firmware, and clear the I/O alarm output.
- **Remote Shutdown/Reboot:** Remotely shutdown or reboot the DVR.
- **V-stream:** Remotely configure v-stream.

Camera configuration settings:

By default, all analog cameras are enabled for operators for each of these settings and none for guests.

- **Local Live View:** Select and view live video locally on the recorder.
- **Local Playback:** Locally play recorded files that are on the DVR.
- **Local Manual Operation:** Locally start/stop manual recording on any of the channels, snapshots and video clips.
- **Local PTZ Control:** Locally control PTZ dome cameras.
- **Local Video Export:** Locally back up recorded files from any of the channels.
- **Remote Live View:** Select and view live video over the network.
- **Remote Playback:** Remotely play and download recorded files that are on the DVR.
- **Remote Manual Operation:** Remotely start/stop manual recording on any of the channels, snapshots and video clips.
- **Remote PTZ Control:** Remotely control PTZ dome cameras.
- **Remote Video Export:** Remotely back up recorded files from any of the channels.

To customize a user's access privileges:

1. Click the **User Management** icon in the menu toolbar to display its window.
2. Click the Permission button  for the user whose access privileges need to be changed. The Permissions pop-up screen appears.

3. Select the desired access privileges from the three tabs: Local Configuration, Remote Configuration, and Camera Configuration.
4. Click **Apply** to save the settings.
5. Click the **OK** button to return to the previous window.
8. Click **Back** to return to live view.

Deleting a user

Only a system administrator can delete a user.

To delete a user from the DVR:

1. Click the **User Management** icon in the menu toolbar to display its window.
2. Click the **Delete** button  for the user to be deleted.
3. Click **Yes** in the pop-up screen to confirm deletion. The user is immediately deleted.
4. Click **Back** to return to live view.

Modifying a user

A user's name, password, access level and MAC address can be changed. Only a system administrator can modify a user.

To modify a user:

1. Click the **User Management** icon in the menu toolbar to display its window.
2. Click the **Edit** button  for the user whose access privileges need to be changed. The Edit User pop-up screen appears.
3. Edit the user information and click **Apply** to save the settings. .
4. Click the **OK** button to return to the previous window.
5. Click **Back** to return to live view.

Changing the Admin password

The administrator's password can be changed in the **User Management** menu. Click the **Change Password** tab and enter the new information. The administrator's MAC address can be changed here too. Once completed, click **Apply** to save the settings.

Appendix A

Specifications

	TVR 4204	TVR 4208	TVR 4216
Video & audio input			
Video compression	H.264		
Analog video input	4-ch, BNC (1.0 Vp-p, 75 Ω), PAL /NTSC self- adaptive	8-ch, BNC (1.0 Vp-p, 75 Ω), PAL /NTSC self- adaptive	16-ch, BNC (1.0 Vp-p, 75 Ω), PAL /NTSC self- adaptive
Audio compression	OggVorbis		
Audio input	4-ch, BNC (2.0 Vp-p, 75 Ω)	8-ch, BNC (2.0 Vp-p, 75 Ω)	16-ch, BNC (2.0 Vp-p, 75 Ω)
Two-way audio	1-ch, BNC (2.0 Vp-p, 1 kΩ)		
Video & audio output			
HDMI output	1-ch, Resolution: 1920 × 1080P / 60 Hz, 1920 × 1080P / 50 Hz, 1600 × 1200 / 60 Hz, 1280 × 1024 / 60 Hz, 1280 × 720 / 60 Hz, 1024 × 768 / 60 Hz		
VGA output	1-ch, Resolution: 1920 × 1080P / 60 Hz, 1600 × 1200 / 60 Hz, 1280 × 1024 / 60 Hz, 1280 × 720 / 60 Hz, 1024 × 768 / 60 Hz		
Analog output	1-ch, BNC (1.0 Vp-p, 75 Ω), Resolution: PAL: 704 × 576; NTSC: 704 × 480		
Video spot output	1-ch, BNC (1.0 Vp-p, 75 Ω), Resolution: PAL: 704 × 576; NTSC: 704 × 480		
Video loop output	4-ch	8-ch	16-ch
Encoding resolution	4CIF / 2CIF / CIF / QCIF / 960h		
Frame rate	25 fps (PAL) / 30 fps (NTSC)		
Video bit rate	32 to 4096 Kbps, or user defined (max. 4096 Kbps)		
Audio output	2-ch, BNC (Linear, 600 Ω)		
Audio bit rate	16 Kbps		

	TVR 4204	TVR 4208	TVR 4216
Dual-stream	Support (Sub-stream at CIF/QCIF: 25 fps (PAL) / 30 fps (NTSC))		
Stream type	Video, Video & Audio		
Playback resolution	4CIF / 2CIF / CIF / QCIF / 960h		
Synchronous playback	4-ch	8-ch	16-ch
Hard disk			
SATA	6 SATA interfaces		
e-SATA	1 e-SATA interface		
Capacity	Up to 2TB capacity for each disk		
External interface			
Network interface	1 RJ45 10M / 100M / 1000M Ethernet interface		
Serial interface	1 RS-232 interface (for ProBridge, Challenger, Technical Support); 1 RS-485 interface (for PTZ control); 1 RS-485 keyboard interface (for KTD405 keyboard control)		
USB interface	2, USB 2.0		
Alarm in	16		
Alarm out	4		
Miscellaneous			
Power supply	100 to 240 VAC, 6.3 A, 50 to 60 Hz		
Power consumption (without HDD or DVD-R/W)	≤ 35 W	≤ 40 W	≤ 45 W
Operating temperature	-10 to +55 °C (14 to 131 °F)		
Relative humidity	10 to 90%		
Chassis	19-inch rack-mounted 2U chassis		
Dimensions (W x H x D)	445 x 470 x 90 mm (17.5 x 18.5 x 3.5 in.)		
Weight	≤ 8 kg (17.6 lb.) (without HDD or DVD-R/W)		

Appendix B

PTZ protocols

Interlogix-485	PHILIPS
Interlogix-422	PHILIPS-3
Kalatel	SAE
DSCP	Samsung
HIKVISION	Siemens
Honeywell	SONY-EVI-D30/31
INFINOVA	SONY-EVI-D70
KTD-348	SONY-EVI-D100/P
LG MULTIX	TECHWIN
LILIN	VICON
PANASONIC_CS850	YOULI
PELCO-D	
PELCO-P	

Appendix C

Port forwarding information

A router is a device that lets you share your internet connection between multiple computers. Most routers will not allow incoming traffic to the device unless you have configured them to forward the necessary ports to that device. By default our software and devices (DVRs and NVRs) require the following ports to be forwarded:

Note: Port forwarding may reduce the security of the computers on your network. Please contact your network administrator or a qualified network technician for further information.

Table 18: Description of the ports

Port	Port name	Description
80	HTTP protocol	Used to connect via IE browser.
8000	Client Software Port	Used to connect to video streams.
554	RTSP Port	Real time streaming protocol. Used to record video remotely.
1024	RTSP Port for 3G/4G	Use with mobile apps. Used for 3G/4G connection.

Note: It is recommended that the RTSP port 1024 should only be used when experiencing connection issues over a 3G/4G connection.

For example: If the client port is changed to 9000 then the +200 port will be 9200. Using the default client port 8000 then the +200 port will be 8200.

Seeking further assistance

Third-party assistance on configuring popular routers can be found at:

<http://www.portforward.com/>

<http://canyouseeme.org/>

<http://yougetsignal.com>

Note: These links are not affiliated with nor supported by Interlogix technical support.

Many router manufacturers also offer guides on their websites as well as including documentation with the product.

On most routers the brand and model number is located on or near the serial number sticker on the bottom of the device.

If you cannot find any information for your particular router, please contact your router manufacturer or internet service provider for further assistance.

Appendix D

KTD-405 keypad

Supported firmware

TVR 42XX-YYY firmware	2.0.d or higher
KTD-405U (-2DU) keypad firmware:	1.4.00

Note: XX represents the number of video channels

YYY represents the DVR storage configuration such as 1T = 1 TB, etc.

Wiring the keypad

Connect the RS-485 bus of the KTD-405 I/O box to the TVR 42 Keypab A/B screw terminal port.

Table 19: Keypad and DVR connections

KTD-405 I/O box	TVR 42 connection
RS-485 A	Keyb A
RS-485 B	Keyb B

Figure 41: Keypad and DVR connections

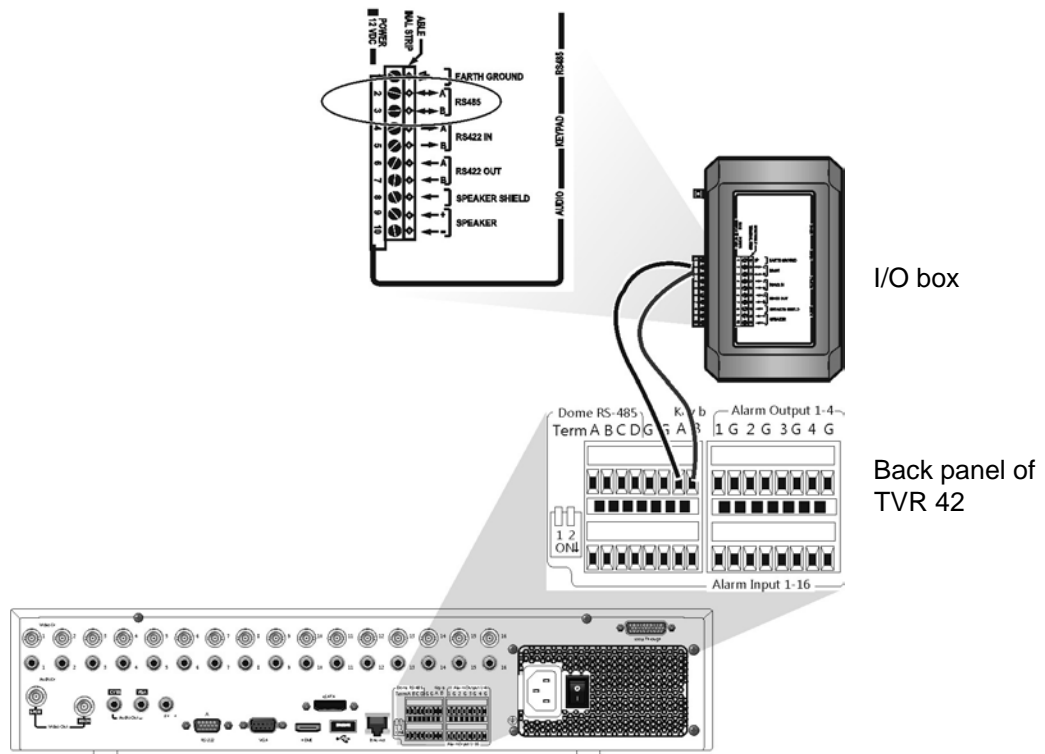

Setting up the keypad to work with the TVR 42

The keypad must be in zone mode to connect correctly with the TVR 42.

Further information on connecting and programming the KTD-405 keypad can be found in the user manual.

To set the keypad in zone mode:

1. Log into the keypad using the Admin password. Hold down the Enter button (↵) until a beep sounds and then enter the following code: **1 4 7 6**. Push the **seq** button to confirm.
2. Scroll through the menus with the **▶** button until this menu appears:

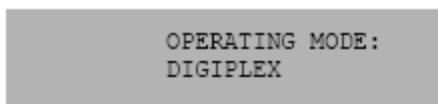

3. Change *Operating Mode* to *Zone* by moving the joystick down.
4. Quit the menu by pressing the **seq** button. The display will show, for example:

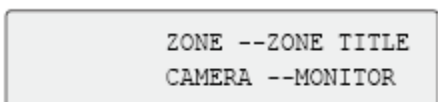

5. To connect it to the DVR, press the **zone** button and enter the ID number of the TVR 42. The default value is “1”.
6. To configure the DVR zone ID number, at the DVR enter the **Monitor** window by selecting **Display Mode Settings** in the main menu, and then select Monitor. Under Zone ID, enter the zone ID value. The default value is “1”.

Note: The zone ID value must be identical for the DVR and keypad.

The TVR 42 is now connected to the KTD-405 keypad.

TVR 42 and keypad functions

The KTD-405U acts as a DVR control keypad when connected to the TVR 42. The keypad mimics many of the functions available from the front panel of the TVR 42.

Unavailable TVR 42 functions

The following TVR 42 functions are unavailable when using the keypad to control the TVR 42:

- Export video
- Shadow tour
- Select motion detection or tampering zones
- Archive records
- Capture video
- Call up presets and set up presets

If these functions are required, it is recommended to use a mouse in conjunction with the keypad as all TVR 42 functions will then be available.

Unavailable keypad functions

The following keypad buttons are unavailable when using the keypad to control the TVR 42:

Figure 42: Unavailable keypad buttons

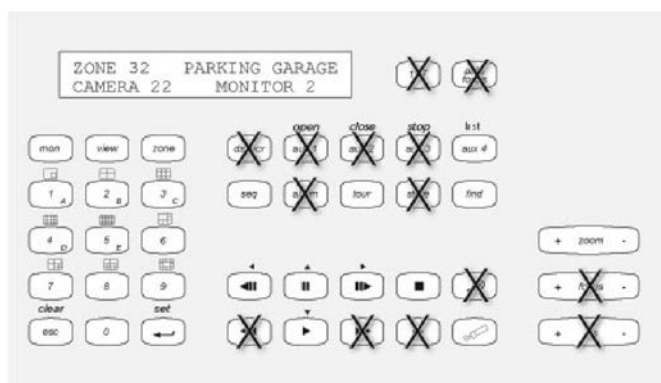









DSC/VCR	Autofocus	● (Record mode)
Aux 1	Alarm	Store
Aux 2	Iris +/-	▶▶ Fast forward
Aux 3	Focus +/-	◀◀ Fast backward
Aux 4	 (Magnification)	
Ist		

Operating the keypad



You can navigate the TVR 42 menus using the keypad buttons and joystick. However, not all maneuvers are available using the joystick.

See Table 21 on page 152 for the description of the DVR keypad mapping when using the KTD-405 keypad series. See Figure 43 above for a list of the keypad functions that are unavailable when connected to the TVR 42

Example 1: To enter your password in the login window using the keypad

1. In live view mode, press **esc** to activate the Login window.
2. Press and hold **esc** and then press the arrow buttons ( **down**,  **up**,  **left**,  **right**) to move the cursor to the Password edit box. Once in the password box, release **esc**.
3. Press **Enter** () to activate the virtual keyboard.
4. Press and hold **esc** and then press the arrow buttons to reach the first digit of the password. Release **esc** and press **Enter** () to select the digit.
Or move the joystick to the first digit of the password and press **Enter** ()
5. Repeat steps 2 to 4 for each digit of the password.
6. Move the cursor to the Enter button on the virtual keyboard and press **esc** on the KTD-405 keypad to enter the password.
7. Press and hold **esc** and then press the arrow buttons to navigate the cursor to activate OK button on the Login window.
8. Press . The main menu appears.

Example 2: To modify a menu option using the keypad









1. In the main menu press and hold **esc** and then press the arrow buttons to navigate to the desired menu icon (for example, Display Mode Settings).
2. Press  to enter **Display Mode Settings** menu.
3. Press **Zoom +** or **Zoom -** to scroll to the menu tab, **More Settings**.
4. When in the desired menu window, press and hold **esc** and then press the arrow buttons ( **up**,  **down**) to navigate the cursor to the option, **Menu Timeout**.







5. Press **↵** to activate the dropdown menu.
6. Press and hold **esc** and then press the up/down arrow buttons to navigate to the desired option.
7. Press **↵** to select the option.
8. Press and hold **esc** and then press the up/down arrow buttons to navigate to Apply. Press **↵** to select it. Then navigate to **Back** to return to live view.

Instead of the arrow buttons, you can also use the joystick on the keypad.

TVR 42 mapping to the KTD-405 keypad

Table 20: TVR 42 mapping to the KTD-405 keypad

Task	Keypad action	Further information
• Menu mode		
Call up or exit menu	In live view, press esc .	To logout of the menu: go to the Power Manager menu and select Logout.
Move through the menus	Press and hold esc and then press the arrow buttons or use the joystick.	 Down ,  Up ,  Left ,  Right
Move between menu tabs	Press Zoom + or Zoom - to switch between menu tabs.	
Navigate to a menu option	Press and hold esc and then press the arrow buttons.	 Down ,  Up ,  Left ,  Right
Select a character or menu option	Press Enter (↵).	Note. If you press esc before pressing Enter , you quit the menu without saving any changes. It is the same as Cancel.
Select the zone ID	Press zone to connect the keypad to the DVR.	
• Live view mode		
Call up a single camera	Press 0 to 9 and then press Enter (↵).	Using the numeric buttons 0 to 9 , enter the number of the camera and then press Enter (↵).
Call up multiview screens	Press view and then continue to press button 5 to scroll through the options available.	
Sequence through cameras	Press the seq button to scroll through the cameras in full screen.	
Switch to next/previous camera	Move the joystick to the right (= next camera), or the left (= previous camera)	

Task	Keypad action	Further information
Switch between monitor A and monitor B	Press the mon button and button 1 to switch to monitor A. Press the mon button and button 2 to switch to monitor B.	
Manually acknowledge an alarm	Press Alarm .	
• PTZ functions		
Enter PTZ mode	In live view mode, press Enter (↵).	It is possible that you first need to login before you can access the PTZ mode.
PTZ functions (Up, Down, Left, Right, Zoom in, Zoom out)	Move the joystick to move the dome up, down, left and right Press zoom+ and zoom- .	KTD-405U : Turn the knob on the joystick to zoom in/zoom out. KTD-405-2DU : Press the zoom+ and zoom- buttons.
Leave PTZ mode	Press esc .	
• Playback functions		
Search for recorded video	Press  .	Once password is entered, the Advanced Search menu appears.
All-day playback	Press  when in full screen.	All-day playback of the currently selected camera.
Stop playback	Press  to stop playback and return to live view mode.	
Pause playback	Press  to pause playback. Press  to restart.	
Select one of the files in the search result screen	Press enter (↵) and move the joystick to the desired file. Press  to start playback.	
Change playback speed	Press and hold esc and then press the left/right arrow buttons or move the joystick to the left/right.	
Jump 30 seconds forwards or backwards during playback	Press and hold esc and then press the up/down arrow buttons or move the joystick to the left/right.	

Selecting a camera using the keypad

The TVR 42 can support up to 16 analog cameras. To be able to control up to 16 cameras using the keypad, you may need to change the number of TVR 42 camera inputs controlled by the keypad. The default number of TVR 42 camera inputs controlled by the keypad is 16.

To change the number of TVR 42 camera inputs controlled by the keypad:

1. Hold down the Enter button (↵) until a beep sounds and then enter the following code: **1 4 7 6**. Push the **seq** button to confirm.
2. Scroll through the menus with the **▶** button until this menu appears:

```
ENTER ZONE ADDRESS: 01
(01-32)                ◀◀NEXT▶▶
```

3. Enter the DVR address to be configured and press ↵.
4. Scroll through the menus with the **▶** button until this menu appears:

```
ZONE 01 HUB:           DVMRE DUP
(↑,↓)=SELECT          ◀◀NEXT▶▶
```

5. Press the up/down arrow buttons to navigate to SYM DVR.
6. Scroll through the menus with the **▶** button until this menu appears:

```
ZONE 01 CAM. INPUTS   16
(↑,↓)=SELECT          ◀◀NEXT▶▶
```

7. Press the up/down arrow buttons to navigate to 32.
8. Repeat steps 3 to 7 for each DVR address in the keypad.

Controlling a camera

When setting up and controlling your cameras in zone mode, refer to Table 22 on page 155 for the list of default PTZ addresses associated with a zone ID. This value is automatically populated in the system. You can modify the PTZ address in the PTZ menu to meet customer requirements (see “Configuring PTZ settings” on page 47).

Table 21: Default PTZ camera addresses by zone ID

Camera input	Zone ID of TVR 42															
	1	2	3	4	5	6	7	8	9	10	11	12	13	14	15	16
1	0	32	64	96	128	160	192	224	256	288	320	352	384	416	448	480
2	1	33	65	97	129	161	193	225	257	289	321	353	385	417	449	481
3	2	34	66	98	130	162	194	226	258	290	322	354	386	418	450	482
4	3	35	67	99	131	163	195	227	259	291	323	355	387	419	451	483
5	4	36	68	100	132	164	196	228	260	292	324	356	388	420	452	484
6	5	37	69	101	133	165	197	229	261	293	325	357	389	421	453	485
7	6	38	70	102	134	166	198	230	262	294	326	358	390	422	454	486
8	7	39	71	103	135	167	199	231	263	295	327	359	391	423	455	487
9	8	40	72	104	136	168	200	232	264	296	328	360	392	424	456	488
10	9	41	73	105	137	169	201	233	265	297	329	361	393	425	457	489
11	10	42	74	106	138	170	202	234	266	298	330	362	394	426	458	490
12	11	43	75	107	139	171	203	235	267	299	331	363	395	427	459	491
13	12	44	76	108	140	172	204	236	268	300	332	364	396	428	460	492
14	13	45	77	109	141	173	205	237	269	301	333	365	397	429	461	493
15	14	46	78	110	142	174	206	238	270	302	334	366	398	430	462	494
16	15	447	79	111	143	175	207	239	271	303	335	367	399	431	463	495
17	16	48	80	112	144	176	208	240	272	304	336	368	400	432	464	496
18	17	49	81	113	145	177	209	241	273	305	337	369	401	433	465	497
19	18	50	82	114	146	178	210	242	274	306	338	370	402	434	466	498
20	19	51	83	115	147	179	211	243	275	307	339	371	403	435	467	499
21	20	52	84	116	148	180	212	244	276	308	340	372	404	436	468	500
22	21	53	85	117	149	181	213	245	277	309	341	373	405	437	469	501
23	22	54	86	118	150	182	214	246	278	310	342	374	406	438	470	502
24	23	55	87	119	151	183	215	247	279	311	343	375	407	439	471	503
25	24	56	88	120	152	184	216	248	280	312	344	376	408	440	472	504
26	25	57	89	121	153	185	217	249	281	313	345	377	409	441	473	505
27	26	58	90	122	154	186	218	250	282	314	346	378	410	442	474	506
28	27	59	91	123	155	187	219	251	283	315	347	379	411	443	475	507
29	28	60	92	124	156	188	220	252	284	316	348	380	412	444	476	508
30	29	61	93	125	157	189	221	253	285	317	349	381	413	445	477	509
31	30	62	94	126	158	190	222	254	286	318	350	382	414	446	478	510
32	31	63	95	127	159	191	223	255	287	319	351	383	415	447	479	511

Appendix E

Maximum pre-recording times

The maximum pre-recording time that can be selected depends on the bit rate. Frame rate, resolution and image quality do not impact time.

Note: This information only applies when the bit rate is set to Constant (see “Initializing recording settings” on page 89 for more information).

Constant bit rate	Maximum pre-recording time (seconds)
32	30
48	30
64	30
80	30
96	30
128	30
160	30
192	30
224	30
256	30
320	30
384	30
448	30
512	30
640	30
768	30
896	30
1024	30
1280	25
1536	20

Constant bit rate	Maximum pre-recording time (seconds)
1792	15
2048	15
3072	10
4096	5

Appendix F

Supported PTZ commands

Table 22: Supported PTZ commands by camera protocols (Part 1)

Protocol	PTZ command												
	Tilt up	Tilt down	Pan left	Pan right	Left up	Left down	Right up	Right down	Auto pan	Zoom +	Zoom -	Focus +	Focus -
Interlogix-485	Y	Y	Y	Y	N	N	N	N	N	Y	Y	Y	Y
Interlogix-422	Y	Y	Y	Y	N	N	N	N	N	Y	Y	Y	Y
KALATEL	Y	Y	Y	Y	N	N	N	N	N	Y	Y	Y	Y
DSCP	Y	Y	Y	Y	N	N	N	N	N	Y	Y	Y	Y
HIKVISION	Y	Y	Y	Y	Y	Y	Y	Y	Y	Y	Y	Y	Y
Honeywell	Y	Y	Y	Y	N	N	N	N	N	Y	Y	Y	Y
INFINOVA	Y	Y	Y	Y	N	N	N	N	N	Y	Y	Y	Y
KTD-348	Y	Y	Y	Y	N	N	N	N	N	Y	Y	Y	Y
LG MULTIX	Y	Y	Y	Y	N	N	N	N	N	Y	Y	Y	Y
LILIN	Y	Y	Y	Y	N	N	N	N	N	Y	Y	Y	Y
PANASONIC_CS850	Y	Y	Y	Y	N	N	N	N	N	Y	Y	Y	Y
PELCO-D	Y	Y	Y	Y	Y*	Y*	Y*	Y*	Y	Y	Y	Y	Y
PELCO-P	Y	Y	Y	Y	Y*	Y*	Y*	Y*	Y	Y	Y	Y	Y
PHILIPS	Y	Y	Y	Y	N	N	N	N	N	Y	Y	Y	Y
PHILIPS-3	Y	Y	Y	Y	N	N	N	N	N	Y	Y	Y	Y
SAE	Y	Y	Y	Y	N	N	N	N	N	Y	Y	Y	Y
Samsung	Y	Y	Y	Y	N	N	N	N	N	Y	Y	Y	Y
Siemens	Y	Y	Y	Y	N	N	N	N	N	Y	Y	Y	Y
SONY-EVI-D30/31	Y	Y	Y	Y	N	N	N	N	N	N	N	N	N
SONY-EVI-D70	Y	Y	Y	Y	N	N	N	N	N	N	N	N	N
SONY-EVI-D100/P	Y	Y	Y	Y	N	N	N	N	N	N	N	N	N
TECHWIN	Y	Y	Y	Y	N	N	N	N	N	N	N	N	N
VICON	Y	Y	Y	Y	N	N	N	N	N	Y	Y	Y	Y

Protocol	PTZ command												
	Tilt up	Tilt down	Pan left	Pan right	Left up	Left down	Right up	Right down	Auto pan	Zoom +	Zoom -	Focus +	Focus -
YOULI	Y	Y	Y	Y	N	N	N	N	N	Y	Y	Y	Y

*: Hikvision only.

Table 23: Supported PTZ commands by camera protocols (Part 2)

Protocol	PTZ command										
	Iris+	Iris-	Light	Wiper	Zoom area	Center	Menu	Preset	Tour	Shadow tour	
Interlogix-485	Y	Y	N	N	N	N	N	Y	N	Y	
Interlogix-422	Y	Y	N	N	N	N	N	Y	N	Y	
KALATEL	Y	Y	N	N	N	N	N	Y	N	Y	
DSCP	Y	Y	N	N	N	N	N	Y	N	Y	
HIKVISION	Y	Y	N	N	Y	Y	Y	Y	Y	Y	
Honeywell	Y	Y	N	N	N	N	N	N	N	N	
INFINOVA	Y	Y	N	N	N	N	N	Y	N	Y	
KTD-348	Y	Y	N	N	N	N	N	Y	N	Y	
LG MULTIX	Y	Y	N	N	N	N	N	Y	Y	Y	
LILIN	Y	Y	N	N	N	N	N	N	N	N	
PANASONIC_CS850	Y	Y	N	N	N	N	N	Y	N	Y	
PELCO-D	Y	Y	Y**	Y#	N	N	N	Y	Y	Y	
PELCO-P	Y	Y	N	N	N	N	N	Y	Y	Y	
PHILIPS	Y	Y	N	N	N	N	N	N	N	N	
PHILIPS-3	Y	Y	N	N	N	N	N	N	N	N	
SAE	Y	Y	N	N	N	N	N	Y	Y	Y	
Samsung	Y	Y	N	N	N	N	N	Y	N	Y	
Siemens	Y	Y	N	N	N	N	N	Y	N	Y	
SONY-EVI-D30/31	N	N	N	N	N	N	N	N	N	N	
SONY-EVI-D70	N	N	N	N	N	N	N	N	N	N	
SONY-EVI-D100/P	N	N	N	N	N	N	N	N	N	N	
TECHWIN	Y	Y	N	N	N	N	N	Y	N	N	
VICON	Y	Y	N	N	N	N	N	N	N	N	
YOULI	Y	Y	N	N	N	N	N	Y	N	N	

** : Aux. 2

: Aux. 1

Appendix G

Default menu settings

Display mode setting	
Monitor	
General	
	Language: English
	Device Name: TVR 42
	Device Address: 255
	Zone ID: 1
	VGA Resolution: 1280*1024/60HZ
	HDMI Resolution : 1920*1080/60HZ(1080P)
	Password Required : Yes
	Scale Output Video: Yes
	Enable Wizard: Yes
	Display Status Icon: Yes
More Settings	
	Monitor Standard: NTSC/PAL. Auto detect at booting.
	Output Mode: Standard
	Monitor Brightness: 5
	Event Hint: Yes
	Time Bar Transparent: Yes
	Enable Timebar: Yes
	Menu Timeout: 5 min
	Mouse Pointer Speed: Lower
	Other Notification: Panel Alarm LED
	Motion Alarm: No
	Instant Playback Time: 5 Minutes
	Enable Lockout Lock: No
	Disable Network Disconnect Alarm: Yes

Layout	
General	
	Video Output Interface: VGA/HDMI
	Live View Mode: 2*2
	Dwell Time: No Switch
	Enable Audio Output: No
	Event Output: VGA/HDMI
	Event Full Screen Monitoring Dwell Time(s): 10 s
	Alarm Full Screen Monitoring Dwell Time(s): 10 s
View	
	Video Output Interface: VGA/HDMI
	16 Chan: 4*4 -A1 to A16
	8 Chan: 3*3 - A1 to A8+1black screen
	4 Chan: 2*2 - A1 to A4
Time	
Time Settings	
	Time Zone: GMT -8
	Date Format: MM-DD-YYYY
	Time Format: 12-hr
	Display Week: No
	System Date: Current system date
	System Time: Current system time
	Auto DST Adjustment: No
	Enable DST: No
	From: Apr 1st Sun 2:00
	To: Oct last Sun 2:00
	DST bias: 60 min
Holiday	
Holiday Settings	
	Status: All disable; Start date: 1st. Jan; End date: 1st Jan
Camera Management	
OSD	
OSD Settings	
	Camera: Analog 1
	Camera Name: Camera 01
	Display Name: Yes
	Display Date: Yes

	Display Week: Yes
	Date Format: MM-DD-YYYY
	Time Format: 12-hour
	Display Mode: Not Transparent & Not Flashing
Image	
	Image Settings
	Camera: Analog 1
	Mode: Customize
Motion	
	Motion Detection Settings
	Camera: Analog 1
	Enable Motion Detection: No
	Rule: Trigger Channel [Camera 1]; Arming Schedule: All day for whole week; Rule: (Null)
	Sensitivity: Middle
	Target Size: 1
	Zone: Full Screen
Privacy Mask	
	Privacy Mask Settings
	Camera: Analog 1
	Enable privacy mask: No
	Zone: (Null)
Tamper-proof	
	Tamper-proof Settings
	Camera: Analog 1
	Enable Tamper-proof: No
	Rule: Alarm schedule all day for whole week; Rule: (Null)
	Sensitivity: Low
	Zone: (Null)
Video Loss	
	Video Loss Settings
	Camera: Analog 1
	Enable Video Loss Alarm: Disable
	Rule: Alarm schedule all day for whole week; Rule: (Null)
Covert Camera	
	Covert Camera Settings
	Camera: (Null)

Video Schedule	
Schedule	
	Record
	Camera: Analog 1
	Enable Schedule: Yes
	Schedule: All day for whole week TL-Hi
Encoding	
	Record
	Camera: Analog 1
	Encoding Parameters: Mainstream (TL-Hi)
	Stream Type: Video-Audio
	Resolution: 2CIF
	Bit Rate Type: Constant
	Video Quality: Medium
	Frame Rate: 4 fps
	Max. Bit Rate Mode: General
	Max. bit rate: 96
	Pre-record: 5s
	Post-record: 5s
	Auto Delete (day): 0
	Redundant Record/Capture: No
	Record audio: Yes
	Capture
	Camera: Analog 1
	Resolution: 4 CIF
	Picture quality: Medium
	V-stream Encoding
	Enable V-stream Encoding: No
	Frame Rate : 25 fps
	Max. Bit Rate: 1792
	Encode Parameters Suggestion
	Duration Time (days): 30
	Weekday: Yes
	Weekend: Yes
	Resolution: 704*240(2CIF)
	Total capacity: (It depends)
	Free Space: 0 MB
	Calculate: (Null)

		Frame Rate: (Null)
		Bitrate (Kbps): (Null)
Auto Archive		
	Archive Settings	
		Enable Auto Archive: No
		Start Time:
		End Time:
		Interval Time: Once Only
		Device Full Rule: Stop Archiving
		Device Select: SATA1 CD/DVD-RW
	Archive Status	
		(Null)
	Manual Record	
		Cameras: All Off
More Settings		
	More Settings	
		Event Priority: Text In < Motion
		Overwrite: Yes
		eSATA: Export
Network Settings		
	General	
		General
		NIC Type: 10M/100M/1000M Self-adaptive
		Enable DHCP: No
		IPv4A: (It depends)
		IPv4 Subnet Mask: 255.255.255.0
		IPv4 Default Gateway: 192.168.1.1
		IPv6 Address1: (It depends)
		IPv6 Address2: (Null)
		IPv6 Address Gateway: (Null)
		MAC Address: (It depends)
		MTU: 1500
		Preferred DNS Server: (Null)
		Alternate DNS Server: (Null)
PPPoE		
	PPPoE	
		Enable PPPoE: No
		User name: (Null)

		Password: (Null)
		Confirm: (Null)
DDNS		
	DDNS	
		DDNS: No
		DDNS Type: ezDDNS
		Server Address: www.tvr-ddns.net
		Host Name: (Null)
NTP		
	NTP	
		Enable NTP: No
		Interval: 60min
		NTP Server: time.nist.gov
		NTP Port:123
Email		
	Email	
		Enable Server Authentication: No
		User Name: (Null)
		Password: (Null)
		SMTP Server: (Null)
		SMTP port: 25
		Enable SSL: No
		Sender: (Null)
		Sender's Address: (Null)
		Select Receivers: Receiver 1
		Receiver: (Null)
		Receiver's Address: (Null)
		Enable Attached Picture: No
		Interval: 2s
FTP		
	FTP	
		Enable FTP: No
		FTP Server: (Null)
		FTP Port: (Null)
		User Name: (Null)
		Password: (Null)
		Directory: Use Root Directory
		Parent Directory: (Null)

		Secondary directory: (Null)
SNMP		
SNMP		
		Enable SNMP: No
		SNMP Version: V2
		SNMP Port: 161
		Read Community: Public
		Write Community: Private
		Trap Address: (Null)
		Trap Port: 162
UPnP		
UPnP		
		Enable UpnP: No
		Mapped type: Manual
More Settings		
More Settings		
		Alarm Host IP 1: (Null)
		Alarm Host Port 1: 0
		Alarm Host IP 2: (Null)
		Alarm Host Port 2: 0
		Server Port: 8000
		HTTP Port: 80
		Multicast IP: (Null)
		RTSP Server Port: 554
		Enable Telnet: No
Alarm Settings		
Alarm List		
Alarm Inputs		
		No.: (Null)
		Alarm Name: (Null)
		Alarm Type: NO
Alarm Outputs		
		No.: (Null)
		Alarm Name: (Null)
		Time Out: 5 s

Alarm Input	
Alarm Input	Alarm Input No.: A<1
	Alarm Name: (Null)
	Type: NO
	Enable Alarm Input: No
	Rule: Trigger channel (None); Arming schedule (All day for whole week); Rule (Null); PTZ linking: (Null)
Alarm Output	
Alarm Output	Alarm Output No.: A>1
	Alarm Name: (Null)
	Time Out: 5 s
	Rule: All day for whole week
Manual Alarm	Trigger None
Alarm Audio	
Alarm Audio: (File No., File Name, Size)	
Alarm Output: HDMI	
Notification	
Notification	Notification Type: HDD full
	Audible Warning: No
	Notify Surveillance Center: No
	Send Email: No
	Trigger Alarm Output: No
Advanced Settings	
Advanced Settings	System Buzzer Time: Constant
	Camera Buzzer Time: Mute
PTZ setting	
General	General
	Camera: Analog 1
	Baud Rate: 9600
	Data Bit: 8
	Stop Bit: 1
	Parity: None

		Flow ctrl: None
		PTZ protocol: Interlogix 485
		Address: 1
	More settings	
		(Null)
User Management		
	User	
		User Management
		admin: (Null)
		operator: (Null)
		guest: (Null)
	Change Password	
		(Null)
System Settings		
	RS-232	
		RS-232 Settings
		Baud Rate: 57600
		Data Bit: 8
		Stop Bit: 1
		Parity: None
		Flow CTRL: None
		Usage: ProBridge
	Hard Disk	
		HDD Information: Label, Capacity, Status, property, Type, Free Space, Group, Edit, Delete
		Storage Mode
		Mode
		Dual Streaming: Capacity Ratio
		Group: Record on HDD Group (All)
	S.M.A.R.T. Settings	
		Use when the disk has failed to self-evaluate: No
		HDD No.: (It depends)
		Capacity: (It depends)
		Serial No.: (Null)
		Temperature (°C): (Null)
		Power Up (days): 306
		Self-evaluation: Pass
		All-evaluation: Functional

	S.M.A.R.T. Information: ID, Attribute Name, Status, Flags, Threshold, Value, Worst, Raw VAlue
Bad Sector Detection	
	HDD No.: (It depends)
	Key Area Detection: Detect
	HDD Capacity: (Null)
	Block Capacity: (Null)
	Status: Not tested
	Error Count: (Null)
Text Insertion	
Text Insertion	
	Enable Text Insertion: No
	Access Device: ATM/POS
	Access Mode: Probridge
	Start Setting: (Null)
Upgrade	
Local Upgrade	
	Device Name: SATA1 CD/DVD-R/W
	FTP: (Null)
Configuration	
Import/export Config File	
	Device Name: SATA1 CD/DVD-R/W
	Default : (Null)
Log Search	
Log Search	
	Start Time: (Date), 00:00:00
	End Time: (Date), 23:59:59
	Major Types: All
	Minor Types: All
System Information	
Device Info	
	Device Name, Model, Serial No., Firmware Version, Encoding Version, Panel Version, Net Detect
Camera	
	Camera No., Camera Name, Status, Motion Detection, Tamper-proof, Video Loss, Video Notification, Preview Link Sum, Preview Link Info

Record	
	Camera No., Camera Name, Stream Type, Frame Rate, Bitrate (Kbps), Resolution, Record Type, Encoding Parameter, Redundant
Alarm	
	No., Alarm Name, Alarm Type, Alarm Status, Triggered Camera
Network	
	NIC, IPv4 Address, IPv4 Subnet Mask, IPv6 Address 1, IPv6 Address 2, IPv6 Default Gateway, Preferred DNS Server, Alternate DNS Server, Enable DHCP, Enable PPPoE, PPPoE Address, PPPoE Subnet Mask, PPPoE Default Gateway, MAC Address
HDD	
	Label, Status, Capacity, Free Space, Property, Type, Group
Net Detect	
Traffic	
Network Detection	
	Select NIC: LAN1
	Destination Address: (Null)
	Device Name: SATA1 CD/DVD-R/W
Network stat.	
	Remote Live View: 0 bps
	Remote Playback: 0 bps
	Net total Idle: 80 Mbps
	Net total Limit: 80 Mbps

Index

A

- Active X, 73
- Alarm audio messages, 101
- Alarm notifications
 - alarm audio messages, 101
 - external alarms, 106
 - modifying the warning buzzer, 103
 - types, 100
 - video loss, 109
 - video tampering, 110
- Alarm outputs
 - manually acknowledging, 108
- Alarm/event sequencing, 42
- Archiving
 - manually exporting files to a backup device, 68
 - quick archive, 67
 - schedule automatic archiving, 70
 - snapshots, 72
 - video clips, 71
- Audio
 - connecting audio inputs and outputs, 10
 - recording audio, 89
- Audio enable/disable
 - quick access, 37
- Auto-delete
 - configuring, 89
- Automatically archiving files, 70

B

- Back panel description, 8
- Backup devices
 - managing, 72
- Bandwidth throttle
 - configuring, 120
- Bit rate
 - configuring, 89
- Bit rates
 - calculating maximum permitted rates, 91
- Bookmarks
 - playback, 62
 - saving, 62
 - types, 62
- Brightness, contrast and saturation

modifying, 130

C

- Cameras
 - configuring PTZ dome cameras, 47
 - connecting analog cameras using loop-through, 10
 - privacy masking, 129
 - setting up alarm/event sequencing, 42
 - setting up sequencing, 41
- Covert cameras, 130

D

- Daily schedules
 - recording, 94
- Date
 - configuring display, 42
- DDNS settings, 113
- Default menu settings, 160
- Digital zoom
 - description, 39
 - quick access, 37
 - quick access, 56
 - web browser, 81
- Digital zoom in playback, 66
- Disk analysis
 - searching recorded video, 126
- DST
 - set up, 42
- Dual streaming
 - browser, 82
 - recording, 123
- Dwell time, 39
 - alarms and events, 39

E

- E-mail notifications
 - set up, 114
- Encoding parameters
 - configuring, 89
- eSATA, 125
- Event logs
 - searching remotely, 82
- Export configuration settings, 138
- Export files, 72

- External alarm
 - setting up to record when triggered, 106
- External alarm schedules
 - recording, 96

F

- Factory default settings
 - restore, 134
- Firmware
 - updating, 133
- Frame rates
 - calculating maximum permitted rates, 91
- Frame-by-frame playback, 66
- Front panel description, 25
- FTP server settings, 117
- Full screen viewing, 36

H

- HDD
 - calculating maximum required space, 91
 - checking status, 124
 - grouping, 122
 - properties, 123
 - quota, 121
 - redundancy, 98
 - set to read only, 98
 - setting up HDD alarms, 124
- Holiday schedules
 - recording, 95
- HTTP port settings, 118

I

- Image settings
 - quick access, 37
- Import configuration settings, 138
- Instant playback, 57
 - change default time, 57
 - quick access, 37

K

- Keypad
 - connecting to RS-485 port, 9
 - wiring to DVR, 16
- KTD-405
 - changing the camera inputs controlled by the keypad, 154
- KTD-405 keypad
 - accessing DVR functions, 151
 - controlling a camera, 154
 - firmware supported, 148
 - set up in zone mode, 149
 - set up TVR 42 device address, 149
 - wiring, 148

L

- Live view mode

- digital zoom, 39
- full screen view, 36
- multiview, 36
- sequencing cameras, 37
- time and date display, 42
- Lock/unlock recorded files, 97
- Logs
 - view system log, 137

M

- Main menu
 - accessing, 30
 - description, 30
 - icon descriptions, 30
- Manual recording, 95
 - quick access, 37
- Manually archiving files, 68
- Monitors
 - connecting, 10
 - select main and spot monitors, 39
- Motion detection, 103
 - defining motion detection area, 103
 - setting the sensitivity level, 103
 - setting the target size, 103
- Motion search
 - playback, 65
- Motion search toolbar
 - quick access, 56
- Mouse pop-up menu, 34
- Multicast settings, 117
- Multiview, 36

N

- NAS, 87
- Network packet data
 - exporting, 119
- Network settings
 - general set up, 111
- Network status, 118
- Network storage system
 - set up, 87
- Network traffic
 - checking, 118
- Notifications
 - external alarms, 106
 - system event types, 108
- NTP server, 114

O

- OSD settings, 128
- Overwriting
 - Protecting recorded files, 96

P

- Password
 - changing user password, 142

- default user passwords, 139
- Playback
 - bookmarks, 62
 - changing playback speed, 66
 - instant playback, 57
 - interface overview, 54
 - motion search, 65
 - playing back archived files, 72
 - pop-up menu description, 56
 - reverse playback, 80
 - search by event, 61
 - search by time, 60
 - search by video type, 60
 - search results, 59
 - set up for text insertion, 61
 - skip time, 65
 - snapshots, 63
 - system log, 64
 - using digital zoom, 66
 - using the web browser, 80
- Playback control toolbar
 - description, 55
 - quick access, 56
- Player
 - using for playback, 72
- Player tool
 - Web browser playback, 80
- Port forwarding, 74, 146
- Power up and down DVR, 19
- PPPoE settings, 112
- Pre and post recording times
 - configuring, 89
- Pre-recording times
 - maximum times, 156
- Preset tours
 - call up, 51
 - quick access, 48
 - set up, 51
- Presets
 - call up, 50
 - quick access, 48
 - set up, 50
- Privacy masking, 129
- Protecting recorded files, 96
- PTZ control panel
 - description, 48
 - quick access, 37
- PTZ dome cameras
 - assigning protocols, 47
 - configuring, 47
 - connecting to RS-485 port, 9
 - controlling remotely, 84
 - set up, 12
- PTZ protocols, 145
 - assigning, 47
 - configuring Interlogix cameras, 12
 - PTZ commands supported, 158

R

- Recorded files
 - lock/unlock, 97
 - Protect HDD, 98
- Recording
 - calculating maximum frame rates and bit rates, 91
 - configuring settings, 89
 - protecting against overwriting, 96
 - recording schedules, 93
 - setting up HDD redundancy, 98
- Recording schedules
 - daily, 94, 95
 - defining, 93
 - external alarms, 96
- Remote alarm host settings, 117
- Remote control
 - connect to the DVR, 29
 - description, 28
- Resolution
 - configuring, 89
- RS-232 port
 - configuring, 132
- RTSP service port, 118

S

- S.M.A.R.T. information on a HDD, 125
- SAN, 87
- Sequencing cameras, 37, 41
 - dwell time, 39
- Setup wizard
 - using, 20
- Shadow tours
 - quick access, 48
 - set up, 52
- Skip time
 - playback, 65
 - quick access, 56
- Snapshots
 - archiving, 72
 - capture remotely, 80
 - capturing, 37
 - playback, 63
 - upload to FTP server, 117
- SNMP protocol settings, 116
- Soft keyboard, 32
- Stream type
 - configuring, 89
- System information
 - view, 134
- System logs
 - playback, 64
 - view, 137
- System notifications
 - event types, 108

T

Text insertion

- quick access to display, 56
- search recorded video, 84
- set up, 84

Text overlay

- browser, 86

Time

- configuring display, 42

U

User privileges

- camera configuration, 141
- descriptions, 140
- local configuration, 140
- remote configuration, 141

Users

- adding a new user, 139
- customizing user privileges, 140
- deleting a user, 142
- managing, 139
- modifying user information, 142
- user levels, 139

V

Video format

- PAL/NTSC, 19

Video loss

- setting up detection, 109

Video tampering

- setting up to detect, 110

View system log, 137

V-stream encoding, 46

W

Warning buzzer

- modifying, 103

Watermaking, 130

Web browser

- accessing, 74
- digital zoom, 81
- dual streaming, 82
- local configuration of DVR, 76
- ports, 74
- remote configuration of DVR, 77
- searching and playing back recorded video, 80
- searching for event logs, 82
- text insertion, 84
- text overlay, 86
- video snapshot, 80