

SymDec 16 plus 4 User Manual



Copyright Copyright © 2008, GE Security, Inc. All rights reserved.

This document may not be copied in whole or in part or otherwise reproduced without prior written consent from GE Security except where specifically permitted under US and international copyright law.

Document number/Revision: **0150-0325C** (January 2008).

Disclaimer The information in this document is subject to change without notice. GE Security, Inc. ("GE Security") assumes no responsibility for inaccuracies or omissions and specifically disclaims any liabilities, losses, or risks, personal or otherwise, incurred as a consequence, directly or indirectly, of the use or application of any of the contents of this document. For the latest documentation, contact your local supplier or visit us online at www.gesecurity.com.

This publication may contain examples of screen captures and reports used in daily operations. Examples may include fictitious names of individuals and companies. Any similarity to names and addresses of actual businesses or persons is entirely coincidental.

Trademarks and patents GE and the GE monogram are registered trademarks of General Electric Company. The SymDec 16 plus 4 product and logo are registered trademarks of GE Security.

Other trade names used in this document may be trademarks or registered trademarks of the manufacturers or vendors of the respective products.

Software license agreement **Important:** This end-user license agreement ("Agreement") is a legal agreement between GE SECURITY and You. Read the following terms and conditions carefully before installing or using this Software. This agreement provides a license from GE SECURITY to use the Software. It also contains warranty information, disclaimers, and liability limitations. Installing and/or using the Software confirms Your agreement to be bound by these terms and conditions. If You do not agree with these terms and conditions, do not install or use the Software or, if already installed, immediately cease all use of the Software and promptly uninstall all components of the Software.

1. Definitions. The following definitions apply to this document:

- a. "GE SECURITY", with respect to title to or warranty of the Software, means GE Security Inc., a Delaware corporation.
- b. "Software" means SymNav, the executable software or firmware programs and accompanying documentation installed on the GE SECURITY products, plus any upgrades, modified versions, updates, additions, and copies of the software furnished to Customer during the term of the license granted herein.
- c. "Documentation" means all associated media, printed materials, and electronic documentation accompanying the Software.
- d. "Licensed Product" means the Software and Documentation.
- e. "Customer" means the person or organization, or parent or subsidiary thereof, who uses the Software for its intended purposes, and excludes distributors, authorized resellers, value-added resellers and original equipment manufacturers. Customer may be referred to as You or Your, whether an individual or a business entity of any kind.
- f. "Machine" means the computer, workstation, terminal, or other hardware product on which the Software is installed.

2. License. All rights to and in the Licensed Product, including, but not limited to, copyrights, patents, trademarks, and trade secrets, belong to GE SECURITY, and GE SECURITY retains title to each copy of the Software. You agree that GE SECURITY at any time, upon reasonable notice, may audit Your use of the Software for compliance with the terms and conditions of this Agreement. Subject to the terms and conditions of this Agreement, GE SECURITY grants You a nonexclusive license to use the Software, but only in the country where acquired, provided that You agree to the following:

You may:

- a. install and use the Software on a single Machine at one time, unless You have purchased additional copies of the Software, in which case You may install the software on the number of Machines for which You have purchased copies of the Software;
- b. use the original copy of the Software provided to You for backup purposes.

You may not:

- a. transfer or distribute the Licensed Product to others, in electronic format or otherwise, and this Agreement shall automatically terminate in the event of such a transfer or distribution;
- b. use the Software over a computer network;
- c. sell, rent, lease, or sublicense the Software;
- d. copy or modify the Licensed Product for any purpose, including for backup purposes.

3. Term. This Agreement is effective until terminated. You may terminate this Agreement by uninstalling all components of the Software from all Machines and returning the Software to GE SECURITY. GE SECURITY may terminate this Agreement if You breach any of these terms and conditions. Upon termination of this Agreement for any reason, You agree to uninstall all components of the Software and return the Licensed Product to GE SECURITY. All provisions of this Agreement relating to (i) disclaimer of warranties; (ii) limitations on liability, remedies, and damages; and (iii) GE SECURITY's proprietary rights, shall survive termination of this Agreement.

4. Object code. The Software is delivered in object code only. You may not alter, merge, modify, adapt, or translate the Software, nor decompile, disassemble, reverse-engineer, or otherwise reduce the Software to a human-perceivable form, nor create derivative works or programs based on the Software.

5. Limited warranty. GE SECURITY warrants that for one (1) year from the date of delivery of the Licensed Product (Software Warranty Period), the functions contained in the Software will be fit for their intended purpose as described in the applicable Documentation from GE SECURITY, and will conform in all material respects to the specifications stated in such Documentation. GE SECURITY does not warrant that the operation of the Software will be uninterrupted or error-free. GE SECURITY does warrant that the media on which the Software is furnished will be free from defects in materials and workmanship under normal use for a period of thirty (30) days from the date of delivery (Media Warranty Period). Except as specifically provided therein, any other software and any hardware furnished with or accompanying the Software is not warranted by GE SECURITY.

Your exclusive remedy under this limited warranty for nonconforming Software shall be repair or replacement of the Software, at the sole discretion of GE SECURITY. To obtain a repair or replacement of nonconforming Software, contact GE SECURITY Customer Service toll-free at 888-GESECURity or online at www.gesecurity.com during the Software Warranty Period.

Except as expressly provided above, the licensed product is provided "as is" without warranty of any kind, either expressed or implied, including, but not limited to, implied warranties of merchantability or fitness for a particular purpose and, except as expressly provided above, You assume the entire risk as to the quality and performance of the licensed product.

6. Limitation of liability. GE SECURITY's sole obligation or liability under this agreement is the repair or replacement of nonconforming software and/or defective media according to the limited warranty above. In no event will GE SECURITY be liable for damages, whether consequential, incidental, or indirect, nor for loss of data, loss of profits, or lost savings, arising from use or inability to use the software or documentation (or any hardware furnished with the software), even if GE SECURITY has been advised of the possibility of such damages, nor for any claim by any third party.

7. General. Any materials provided to You by GE SECURITY shall not be exported or reexported in violation of any export provisions of the USA or any other applicable jurisdiction. Any attempt to sublicense, assign, or transfer any of the rights, duties, or obligations hereunder shall be void. This Agreement shall be governed by and interpreted under the laws of the State of New York, United States of America, without regard to conflicts of law provisions. You hereby consent to the exclusive jurisdiction of the state and federal courts located in Multnomah County, Oregon, to resolve any disputes arising under or in connection with this Agreement, with venue in Portland, Oregon.

8. Restricted rights legend. The Licensed Product is provided with RESTRICTED RIGHTS. In the event the United States Government or an agency thereof is granted a license, the following additional terms apply: Restricted Computer Software, as defined in the Commercial Computer Software–Restricted Rights clause at Federal Acquisition Regulations 52.227-19, and the restrictions as provided in subparagraphs (c)(1) and (c)(2) thereof; and as applicable, the Government’s rights to use, modify, reproduce, release, perform, display, or disclose the Software also are restricted as provided by paragraphs (b)(2) and (b)(3) of the Rights in Noncommercial Technical Data and Computer Software–Small Business Innovative Research (SBIR) Program clause at DFARS 252.227-7018.

9. Acknowledgment. You acknowledge that You have read and understand this agreement and agree to be bound by its terms. You further agree that this agreement is the complete and exclusive statement of the agreement between You and GE SECURITY, and supersedes any proposal or prior agreement, oral or written, and any other communication relating to the subject matter of this agreement.

Intended use Use this product only for the purpose it was designed for; refer to the data sheet and user documentation. For the latest product information, contact your local supplier or visit us online at www.gesecurity.com.

Non-LPS or TNV output connectors identify the type of circuit, intended cable type, or relevant circuit characteristics. (Marking or Instruction)

FCC compliance This equipment has been tested and found to comply with the limits for a Class A digital device, pursuant to part 15 of the FCC Rules. These limits are designed to provide reasonable protection against harmful interference when the equipment is operated in a commercial environment. This equipment generates, uses, and can radiate radio frequency energy and, if not installed and used in accordance with the instruction manual, may cause harmful interference to radio communications.

You are cautioned that any changes or modifications not expressly approved by the party responsible for compliance could void the user’s authority to operate the equipment.

Regulatory   



CATUION: Risk of Explosion if Battery is replaced by an Incorrect Type. Dispose of Used Batteries According to the Instructions.

Chapter 1.	Introduction.....	1
	Introduction	2
	Conventions used in this document.....	2
	Safety terms and symbols.....	2
	Product overview.....	3
	Features.....	3
	Product contents	4
	Installation Environment	4
	Associated Equipment	5
	Rack Mounting.....	6
	Passwords.....	7
	Default IP Addresses	7
Chapter 2.	Connections and Controls	9
	Front Panel Controls and Features	10
	Back Panel Connections	12
	Camera Inputs.....	12
	Audio Inputs and Output	13
	Alarm Inputs.....	13
	USB connectors.....	13
	Ethernet Port	14
	RS-485/RS-422 I/O connectors	14
	RS232 Port	15
	VGA connector.....	15
	DVI connector	16
	Monitor A/B composite output.....	16
	Alarm out connector	16
	Power Connector	17
	Connection Diagrams.....	18
	The Remote Controller	20

Chapter 3. Basic Operations	21
Front Panel Controls	22
Operations	24
How to Log In	24
How to change the display for Monitor A and Monitor B	24
How to change the display to a full-screen analog view	24
How to change the display to a full-screen IP view	24
How to view multiscreen displays	24
How to change the display presets	25
How to enter Cameo mode	25
How to display Sequencing	25
How to return to the default sequence list	25
How to enter Playback mode	25
How to Search using Disk Analysis	26
How to Search using the Filters Screen	26
How to archive from the Search screen	26
How to use the Archive screen	27
How to setup and stream an IP camera to a SymDec 16	27
How to setup a KTD-405 keypad to work with the SymDec 16	28
How to set the IP camera option to a keypad button	28
KTD-405 keypad mapping to SymDec 16 front panel	29

Chapter 4. Programming the SymDec 16 plus 4	31
Log In	32
Main Menu	33
Cameras menu	35
Analog Camera menu	35
IP Camera menu	42
The Schedule menu	47
New Schedule	48
Macros	49
Create new Macro	50
Edit Macro	51
Front Panel	52
How to schedule a macro	52
The Alarms menu	54
Notification	54
Silent Alarm	55
Alarm Inputs and Outputs	55
The Users menu	57
Add New User	57
Edit Users	58
The Network menu	59
IP Settings	60
IP Advanced	61
Multicast Video Streaming Overview	62
Services	63
Streaming	64
Serial Passthrough	65
Email/TCP Notification	66
Email Setup	67
Notification Setup	68
The Display menu	69
The System menu	70
Front Panel	70
Audio Output	71
Time/Date	72
Security	74
Languages	75
Disk Tools	76
Serial Communications	78
Firmware Upgrade	80
Setting Tool	81
Shutdown	82
The Info menu	83
Health	83
System	84

	Network	85
	Log	86
Chapter 5.	SymNav and SymBrowser	87
	SymNav	88
	Minimum System Requirements	88
	Installing SymNav software from CD-ROM	88
	Starting SymNav software	88
	The SymBrowser Webserver	90
	Search	91
	User	92
	Configure options	93
	Cameras	94
	Schedule	102
	Alarms	104
	Network	106
	System	114
	Info	121
	Symbrowser	123
Chapter 6.	Searching and Archiving	125
	Searching	126
	The Disk Analysis Screen	126
	Search Filters	127
	Date and Time Search	127
	Camera Motion Search	128
	Daily Hours Search	128
	Search For Search	129
	Search Results	130
	Archiving	131
	Fullscreen Search Results Preview	132
	SymPlayer	133
Chapter 7.	Technical Specifications	135
	Technical Specifications	136
	General	136
	Connections	136
	Video	136
	Audio	137
	On-screen Video Indicators	137
	Part Numbers	137
	Factory Defaults	138
	Menu defaults	138
	IP addresses	138
	Streaming defaults	139

Chapter 8. Maintenance, support	141
Contacting technical support	142
Online publication library	142

x | SymDec 16 plus 4
User Manual

Chapter 1 Introduction

This chapter provides an overview of your SymDec 16 plus 4, including the box contents, the installation environment requirements and associated equipment you right require before you begin installing, configuring, and using your SymDec 16 plus 4.

In this chapter:

- Introduction*..... 2
 - Conventions used in this document* 2
 - Safety terms and symbols* 2
- Product overview* 3
 - Features* 3
 - Product contents*..... 4
 - Installation Environment* 4
 - Associated Equipment* 5
 - Rack Mounting* 6
 - Passwords*..... 7
 - Default IP Addresses* 7

Introduction

This is the *GE SymDec 16 plus 4 User Manual* for models:

- SymDec16 plus 4-320
- SymDec16 plus 4-640
- SymDec16 plus 4-1.28T
- SymDec16 plus 4-2T
- SymDec16 plus 4-3T

This document includes an overview of the product and detailed instructions explaining how to install and configure the SymDec 16 plus 4.

There is also information describing how to contact technical support if you have questions or concerns.

To use this document effectively, you should have the following minimum qualifications:

- a basic knowledge of CCTV systems and components; and
- a basic knowledge of electrical wiring and low-voltage electrical connections.

Read these instructions and all ancillary documentation entirely before installing or operating this product. The most current versions of this and related documentation may be found on our website. Refer to [Online publication library](#) on page 142 for instructions on accessing our online publication library.

Note: A qualified service person, complying with all applicable codes, should perform all required hardware installation.



Conventions used in this document

The following conventions are used in this document:

Bold	Menu items and buttons.
<i>Italic</i>	Emphasis of an instruction or point; special terms.
	File names, path names, windows, panes, tabs, fields, variables, and other GUI elements.
	Titles of books and various documents.
Monospace	Text that displays on the computer screen.
	Programming or coding sequences.
<i>Blue italic</i>	Hyperlinks to cross-references, related topics, and URL addresses.

Safety terms and symbols

These terms may appear in this manual:

 CAUTION	<i>Cautions</i> identify conditions or practices that may result in damage to the equipment or other property.
 WARNING	<i>Warnings</i> identify conditions or practices that could result in equipment damage or serious personal injury.

Product overview

The SymDec 16 plus 4 is a 16-channel Digital Video Recorder that uses “hybrid” recording that works with both conventional analog cameras (16) and the new family of GE IP products. This unique platform provides a graceful migration path to digital recording – the future of video recording.

The SymDec 16 plus 4 allows users to record full-size images at full speed on every channel. Using MPEG-4 compression, the SymDec 16 plus 4 records at 30, 15, 10, 5, and 2 frames per second (NTSC) and has virtual triplex functionality for simultaneous viewing, playback, and recording of video.

Note: In PAL video mode the SymDec 16 plus 4 can record at 25, 12.5, 8.3, 5, and 2.1 fps.

The SymDec 16 plus 4 has a form factor that’s one rack unit wide by 2U high, so it fits easily into a standard 19-inch rack. All models of the SymDec 16 plus 4 are equipped with a built-in DVD recorder, which allows for portable storage or evidence transfer. In addition, the SymDec 16 plus 4 can be easily networked and recorded video viewed remotely over Ethernet.

Features

- View live and recorded video from multiple SymDec 16 plus 4’s using SymNav software
- Advanced MPEG4 video compression
- 16-channel composite video input/output connection
- 9 video quality settings
- Triplex functionality
- Auto-detect video mode (NTSC or PAL) on startup
- VGA, DVI, and composite video outputs
- Records up to 30 frames per second (NTSC) of real time video
- Records up to 25 frames per second (PAL) of real time video
- Multi-level password protection
- Continuous recording in disk overwrite mode
- A simple on-screen display (OSD) menu system
- Remote configuration over TCP/IP
- Clock synchronization with network server
- Timed recording
- Dynamic IP addressing (DHCP)
- Support for Dynamic Domain Name Server (DDNS)
- Local search on time, date, and hardwired alarms
- Alarm handling with history log
- Unique at-a-glance alarm indicators
- Alarm notification through email
- Motion detection support
- Programmable Auto Delete Mode (ADM)
- Hard disk monitoring features
- Video streaming with UDP (User Datagram Protocol) and TCP (Transmission Control Protocol) support

Figure 1. SymDec 16 plus 4 contents unboxed

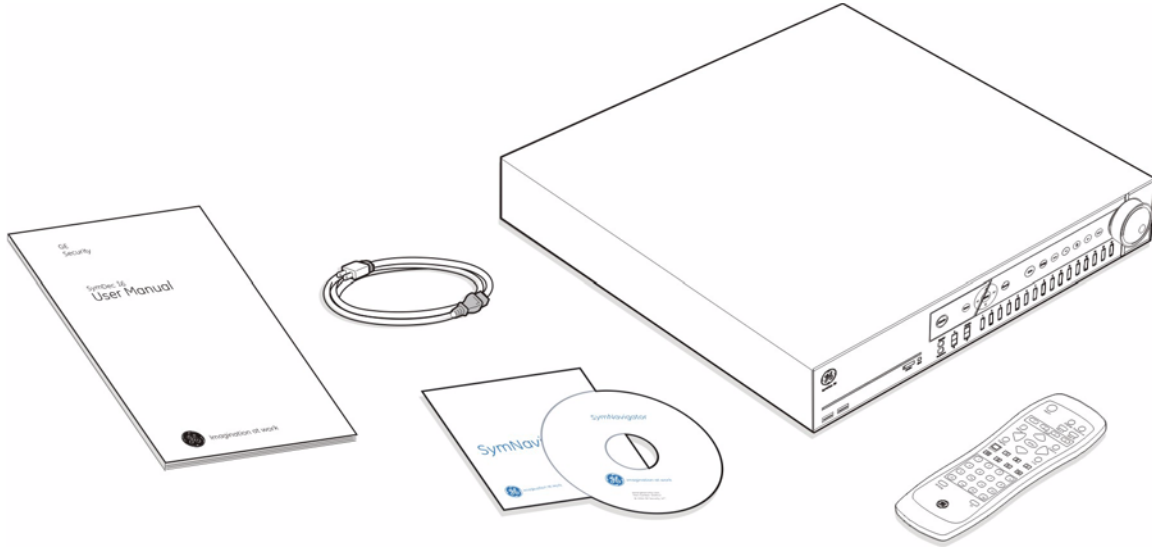

Product contents

The SymDec 16 plus 4 system consists of the following:

- The SymDec 16 plus 4 unit
- 1 power cord (US)
- SymDec 16 plus 4 user manual
- SymNav software CD
- 6 terminating connectors (attached to back panel)
- IR remote controller

Inspect the package and contents for visible damage. If any components are damaged or missing, do not use the unit; contact the supplier immediately. If you need to return the unit, you must ship it in the original box.

Installation Environment

Power: Ensure that the site's AC power is stable and within the rated voltage of the external power supply. If the site's AC power is likely to have spikes or power dips, use power line conditioning or an Uninterruptable Power Supply (UPS).

Ventilation: Install the unit in a well-ventilated area. Take note of the locations of the cooling vents in the unit's enclosure, and ensure that they are not obstructed.

Temperature: Observe the unit's ambient temperature specifications when choosing a location space. Extremes of heat or cold beyond the specified operating temperature limits may cause the unit to fail. Do not install the unit on top of other hot equipment.

Moisture: Do not expose the unit to rain or moisture. Moisture can damage the internal components. Do not install this unit near sources of water.

Hard drives: Hard drives can be damaged if not handled properly. Do not set heavy objects on top of this unit. Take all necessary precautions to protect this unit from transient voltages and do not place this unit near magnetic devices. Do not move this unit while in operation. Wait at least 30 seconds after removing power before moving the unit or removing the hard drive.

Associated Equipment

Associated equipment you might need:

- Analog cameras (16).
- SymVeo IP Cameras (4).
- Analog or DVI monitor to view VGA video.
- Alarm input devices: Pressure sensors, motion detectors, etc.
- Alarm output devices: Buzzers, Sirens, Flashing Lights, etc.
- A PC connected by Ethernet.
- Microphones (4) with amplification.
- Speakers to hear audio.
- Symnet encoder/decoder to receive or send video.

For instructions regarding the connection of the associated security equipment in your system, please consult the instruction manual of the associated equipment.

Rack Mounting

The SymDec 16 plus 4 is easily rack-mountable with the purchase of the model number **SymDec16 plus 4-RK** rack mount kit. To install, do the following:

1. Attach the 2 small rack ears as shown with the supplied 10-32 x 1/2" screws.
2. Attach the 2 large rear support brackets to the rear rails with 10-32 x 3/4" screws.
1. Attach the SymSafe to the front rails with 10-32 x 3/4" screws.

Figure 2. Rack mount installation

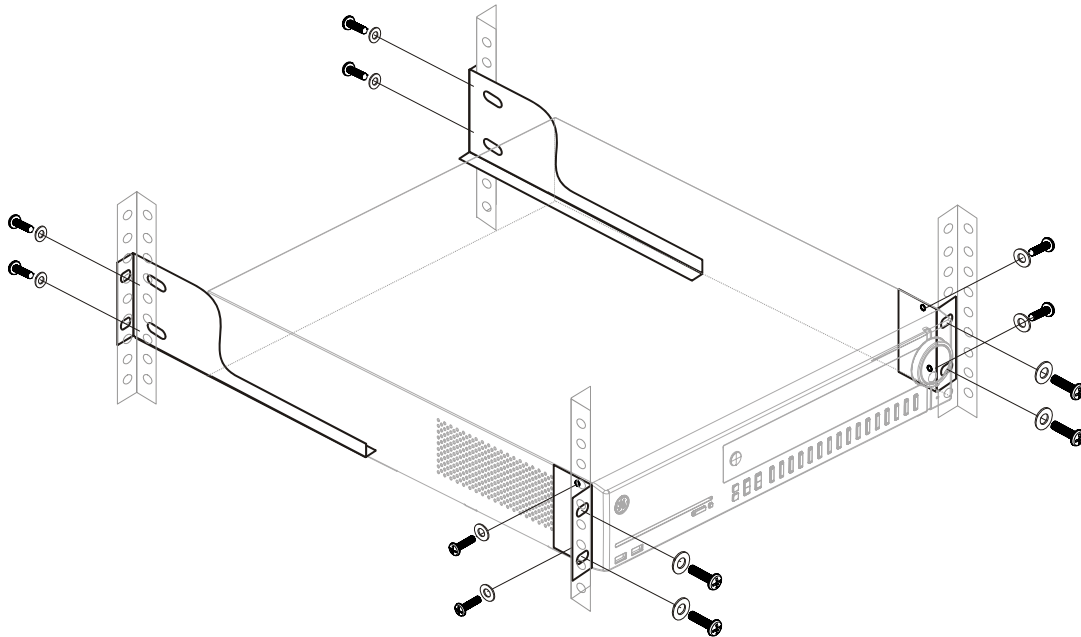

CAUTION

Do not rackmount the SymDec16 plus 4 without the rear rails installed. Failure to install the rear rails can damage the SymDec 16 plus 4.

Elevated Operating Ambient - If installed in a closed or multi-unit rack assembly, the operating ambient temperature of the rack environment may be greater than room ambient. Therefore, consideration should be given to installing the equipment in an environment compatible with the maximum ambient temperature (40?) specified by the manufacturer.

Reduced Air Flow - Installation of the equipment in a rack should be such that the amount of air flow required for safe operation of the equipment is not compromised.

Mechanical Loading - Mounting of the equipment in the rack should be such that a hazardous condition is not achieved due to uneven mechanical loading.

Circuit Overloading - Consideration should be given to the connection of the equipment to the supply circuit and the effect that overloading of the circuits might have on overcurrent protection and supply wiring. Appropriate consideration of equipment nameplate ratings should be used when addressing this concern.

Reliable Earthing - Reliable earthing of rack-mounted equipment should be maintained. Particular attention should be given to supply connections other than direct connections to the branch circuit (e.g. use of power strips).

Passwords

Passwords are provided to limit access to the SymDec 16 plus 4, WebServer, and the SymNav software. It is recommended that the default password be changed after installation is complete. As a security measure, store the password in the administrator's secured files or in a limited access area.

Table 1. Default password

Password name	Program	Changeable by user	Default password
user 1	On Screen Display (OSD)	Yes, through the Main menu	111111
user 2	On Screen Display (OSD)	Yes, through the Main menu	222222
user 3	On Screen Display (OSD)	Yes, through the Main menu	333333

Default IP Addresses

These settings provide access and control of the SymDec 16 plus 4 over an IP network. The default Ethernet setting is *DHCP*. To access these IP addresses the Ethernet setting must be changed to *Static*.

Table 2. Default IP addresses

Address name	Changeable by user	Default user
IP Address	Yes	192.168.1.82
Subnet Mask	Yes	255.255.255.0
Gateway Address	Yes	192.168.1.1

These IP addresses should be changed before you connect to your IP network. Contact your network administrator to obtain your network specific addresses.

Chapter 2 Connections and Controls

This chapter deals with the various physical features, connectors, controls, and indicators of the SymDec 16 plus 4.

In this chapter:

- Front Panel Controls and Features* 10
- Back Panel Connections* 12
 - Camera Inputs* 12
 - Audio Inputs and Output* 13
 - Alarm Inputs* 13
 - USB connectors* 13
 - Ethernet Port* 14
 - RS-485/RS-422 I/O connectors* 14
 - RS232 Port* 15
 - VGA connector* 15
 - DVI connector* 16
 - Monitor A/B composite output* 16
 - Alarm out connector* 16
 - Power Connector* 17
- Connection Diagrams* 18
- The Remote Controller* 20

Front Panel Controls and Features

Figure 3. SymDec 16 plus 4 front panel

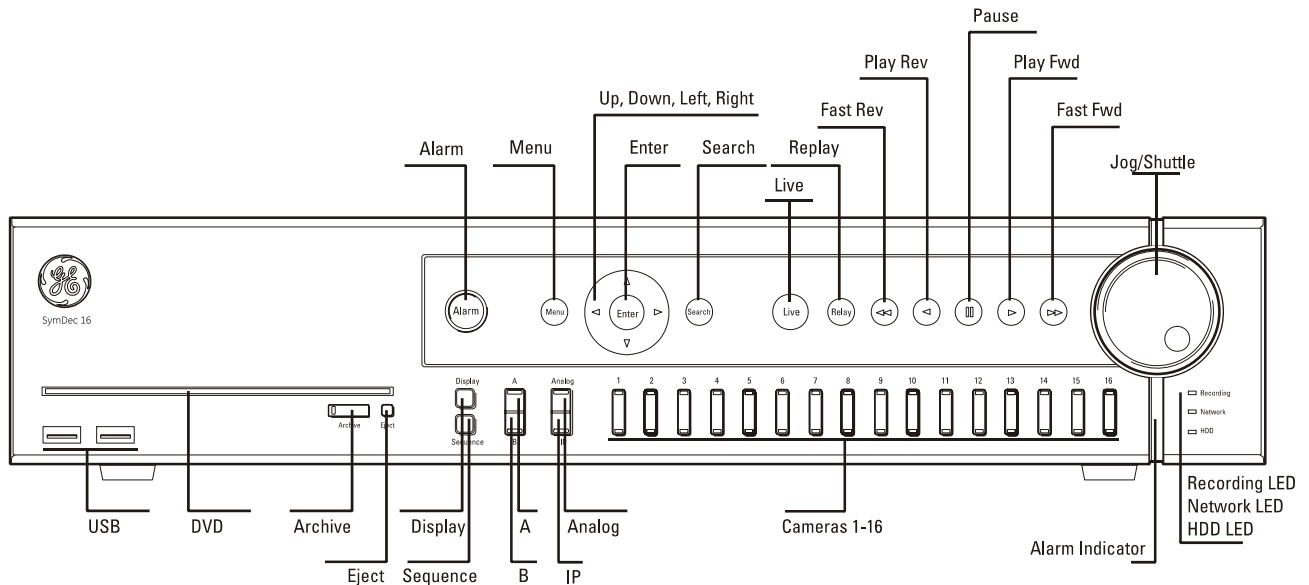

Table 3. Front panel controls

Control	Use
Alarm button	LED glows red to indicate an alarm condition. Push to silence current alarm.
Menu button	Touch to enter OSD and enter <i>Setup mode</i> . In <i>Setup mode</i> , touch to discard changes and return to the next highest level menu or exits OSD.
Arrow buttons	Use to navigate menus.
Enter button	In <i>Setup mode</i> toggles in and out of editable fields. In <i>Playback mode</i> starts <i>Cameo mode</i> .
Search button	Touch to display the <i>Search</i> and <i>Disk Analysis</i> screen.
Live button	Touch to stop all video playback and return to showing live video.
Replay button	Touch to jump the play marker back x seconds. Configured in Front Panel on page 52.
Fast reverse button	Touch to play video in reverse. Touch again to increase speed.
Play reverse button	Touch to play video in reverse at 1X speed.
Pause button	Touch to freeze all video at the current play marker.
Play forward button	Touch to play video at 1X speed.
Fast forward button	Touch to play video. Touch again to increase speed.
Jog/Shuttle	During playback, rotate the shuttle (the outer dial) to increase playing speed. Use the jog to pause and view video frame by frame.

Control	Use
Alarm Indicator	Mimics the most severe status level of the alarm LED's (Camera, Recording, Network, or HDD LED) Red (flash bright). If any alarm LED is flashing red, or Red (solid bright). If any alarm LED is solid red, or Green (solid bright). If all status is okay on all alarm LED's. Off. Power off.
USB connectors	Connects to compatible USB devices such as a flashdrive.
DVD recorder	Use to archive video. See caution below.
Archive button	Push to initiate <i>Archive mode</i> .
Eject button	Push to eject DVD-R from drive.
Display button	Push to cycle through available multiscreen options for monitor A.
Sequence button	Push to start <i>Sequence mode</i> . Default sequence is analog cameras 1-16, then IP cameras 1-4.
Monitor A/B buttons	Controls which monitor will be affected by the analog/IP camera controls.
Analog/IP button	Controls which camera is selected when the camera buttons are pressed.
Camera buttons	Push to display the selected camera in fullscreen. In <i>Setup mode</i> used to input numerical data.
Camera LED (Analog 1-16 and IP 1-4)	Green (solid bright): Connected and working properly, awake mode. Green (solid dim): Connected and working properly, stealth mode. Red (flashing): Alarm detected, not acknowledged, or in Videoloss. Red (solid): Alarm detected, acknowledged. Off, camera is disabled.
Recording LED	Green (solid bright): Recording properly, awake mode. Green (solid dim): Recording properly, stealth mode. Red (flashing): Recording failure, not acknowledged. Red (solid): Recording failure, acknowledged.
Network LED	Green (solid bright): Connected and working properly, awake mode. Green (solid dim): Connected and working properly, stealth mode. Red (flashing): Connection failure alarm, not acknowledged. Red (solid): Connection failure alarm, acknowledged.
HDD LED	Green (solid bright): Working properly, awake mode. Green (solid dim): Working properly, stealth mode. Red (flashing): Disk failure alarm, not acknowledged. Red (solid): Disk failure alarm, acknowledged.

**CAUTION**

Do not use CD/DVD's with paper labels attached to the surface of the CD/DVD. The label's surface may become damaged and cause the CD/DVD media to become stuck inside the DVD recorder.

Back Panel Connections

Figure 4. SymDec 16 plus 4 back panel

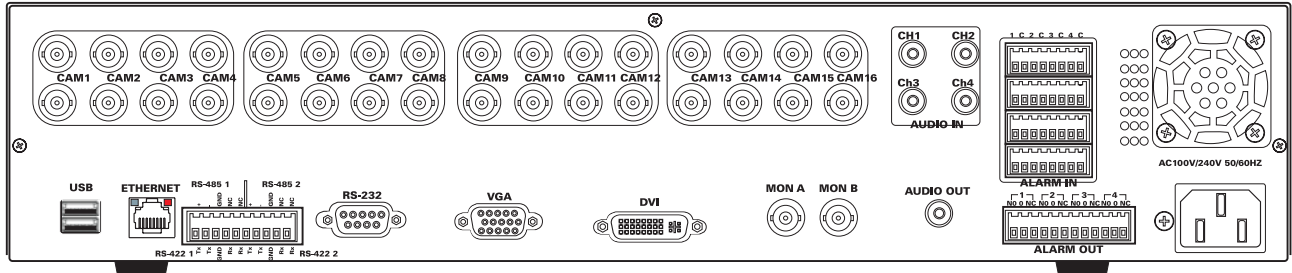

Table 4. Back panel connectors

Connector	Use
Video In/Out	Camera Inputs 1-16, BNC connector, looping, and auto-terminating.
Audio inputs	4 channels of line-level audio inputs with RCA connectors.
Alarm inputs	16 channels of alarm inputs.
USB connectors	2 USB connectors for flashdrives or a USB compatible mouse.
Ethernet port	For connecting to a Network.
Serial inputs (RS-485/RS-422)	2 RS-422 or 2 RS-485 serial ports.
RS-232 connector	1 RS-232 serial port.
VGA connector	For connecting to a standard VGA monitor.
DVI connector	For connecting to a Digital Video Interface monitor.
Monitor A/B	Composite video output for monitors A and B.
Audio out	Line-level audio output with a RCA connector.
Alarm out connector	4-channel alarm outputs.
Power connector	For connecting the power cord.

Camera Inputs

There are two BNC jacks for each camera. Either jack can receive a camera signal. The signal is looped (directly connected to the other jack), making the camera signal available to other equipment.

The camera input connectors are auto terminating. This means that the input signal will automatically be terminated with 75-Ohms unless a 2nd cable is connected to the 2nd BNC connector of the same camera input. Make sure there is 75-Ohm termination at the end of the video line if the signal is looped through the SymDec 16 plus 4.

Time base correction is performed during digital capture. As a result, cameras do not require synchronization.

Cable	75-Ohm coaxial
Connectors	BNC
Auto terminating	Yes
Passive looping	Yes

Audio Inputs and Output

The unit is equipped with 4 audio inputs and 1 audio output. Both the audio output and the audio inputs are line-level. The 4 audio inputs are associated with the first 4 cameras.

Audio input	RCA jack, 315 mV, 40k Ohms. Unbalanced
Audio out	RCA jack, 315mV, 600 Ohms. Unbalanced

Note: Line-level audio requires amplification.

Alarm Inputs

Four 8-pin connectors on the back panel provide the connections for the alarm inputs. Connect the wires to the 4 terminating connectors provided with the SymDec 16 plus 4. See the table below for a description of the pinouts.

Table 5.

Alarm IN connector							
Pin	Signal	Pin	Signal	Pin	Signal	Pin	Signal
1	Alarm Input 1 N/Open	5	Alarm Input 5 N/Open	9	Alarm Input 9 N/Open	13	Alarm Input 13 N/Open
C	Alarm Input 1 Common	C	Alarm Input 5 Common	C	Alarm Input 9 Common	C	Alarm Input 13 Common
2	Alarm Input 2 N/Open	6	Alarm Input 6 N/Open	10	Alarm Input 10 N/Open	14	Alarm Input 14 N/Open
C	Alarm Input 2 Common	C	Alarm Input 6 Common	C	Alarm Input 10 Common	C	Alarm Input 14 Common
3	Alarm Input 3 N/Open	7	Alarm Input 7 N/Open	11	Alarm Input 11 N/Open	15	Alarm Input 15 N/Open
C	Alarm Input 3 Common	C	Alarm Input 7 Common	C	Alarm Input 11 Common	C	Alarm Input 15 Common
4	Alarm Input 4 N/Open	8	Alarm Input 8 N/Open	12	Alarm Input 12 N/Open	16	Alarm Input 16 N/Open
C	Alarm Input 4 Common	C	Alarm Input 8 Common	C	Alarm Input 12 Common	C	Alarm Input 16 Common

Note: Do not attempt to wire any accessories directly to the I/O connector on the back panel. These connections require dry contact (voltage free) closure to activate.

USB connectors

Industry compatible USB connectors for use with flashdrives for updating the SymDec 16 plus 4.

Ethernet Port

The cable connection configuration for the ethernet port depends on your network configuration:

- For a SymDec 16 plus 4 that connects directly to a hub, use a straight through connection.
- For a SymDec 16 plus 4 that connects directly to a PC, use a cross-over connection.

Consult with your network administrator or IS professional for the specific type of configuration. See [The Network menu](#) on page 59 for information about configuring the Ethernet settings in the menu system

Ethernet	10/100/1000 Base-T, auto sensing
Wire type	Cat 5e/6
Connector type	RJ-45
Maximum cable length	328 feet/100 meters
Minimum cable length	6 feet/1.8 meters
Hub wiring configuration	Straight through
PC wiring configuration	Cross-over

RS-485/RS-422 I/O connectors

These (2) serial I/O ports can be configured as either RS-485 or RS-422 and are used for Pan, Tilt, Zoom control of PTZ cameras. Use [Serial Communications](#) on page 78 to configure these ports. See tables 6 and 7 for the serial pinouts for each configuration.

Table 6. RS-485 1 and 2 port pinouts

Port type	Pin	Description
RS-485 (1)	1	+
	2	-
	3	Ground
	4	Not connected
	5	Not connected
RS-485 (2)	6	+
	7	-
	8	Ground
	9	Not connected
	10	Not connected

Table 7. RS-422 1 and 2 port pinouts

Port type	Pin	Description
RS-422 (1)	1	TX+
	2	TX-
	3	Ground
	4	RX+
	5	RX-
RS-422 (2)	6	TX+
	7	TX-
	8	Ground
	9	RX+
	10	RX-

RS232 Port

The RS232 port is provided for use with GE's ProBridge text insertion interface modules in conjunction with compatible POS (point of sale) and ATM (automated teller machine) systems. Use *Serial Communications* on page 78 to configure this port.

Table 8. RS232 port pinouts

Pin	Description
1	DCD
2	RX
3	TX
4	DTR
5	Grounded
6	Not connected
7	RTS
8	CTS
9	Not connected

VGA connector

The 15-pin VGA connector is provided for connection to a standard VGA monitor for monitoring video.

DVI connector

The DVI (Digital Video Interface) is provided for connection to high-speed, high-resolution digital displays.

Monitor A/B composite output

When connecting directly from the SymDec 16 plus 4 to the monitor, select the 75-Ohm impedance setting on the monitor. If an additional device is connected to the monitor's looping output, set the termination of the additional device as 75-Ohm, and set the termination of the monitor as Hi-Z (High Impedance).

Cable	75-Ohm
Connectors	BNC

Alarm out connector

The 4 Alarm out connectors are provided for connections to audio/visual alarm notification devices such as sirens and warning lights.

Table 9. Alarm out port pinouts

Alarm out number	Pin	Description
Alarm out 1	1	NO (Normally open)
	2	C (Common)
	3	NC (Normally closed)
Alarm out 2	1	NO (Normally open)
	2	C (Common)
	3	NC (Normally closed)
Alarm out 3	1	NO (Normally open)
	2	C (Common)
	3	NC (Normally closed)
Alarm out 4	1	NO (Normally open)
	2	C (Common)
	3	NC (Normally closed)

Power Connector

Plug the power cord into the power cord connector and then into a properly rated wall socket. Once power is applied to the unit, it will begin its power-up procedure. The unit will begin by displaying the software version on Monitor-A, then the unit will begin recording automatically.

Table 10. Power supply rating

Power supply	
Voltage	100-240 VAC 50-60 Hz, auto-ranging
Amps	5

Connection Diagrams

Use the figures on the following pages a visual guide to connect the various peripherals to the SymDec 16 plus 4.

Figure 5. Rear panel connection diagram

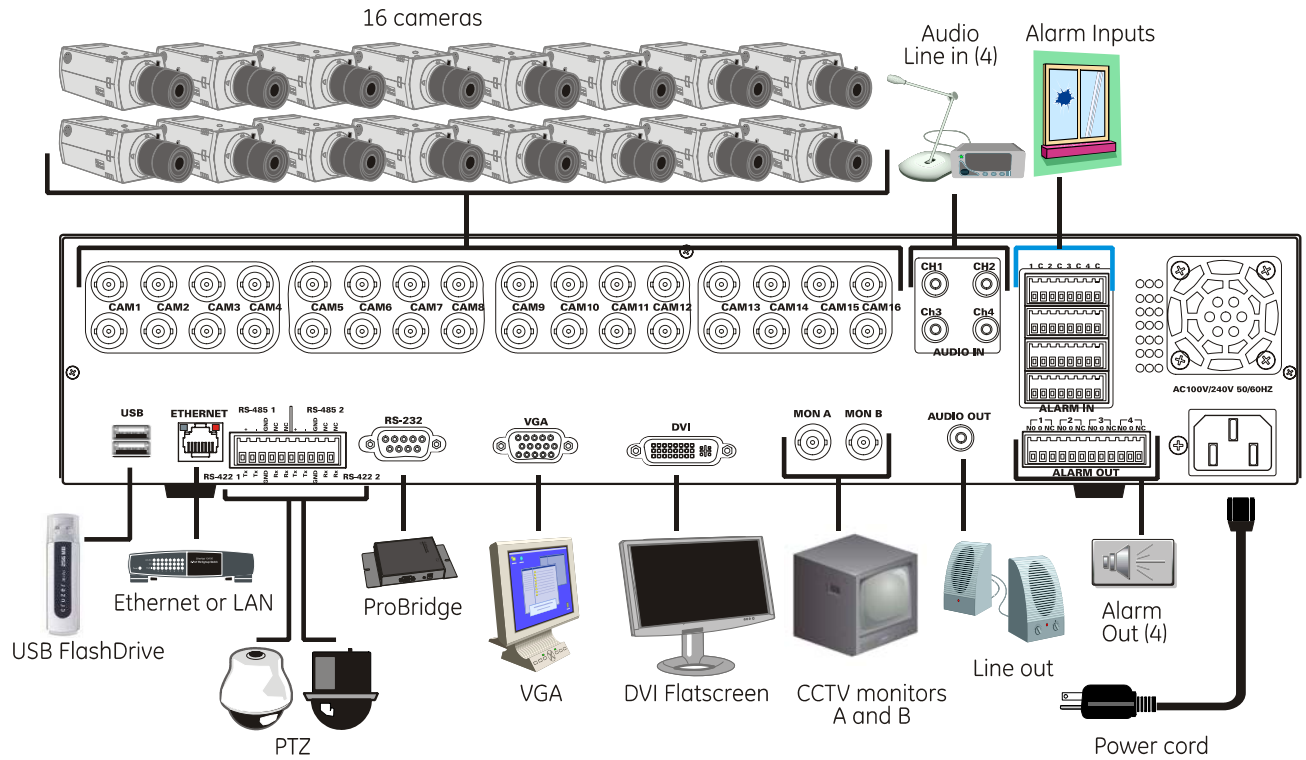
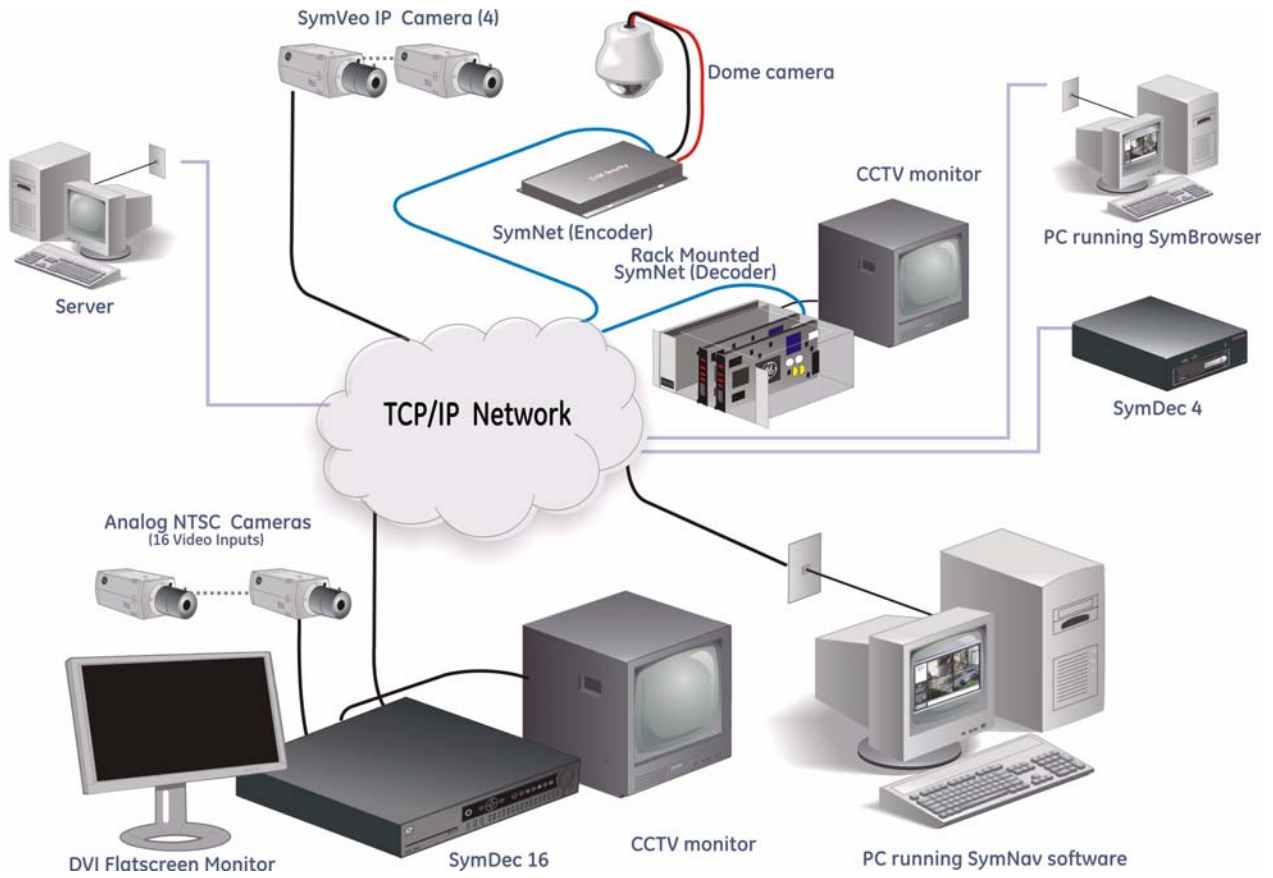

Figure 6. Sample network diagram



The Remote Controller

The SymDec 16 plus 4 is supplied with an Infra Red (IR) remote control unit. It can be used to operate many of the main functions of the SymDec 16 plus 4 and can be programmed to work with up to 4 SymDec 16 plus 4's.

Figure 7. The remote control unit

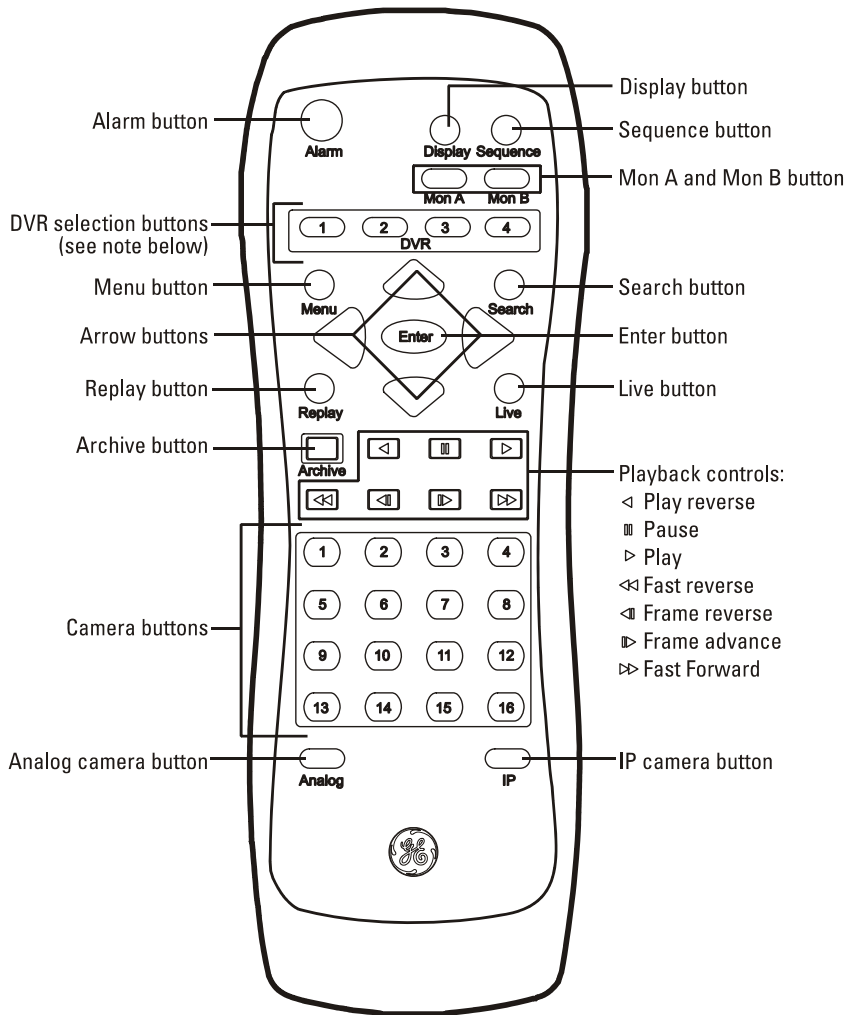

Note: The remote controller can be programmed with a unique address (1-4) so that the controller will only be able to communicate with unit's with that address. See [Front Panel](#) on page 52 to program.

Chapter 3 Basic Operations

This chapter provides procedures for performing some of the basic operations of the SymDec 16 plus 4 from logging in to creating an archive disk.

In this chapter:

- Front Panel Controls* 22
- Operations* 24
 - How to Log In.* 24
 - How to change the display for Monitor A and Monitor B* 24
 - How to change the display to a full-screen analog view* 24
 - How to change the display to a full-screen IP view* 24
 - How to view multiscreen displays* 24
 - How to change the display presets* 25
 - How to enter Cameo mode* 25
 - How to display Sequencing* 25
 - How to return to the default sequence list* 25
 - How to enter Playback mode* 25
 - How to Search using Disk Analysis* 26
 - How to Search using the Filters Screen* 26
 - How to archive from the Search screen* 26
 - How to use the Archive screen* 27
 - How to setup and stream an IP camera to a SymDec 16* 27
 - How to setup a KTD-405 keypad to work with the SymDec 16* 28
 - How to set the IP camera option to a keypad button* 28
 - KTD-405 keypad mapping to SymDec 16 front panel* 29

Front Panel Controls

The front panel is shown here as quick reference for the procedures that follow.

Figure 8. SymDec 16 plus 4 front panel

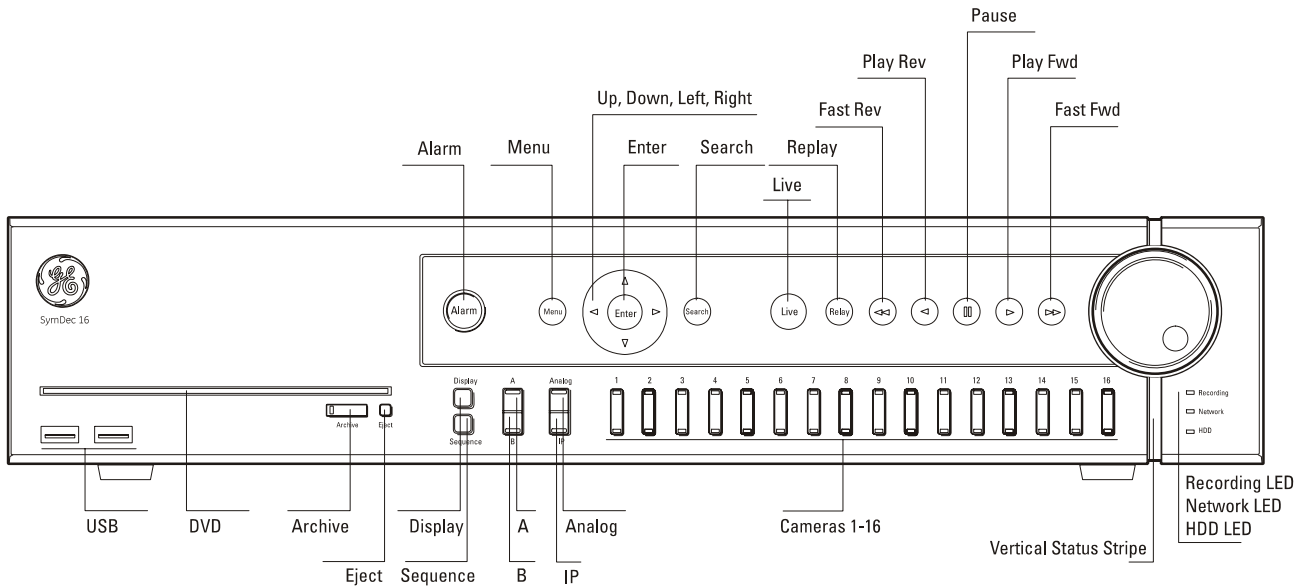

Table 11. Front panel controls

Control	Use
Alarm button	LED glows red to indicate an alarm condition. Push to silence current alarm.
Menu button	Touch to enter OSD and enter <i>Setup mode</i> . In <i>Setup mode</i> , touch to discard changes and return to the next highest level menu or exits OSD.
Arrow buttons	Use to navigate menus.
Enter button	In <i>Setup mode</i> toggles in and out of editable fields. In <i>Playback mode</i> starts <i>Cameo mode</i> .
Search button	Touch to display the <i>Search</i> and <i>Disk Analysis</i> screen.
Live button	Touch to stop all video playback and return to showing live video.
Replay button	Touch to jump the play marker back x seconds. Configured in Front Panel on page 52.
Fast reverse button	Touch to play video in reverse. Touch again to increase speed.
Play reverse button	Touch to play video in reverse at 1X speed.
Pause button	Touch to freeze all video at the current play marker.
Play forward button	Touch to play video at 1X speed.
Fast forward button	Touch to play video. Touch again to increase speed.
Jog/Shuttle	During playback, rotate the shuttle (the outer dial) to increase playing speed. Use the jog to pause and view video frame by frame.

Control	Use
Vertical status stripe	Mimics the most severe status level of the alarm LED's (Camera, Recording, Network, or HDD LED) Red (flash bright). If any alarm LED is flashing red, or Red (solid bright). If any alarm LED is solid red, or Green (solid bright). If all status is okay on all alarm LED's. Off. Power off.
USB connectors	Connects to compatible USB devices such as a flashdrive.
DVD recorder	Use to archive video. See caution below.
Archive button	Push to initiate <i>Archive mode</i> .
Eject button	Push to eject DVD-R from drive.
Display button	Push to cycle through available multiscreen options for monitor A.
Sequence button	Push to start <i>Sequence mode</i> . Default sequence is analog cameras 1-16, then IP cameras 1-4.
Monitor A/B buttons	Controls which monitor will be affected by the analog/IP camera controls.
Analog/IP button	Controls which camera is selected when the camera buttons are pressed.
Camera buttons	Push to display the selected camera in fullscreen. In <i>Setup mode</i> used to input numerical data.
Recording LED	Green (solid bright): Recording properly, awake mode. Green (solid dim): Recording properly, stealth mode. Red (flashing): Recording failure, not acknowledged. Red (solid): Recording failure, acknowledged.
Network LED	Green (solid bright): Connected and working properly, awake mode. Green (solid dim): Connected and working properly, stealth mode. Red (flashing): Connection failure alarm, not acknowledged. Red (solid): Connection failure alarm, acknowledged.
HDD LED	Green (solid bright): Working properly, awake mode. Green (solid dim): Working properly, stealth mode. Red (flashing): Disk failure alarm, not acknowledged. Red (solid): Disk failure alarm, acknowledged.

**CAUTION**

Do not use DVD's with paper labels attached to the surface of the DVD. The label's surface may become damaged and cause the DVD media to become stuck inside the DVD recorder.

Operations

The following sections provide step-by-step instructions on some of the SymDec 16 plus 4's most common operations.

How to Log In

To log in to the Symdec 16 plus 4 do the following:

1. Press the *Menu* button on the front panel or remote control.
2. Use the *arrow* buttons to select your user account and press *Enter* to finish.
3. Input your PIN code, using the *camera number* buttons on the front panel or remote camera buttons. Select *Done* when finished.
4. You should now be logged in. Depending on your permissions, you can now access *Search*, *Archive*, the front panel controls and the OSD menus.

How to change the display for Monitor A and Monitor B

1. To control live and playback functions and access the menus, press the *Mon A* button.
2. To change the display of live video on the secondary display, press the *Mon B* button.

How to change the display to a full-screen analog view

1. Press the *Analog* button if the LED is not lit to enable the analog camera buttons.
2. Press the *camera number* (1-16) of the camera you wish to view full-screen.

How to change the display to a full-screen IP view

1. Press the *IP* button if the LED is not lit to enable the IP camera buttons.
2. Press the *camera number* (1-4) of the IP camera you wish to view full-screen.

How to view multiscreen displays

1. Select the display to view the multiscreens by pressing the *Mon A or B* button.
2. Press the *Display* button to toggle through the available multiscreen displays.
3. Display sequence for Mon A is full-screen, 4-up, 9-up, 16-up. Display sequence for Mon B is full-screen and 4-up.

How to change the display presets

1. Press and hold the *Display* button on the front panel.
2. The *Display Preset* screen will appear.
3. Select from the ten displayed options by pressing the corresponding camera button. The selected screen replaces the factory default display.

How to enter Cameo mode

A cameo is defined as any cell in a multiscreen display.

1. From any multiscreen display, use the arrow buttons to move the selection box to a selected display and press *enter*.
2. Press the *IP* or *Analog* button followed by a *camera number* button.

How to display Sequencing

The sequencing feature allows a camera to be displayed briefly on-screen, before advancing to the next camera in the sequence list. The default sequence list displays each camera in numerical order.

From Full Screen

1. Press any *camera number* to enter fullscreen mode.
2. Press the *Sequence* button to begin automatic sequencing.

From Multiscreen

1. While in a multiscreen display, use the *arrow* buttons to move the selection box to the camera you wish to display sequencing and press *enter*.
2. Press the *Sequence* button to begin automatic sequencing in that cameo.

How to return to the default sequence list

1. Press and hold the *Display* button to reset all screens to the default.
2. Select number nine to return to the default screen list.

How to enter Playback mode

From Multiscreen

1. In multiscreen mode, move the selection box to the desired camera and press *enter*.
2. Press *play*. The selected camera is now in playback.

To return to Live mode

1. With the selection box on the playback display cameo press *enter*.
2. Press the *Live* button. The selected display is now in live mode.

How to Search using Disk Analysis

1. Press the *Search* button to bring up the *Disk Analysis* and *Filters* menu.
2. Press *enter* to use the Disk Analysis screen.
3. Press the *left* and *right* arrow buttons to move the time cursor backward or forward through the available video.
4. Press the *Up* arrow button to zoom out and the *down* arrow button to zoom in.
5. Use *arrow* buttons to find the video you want to view, then press *enter* to preview the video. Press *Play* to begin playback.
6. Press a *camera* button to view the playback fullscreen.

How to Search using the Filters Screen

1. Press the *Search* button to bring up the *Disk Analysis* and *Filters* menu.
2. Press the *up/down* arrow buttons to select the desired filter. You can filter by *Date and Time*, *Cameras or Motion*, *Alarms/Events*, or *Text and Time of Day*.
3. Press *enter* to change the filter mode and settings.
4. Change the filter as desired and Press *Menu* button to return to the top level menu.
5. When you have set all the filters, Select *Search Now* and Press *enter*. The *Thumbnail Previews* screen will appear.
6. From the *Thumbnail Previews* screen select the video you which to review and press *enter* to begin previewing the video in playback.

How to archive from the Search screen

1. With the *Thumbnail Previews* screen displayed, use the playback controls to move the video to the desired *Start Time* for the archive and select *Set Start* then Press *enter*.
2. Now advance the video using the playback controls to the desired *Stop Time* for the archive and select *Set Stop* and Press *enter*.
3. Select *Archive* and press *enter*. You are now in the *Archive Screen*.
4. Either insert a blank optical disc in the DVD Burner slot or plug in a USB storage device into the front panel USB connector.
5. Press *enter* to change the media and Press *enter* to confirm the selection.
6. Press the *down* arrow to select the *Archive Name*. Press *enter* and use the on-screen keyboard to change the name of the file to be exported. Select *Done* and press *enter* when finished.

7. Press the *down* arrow to select the *Include Player* checkbox. Check to include the GE SymPlayer, or uncheck if you have previously installed the player or will play the video in SymNav.
8. Press the *down* arrow and use the *Camera List* block to select the cameras within the *Start and Stop* window to be exported. Be sure the *Archive Size* is smaller than the archive media. You may need to change the *Start* and *Stop* by returning to the *Thumbnail Previews* screen or select fewer camera channels to make it fit.
9. Press the *down* arrow until you *Select Archive Now*; Press *enter* to begin the export. You may safely remove the media once the *Archive Complete* message is shown.

How to use the Archive screen

1. Press the *Archive* button on the front panel. The *Archive Screen* will appear.
2. Insert a blank optical disc in the DVD Burner slot or plug in a USB storage device into the front panel USB connector.
3. Press *enter* to change the media and Press *enter* to confirm the selection.
4. Press the *down* arrow to select the *Archive Name*. Press *enter* and use the on-screen keyboard to change the name of the file to be exported. Select *Done* and press *enter* when finished.
5. Press the *down* arrow to select the archive length. The *Archive Stop Time* was set when you pressed the *Archive* button. Press *enter* and adjust the length to change the *Start Time*. Press *enter* to confirm the length.
6. Press the *down* arrow to select the *Include Player* checkbox. Check to include the GE SymPlayer, or uncheck if you have previously installed the player or will play the video in SymNav.
7. Press the *down* arrow and use the *Camera List* block to select the cameras within the *Start and Stop* window to be exported. Be sure the *Archive Size* is smaller than the archive media. You may need to change the *Start* and *Stop* by selecting fewer camera channels to make it fit.
8. Press the *down* arrow until you *Select Archive Now*; Press *enter* to begin the export. You may safely remove the media once the *Archive Complete* message is shown.

How to setup and stream an IP camera to a SymDec 16

1. Set the *IP address* and the *Streaming/Multicast address* on the IP camera. This is done through the camera's setup menu.
2. Select the *Camera menu* from the *Main menu* on the SymDec 16.
3. Select the *IP camera number* that you are going to setup.
4. Input the camera's **IP address** in the *Source Address* field in the *Recording menu*.
5. Press the *Menu button* twice to return to the *Main menu*.
6. Select the *Network menu*.
7. Select the *IP advanced menu*.
8. Enter the camera's **Streaming/Multicast address** into the *Multicast* field. This address always starts with the number 230. (230.xxx.xxx.xxx)

Example

- The DVR *IP address* is 168.125.115.010
- The Camera *IP address* is 168.125.115.025 (both in the camera itself and SymDec 16 camera menu)
- The *Multicast/Streaming* address on both the camera and SymDec 16 should be 230.125.115.025
- If you have a second IP camera: The Camera *IP Address* could be 168.125.115.026 and the *Multicast/Streaming* address would still be 230.125.115.025

How to setup a KTD-405 keypad to work with the SymDec 16

To setup and connect a KTD-405 keypad and a Symdec 16 follow the steps below. You will need to refer to the KTD-405 user manual (part number 1036547D).

1. Connect a pair of wires from the KTD-405 I/O box to the SymDec 16 Bus 1/485 port.
 - KTD-405 I/O box pin RS485 (A) to SymDec 16 Serial I/O Bus 1/485 pin 1 (+).
 - KTD-405 I/O box pin RS485 (B) to SymDec 16 Serial I/O Bus 1/485 pin 2 (-).
2. Verify the serial communication settings on Bus 1 of the Symdec 16;
 - a. Go to the *System/Serial Communication* Bus 1 menu and verify the following:
 - Bus 1 Type: RS-0485
 - Protocol: Kalatel
 - Baud Rate: 9600
 - DVR Addr: 1
3. Enter *Zone mode* operation on the KTD405 keypad. Please refer to your KTD-405 manual for more detailed information. Access the KTD-405 zone mode by doing:
 - a. Hold down the *Enter* key.
 - b. Enter programming code: 5-7-9-seq.
 - c. Change operating mode from *Digiplex* to *Zone* mode by the joystick up/down.
 - d. Press the *Fast Forward* button.
 - e. Hold down the *Seq* button to exit the menu.
 - f. You should be in *Zone* mode.
 - g. Press the *Zone* button, then the number *1*. This will initiate a connection between the SymDec 16 and the KTD-405 keypad.

How to set the IP camera option to a keypad button

The KTD-405 and SymDec 16 should be connected and operational.

1. Hold down the *Enter* button on the KTD-405.
2. Enter programming code: 1-4-7-6-seq.
3. Press the *fast forward* button until you get to the *Program Soft Keys* option.
4. Press the + button.

5. When it says *Press key to program*, press the magnifying glass icon.
6. Move the joystick up until you reach the *ALT* option.
7. Press the *Enter* and the + button to confirm the change.
8. Press the *Seq* button to exit programming mode.
9. You should now be able to select the IP camera by pressing the magnifying glass icon.

KTD-405 keypad mapping to SymDec 16 front panel

Figure 9. KTD-405 panel buttons

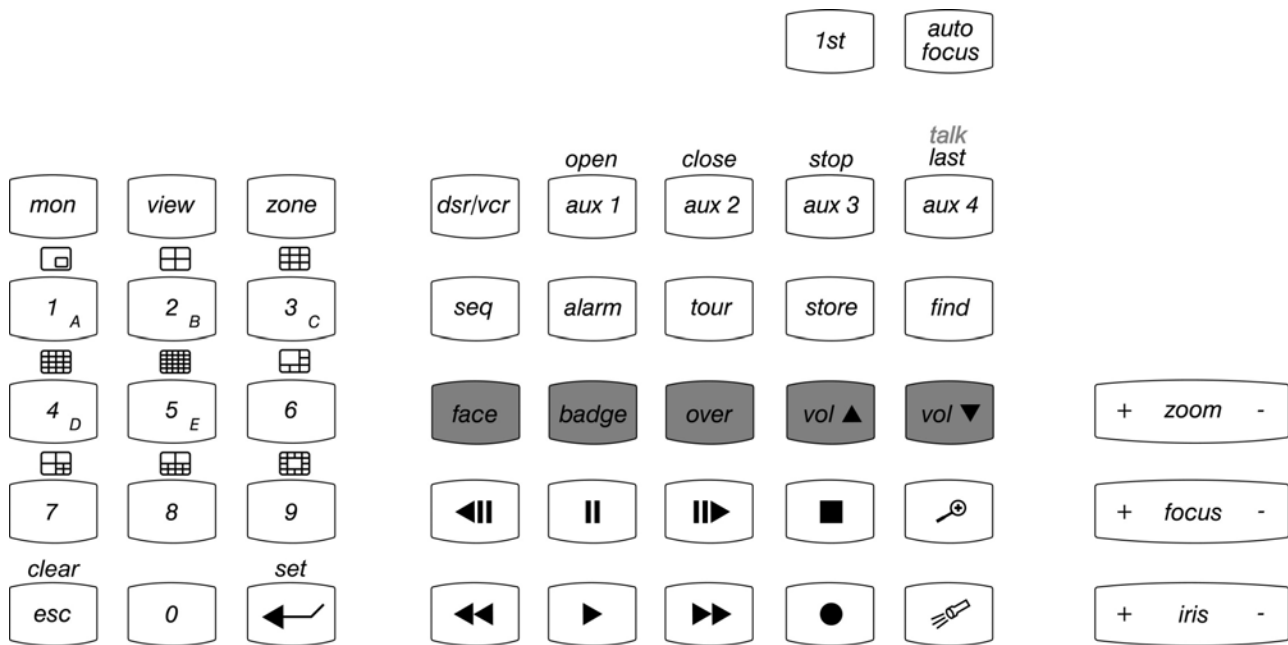





Table 12. KTD-405 to SymDec 16 front panel mapping

KTD-405 Keypad	SymDec 16 front panel function
●	Replay button: In playback mode, touch to jump the play marker back x seconds.
▶	Play forward button: plays video at 1x speed.
■	Live button: Stops video playback and returns to showing live video.
	Pause button: Freezes all video at the current play marker.
▶▶	Fast forward button: In playback mode, increases play speed.
◀◀	Fast reverse button: In playback mode, plays video in reverse. Touch again to increase speed.
▶	Play forward button: Plays video forward at 1x speed.
◀	Play reverse button: Plays video in reverse at 1x speed.
🔍	Can be configured to display selected IP camera.

Table 12. KTD-405 to SymDec 16 front panel mapping

KTD-405 Keypad	SymDec 16 front panel function
	Search button: Displays the Search and Disk Analysis screens.
Joystick	In setup mode, scrolls up, down, left, right in menus. In play or pause modes, rotate clockwise or counter clockwise to jog video forward or reverse.
	In setup mode, emulates the Enter button. Toggles in and out of editable fields.
esc	Emulates the Menu button. Push to enter OSD mode or to discard changes in menus.
Alarm	Emulates the Alarm button. Push to acknowledge all alarms.
View	Emulates the Display button. Push to cycle through available multiscreens. Use with the 2-5 number buttons.
Seq	Emulates the Sequence button.
Mon	Use with 0 and 1 number buttons to select Monitor A or Monitor B.
Zone	Zone +  + 1-16 (number buttons) +  emulates Camera buttons.

Chapter 4 Programming the SymDec 16 plus 4

This chapter provides an in-depth review of the On Screen Display (OSD). The OSD is used to program how the SymDec 16 plus 4 operates from setting up the password levels to the record rates of the cameras.

In this chapter:

- Log In* 32
- Cameras menu* 35
- The Schedule menu* 47
- The Users menu* 57
- The Network menu* 59
- The Display menu* 69
- The System menu* 70
- The Info menu* 83

Log In

To program your SymDec 16 plus 4 you must first setup a user and create a password or PIN. Make sure, at a minimum, you have attached a monitor to view the OSD and applied power to the SymDec 16 plus 4. To setup a user, press the *Menu button* on the front panel. The initial *Log In* screen will appear.

Note: A maximum of 24 users can be logged in at the same time.

Figure 10. The Log In screen

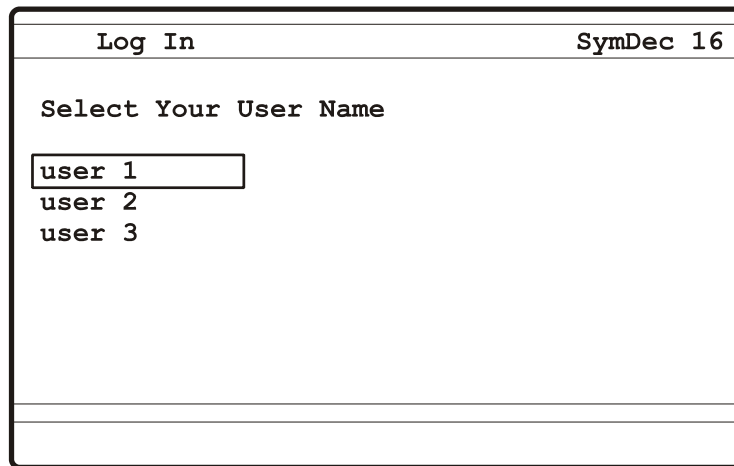

Use the arrow buttons to navigate, select a **user** and press the *Enter button*. The *Enter Your Pin* screen will appear.

Figure 11. The Enter Your Pin screen

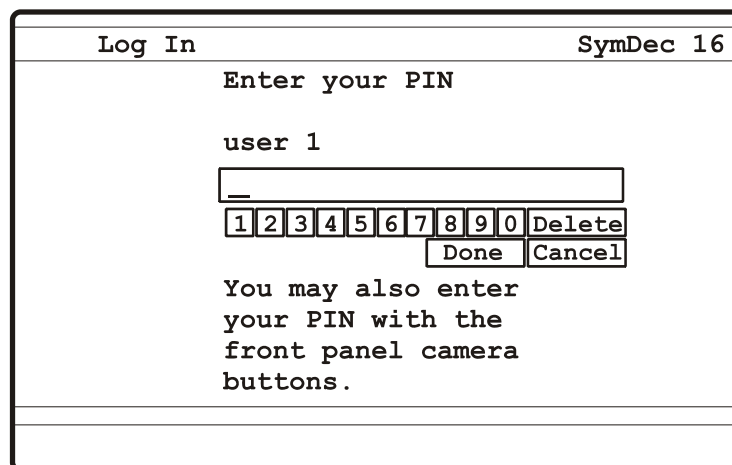

Enter the default password by using the *Arrow* and *Enter* buttons. You can also use the camera buttons to enter the password.

Table 13. Default passwords

Password name	Default password (PIN)	Default Access level
user 1	111111	Administrator
user 2	222222	Manager
user 3	333333	Operator

When completed, navigate to the *Done* button and press *Enter*. The *Main OSD menu* will appear.

Main Menu

The Main menu contains the following sub-menus:

- Cameras
- Schedule
- Alarms
- Users
- Network
- Display
- System
- Info

Figure 12. The Main menu

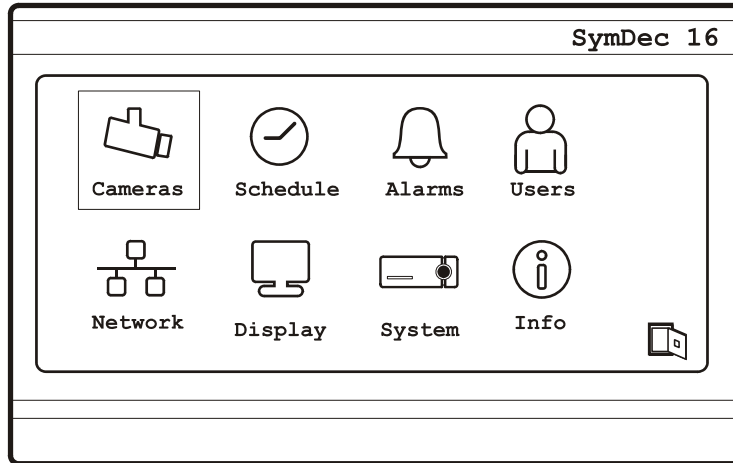

Note: GE recommends that after you have completed your initial Log In you should setup up your users, passwords, and access levels for security reasons. See [The Users menu](#) on page 57 for complete information.

Cameras menu

Highlight the *Cameras* icon on the Main menu and press the *enter* button. The *Cameras* menu will appear.

Figure 13. The Cameras menu

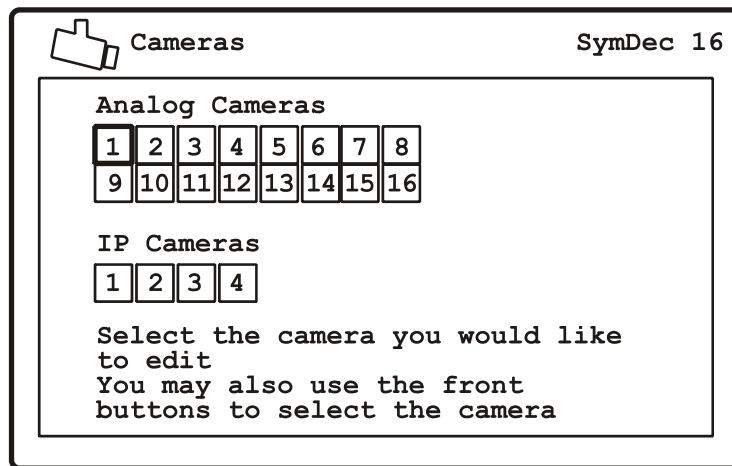

Select the camera type (analog or IP) and camera number which you wish to configure and press the *Enter* button. The analog camera or IP camera edit menu will display.

Note: The camera number can be selected by using the arrow buttons on the front panel, the camera number buttons on the front panel, or the camera number buttons on the remote controller.

Analog Camera menu

The Analog Camera menu contains the following options and their settings:

- Recording
- Rates
- Alarm Input
- Motion
- Camera Title
- Adjust Video
- Copy Setting

Recording Menu

Use this menu to select the recording input, record quality, resolution, and record mode. You can also use this menu to enable or disable the covert, low latency, and audio features of the camera selected.

Figure 14. The Camera/Recording menu

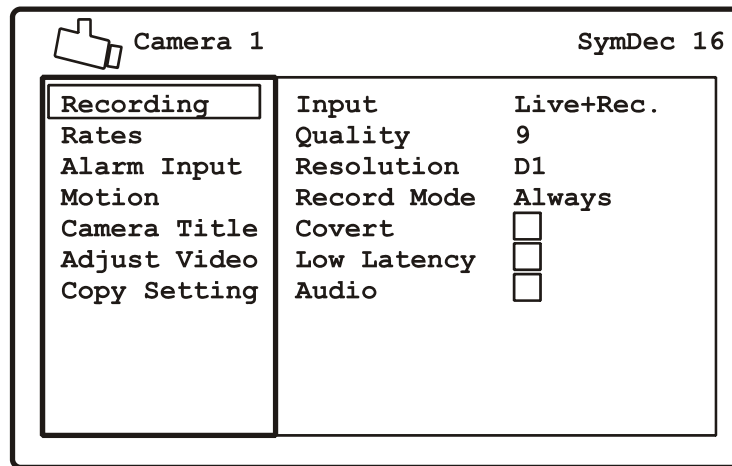

Table 14. Cameras/Recording options

Menu Setting	Options
Record Input	Live, Disable, Live + Record
Record Quality	1 (low quality) to 9 (high quality)
Resolution	D1 (704x480), 2CIF (704x240), CIF (352x240)
Record Mode	Always, Alarm only, Event + Alarm
Covert	Enable or disable. Covert means the camera is recording but the display is turned off. After selecting covert, you must exit and logout of the DVR menu before the changes will take effect.
Low latency	Enable or disable. Enabling low latency increases the response time but lowers the quality. Normally used with PTZ cameras.
Audio	Enable or disable audio recording on this camera. The audio option is only for Cameras 1-4.

Duration Rates

Use this menu to select the record rates under normal condition (timelapse rate) and when an alarm or event occurs. You can also set the pre and post recording times for both event and alarm conditions.

Figure 15. The Camera/Duration Rates menu

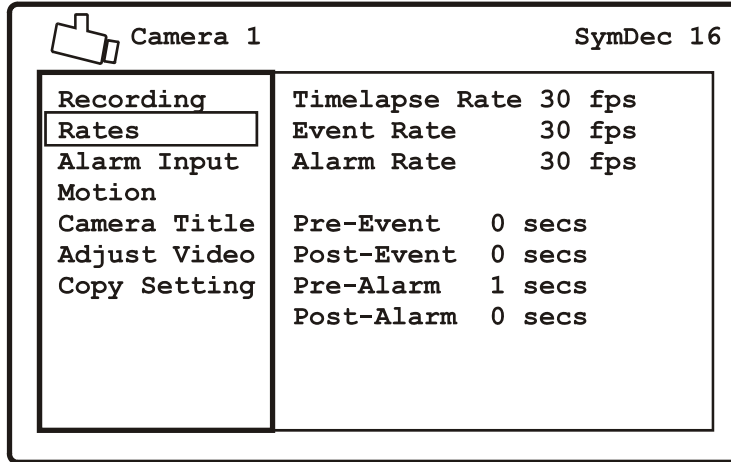

Table 15. The Cameras/Rates options

Menu Setting	Options
Timelapse Rate	2, 5, 10, 15, 30 fps (frames per second)
Event Rate	2, 5, 10, 15, 30 fps
Alarm Rate	2, 5, 10, 15, 30 fps
Pre-Event	0-99 seconds
Post-Event	0-99 seconds
Pre-Alarm	0-99 seconds
Post-Event	0-99 seconds

Note: The Pre-Event and Pre-Alarm settings are dependant on the *Resolution, Quality, and Alarm Rate* settings from the *Recording* menu.

Alarm Input

Use this menu to connect 1 or more alarm inputs to the currently selected camera. Press the enter button to enter the edit mode. Select from alarm inputs 1-16 and IP alarms 1-4. You can also enable or disable video loss, fullscreen alarm, and indicator here. When video loss is enabled it will be reported as an alarm on the selected camera.

Figure 16. The Cameras/Alarm Inputs menu

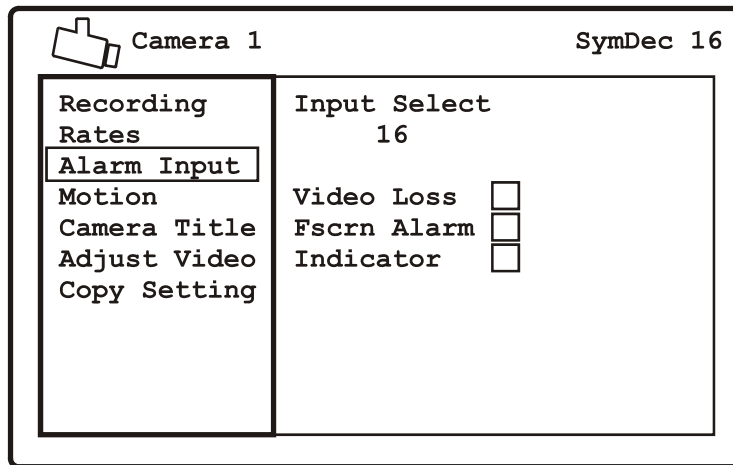

Motion Detection

Use this menu to set up the various parameters associated with motion detection such as the trigger, sensitivity, target size, rejection threshold, and where on the video to monitor for motion.

Figure 17. The Cameras/Motion Detection menu

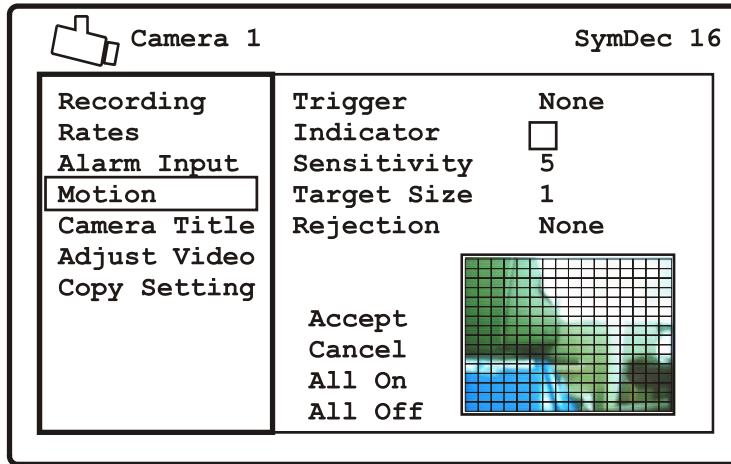

Table 16. The Cameras/motion detection options

Menu setting	Options
Trigger	None, Event, Alarm 1-16, IP Alarm 1-4
Indicator	Check to enable/disable the displaying of the M indicator.
Sensitivity	1 (least) to 9 (most)
Target size	0-256. This setting is the minimum number of zones (from the 16 x 16 grid) that must be activated simultaneously before it is considered to be valid motion.
Rejection	None, low, medium, high. These settings are based on the number of simultaneously triggered zones and the persistence of motion in a scene. The Low setting is the most sensitive to motion. The Medium setting will filter out most false alarm situations due to sudden luminance changes over the whole scene (clouds passing over). The High setting will filter out sudden luminance changes as well as spurious motion events that do not persist for a number of frames (a bird flying past the lens).
Motion edit screen	<p>Press the enter button to move into edit mode. Use the arrow buttons to select or deselect the areas on the grid to set for motion detection. Press the enter button to cycle through the selection cursors:</p> <ul style="list-style-type: none"> • White outline: Use to position cursor for selection or deselection of a previously selected area • Blue: Selects areas on the grid for motion detection • Red: Cursor changes to red when parameter thresholds are achieved <p>Press the menu button to go to the commands in the edit window. Select from:</p> <ul style="list-style-type: none"> • Accept • Cancel • All On • All Off

Camera Title

Use this menu to change the camera title. Press the enter button to access the on-screen keypad to edit the title. Use the arrow buttons to navigate and the enter button to select the various alphanumeric characters available.

Figure 18. The Camera/Camera Title menu

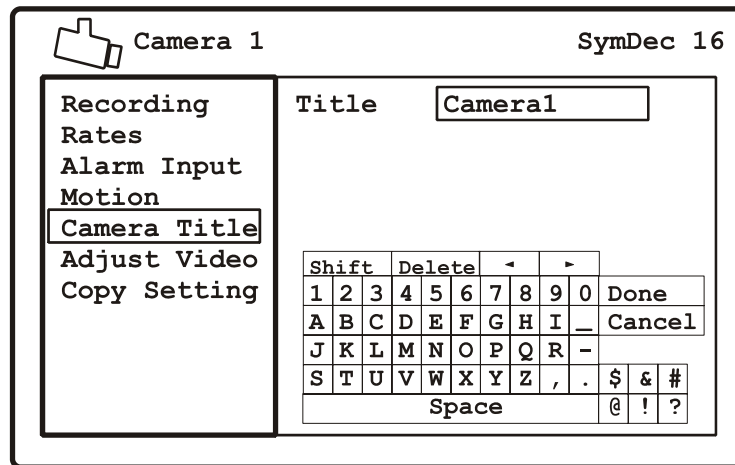

Adjust Video

Use this menu to adjust the selected cameras video image. You can also enable or disable the Automatic Gain Control (AGC) here.

Figure 19. The Camera/Adjust Video menu

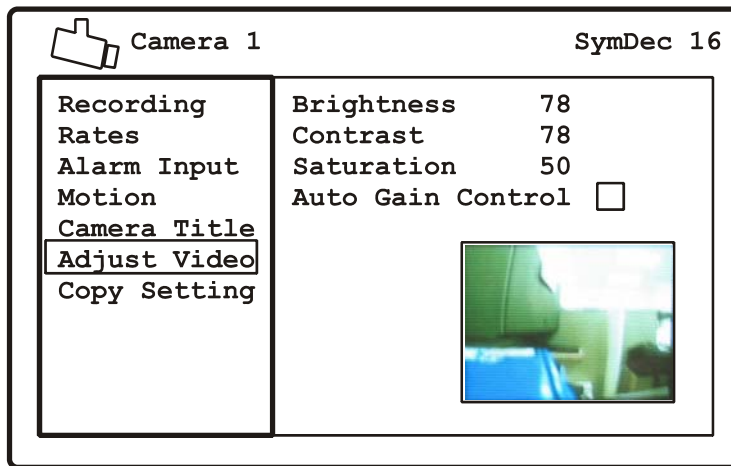

Table 17. The Camera/Adjust Video settings

Menu setting	Options
Brightness	0-99
Contrast	0-99
Saturation	0-99
Automatic Gain Control	Enable/disable

Copy Settings

Use this menu to quickly copy one camera's settings to the other available cameras. Press enter to access the edit area. Select the cameras to copy the selected camera's parameters. Navigate to the *Copy Now* command to execute.

Note: The *Copy Setting* command copies **all** the selected camera's configurable settings.

Figure 20. The Camera/Copy Settings menu

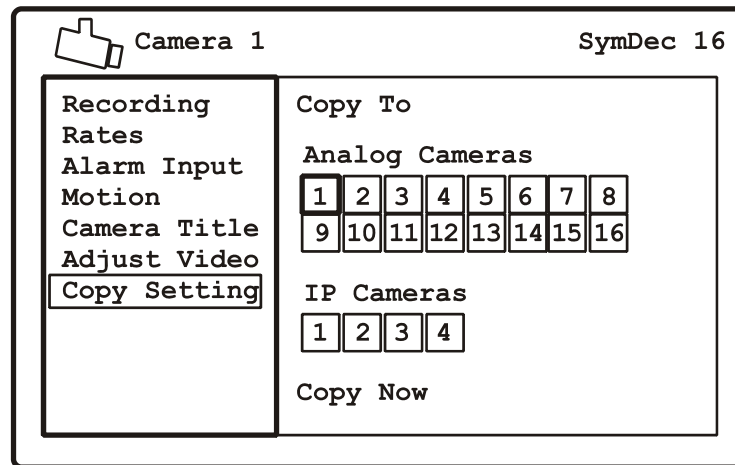

IP Camera menu

The IP Camera menu contains the following options and their settings:

- Recording
- Rates
- Alarm Input
- Camera Title
- Copy Setting

Recording

Use this menu to select the camera type, recording input, IP address, and record mode of the IP camera or video stream. You can also use this menu to enable or disable the covert feature of the IP camera selected. These options vary according to the camera type selected.

Figure 21. The IP Camera/Recording menu

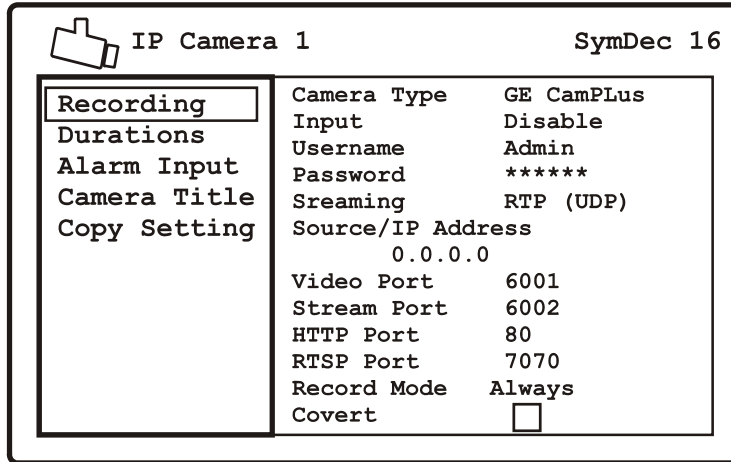

Table 18. Cameras/Recording options

Menu Setting	Options
Camera Type	SymProtocol, ACTi 2.0, GE CamPlus
Record Input	Live, Disable, Live + Record
Username	Press enter to launch virtual keypad to input username (not available for SymProtocol)
Password	Press enter to launch virtual keypad to input password (not available for SymProtocol)
Streaming	TCP Only, RTP (UDP) (not available for SymProtocol)
Source/IP Address	IP address of selected camera
Video Port	6001 (not available for SymProtocol)
Stream Port	6002 (not available for SymProtocol)
HTTP Port	80 (not available for SymProtocol)
RTSP Port	7070 (not available for SymProtocol)
Record Mode	Always, Alarm only, Event + Alarm
Covert	Enable or disable. Covert means the camera is recording but the display is turned off.

Duration Rates

Use this menu to set the pre and post recording times for both event and alarm conditions.

Figure 22. The IP Camera/Duration Rates menu

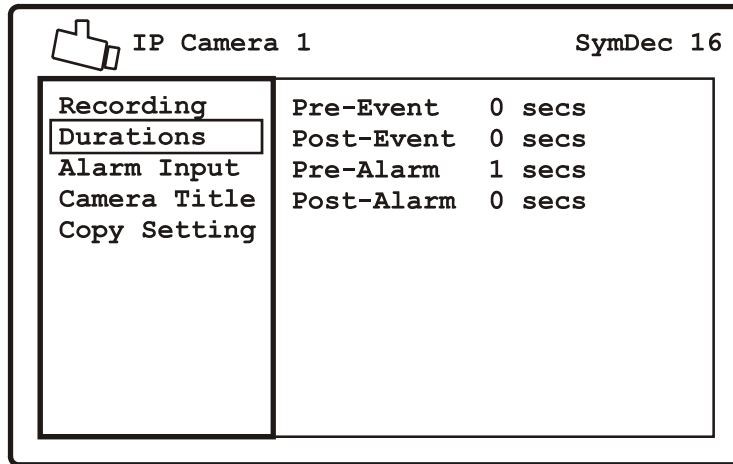

Table 19. IP Cameras/Duration Rates

Menu Setting	Options
Pre-Event	0-99 seconds
Post-Event	0-99 seconds
Pre-Alarm	0-99 seconds
Post-Event	0-99 seconds

Note: These settings will vary depending on the Time/Lapse settings.

IP Camera Alarm Input

Use this menu to connect 1 or more alarm inputs to the currently selected IP camera. Press the enter button to enter the edit mode. Select from alarm inputs 1-16 and IP rearms 1-4. You can also enable or disable video loss, fullscreen alarm, and indicator here. When video loss is enabled it will be reported as an alarm on the selected IP camera.

Figure 23. The IP Camera/Alarm Input menu

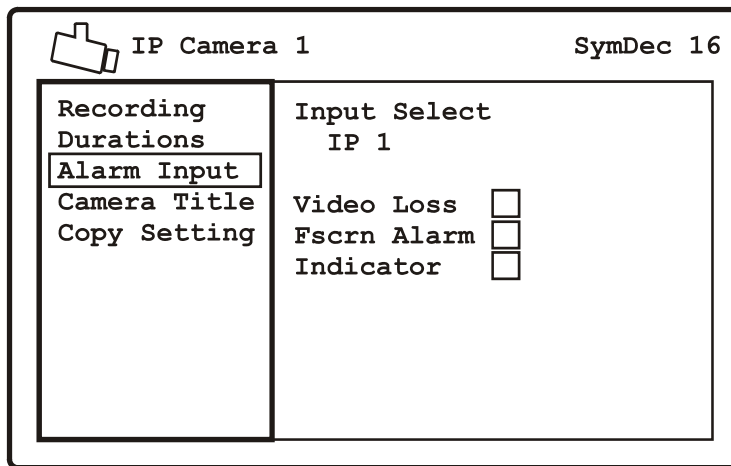

Camera Title

Use this menu to change the camera title. Press the enter button to access the on-screen keypad to edit the title. Use the arrow buttons to navigate and the enter button to select the various alphanumeric characters available.

Figure 24. The IP Camera/Camera Title menu

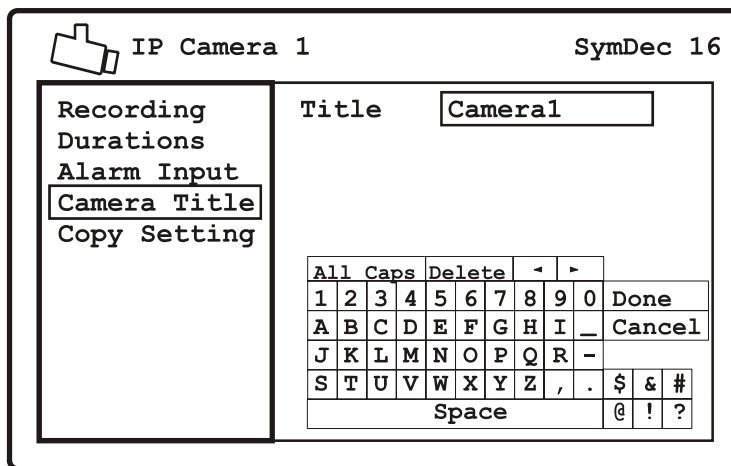

Copy Settings

Use this menu to quickly copy one camera's settings to other available cameras. Press *enter* to access the edit area. Select the cameras to copy the selected camera's parameters. Navigate to the *Copy Now* command to execute.

Note: The *Copy Setting* command copies **all** the selected camera's configurable settings.

Figure 25. The IP Camera/Copy Settings menu

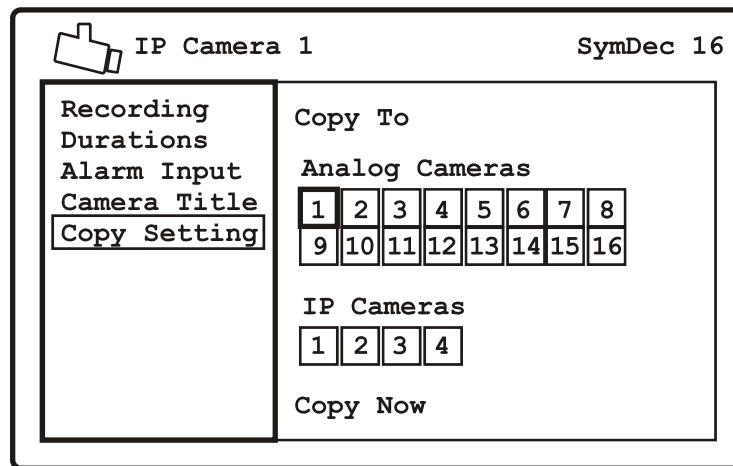

The Schedule menu

Use this menu to create and schedule macros. A macro is a recorded sequence of keystrokes. Highlight the *Schedule* icon and press the *enter* button. The *Schedule* menu will appear.

Figure 26. The Schedule menu

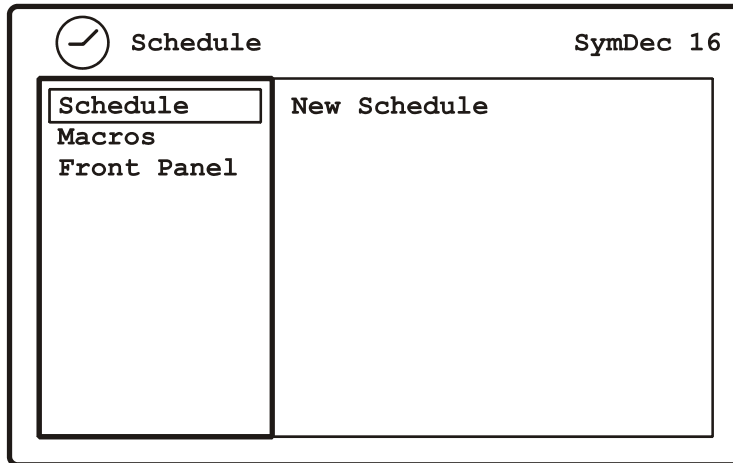

The Schedule menu contains the following options and their settings:

- New Schedule: Schedule start times for macros.
- Macros: Create and select macros.
- Front Panel: Assign a camera number button to a macro for front panel execution.

New Schedule

Use this menu to create or edit a schedule for a specific macro. Press enter to access the edit area.

Figure 27. The Schedule/New Schedule menu

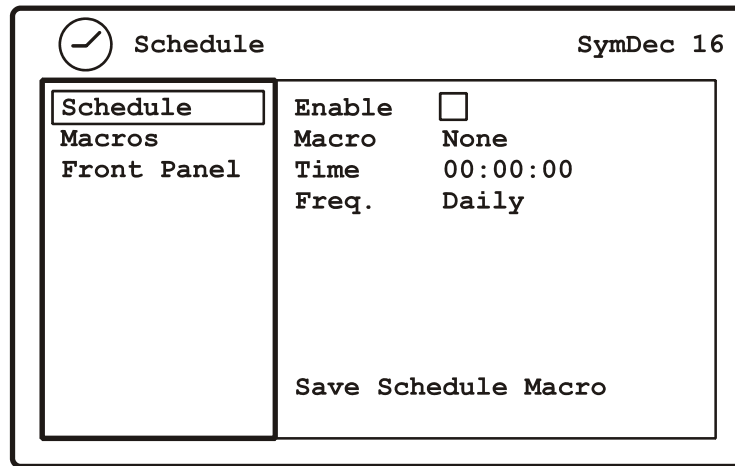

Table 20. The Schedule/New Schedule options

Menu Setting	Options
Enable	Enable or disable
Macros	None or Names of defined macros
Time	Define hour and minute of execution
Frequency	Daily, multiple days, specific date

Macros

Use this menu to create a new macro or edit a previously created macro. Press enter to access the edit area.

Figure 28. The Schedule/Macros Menu

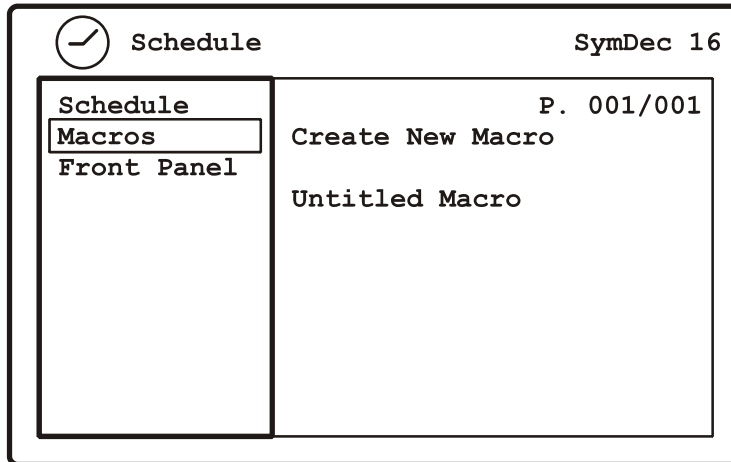

Create new Macro

Use this menu to select various predefined macro features and record your macro.

Figure 29. The Schedule/Macro/Create New Macro menu

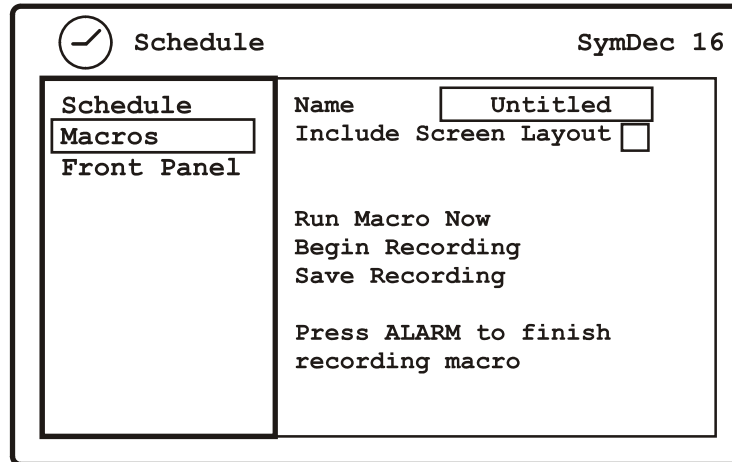

Table 21. The Schedule/Create New Macro menu options

Menu setting	Options
Name	Press enter to edit and use the keypad to assign a name to the macro
Include Screen Layout	Check to enable/disable.
Run Macro Now	Select and press enter to run the macro immediately
Begin Recording	Select and press enter to start recording keystroke. Press the Alarm button to stop recording.
Save Recording	Select and press enter to save the macro

Edit Macro

Use this menu to edit previously created macros.

Figure 30. The Schedule/Macro/Edit Macro menu

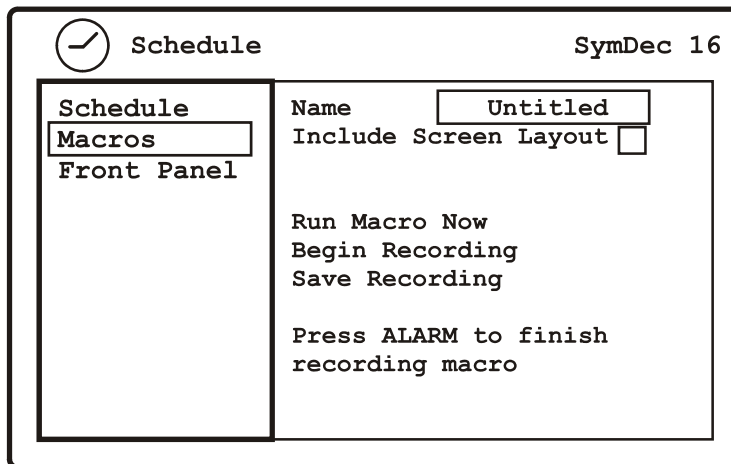

Table 22. The Schedule/Macros/Edit Macro menu options

Menu setting	Options
Name	Press enter to edit and use the keypad to change the name of the macro
Include Screen Layout	Check to enable/disable.
Run Macro Now	Select and press enter to run the macro immediately
Begin Recording	Select and press enter to start recording keystroke. Press the Alarm button to stop recording.
Delete Macro	Select and press enter to delete the current macro

Front Panel

Use this menu to assign a camera button (1-16) to a created Macro. Once assigned hold down the camera button (2 sec.) to launch the macro.

Figure 31. The Schedule/Front Panel menu

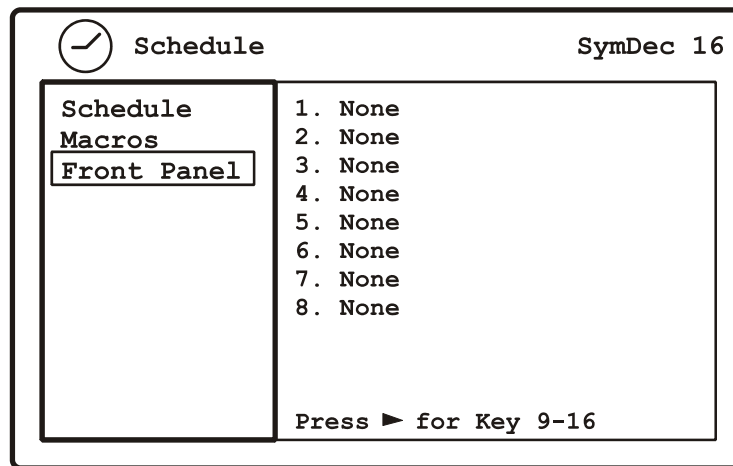

How to schedule a macro

As an example, let's say that we want to turn camera 1 off at 7 p.m. and back on at 7 a.m. This requires that you:

1. Create a macro to turn camera 1 off and name it **Camera 1 Off**.
 - a. From the *Macros* screen press *enter* to move to edit mode.
 - b. Select *Create New Macro* and press *enter*.
 - c. In the *Name* field press *enter*.
 - d. Use the on-screen keypad to enter *Camera 1 Off*. Press *Done* when finished.
 - e. Navigate to *Begin Recording* and press *enter*.
 - f. Select *Camera* and press *enter*. Select camera 1.
 - g. Press *enter*, select *Input* and press *enter*. Select *Disable* and press *enter*.
 - h. Press the *Alarm* button to finish recording the macro.
 - i. Select *Save Macro* and press *enter*.
2. Create a macro to turn camera 1 on and name it **Camera 1 On**.
 - a. From the *Macros* screen press *enter* to move to edit mode.
 - b. Select *Create New Macro* and press *enter*.
 - c. In the *Name* field press *enter*.

- d. Use the on-screen keypad to enter *Camera 1 On Press Done* when finished.
 - e. Navigate to *Begin Recording* and press *enter*.
 - f. Select *Camera* and press *enter*. Select camera 1.
 - g. Press *enter*, select *Input* and press *enter*. Select *Live + Rec.* and press *enter*.
 - h. Press the *Alarm* button to finish recording the macro.
 - i. Select *Save Macro* and press *enter*.
3. Schedule macro **Camera 1 Off**.
- a. Navigate to the *Schedule* menu and press *enter* on *New Schedule* to move to edit mode.
 - b. Press *enter* to enable the schedule.
 - c. Move the cursor to the *Macro* command and press *enter*.
 - d. Select *Camera 1 Off* and press *enter*.
 - e. Move the cursor to the *Time* command and press *enter*.
 - f. Use the *arrow buttons* to select 7 p.m. and press *enter*
 - g. Move the cursor to the *Save Schedule Macros* command and press *enter*.
4. Schedule macro **Camera 1 On**.
- a. Navigate to the *Schedule* menu and press *enter* on *New Schedule* to move to edit mode.
 - b. Press *enter* to enable the schedule.
 - c. Move the cursor to the *Macro* command and press *enter*.
 - d. Select *Camera 1 On* and press *enter*.
 - e. Move the cursor to the *Time* command and press *enter*.
 - f. Use the *arrow buttons* to select 7 a.m. and press *enter*
 - g. Move the cursor to the *Save Schedule Macros* command and press *enter*.

The macros **Camera 1 Off** and **Camera 1 On** are now scheduled to run at their selected times.

The Alarms menu

Highlight the *Alarm* icon and press the *enter button*. The *Alarm* menu will appear. The Alarm menu contains the following menus:

- Notification
- Silent Alarm
- Alarm Inputs and Outputs

Notification

Use this menu to assign the listed incidences to a specific output (Buzzer, Email, TCP/IP, Alarm Output 1-4).

Figure 32. The Alarms/Notification menu

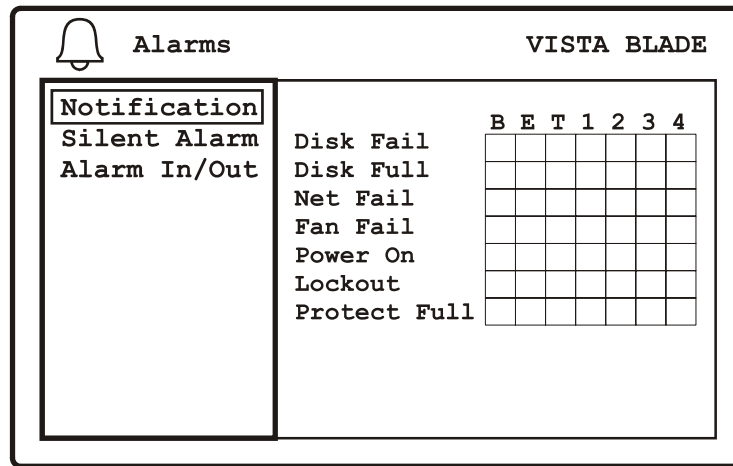

Table 23. Notification descriptions

Notification	Description
Disk Fail	When a hard disk failure is detected.
Disk Full	When a hard disk is at capacity.
Net Fail	When a network failure is detected.
Fan Fail	When a fan failure is detected.
Power On	On shutdown a flag is set to indicate successful shutdown. If no flag is detected at bootup, power failure is assumed.
Lockout	Three repeated login failures locks the unit for 30 minutes and sends a notification.

Silent Alarm

Use this menu to enable or disable an alarm (buzzer) that has been linked to Camera or Silent Alarms.

Figure 33. The Alarms/Silent Alarm menu

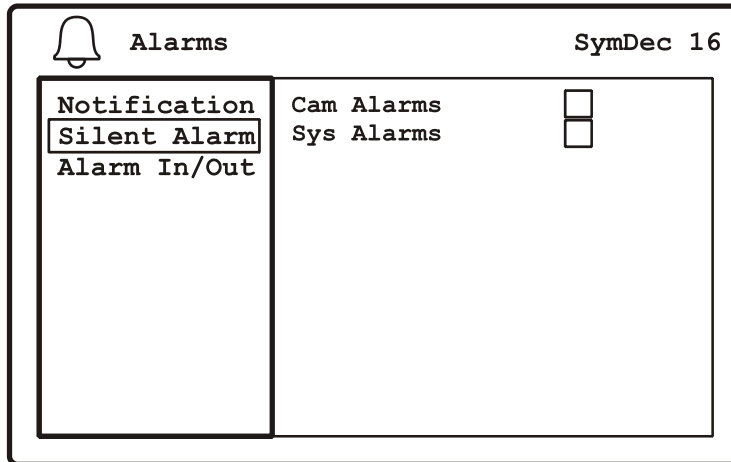

Alarm Inputs and Outputs

Use this menu to attach the specified alarm inputs and outputs to the selected camera.

Figure 34. The Alarms/Alarms Inputs and Outputs menu

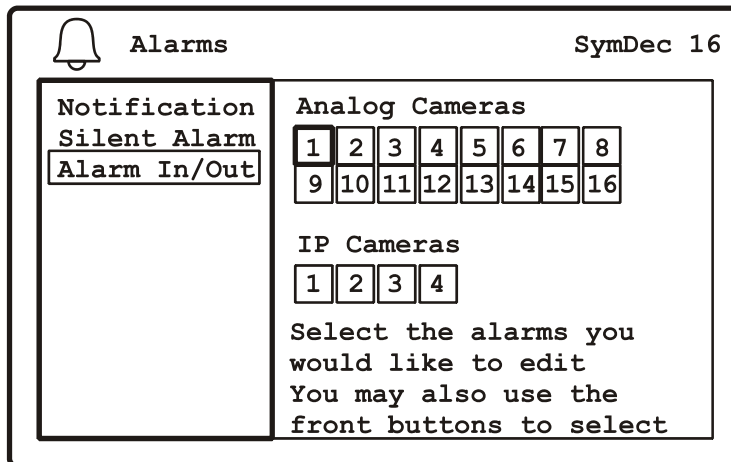

Note: Select Analog or IP and camera number

Figure 35. The Alarms/Alarms Inputs and Outputs menu after camera selection

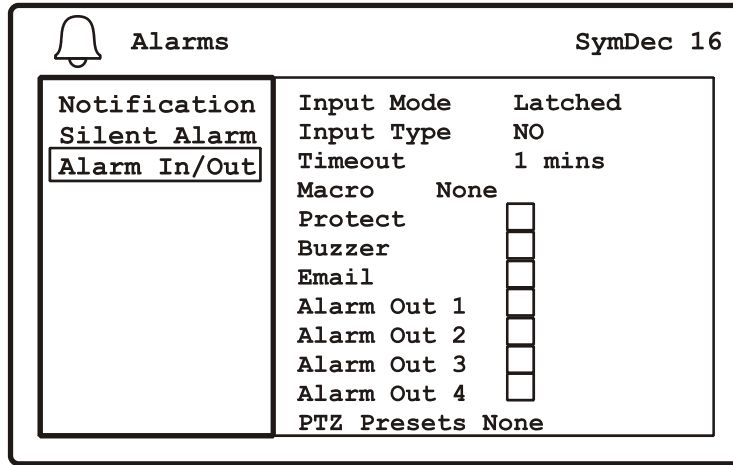

Table 24. The Alarms/Alarms Inputs and Outputs menu options

Menu Option	Setting
Input Mode	<ul style="list-style-type: none"> Latched: The alarm is activated until it is silenced and acknowledged. Transparent: The alarm is active only while receiving alarm input Timeout: The alarm condition is latched for the amount of time specified in the <i>Timeout</i> field.
Input type	Normally Open, Normally Closed
Timeout	0-59 minutes if Timeout selected in Input mode
Macro	None, Select Macro name (to select Macro Name you must have created and named a macro in the <i>Schedule/Macros</i> menu)
Protect	Enable or Disable
Buzzer	Enable or Disable
Email	Enable or Disable
Alarm Out 1	Enable or Disable
Alarm Out 2	Enable or Disable
Alarm Out 3	Enable or Disable
Alarm Out 4	Enable or Disable
PTZ Presets	Enable, Address Presets, Presets 1-4 (launches the PTZ preset submenu where you can assign an <i>Enable flag</i> , <i>Bus address</i> , <i>PTZ address</i> , and <i>Preset number</i>).

The Users menu

Highlight the *Users* icon and press the *enter* button. The *Users* menu will appear. Up to 24 users can be logged on to a SymDec 16 plus 4 at one time.

Figure 36. The Users menu

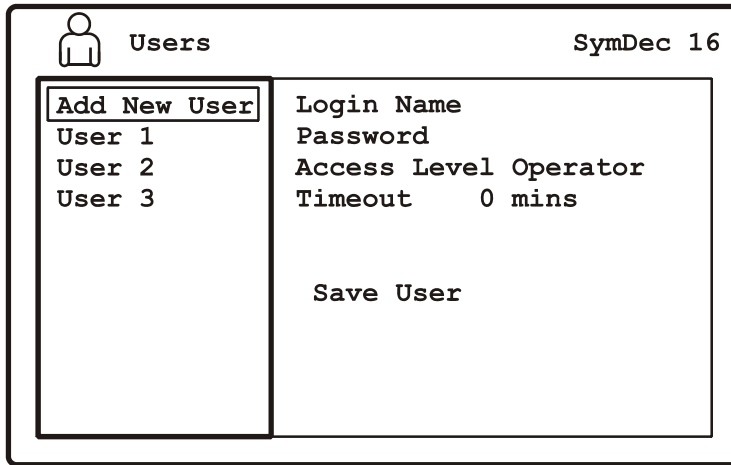

The Users menu contains the following options and their settings:

- Add New User
- Edit Users 1-3

Add New User

Use this menu to add a new user, assign a password, and select the users access level. Press enter to enter the edit window and use the keypad to create the user's name.

Figure 37. The Users/Add New User menu

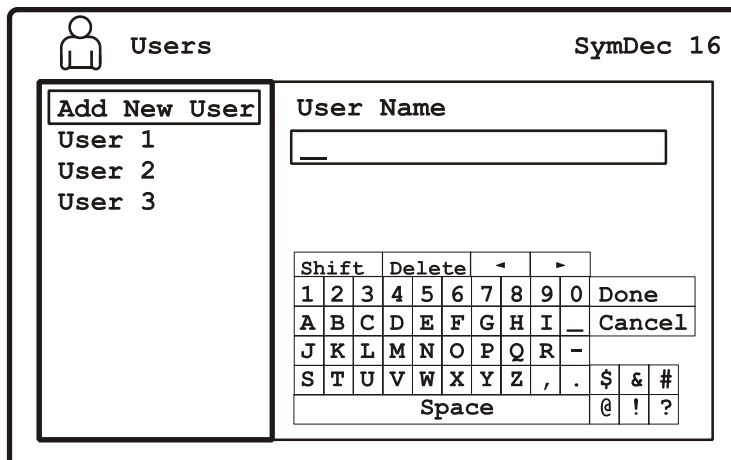

Edit Users

Use this menu to edit a user’s name, password, access level, and timeout. You can also delete a user from this menu.

Figure 38. The User/Edit User

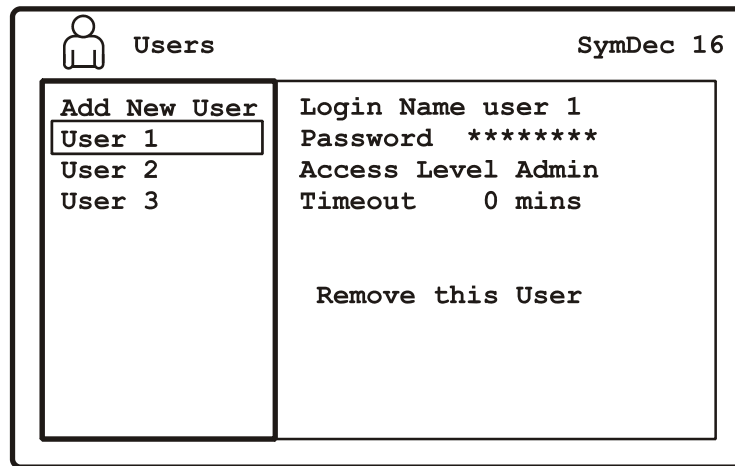

Table 25. The User/Edit User options

Menu options	Settings
Login Name	Press enter to enter the edit window and use the keypad to edit the user’s name.
Password	Enter from 4 to 8 characters.
Access Level	<ul style="list-style-type: none"> • Operator: Access to Display Info menus only • Manager: Access to Users, Display, and Info menus only • Administrator: Full access to all menus
Timeout	0-999 minutes. At 0 minutes the unit will never timeout (log out).
Remove this User	Select to delete user.

The Network menu

Highlight the *Network* icon and press the *enter button*. The *Network* menu will appear. The Network menu contains the following options and their settings:

- IP Settings
- IP Advanced
- Services
- Streaming
- Passthrough
- Notification
- Email Setup
- Notification Setup

IP Settings

Use this menu to setup the basic IP addresses and set the Ethernet password.

Figure 39. The Network/IP Settings menu

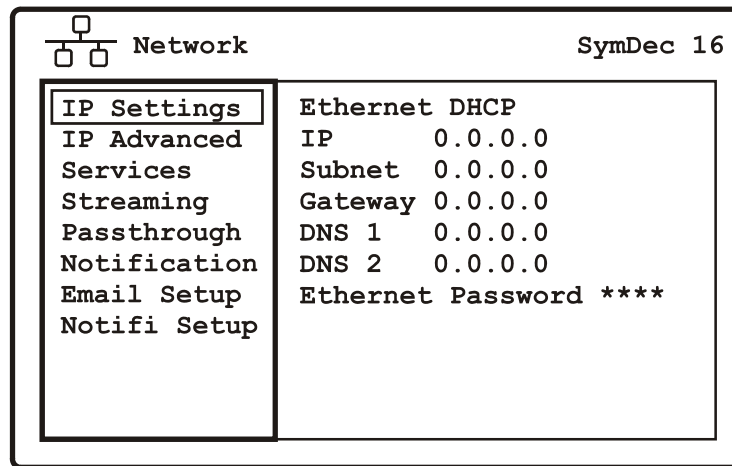

Table 26. The Network/IP Settings menu options

Menu options	Settings
Ethernet mode	Disabled, Static, DHCP , and PPPoE
IP Address	Consult with a qualified network administrator or IT professional to configure these settings if DHCP is not selected.
Subnet Mask	Consult with a qualified network administrator or IT professional to configure these settings if DHCP is not selected.
Gateway	Consult with a qualified network administrator or IT professional to configure these settings if DHCP is not selected.
Dynamic Name Server 1	Consult with a qualified network administrator or IT professional to configure these settings if DHCP is not selected.
Dynamic Name Server 2	Consult with a qualified network administrator or IT professional to configure these settings if DHCP is not selected.
Ethernet Password	Enter 4 to 8 characters to enable.

IP Advanced

Use this menu to configure these advanced network settings. Consult with a qualified network administrator or IT professional to configure these settings.

Figure 40. The Network/IP Advanced menu

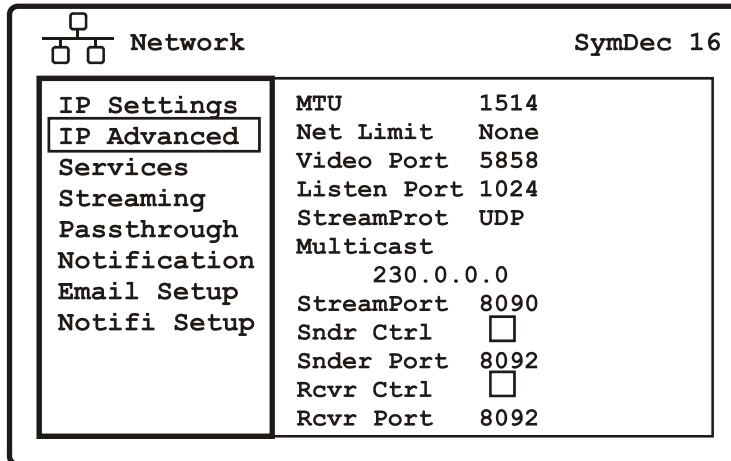

Table 27. The Network/IP Advanced menu options

Menu Options	Settings
MTU	1514 is the default. Sets the maximum TCP packet size.
Net Limit	None, 0-3999 Kbps.
Video Port	5858 is the default setting.
Listen Port	1024 is the default. This is the port that the SymDec 16 uses to listen for streaming commands
Streaming Protocol	UDP, TCP
Multicast IP address	230.0.0.0. is the default. This must match between devices.
Streaming Port	8090 is the default setting for the stream.
Sender Control	Enable or Disable. Must be enable to send IP video.
Sender Port	8092 is the default setting. If you change this port here make sure you also change to match on the Receiver device.
Receiver Control	Enable or Disable. Must be enabled to receive IP video.
Receiver Port	8092 is the default setting. If you change this port here make sure you also change to match on the Sender device.

Multicast Video Streaming Overview

Video streaming is a new concept to many, so we have included the following overview. A certain level of IP network knowledge is required to properly set up video streaming

Video Streaming is the process that the SymDec family, including SymNet and the Symveo IP camera use to listen on a specific UDP/TCP port for control messages and respond to them. The communication over this protocol can be between a PC application, such as SymNav software and any of the above products. The UDP/TCP port is configurable. The default port setting is 8092. IP Multicast is also supported.

IP Multicast

IP multicast is a bandwidth-conserving technology that reduces traffic by simultaneously delivering a single stream of information to thousands of recipients. IP Multicast delivers source traffic to multiple receivers without adding any additional burden on the source or the receivers while using the least network bandwidth of any competing technology. High-bandwidth applications, such as MPEG video, may require a large portion of the available network bandwidth for a single stream.

Note: Configured incorrectly IP multicast can become a serious drain on your networks resources! If you are at all uncertain on how to setup IP multicast, please contact your network administrator or IS professional.

The Internet Assigned Numbers Authority (IANA) controls the assignment of IP multicast addresses. It has assigned the Class D address space to be used for IP multicast. This means that all IP multicast group addresses will fall in the range of 224.0.0.0 to 239.255.255.255. This address range is only used for the group address or destination address of IP multicast traffic. The source address for multicast video is always the source or senders IP address.

UDP Sender and UDP Receiver Overview

UDP (User Datagram Protocol), is a connectionless protocol that, like TCP, runs on top of IP networks. Unlike TCP/IP, UDP/IP provides very few error recovery services, offering instead a direct way to send and receive datagrams over an IP network. It's used primarily for broadcasting messages over a network. A UDP sender sends out digital video over an IP network. A UDP sender can be the SymDec 4, SymDec 16 plus 4, Symveo IP Camera, or SymNet (Encoder). A UDP receiver is typically a SymDec 16, SymNav software, or a SymDec 4, which can display and record the streamed video. The SymNet (Decoder) can also be setup as a receiver, but it can only display the streamed video since it does not have recording capability.

To prevent a waste of network resources, the UDP sender does not send out streaming video until a receiver informs the sender that it is interested in receiving the stream. The UDP receiver sends out a *START* message every 30 seconds to the IP address in its streaming settings menu. The streaming settings page is located on the receiving device's web page.

When a sender receives a *START* message, it will start streaming out to the receiver's that are requesting it. When the sender does not receive any *START* message for one minute, it will stop sending to that device.

To speed up the initialization process after bootup and configuration changes, The UDP sender sends out a *READY_TO_SEND* message to the multicast IP address. When the receiver gets this message, it will send out the *START* message immediately if it is configured to receive from that sender (It does not wait for 30 seconds).

Note: The above information also applies if your Sender and Receiver are configured to use TCP instead of UDP.

SymNav software

SymNav software is the next generation of software that supports MPEG4 based video compression. The SymDec 4, SymDec 16 plus, SymNet, and SymVeo IP Camera all use MPEG4 compression.

SymNav software also connects to these products using UDP/TCP protocols depending on what is configured. The default setting is UDP. Changing from UDP to TCP or TCP to UDP is accomplished through the SymNav software application.

SymNav software can connect to a maximum of 4 video streams. This can be 4 separate SymDec units with 1 stream each or 2 SymDecs with 2 streams each.

Services

Use this menu to define the parameters of the networks services. Consult with a qualified network administrator or IT professional to configure these settings

Figure 41. The Network/Services menu

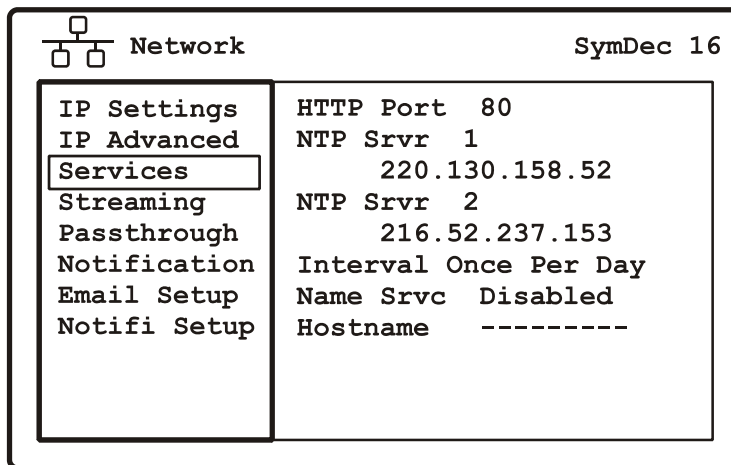

Table 28. The Network/Services menu options

Menu Options	Settings
HTTP Port	80 is the default. Select from 0 to 65535. To disable SymBrowser access select 0 as the port number.
NTP Server 1 IP Address	IP Address
NTP Server 2 IP Address	IP address
Interval	Never, Once per Hour, Twice per Day, Once per Day
Name Service	Disabled, DynDNS, TZO, GnuDIP
Hostname	The default hostname is the unit's serial number.

Streaming

Use this menu to enable streaming output on an IP camera.

Figure 42. The Network/Streaming menu

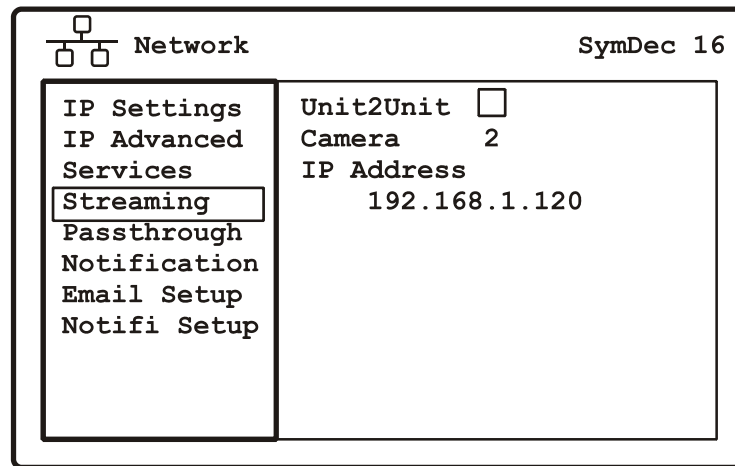

Table 29. The Network/Streaming menu options

Menu Options	Settings
Unit 2 Unit	Enable or Disable streaming
Camera	1 to 16
IP Address	Select the IP address of the camera

To receive unicast video from another unit

1. Go to *Cameras/IP Camera 1*. Set the source address to the physical address of the unit sending a unicast video stream. You can repeat this for IP Cameras 2 to 4.

To receive multicast video from different units

1. Navigate to the *Network/IP Advanced/Multicast setting*. Set the Multicast address of the stream you are going to receive to 230.123.456.789.

Note: Note that if there are four units sending multicast streams, each unit must have the same multicast stream address.

2. Navigate to *Cameras/IP Camera 1*. Set the source address to the physical address of the unit sending a multicast video stream. You can repeat this for IP Cameras 2 to 4.

Serial Passthrough

Use this menu to select the serial passthrough mode, remote IP address, port number, serial port type, and autoconnect enable/disable.

Serial pass-through functionality is for receiving or sending serial commands such as PTZ commands over the Internet. To setup serial pass-through;

1. Set the Mode to *Sender* or to *Receiver*. This is for the SymDec 16 plus 4 to either send or receive data.
2. Select the Remote IP and the Port number of the unit you want to send/receive serial pass-through data. Both units must have the same port number.
3. The Serial Port option specifies which port you want to send/receive serial data.
4. Make sure that the *Auto-Connect* checkbox is checked as it maintains the serial port as active.

Figure 43. The Network/Serial Passthrough menu

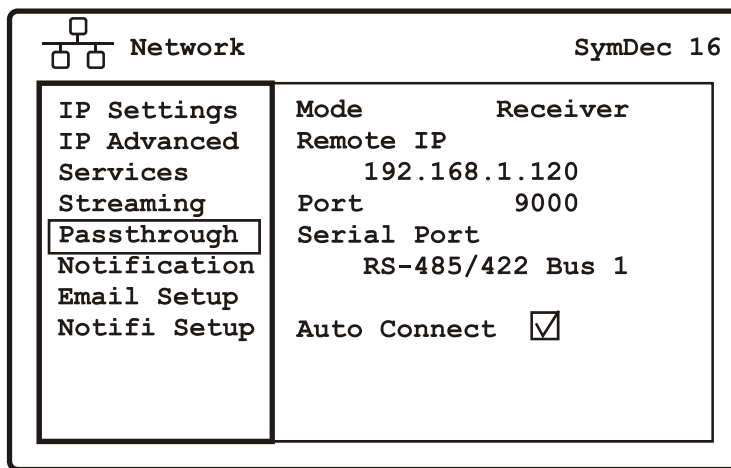

Table 30. The Network/Serial Passthrough menu options

Menu Options	Settings
Mode	Receiver or Sender
Remote IP	Enter the IP address of the remote device
Port	9000
Serial Port	RS-485/422 Bus 1, RS-485/422 Bus 2, None
Auto Connect	Enable or Disable

Email/TCP Notification

Use this menu to select the method of notification (email or TCP) for the following incidents:

- Notify on Record
- Notify on Archive
- Notify on Menu Access
- Notify on Power Up
- Notify on Connection
- Notify on Alarm
- Notify on Video Loss

Select a checkmark in either box to enable.

Figure 44. The Network/Notification menu

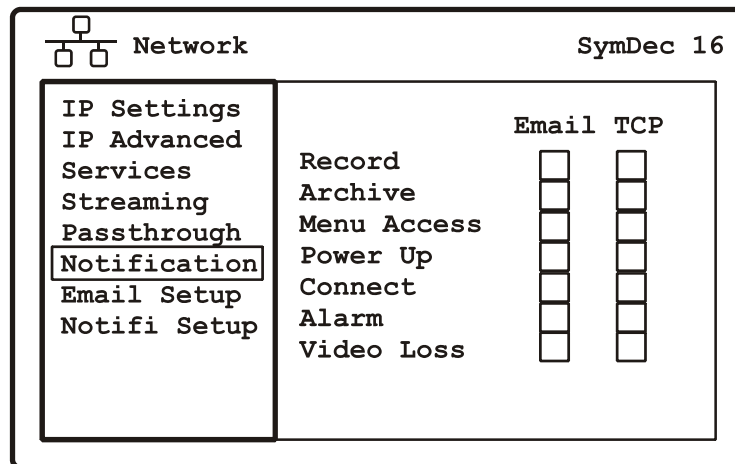

Email Setup

Use this menu to setup the email locations where notifications will be sent.

Figure 45. The Network/Email Setup menu

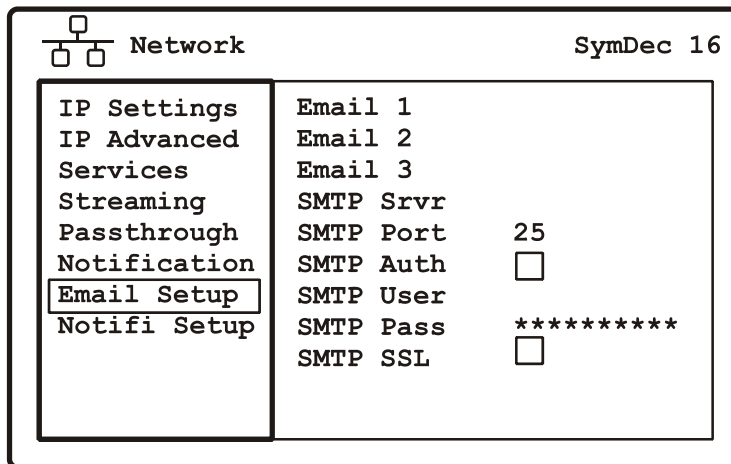

Table 31. The Network/Email Setup menu options

Menu Options	Settings
Email 1	1st email address
Email 2	2nd E-mail address
Email 3	3rd email address
SMTP Server	Enter a valid Simple Mail Transfer Protocol (SMTP) name
SMTP Port	Default is 25
SMTP Authorization	Check to enable or disable
SMTP User	Enter a valid SMTP username
SMTP Password	1 to 10 characters
SMTP SSL	Enable or disable SSL (Secure Sockets Layer) encryption

Notification Setup

Use this menu to setup the TCP/IP addresses where notification is to be sent.

Figure 46. The Network/Notification Setup menu

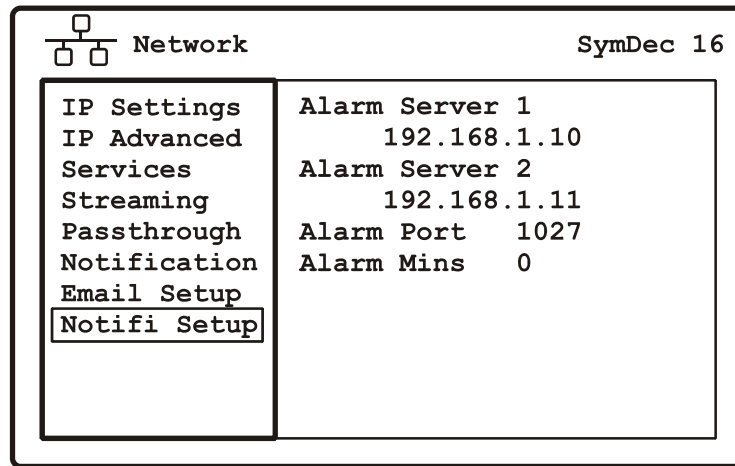

Table 32. The Network/Notification Setup menu options

Menu Options	Settings
Alarm Server 1	Enter a primary alarm server IP address
Alarm Server 2	Enter a backup alarm server IP address
Alarm port	Default is 1027. Choose from 1024 to 32767.
Alarm Minutes	0 to 299. Minutes after the event to send notification

The Display menu

Highlight the *Display* icon and press the *enter* button. The *Display* menu will appear.

Figure 47. The Display menu

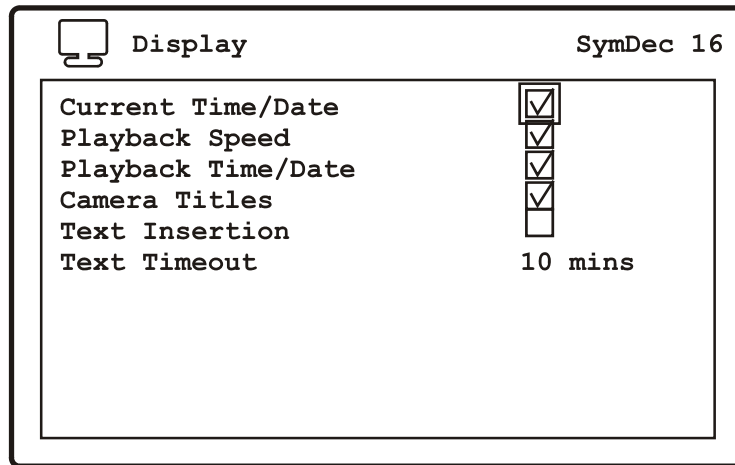

The Display menu contains the following options and their settings:

- Current Time/Date
- Playback Speed
- Playback Time/Date
- Camera Titles
- Text Insertion: Inserts serial -based text.
- Text Timeout: 0-99 minutes (the length of time the text is displayed in minutes)

Enter a checkmark in the box to enable.

The System menu

Highlight the *System* icon and press the *enter* button. The *System* menu will appear. The *System* menu contains the following options and their settings:

Front Panel

Use this menu to setup the front panel features. The remote control ID setup is also configured here.

Figure 48. The System/Front Panel menu

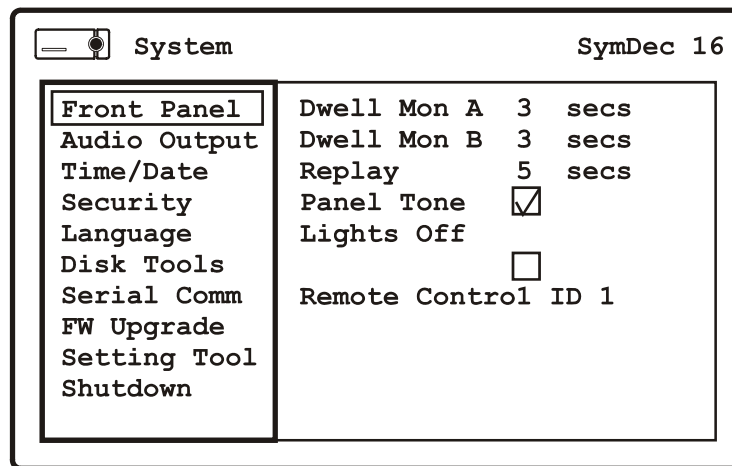

Table 33. The System/Front Panel menu options

Menu Options	Settings
Dwell Monitor A	0-99 seconds
Dwell Monitor B	0-99 seconds
Replay	0-999 seconds
Panel Tone	Enable or disable
Lights Off	Enable or disable
Remote Control ID	Select from disable, and 1 to 4

Audio Output

This menu allows you to select local or remote audio. Local audio is audio received from the audio inputs on the SymDec 16 and recorded with the video. Remote audio is audio received for a PC client and is not recorded, but passed through to the audio output.

Figure 49. System/Audio Output menu

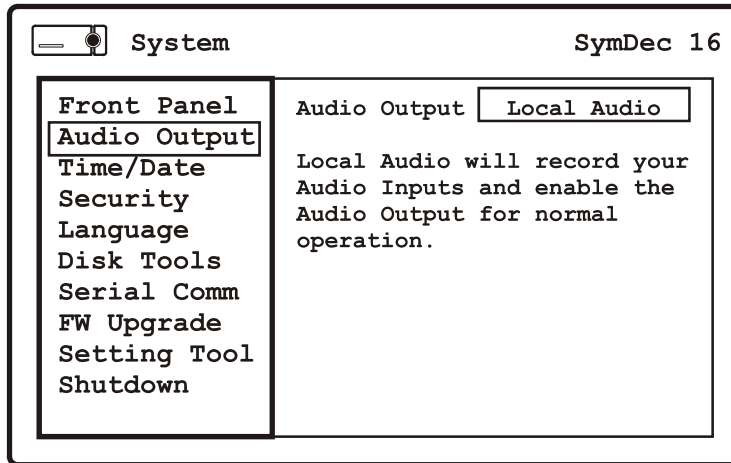

Time/Date

Use this menu to setup the time and date features of the SymDec 16 plus 4.

Figure 50. The System/Time and Date menu

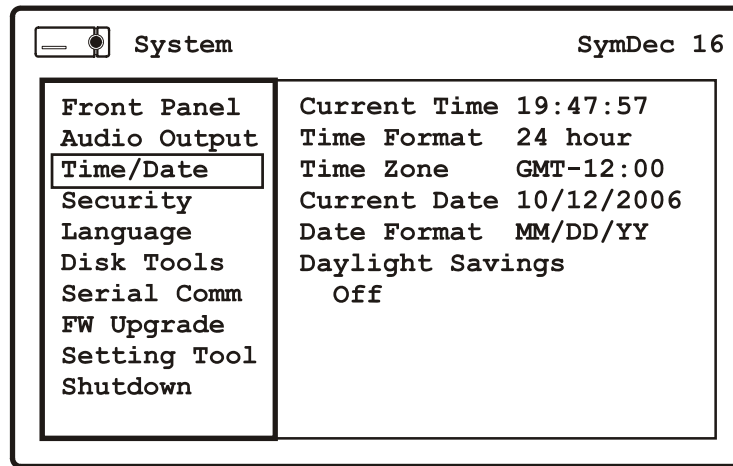

Table 34. The System/Time and Date menu options

Menu Options	Settings
Current Time	Press the enter button when selected to enter the time.
Time Format	12 or 24

Table 34. The System/Time and Date menu options

Menu Options	Settings
Time Zone	<ul style="list-style-type: none"> • GMT: Casablanca, Monrovia, Dublin, Edinburgh, Lisbon, London • GMT-01:00: Azores, Cape Verde Is. • GMT-02:00: Mid-Atlantic • GMT-03:00: Brasilia, Buenos Aires, Georgetown, Greenland • GMT-03:30: Newfoundland • GMT-04:00: Atlantic Time (Canada), Caracas, La Paz, Santiago • GMT-05:00: Bogata, Lima, Quito, Eastern Time (US & Canada), Indiana (East) • GMT-06:00: Central America, Central Time (US & Canada), Mexico City, Saskatchewan • GMT-07:00: Arizona, Mountain Time (US & Canada) • GMT-08:00: Pacific Time (US & Canada), Tijuana • GMT-09:00: Alaska • GMT-10:00: Hawaii • GMT-11:00: Midway Island, Samoa • GMT-12:00: Eniwetok, Kwajalein • GMT+01:00: Amsterdam, Berlin, Bern, Rome, Stockholm, Vienna, Belgrade, Bratislava, Budapest, Ljubljana, Prague, Brussels, Copenhagen, Madrid, Paris, Sarajevo, Skopje, Sofija, Vilnius, Warsaw, Zagreb, West Central Africa • GMT+02:00: Athens, Istanbul, Minsk, Bucharest, Cairo, Harare, Pretoria, Helsinki, Riga, Tallinn, Jerusalem • GMT+03:00: Baghdad, Kuwait, Riyadh, Moscow, St. Petersburg, Volgograd, Nairobi • GMT+03:30: Tehran • GMT+04:00: Abu Dhabi, Muscat, Baku, Tbilisi, Yerevan • GMT+04:30: Kabul • GMT+05:00: Ekaterinburg, Islamabad, Karachi, Tashkent • GMT+05:30: Calcutta, Chennai, Mumbai, New Delhi • GMT+05:45: Kathmandu • GMT+06:00: Almaty, Novosibirsk, Astana, Dhaka, Sri Jayawardenepura • GMT+06:30: Rangoon • GMT+07:00: Bangkok, Hanoi, Jakarta, Krasnoyarsk • GMT+08:00: Beijing, Chongqing, Hong Kong, Urumqi, Irkutsk, Ulaan Bataar, Kuala Lumpur, Singapore, Perth, Taipei • GMT+09:00: Osaka, Sapporo, Tokyo, Seoul, Yakutsk • GMT+09:30: Adelaide, Darwin • GMT+10:00: Brisbane, Canberra, Melbourne, Sydney, Guam, Port Moresby, Hobart, Vladivosstok • GMT+11:00: Magadan, Solomon Is, New Caledonia
Current Date	Press the enter button when selected to enter the date
Date Format	MM/DD/YYYY or YYYY/MM/DD
Daylight Savings Time	Select Off, U.S.A., North America, Europe, Australia, New Zealand, or Russia

Note: North America is DST times from 2006, USA is set for the newly proposed dates in 2007.

Security

Use this menu to setup the security features of the SymDec 16 plus 4. This menu allows you to select the user type (Administrator, Operator, Manager) to allow access to these features. Selecting *Any* allows any user type access to modify these security operations.

Figure 51. The System/Security menu

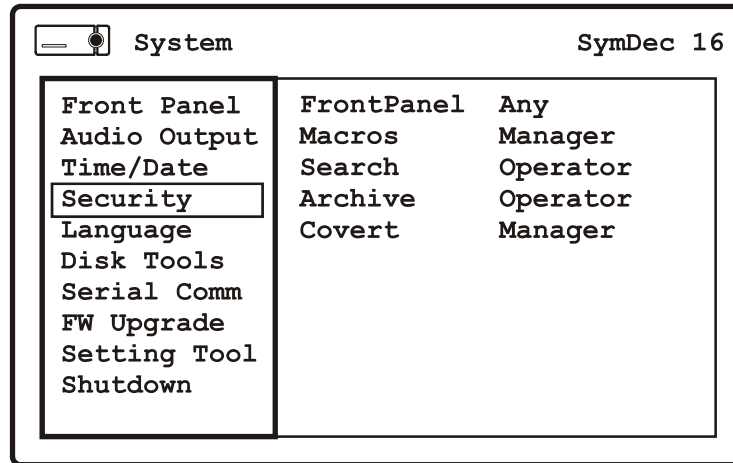

Table 35. The System/Security menu options

Menu Options	Settings
Front Panel	Any, Administrator, Operator, Manager
Macros	Any, Administrator, Operator, Manager
Search	Any, Administrator, Operator, Manager
Archive	Any, Administrator, Operator, Manager
Covert	Any, Administrator, Operator, Manager

Languages

Use this menu to setup the language and currency usage

Figure 52. The System/Language menu

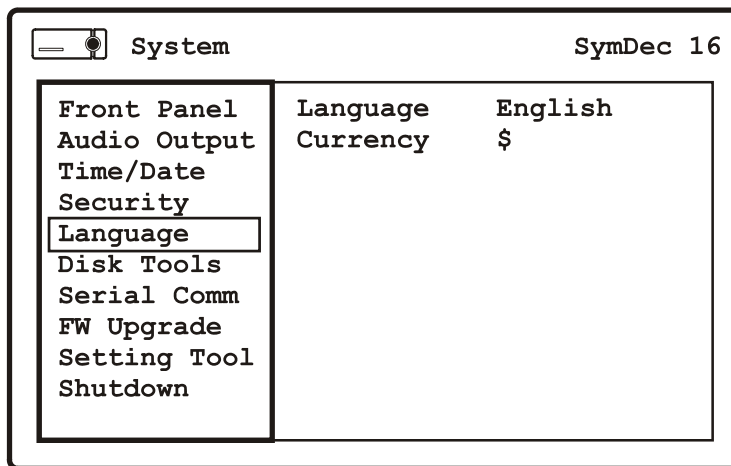

Table 36. The System/Language menu options

Menu Options	Settings
Language	English, Turkish, Swedish, Spanish, Russian, Portuguese, Polish, Italian, Hungarian, German, Finnish, Dutch, Danish, Czech, French
Currency	\$ (Select currency type for text insertion purposes)

Disk Tools

Use this menu to access the SymDec 16 plus 4's hard disk maintenance features.

Figure 53. The System/Disk Tools menu

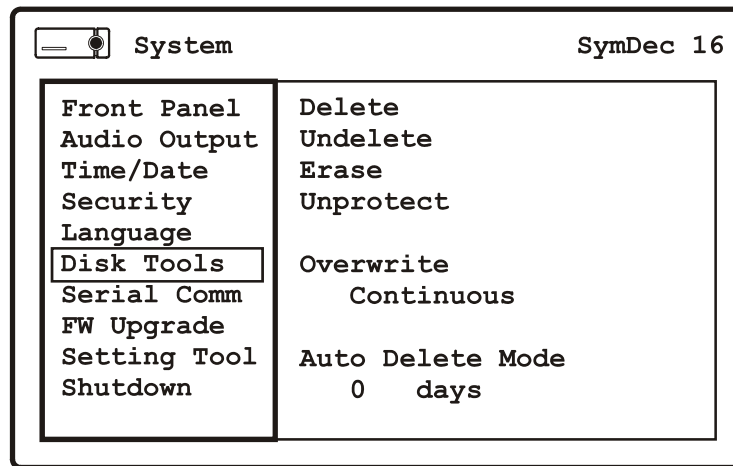

Table 37. The System/Disk Tools men options

Menu Options	Settings
Delete	Select and press the enter button to delete all data on the hard drives. Requires PIN number.
Undelete	Select and press the enter button to undelete all data on the hard drives. Only works after a delete command. Requires PIN number.
Erase	Select and press the enter button to erase all data on the hard drives. Requires PIN number. Data is not recoverable with the Undelete command.
Unprotect/Protect	All, By Clip, By Range (Protects/unprotects selections from deletion on hard disk)
Overwrite	<p>Continuous:</p> <ul style="list-style-type: none"> • Recording always starts at end of last recording. • The unit overwrites all previously recorded data. • The unit overwrites newly recorded data (data from the current record session). • Unit never stops recording. <p>Write Once:</p> <ul style="list-style-type: none"> • Recording always starts at end of last recording. • The unit overwrites all previously recorded data. • Recording stops before the unit overwrites any of the newly recorded data (data from the current record session). • When the end of the disk is reached, the unit displays an on-screen message indicating that the disk is full, and the unit has stopped recording. User must acknowledge the on-screen message by clicking the Enter button. • The unit will continue recording again when the user clicks the Record button. <p>No Overwrite:</p> <ul style="list-style-type: none"> • Recording always starts at end of last recording. • Recording stops when end of disk is reached (when disk is full). • When the end of the disk is reached, the unit displays an on-screen message indicating that the disk is full, and the unit has stopped recording. User must acknowledge the on-screen message by pressing the Enter button. • Unit will not record over previously recorded data.
Auto Delete Mode (ADM)	0-999 days (prevents the unit from displaying or archiving any data that is more than the selected number of days old. This feature may be required by law in some jurisdictions, please consult with the local authorities).

Serial Communications

Use these menus to setup the serial communication properties of the SymDec 16 plus 4.

RS-485/RS-422

This menu sets the I/O connector on the rear panel to RS-485 or RS-422.

Figure 54. The System/RS-485 and RS-422 menu

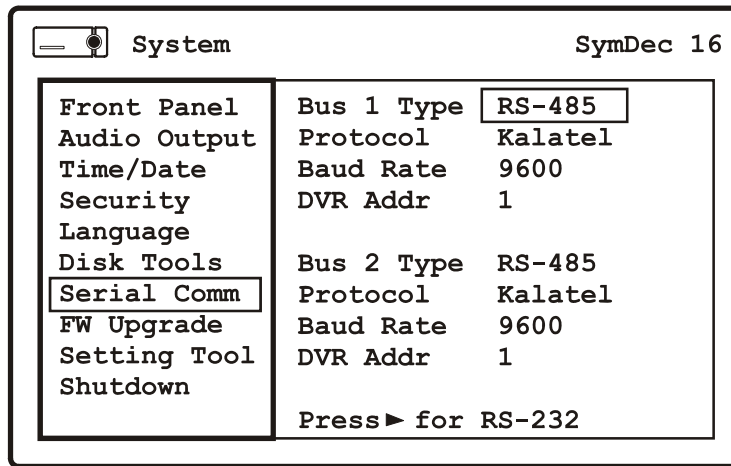

Table 38. The System/RS-485 and RS-422 menu options

Menu Options	Settings
Bus 1 Type	RS-485 or RS-422
Protocol	Kalatel, Passthrough, Power Dome, BaxNet, Digiplex, Pelco P, Pelco D (Kalatel is used for controlling PTZ cameras using SymNav. Passthrough is referring to serial passthrough which is setup in the <i>Network/Passthrough</i> dialog. If you set Bus 1 to serial passthrough then the Protocol options must be set to Passthrough.
Baud Rate	300, 1200, 2400, 4800, 9600, 19200
DVR Address	0-199
Bus 2 Type	RS-485 or RS-422
Protocol	Kalatel, Passthrough, Power Dome, BaxNet, Digiplex, Pelco P, Pelco D
Baud Rate	300, 1200, 2400, 4800, 9600, 19200
DVR Address	0-199 (Dome addressing)

RS-232

Use this menu to setup the RS-232 parameters of the RS-232 connector on the rear panel.

Figure 55. The System/Serial Communication/RS-232

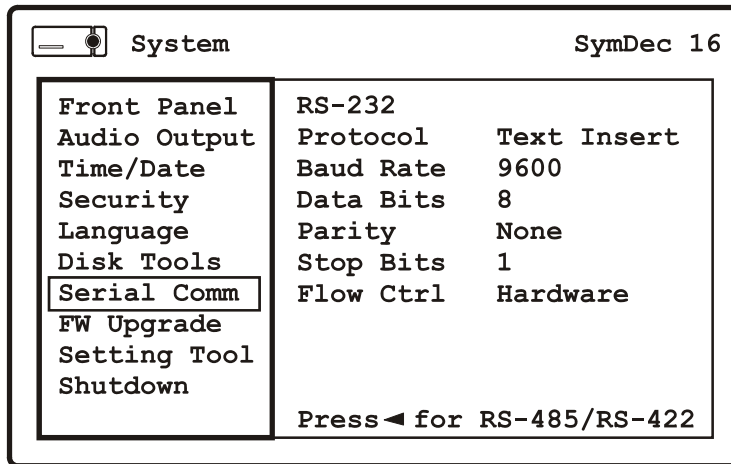

Table 39. The System/Serial Communication/RS-232 options

Menu Options	Settings
Protocol	Text Insertion
Baud Rate	300, 1200, 2400, 4800, 9600, 19200, 38400, 57600, 115200
Data Bits	5, 6, 7, 8
Parity	None, Even, Odd
Stop Bits	1 or 2
Flow Control	None, Xon, Xoff

Firmware Upgrade

Use this menu to upgrade the firmware (from a USB flashdrive) of the SymDec 16 plus 4. To upgrade do the following:

1. Insert a USB flashdrive, with the flash upgrade file, into one of the USB ports.
2. Navigate to the *Upgrade Now* command and press the enter button.
3. The SymDec will reboot when completed.

Note: The flash upgrade file must be in the root directory of the flashdrive. Do not remove power while an upgrade is in-process.

Figure 56. The System/Firmware Upgrade menu

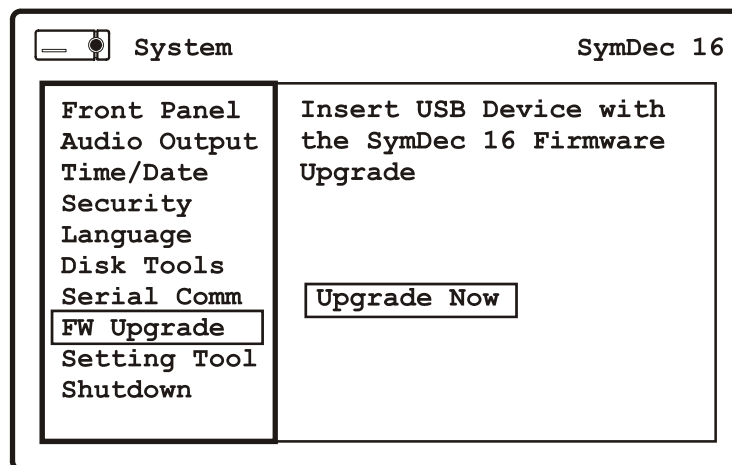

Setting Tool

Use this menu to restore factory setting, load and save settings to a USB flashdrive.

Figure 57. The System/Setting Tool

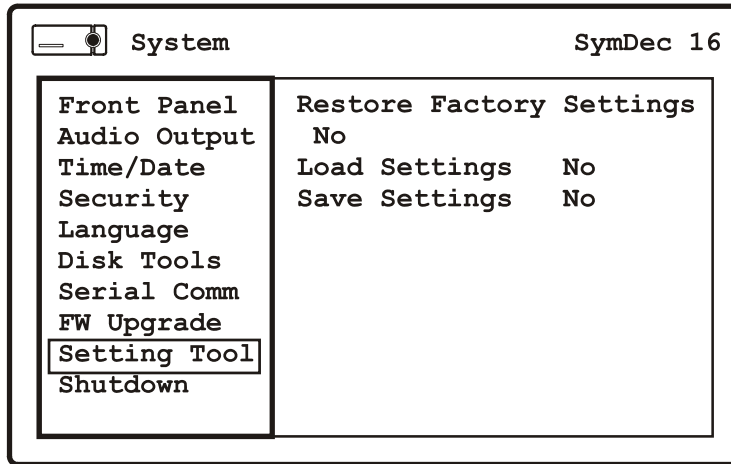

Table 40. The System/Setting Tool option

Menu Options	Settings
Restore Factory Settings	Select Yes to restore
Load Settings	Select Yes to load settings from a USB Flashdrive
Save Settings	Select Yes to save settings to a USB Flashdrive

Shutdown

Use this menu to shutdown the SymDec 16 plus 4 safely. Navigate to the *Shutdown Now* command and press the *enter* button. Enter the password and press the *enter* button.

Figure 58. The System/Shutdown menu

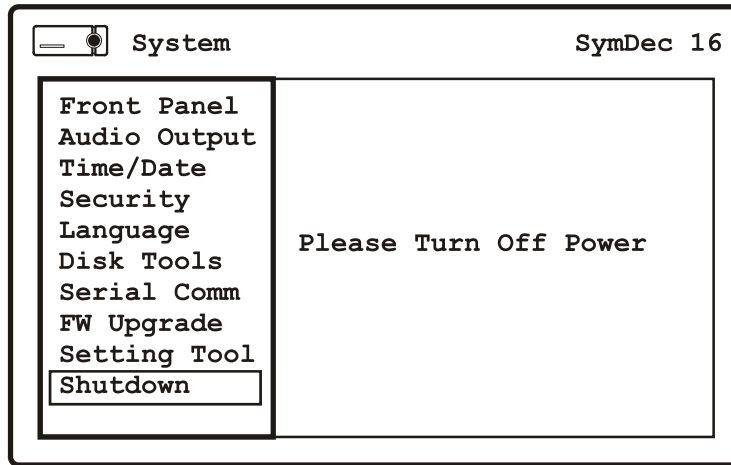

The Info menu

Highlight the *Info* icon and press the *enter* button. The *Info* menu will appear. The *Info* menu contains the following options and their settings:

Health

The Health menu display information on the following:

- System
- Disk 1 -4
- Fans 1-5

Figure 59. The Info/Health menu

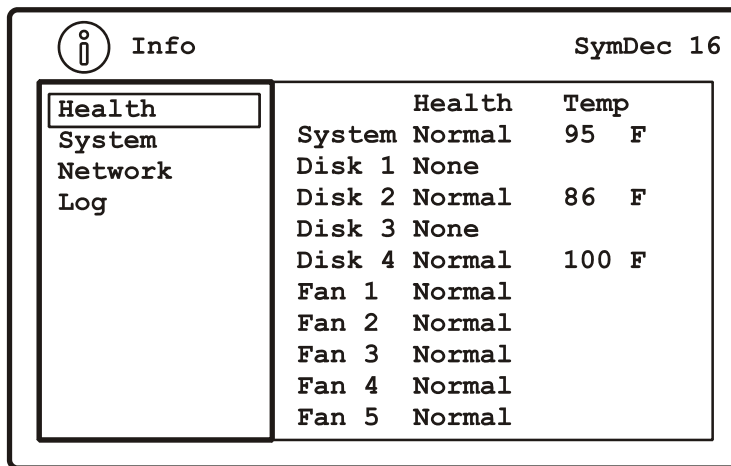

System

The System menu display information on the following:

- Model
- Serial Number
- Hostname
- Software Version
- Software Date
- BL Version
- FPGA Version
- Disk Size

Figure 60. The Info/System menu

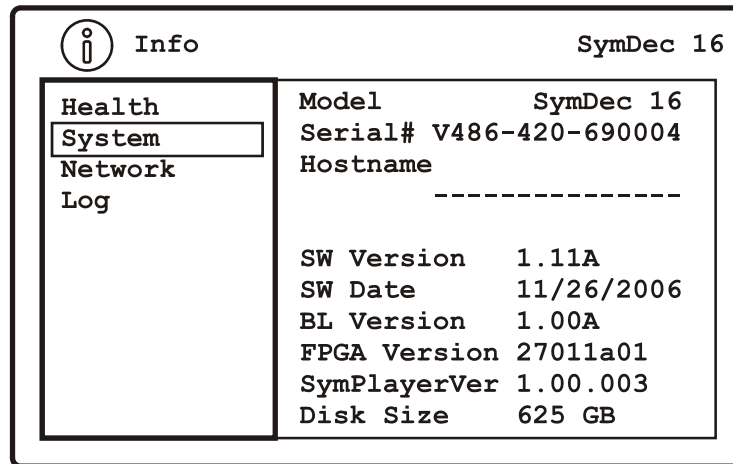

Network

The Network menu display information on the following:

- IP Address
- MAC Address
- DHCP Lease Expires
- Last DDNS Update Status
- Last DNS Update Success

Figure 61. The Info/Network menu

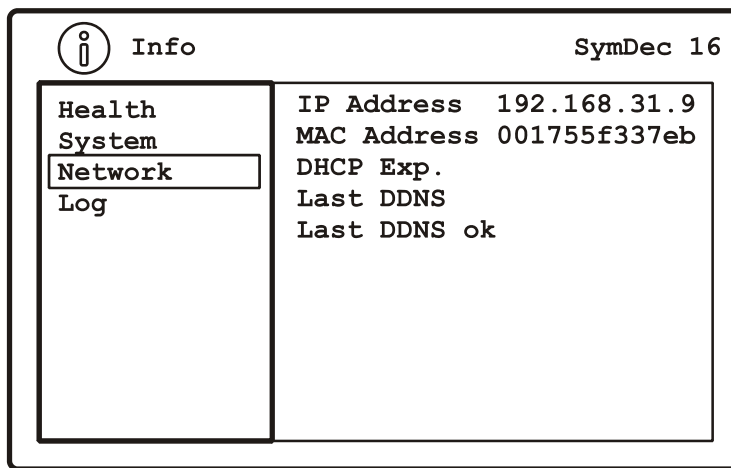

Log

The log menu allows you to save the Log file to a USB device.

Figure 62. The Info/Network menu

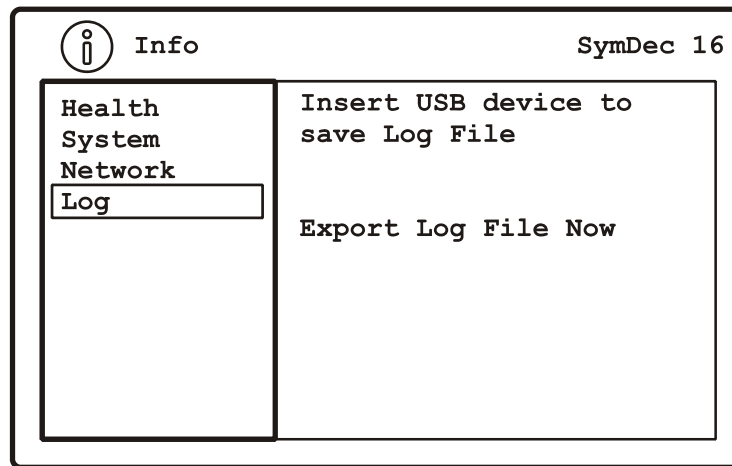

The log file provides information on unit status, unit information, and hard drive temperatures. An example log file is shown below.

```
SymDec16 Log
Serial Number: V406-206-6N0010
Mac Address: 001755f33906
12/21/2006 11:06:53 Network Link Down
12/21/2006 11:06:53 System Start
12/29/2006 04:43:59 Network Link Down
12/29/2006 04:43:59 System Start
01/05/2007 04:56:59 Network Link Down
01/05/2007 04:56:59 System Start
01/05/2007 05:05:08 Network Link Down
01/05/2007 05:05:08 System Start
01/10/2007 03:03:51 Network Link Down
01/10/2007 03:03:51 System Start
01/10/2007 03:45:06 Network Link Up
09/23/2006 00:01:31 Network Link Down
09/23/2006 00:01:31 System Start
09/23/2006 00:02:26 Network Link Up
09/23/2006 00:07:56 Network Link Down
09/23/2006 01:52:27 Network Link Up
```

Chapter 5 SymNav and SymBrowser

This chapter provides detailed information on

- how to install the *SymNav* video software; and
- how to access and use the embedded *SymBrowser*.

In this chapter:

- SymNav* 88
 - Minimum System Requirements* 88
 - Installing SymNav software from CD-ROM* 88
 - Starting SymNav software* 88
- The SymBrowser Webservice* 90
 - Search* 91
 - User* 92
 - Configure options* 93
 - Cameras* 94
 - Schedule* 102
 - Alarms* 104
 - Network* 106
 - System* 114
 - Info* 121
 - Symbrowser* 123

SymNav

SymNav software provides remote video viewing and SymDec 16 menu setup with your PC. Make sure all connections are completed, at a minimum the power cord, a viewing monitor, and an Ethernet cable must be connected from the SYmDec 16 plus 4 and your PC.

Minimum System Requirements

The following minimum system requirements must be met before software installation.

Windows® 2000/XP and Direct X are registered trademarks of Microsoft Corporation.

Table 41. SymNav minimum system requirements

Hardware	Specification
CPU	Pentium 2.8 GHz or faster
RAM	512 MB
Hard disk drive	50 MB free hard drive space
Monitor	SVGA, 1024 X 768, 24 bit color
Video	AGP or PCI Express, 128 MB DDR Memory Direct X Version 9 or higher
Operating system	Windows® 2000 SP4, XP SP2

Installing SymNav software from CD-ROM

To install software on your hard disk from a CD:

1. Place the SymNav software CD in the CD-ROM drive of a PC that meets the minimum system requirements.
2. Follow the instructions for installation as they appear.
- 3.

Note: If Autorun is not enabled on your PC, choose Run from the Start Menu, then type d:\setup.exe (where “d” is the drive letter of your CD-ROM) and click OK. Follow the instructions as they appear on your screen.

Starting SymNav software

To start the SymNav software, double-click on the SymNav software desktop icon  or choose *Programs* from the *Start menu* and then select *SymNav software*. The Main window of the SymNav software program will appear. For operating details, please see the SymNav software manual.

Note: The SymNav manual in pdf format is located on the SymNav software CD.

Figure 63. The SymNav main operation screen

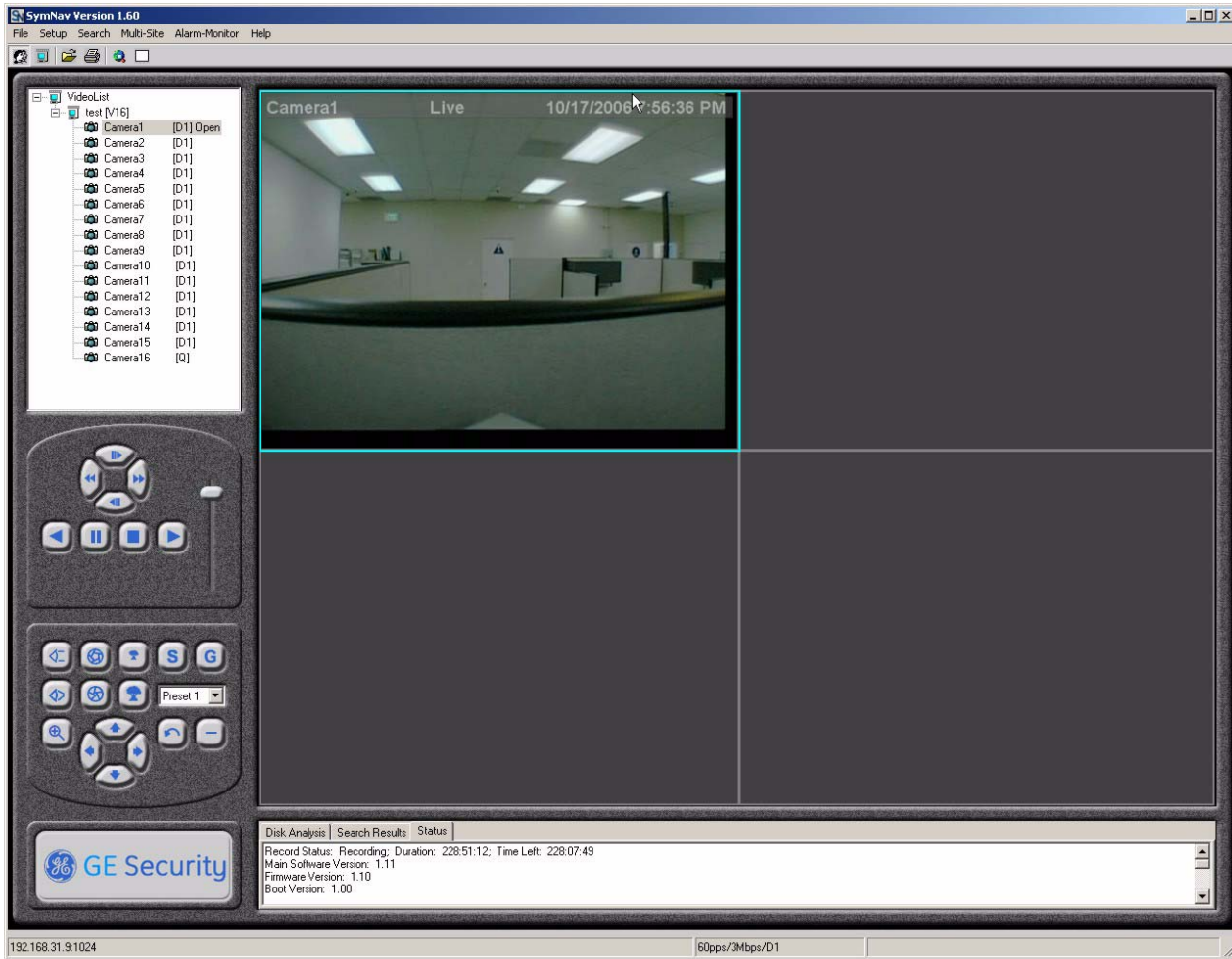

The SymBrowser Webserver

The SymDec 16 plus 4 has an integrated WebServer interface. The WebServer provides you the means to remotely configure, upgrade, and view information about the SymDec 16 plus 4. The default IP address from the factory is 192.168.1.82. To **disable** the SymBrowser, go to [Services](#) on page 63 and change the HTTP port number from the default 80 to 0.

To access the web interface:

1. Launch Internet Explorer (version 5.5 or later) on any local Internet connected PC or laptop.
2. Type in the unit's IP address (*192.168.1.82*) or *hostname* (see network settings page) in the address field and click enter.

Note: When launching, SymBrowser checks your system for the correct files. If they are not detected, SymBrowser will attempt to load them. Accept all General Electric signed content to allow the files to be loaded.

3. The *Enter Network Password* screen will appear. Enter your user name and password (PIN). See [Passwords](#) on page 7 for the default factory passwords.
4. The SymDec 16's SymBrowser home page window should appear.

Figure 64. SymDec 16 plus 4 SymBrowser home page

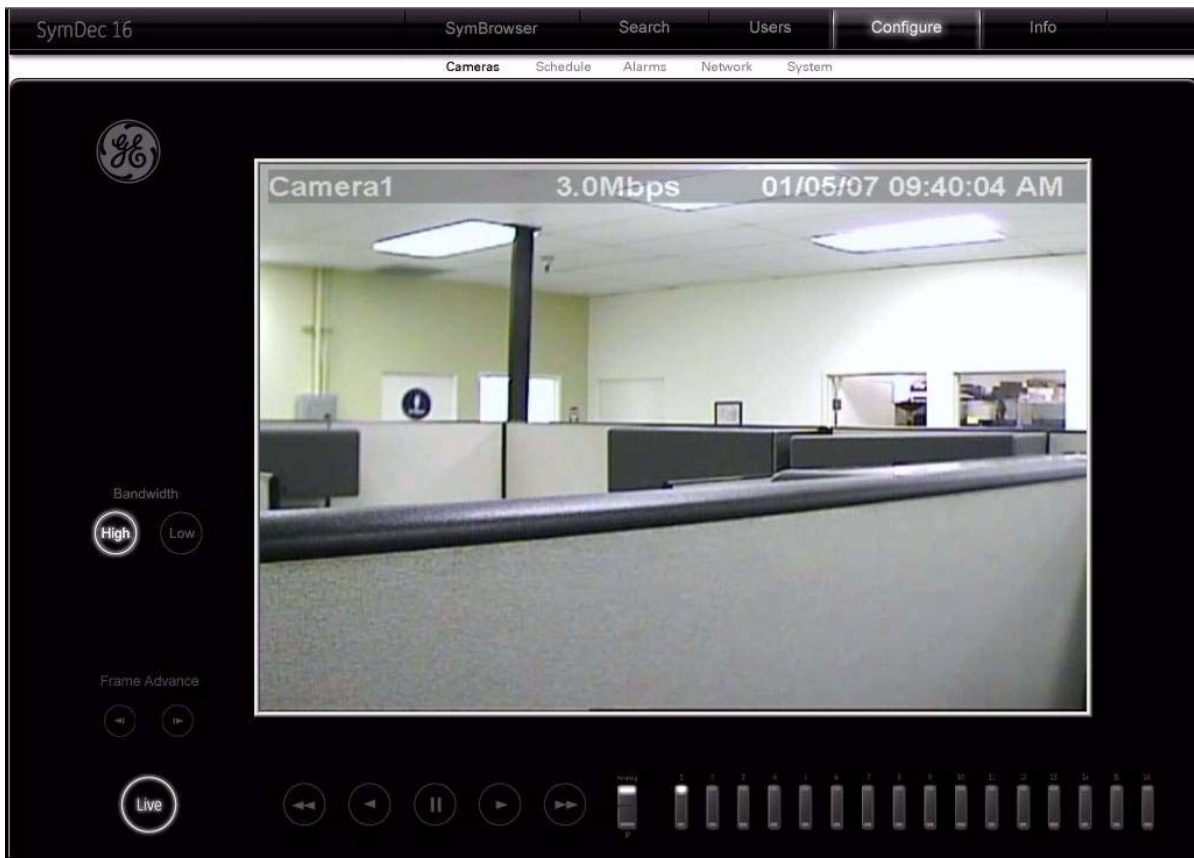

On this page you will find links for *SymBrowser*, *Search*, *User's*, *Configure*, and *Info*.

Note: The SymBrowser is discussed in detail at the end of this chapter.

Search

Clicking on the *Search* link will display the following user options:

- Disk Analysis screen
- Search by Dates
- Camera Motion
- Daily Hours selection
- Search for Alarms, Event and Text options

See *Searching* on page 126 for more detailed information on how to use these features.

Figure 65. The Search/Disk Analysis screen



User

Clicking on the *User* link will display the following user options:

- Add User
- Edit User

Add User

Click on the *Add User* link to display the *Add New* page. On this page you can:

- Enter a login name;
- Create a password;
- Enter a timeout in minutes; and
- Set the user's access levels.

Figure 66. Add new options

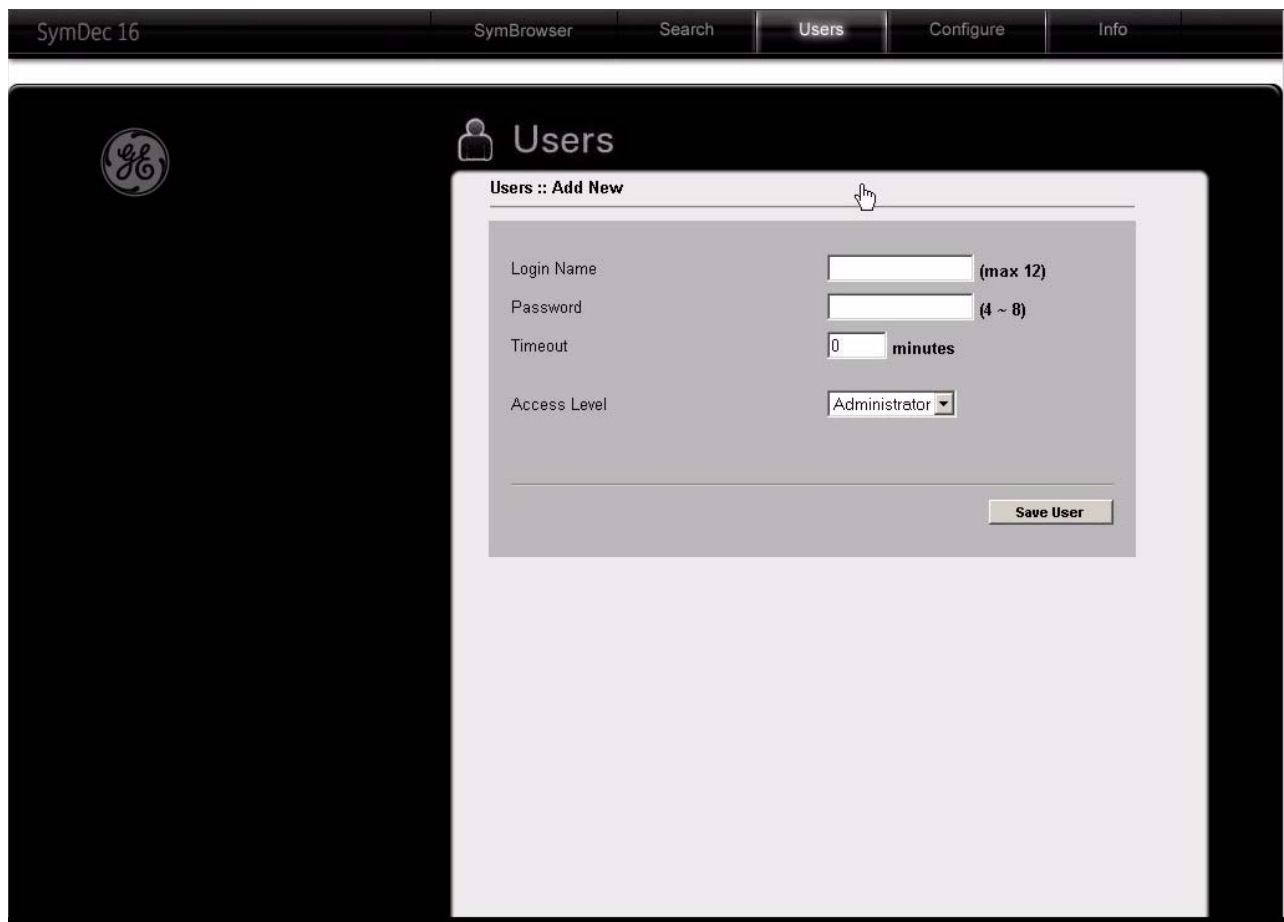

The screenshot displays the SymDec 16 web interface. At the top, a navigation bar includes 'SymDec 16', 'SymBrowser', 'Search', 'Users', 'Configure', and 'Info'. The main content area features the GE logo and a 'Users' header with a person icon. Below this is a 'Users :: Add New' form. The form contains the following fields: 'Login Name' with a text input and '(max 12)' label; 'Password' with a text input and '(4 ~ 8)' label; 'Timeout' with a text input containing '0' and 'minutes' label; and 'Access Level' with a dropdown menu showing 'Administrator'. A 'Save User' button is located at the bottom right of the form.

Note: Up to 24 users can be logged on at the same time.

Edit User

Click on the *Edit User* link to display the *Edit New* page. On this page you can:

- Edit a user's login name;
- Change a user's password;
- Change the user's timeout in minutes;
- Modify the user's access levels;
- Delete or Save the user.

Figure 67. The Edit User page

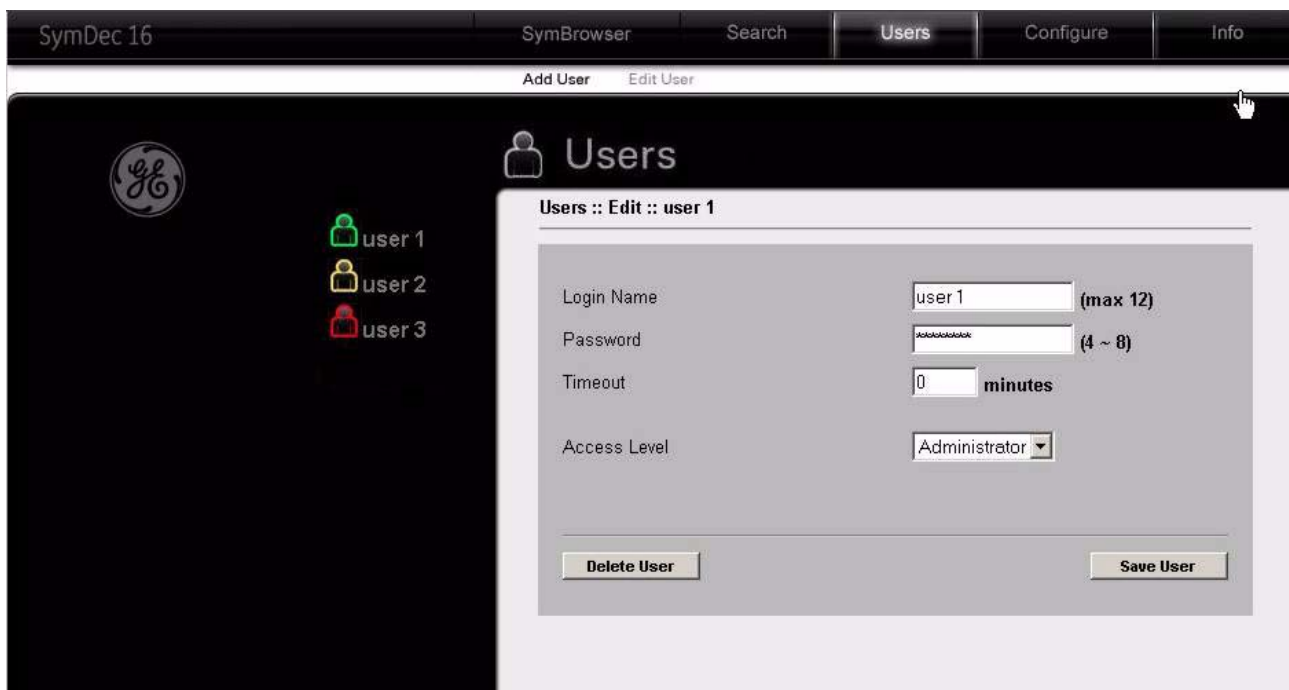

Configure options

Clicking on the *Configure* link will display the following options:

- Cameras
- Schedule
- Alarms
- Network
- System

Cameras

Click on the *Cameras* link to display the *Configure Cameras* page. Clicking on the camera that you want to configure launches the camera edit options:

- Recording
- Rates Duration
- Alarm Input
- Motion Detection
- Camera Title
- Adjust Video
- Copy Setting

Figure 68. Configure Camera page

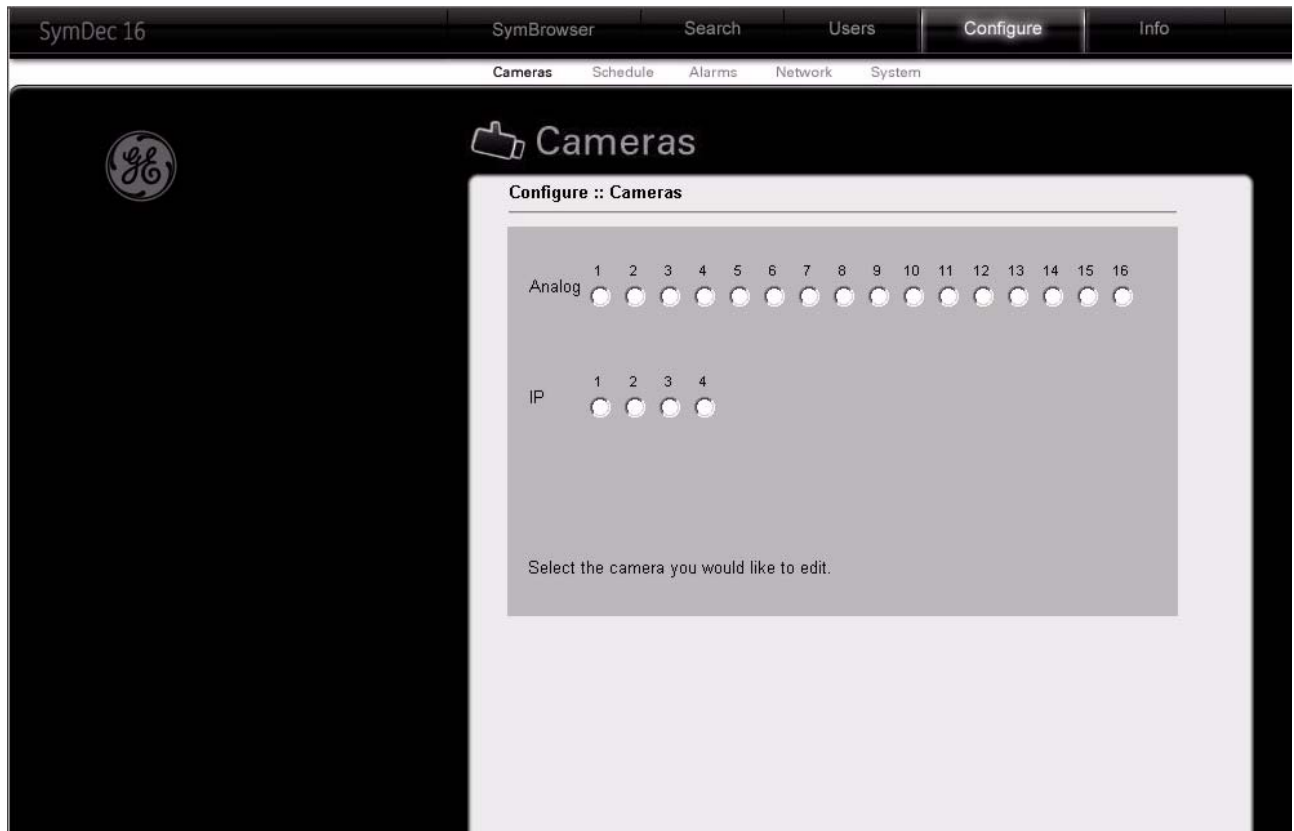

Recording

See the [Recording Menu](#) on page 36 for more detailed information on the features.

Figure 69. Cameras edit/recording page

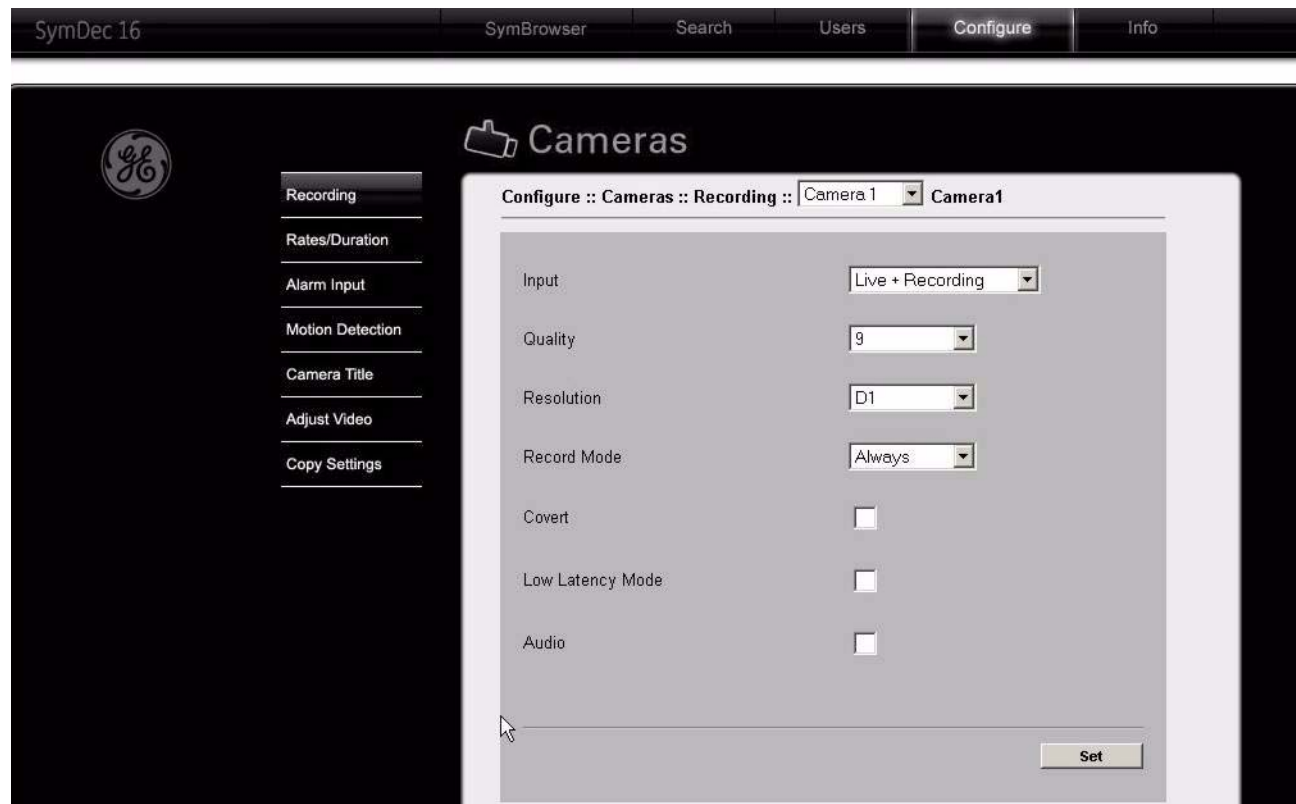

Rates/Duration

See [Duration Rates](#) on page 37 or more detailed information on the features.

Figure 70. Camera edit/Rates Duration page

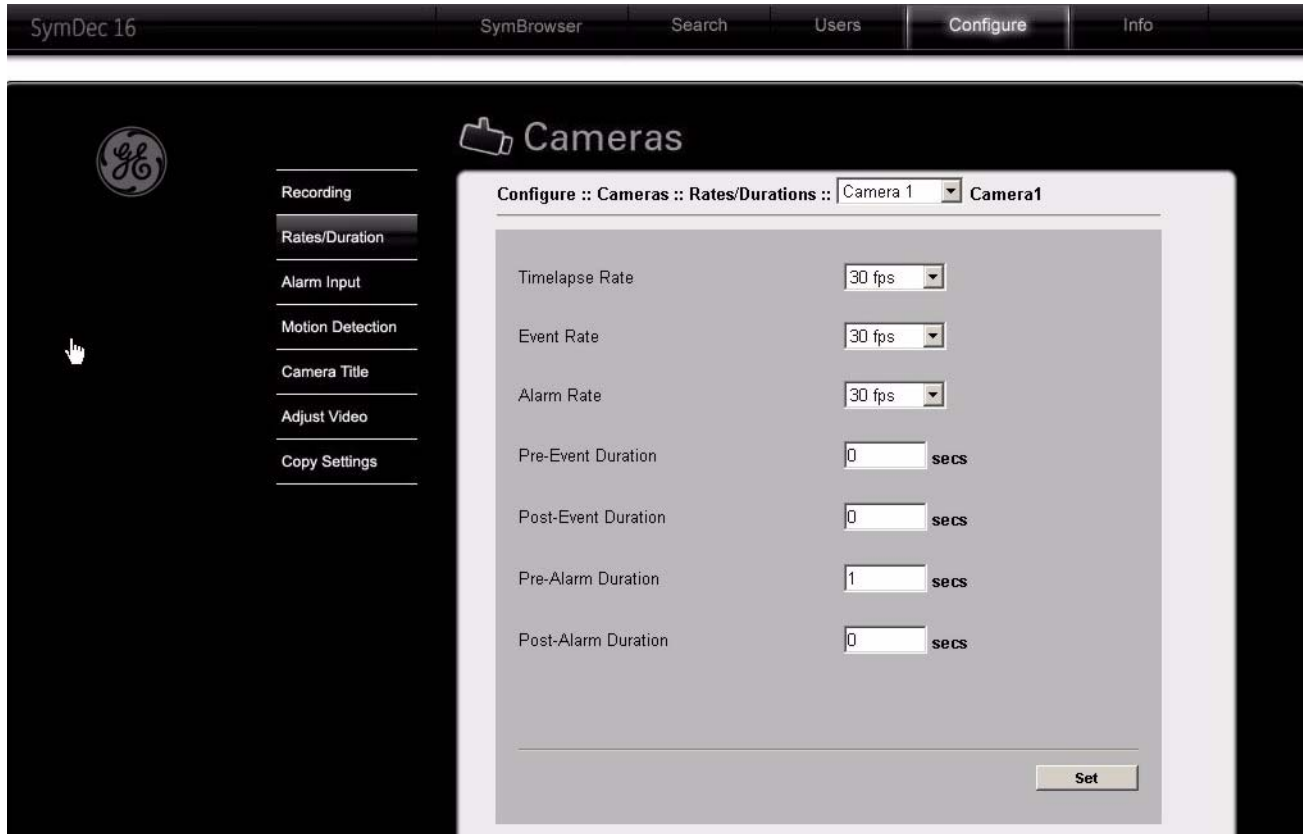

Alarm Input

See [Alarm Input](#) on page 38 for more detailed information on the features.

Figure 71. Camera edit/Alarm Input page

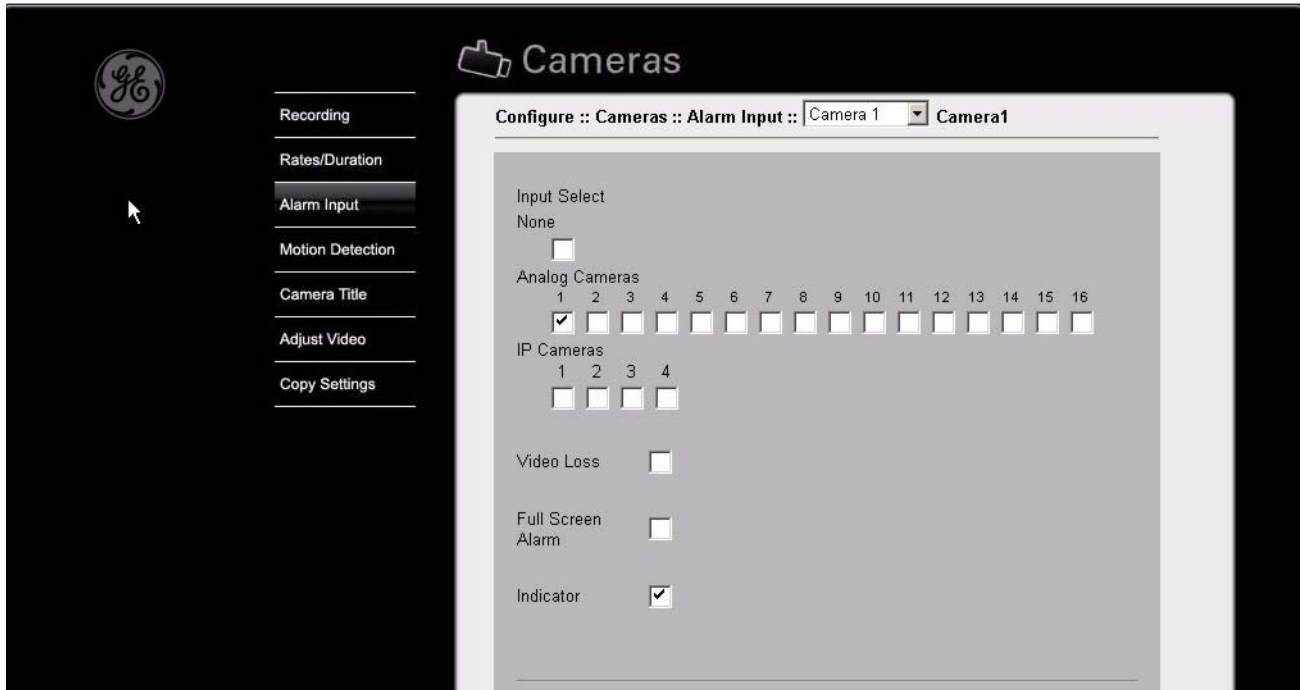

Motion Detection

See [Motion Detection](#) on page 39 for more detailed information on the features.

Figure 72. Camera edit/Motion Detection page

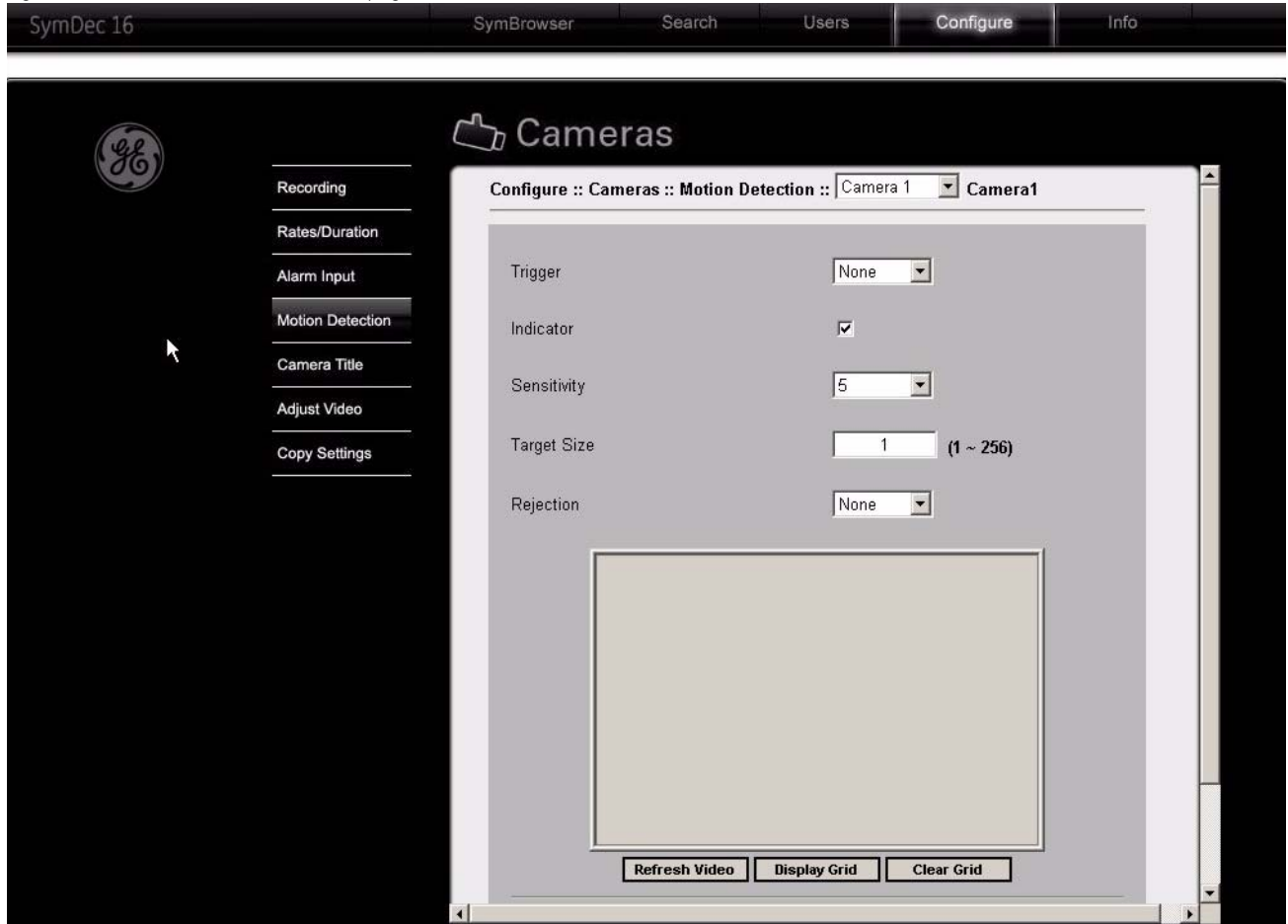

Camera Title

See [Camera Title](#) on page 40 for more detailed information on the features.

Figure 73. Camera edit/Camera Title page



Adjust Video

See [Adjust Video](#) on page 41 for more detailed information on the features.

Figure 74. Camera edit/Adjust video page

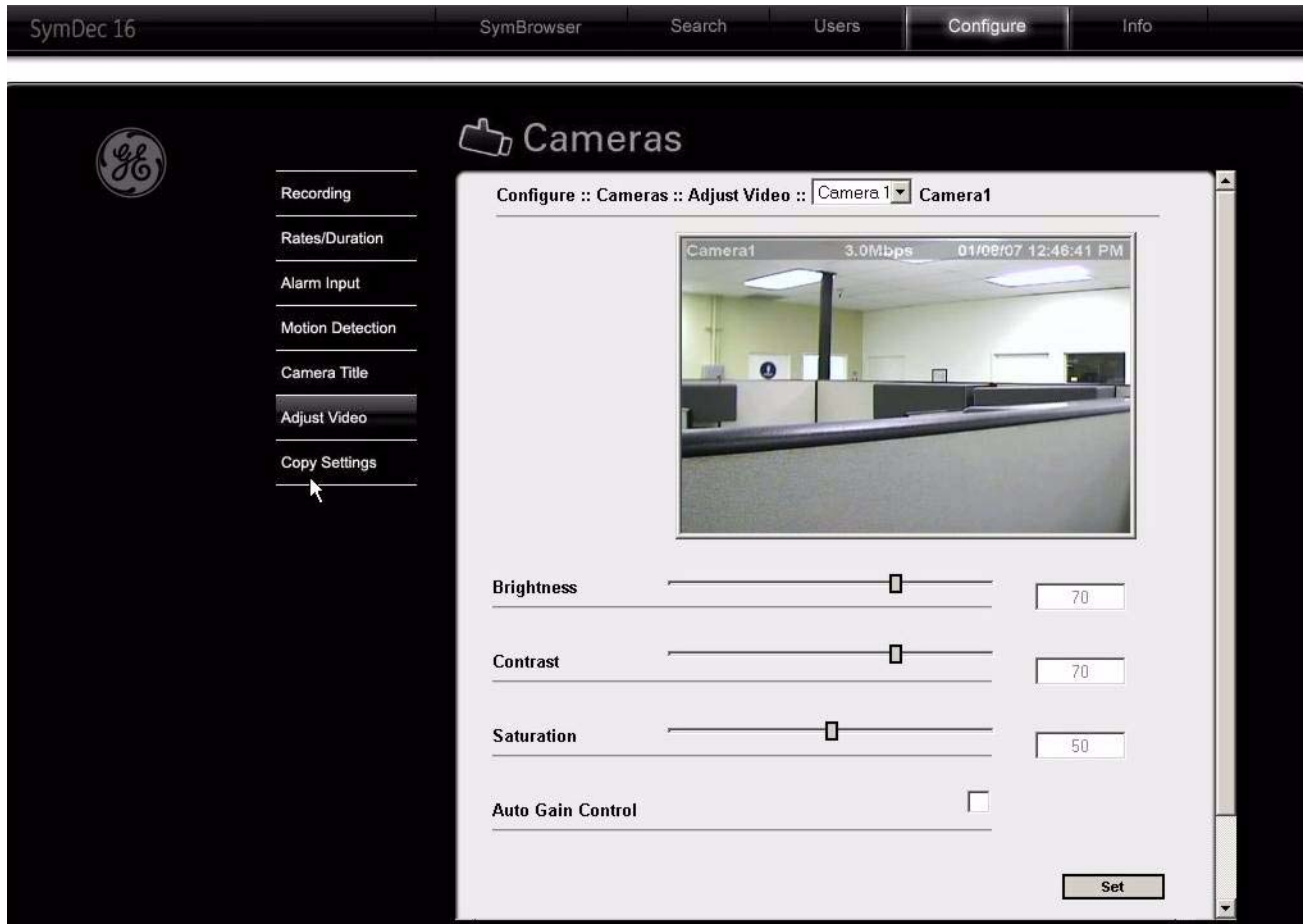

Copy Settings

See [Copy Settings](#) on page 42 for more detailed information on the features.

Figure 75. Camera Edit/Copy settings page

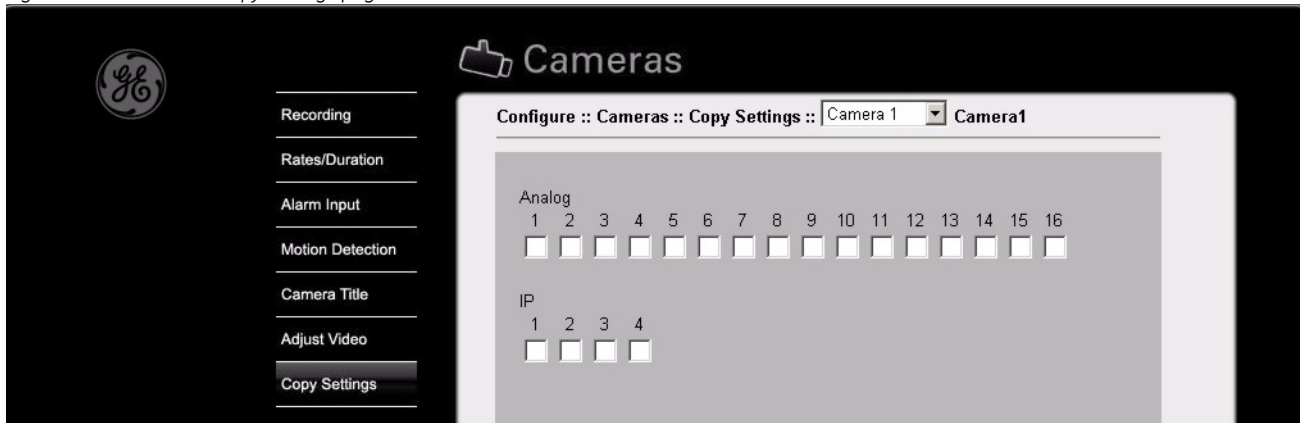

Schedule

Click on the *Schedule* link to display the following scheduling options:

- Schedule
- Macros
- Front Panel

Schedule

See [New Schedule](#) on page 48 for more detailed information on the features.

Figure 76. Schedule page

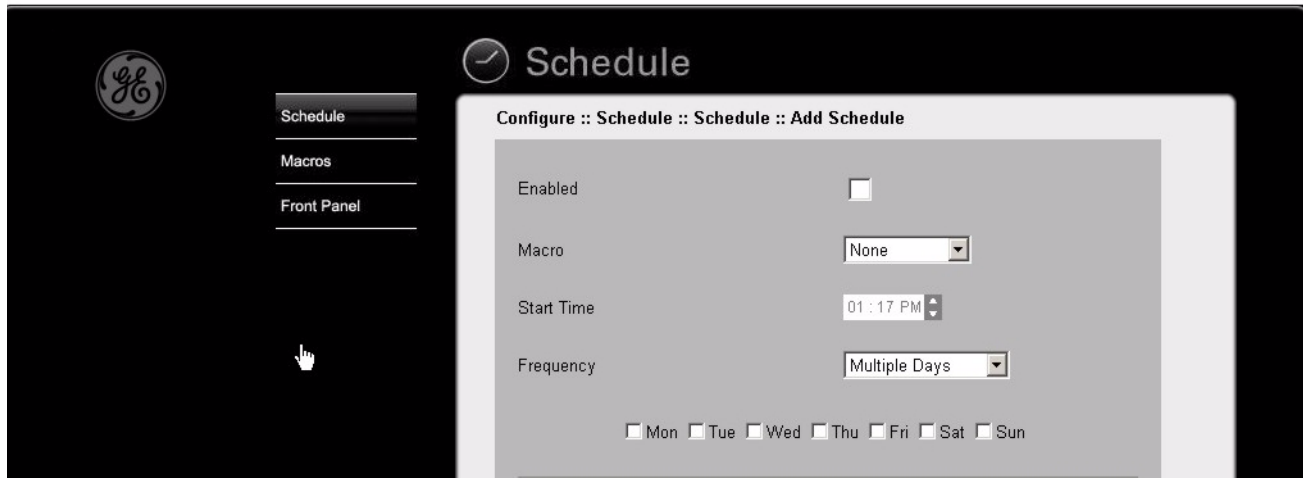

Macros

See [Macros](#) on page 49 for more detailed information on the features.

Figure 77. Macros page

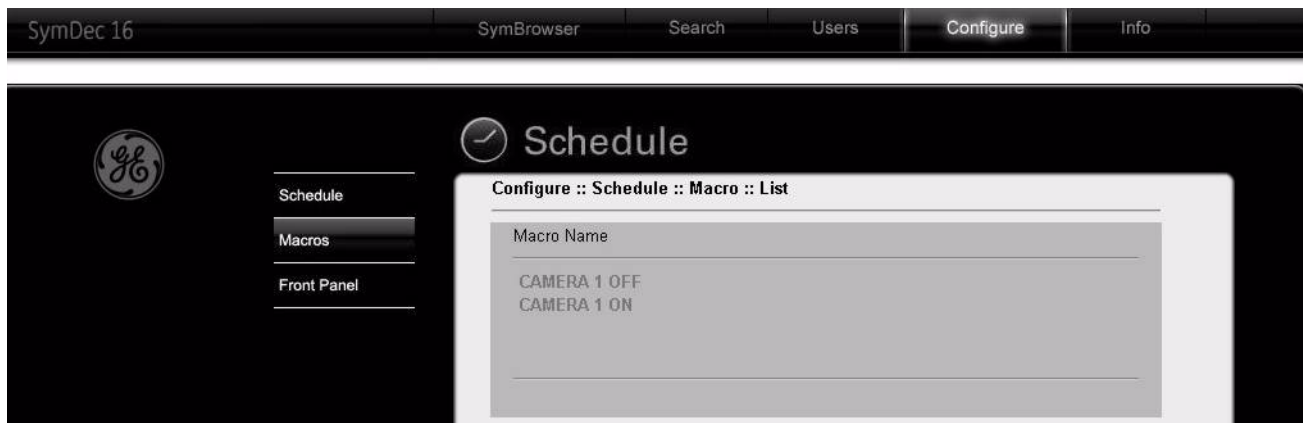

Front Panel

See [Front Panel](#) on page 52 for more detailed information on the features.

Figure 78. Front panel page

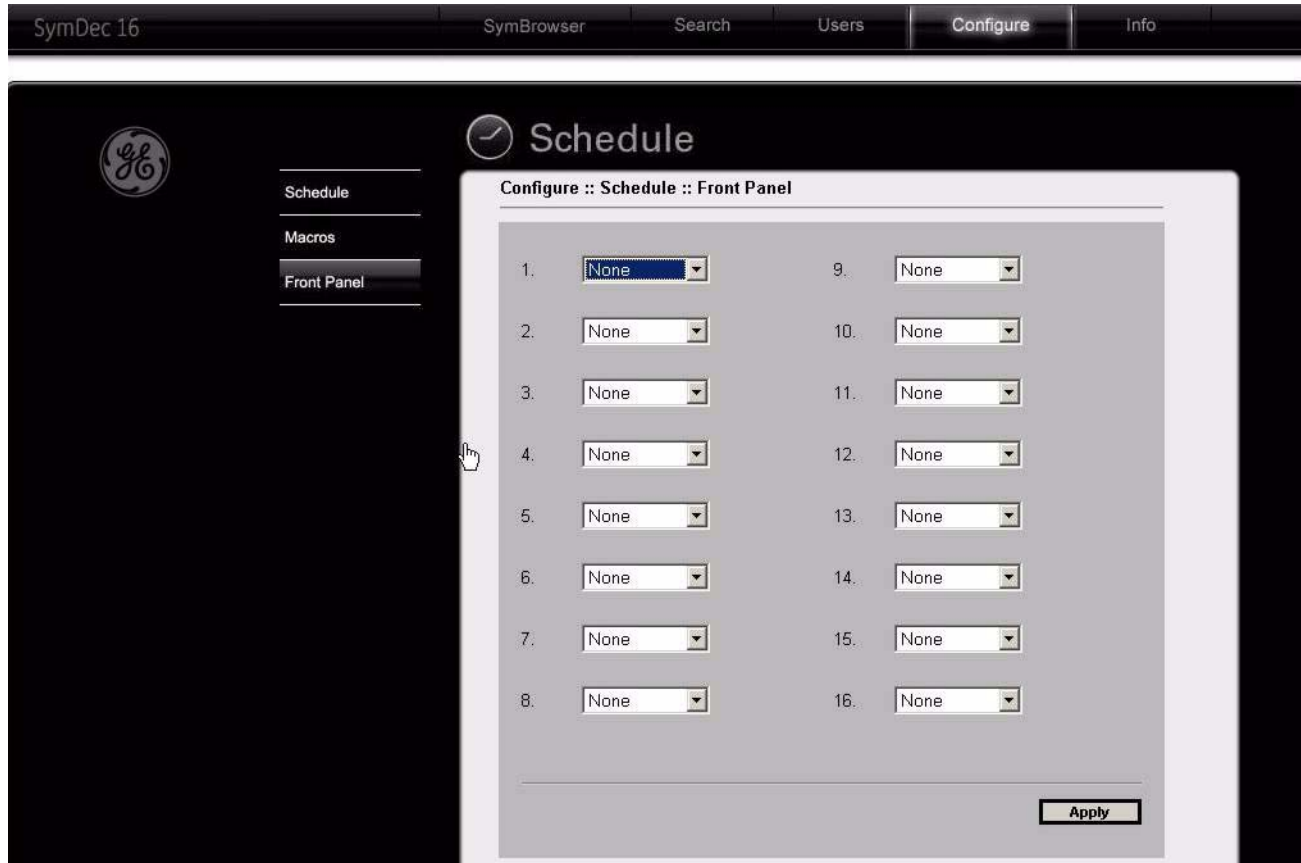

Silent Alarm

See on page 54 for more detailed information on the features.

Figure 80. Silent Alarm page



Alarm Inputs and Outputs

Figure 81. Alarm Inputs/Outputs page

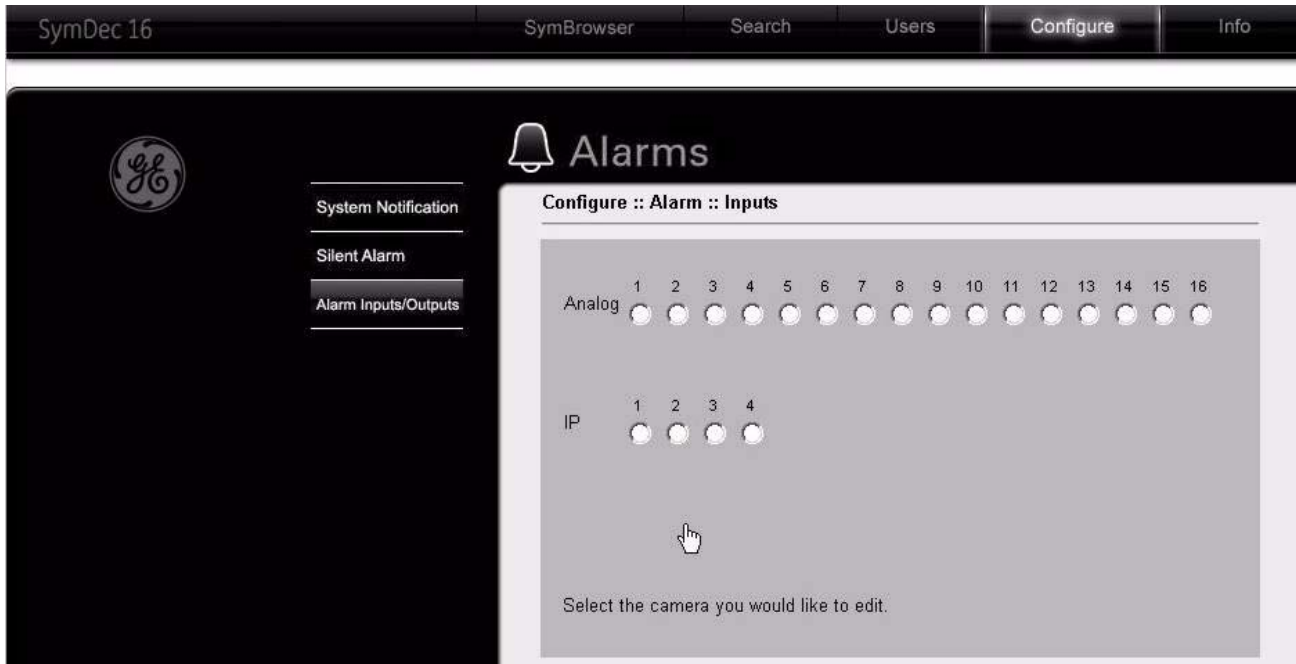

Select a camera number to launch the *Alarm Input/Outputs* edit page. See [Alarm Inputs and Outputs](#) on page 55 for more detailed information on the features.

Figure 82. The Alarms Inputs/Outputs edit page

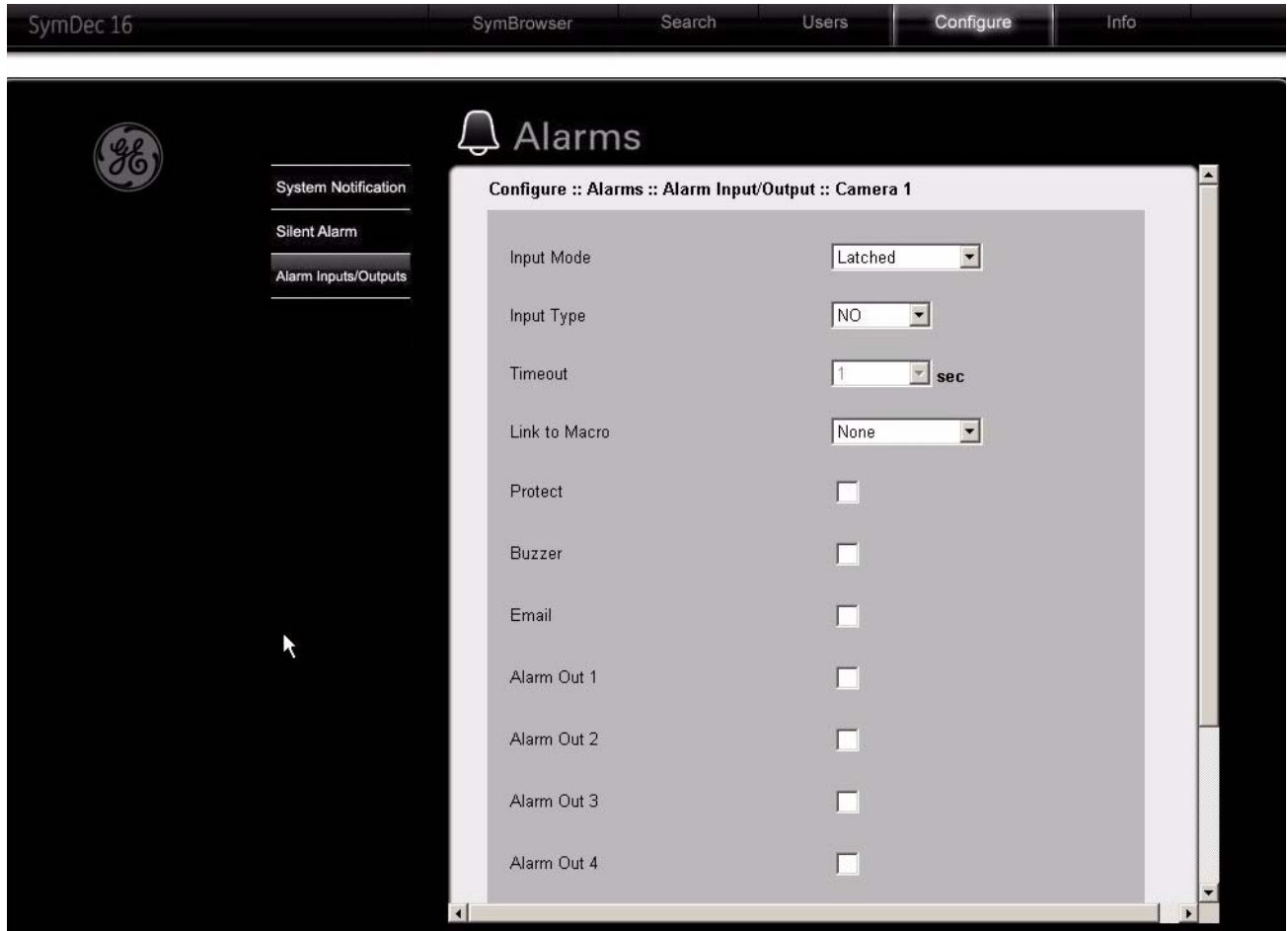

Network

Click on the *Network* link to display the following network options:

- IP Setting
- IP Advanced
- Services
- Streaming
- Serial Pass Through
- Network Notification
- Email Setup
- Notification Setup

IP Setting

See [IP Settings](#) on page 60 for more detailed information on the features.

Figure 83. IP Setting page

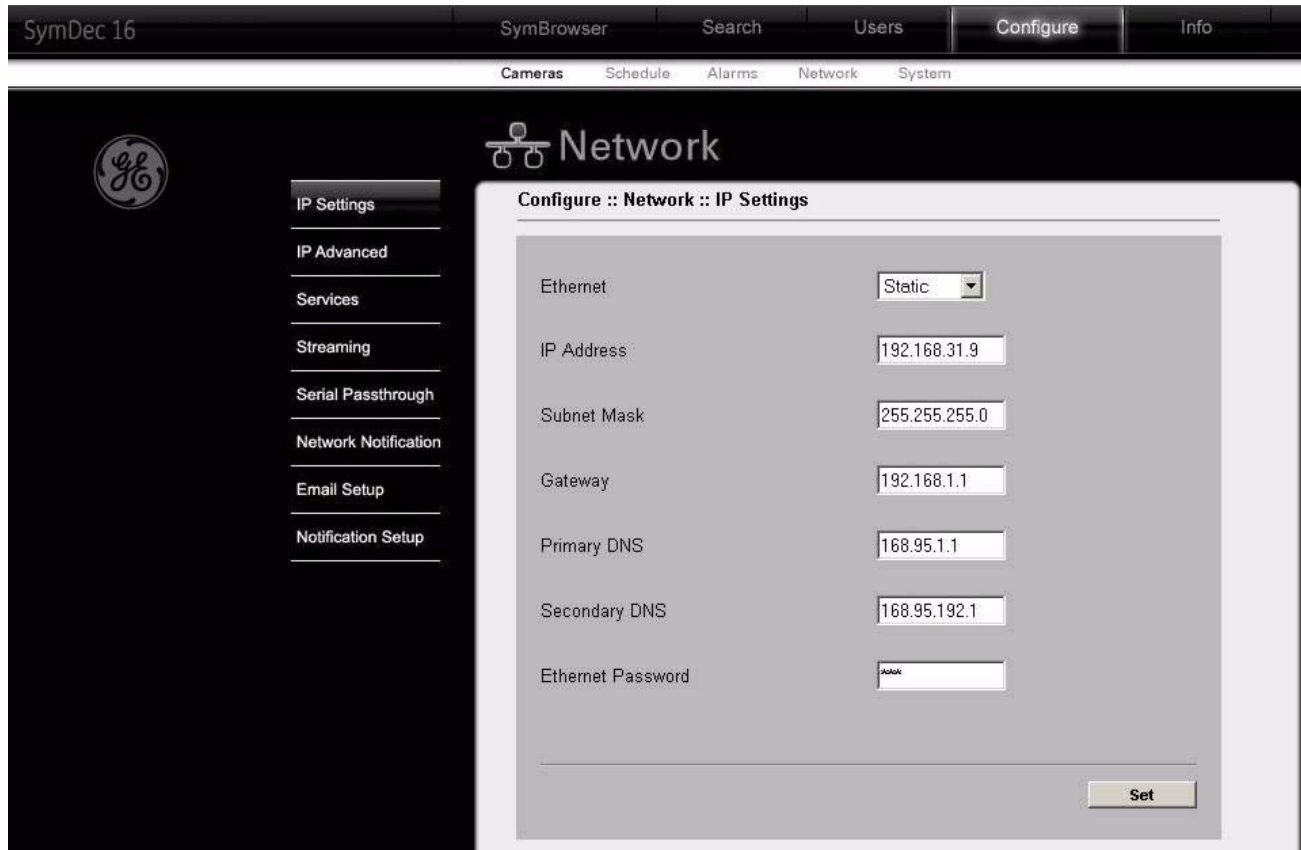

IP Advanced

See *IP Advanced* on page 61 for more detailed information on the features.

Figure 84. IP Advanced page

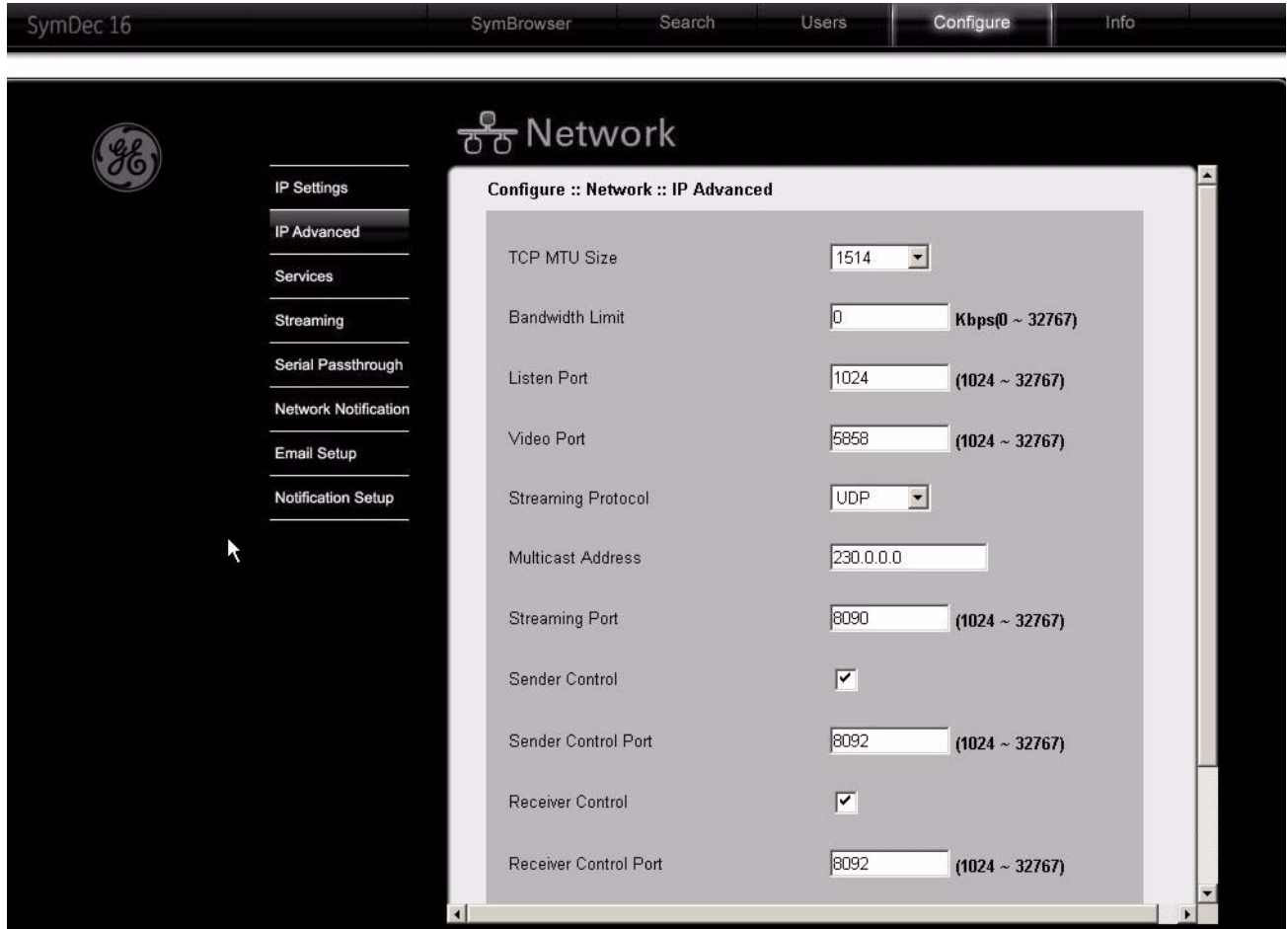

Services

See [Services](#) on page 63 for more detailed information on the features.

Figure 85. Services page

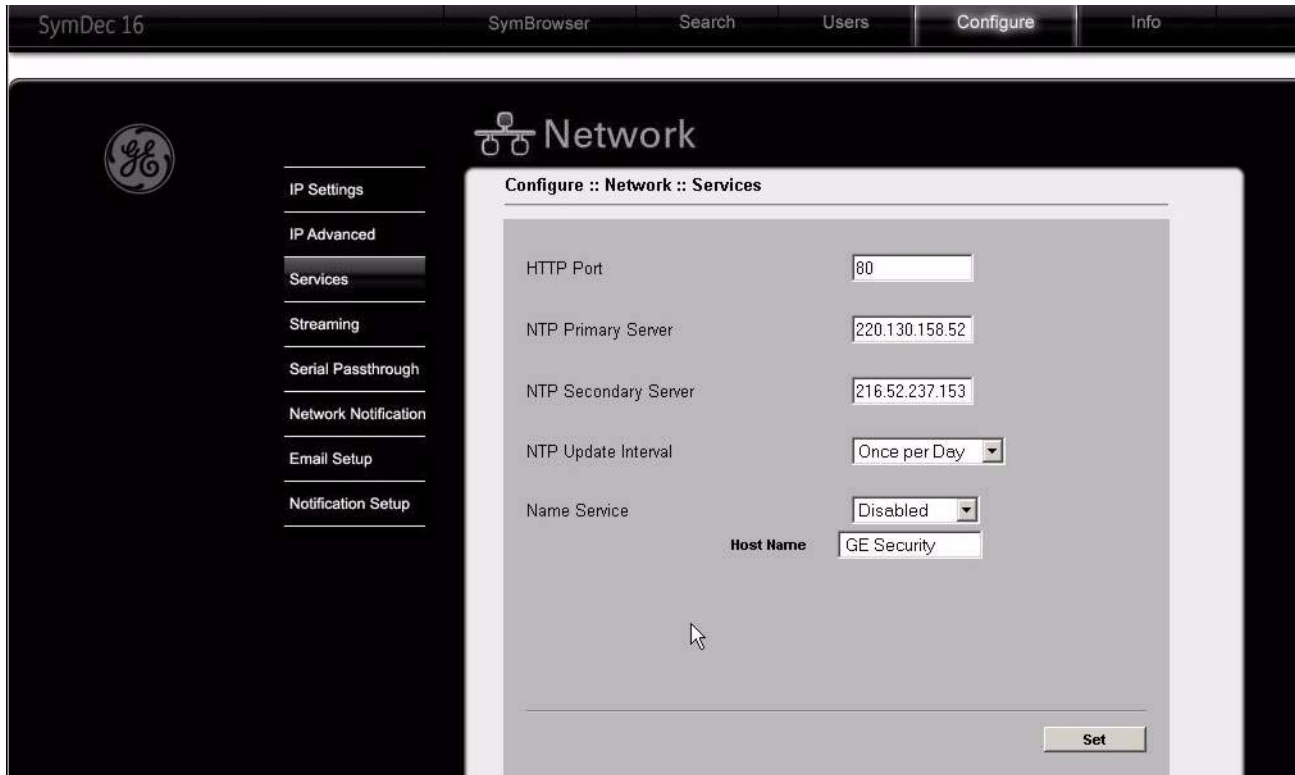

Streaming

See [Streaming](#) on page 64 for more detailed information on the features.

Figure 86. Streaming settings page

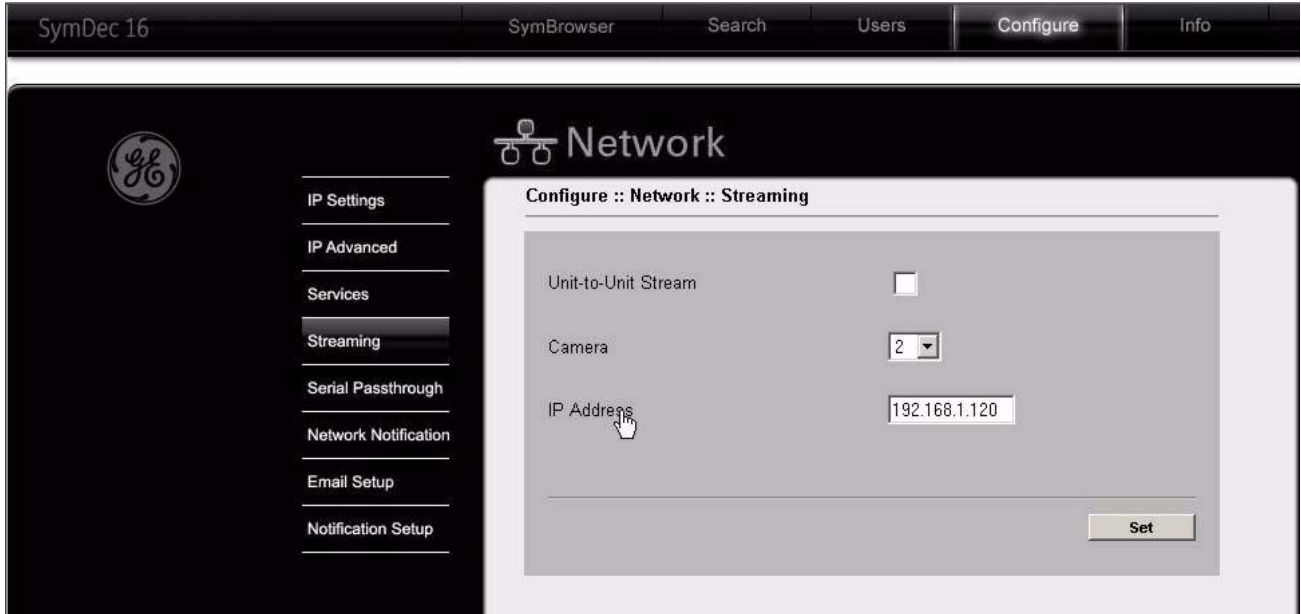

Serial Passthrough

See [Serial Passthrough](#) on page 65 for more detailed information on the features.

Figure 87. Serial pass through page

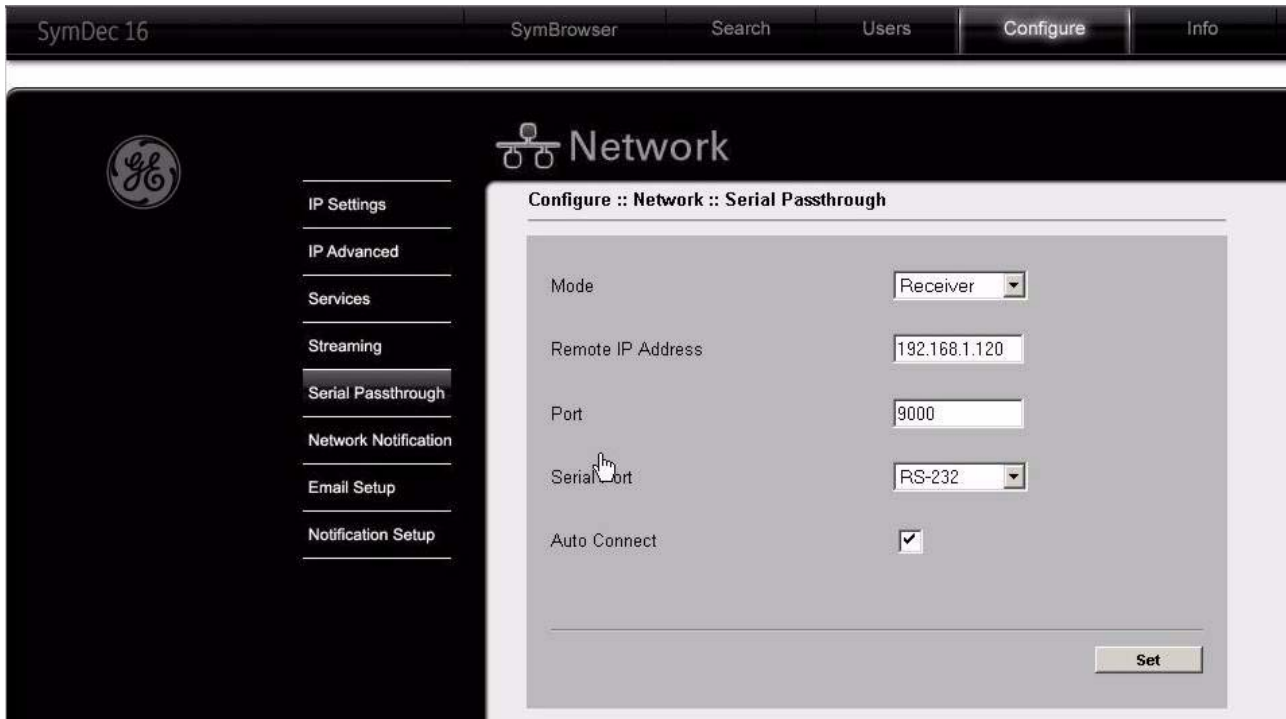

Network Notification

See [Email/TCP Notification](#) on page 66 for more detailed information on the features.

Figure 88. Network notification page

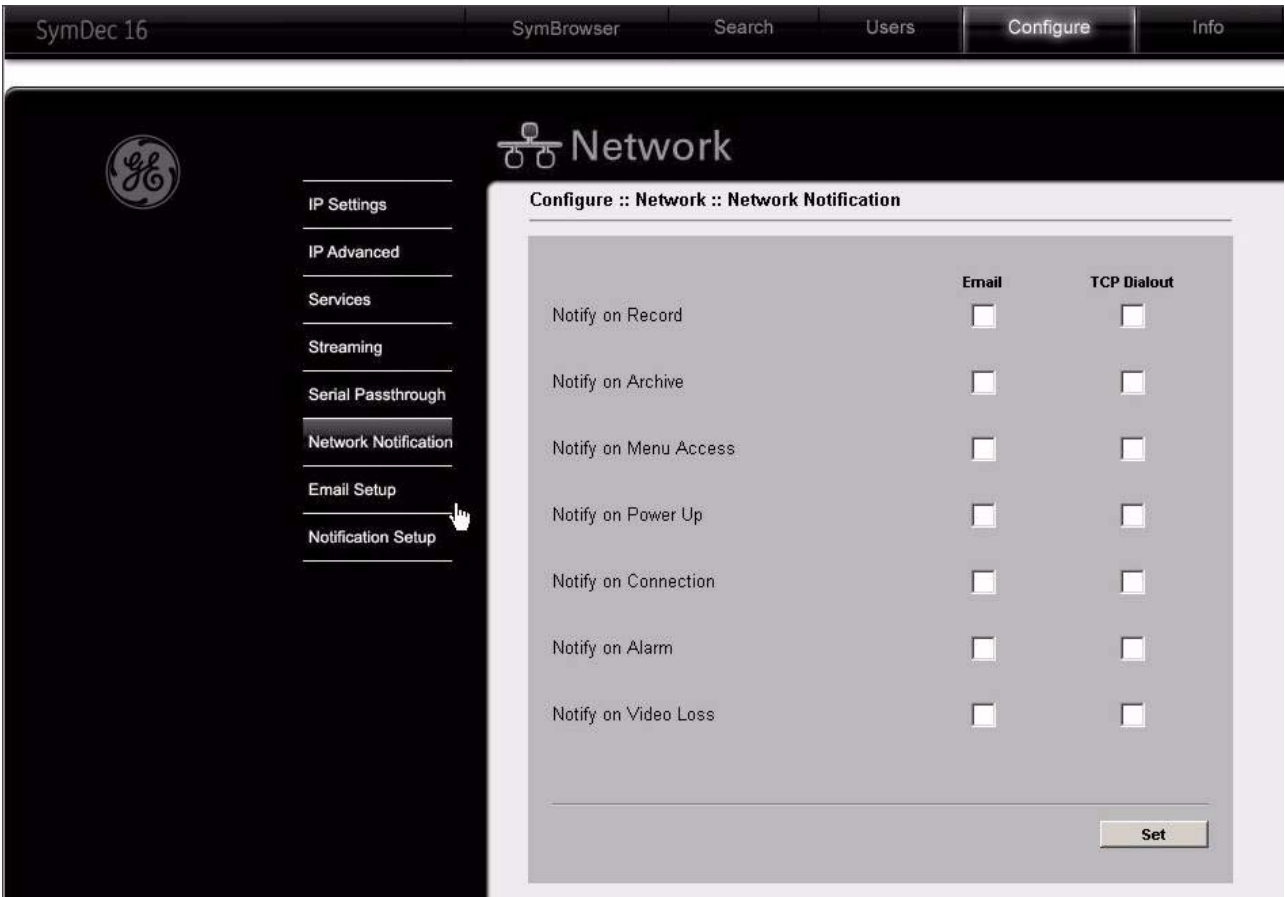

Email Setup

See [Email Setup](#) on page 67 for more detailed information on the features.

Figure 89. Email setup page

The screenshot shows the SymNav web interface. At the top, there is a navigation bar with tabs for 'SymDec 16', 'SymBrowser', 'Search', 'Users', 'Configure', and 'Info'. The main content area has a dark background with the GE logo on the left and a 'Network' header with a server icon. A sidebar on the left contains a menu with the following items: 'IP Settings', 'IP Advanced', 'Services', 'Streaming', 'Serial Passthrough', 'Network Notification', 'Email Setup' (which is highlighted), and 'Notification Setup'. The main content area displays a configuration window titled 'Configure :: Network :: Email Setup'. This window contains the following fields and options:

- Email Address #1:
- Email Address #2:
- Email Address #3:
- SMTP Server:
- SMTP Port:
- SMTP Authentication:
- SMTP Username:
- SMTP Password:
- SMTP SSL Enable:

A 'Set' button is located at the bottom right of the configuration window.

Notification Setup

See [Notification Setup](#) on page 68 for more detailed information on the features.

Figure 90. Notification setup

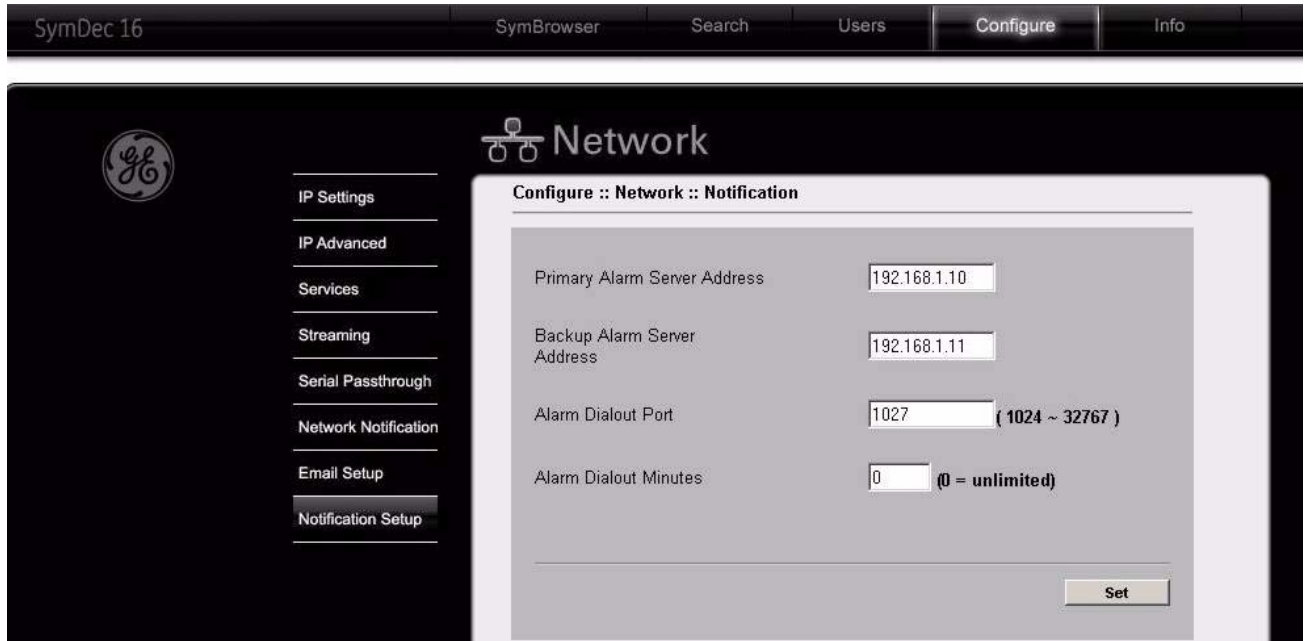

System

Click on the *System* link to display the following system options:

- Front Panel
- Time/Date
- Security
- Language
- Serial Communication

Front Panel

See [Front Panel](#) on page 70 for more detailed information on the features.

Figure 91. Front panel page

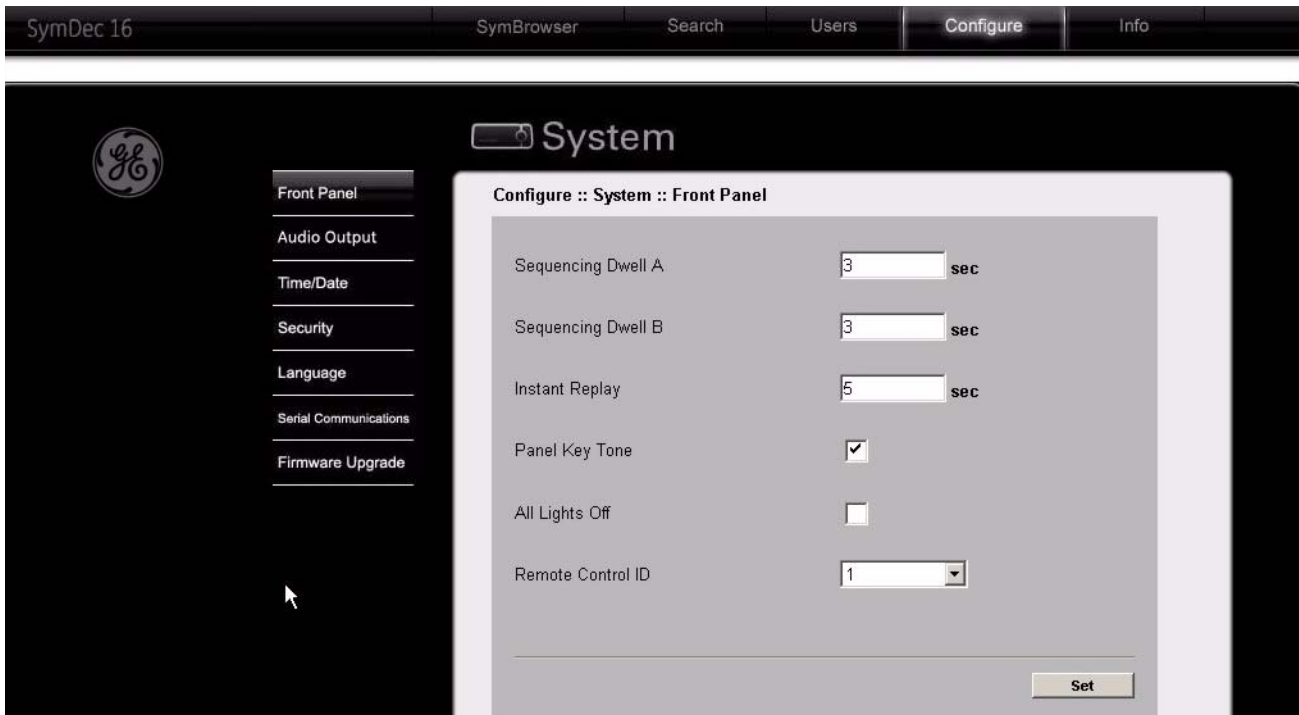

Audio Output

See [Audio Output](#) on page 71 for more detailed information.

Figure 92. Audio Output page



Time/Date

See [Time/Date](#) on page 72 for more detailed information on the features.

Figure 93. Time/Date page

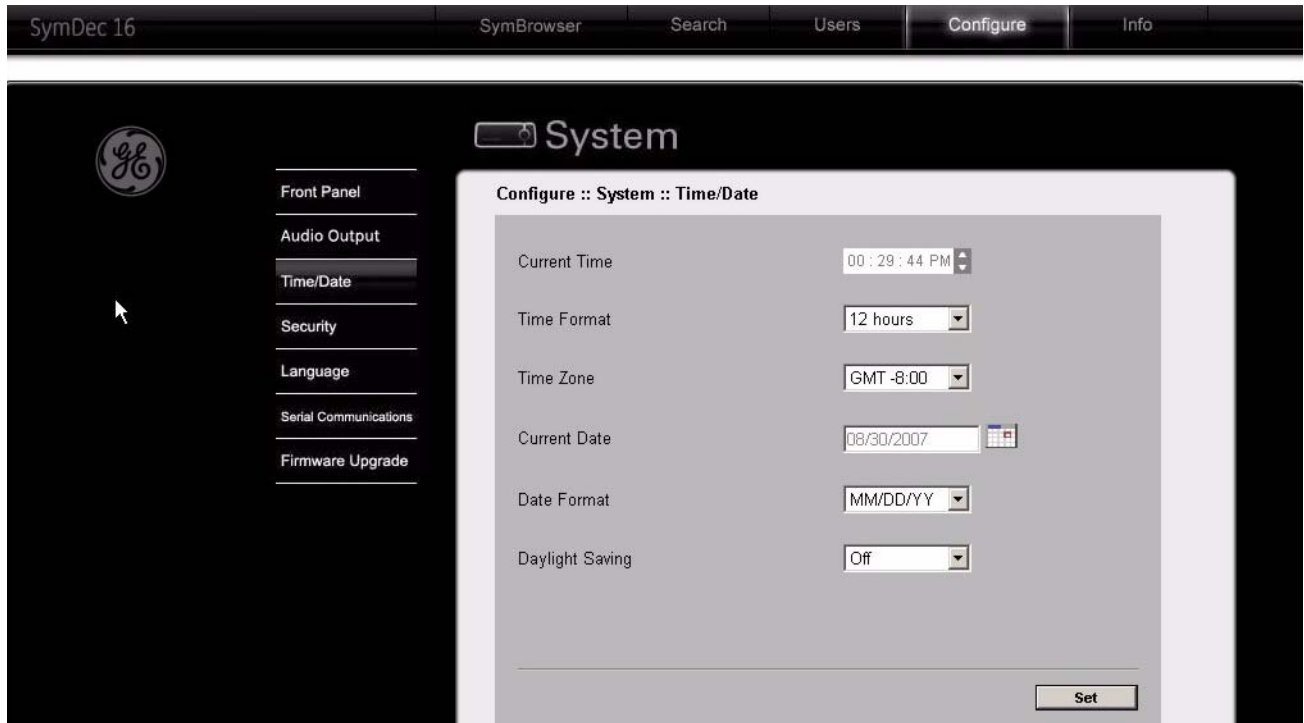

Security

See [Security](#) on page 74 for more detailed information on the features.

Figure 94. Security page



Language

See [Languages](#) on page 75 for more detailed information on the features.

Figure 95. Language page



Serial Communication

See *Serial Communications* on page 78 for more detailed information on the features.

Figure 96. Shutdown page

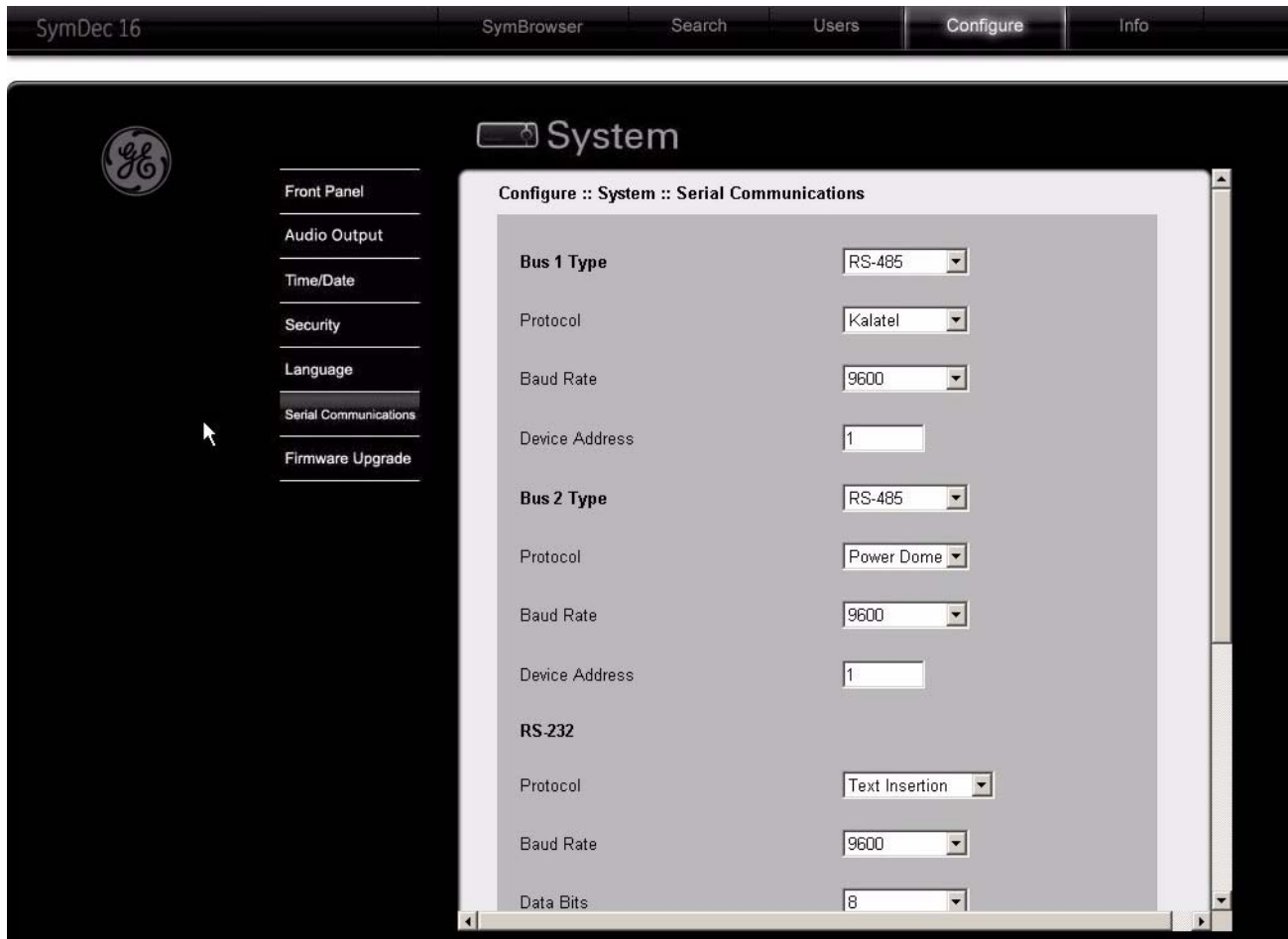

Firmware Upgrade

See [Firmware Upgrade](#) on page 80 for more detailed information.

Figure 97. Firmware Upgrade page

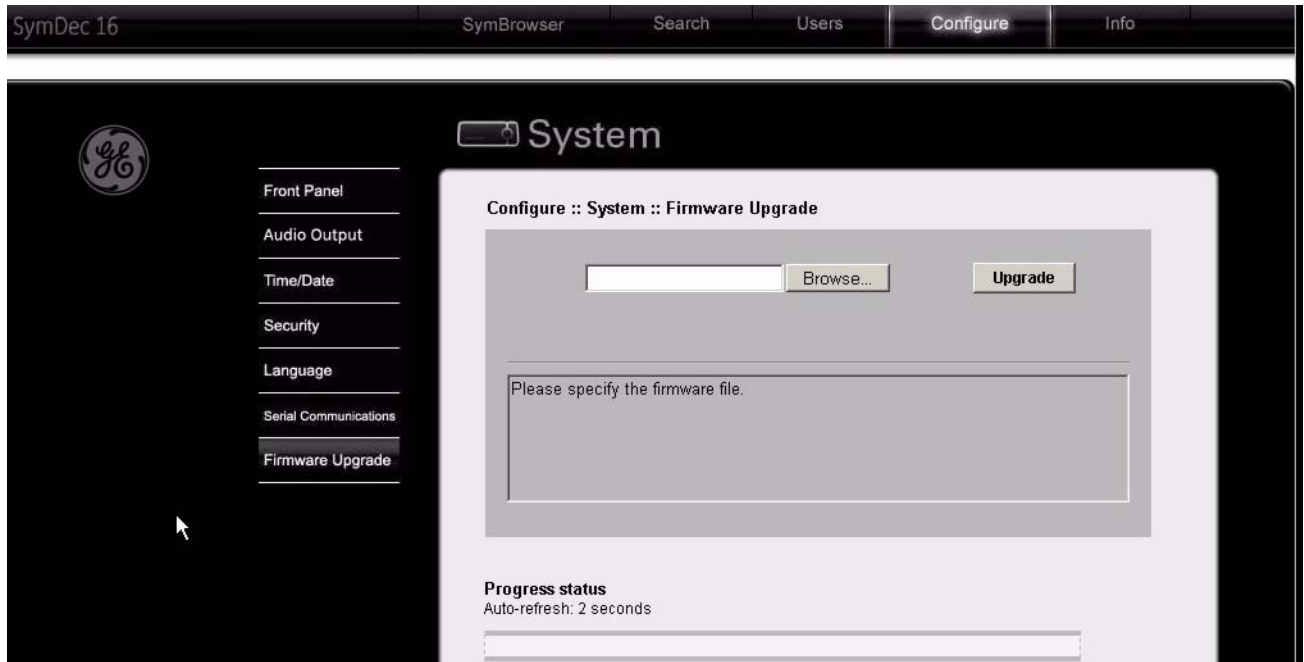

Info

Clicking on the *Info* link will display system and network information.

- System
- Network
- Log

System

Figure 98. About system page

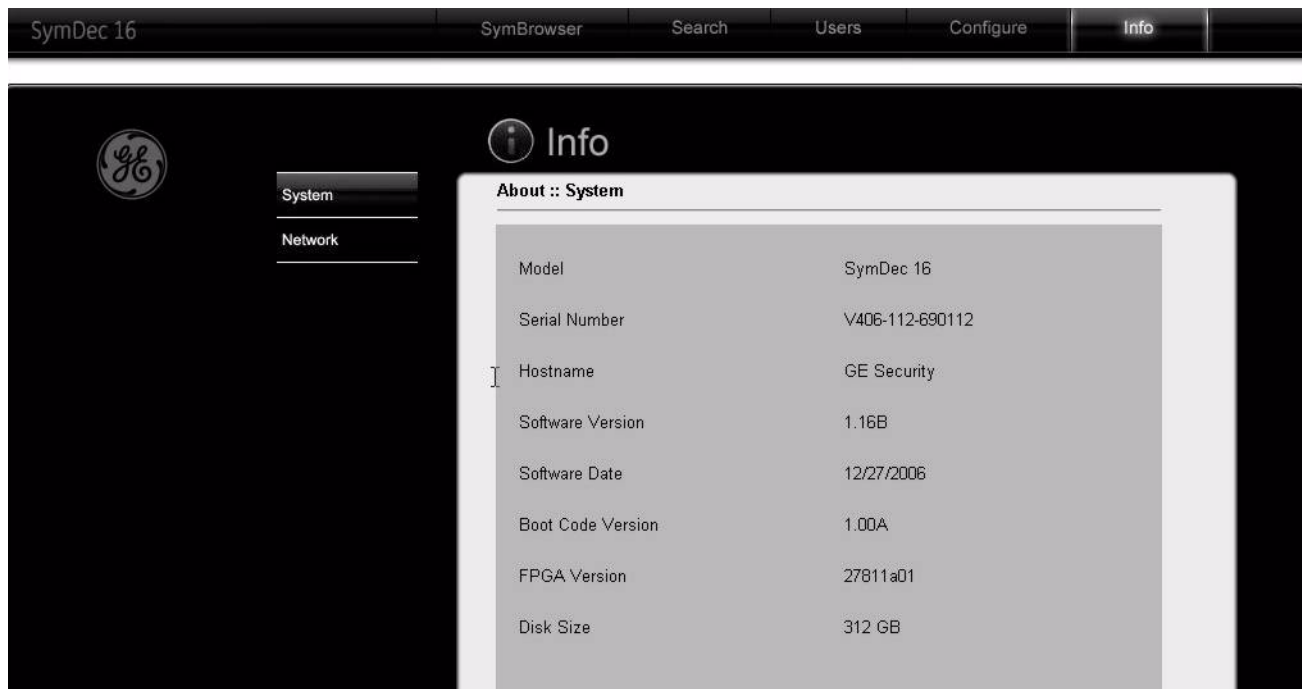

The screenshot shows the SymNav interface. At the top, a navigation bar contains 'SymDec 16', 'SymBrowser', 'Search', 'Users', 'Configure', and 'Info'. The 'Info' link is selected. Below the navigation bar, the GE logo is on the left, and a sidebar contains 'System' and 'Network' links. The main content area is titled 'Info' and displays 'About :: System' information in a table format.

About :: System	
Model	SymDec 16
Serial Number	V406-112-690112
Hostname	GE Security
Software Version	1.16B
Software Date	12/27/2006
Boot Code Version	1.00A
FPGA Version	27811a01
Disk Size	312 GB

Network

Figure 99. About network page

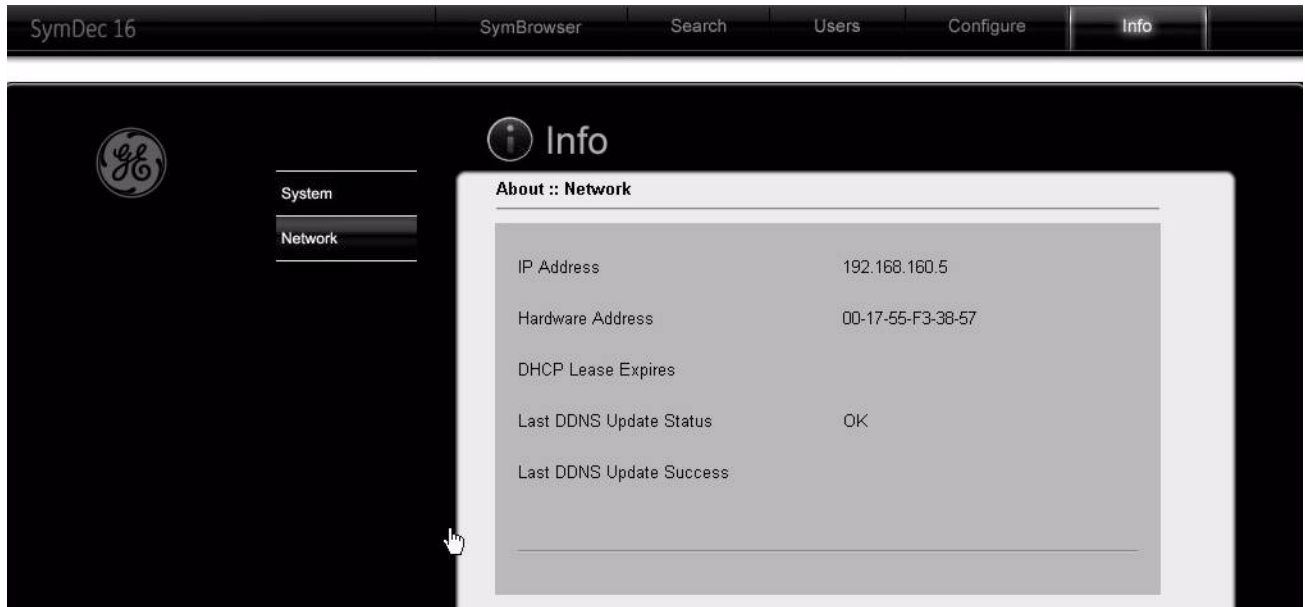

Log

Figure 100. About log page



Symbrowser

The SymBrowser screen provides you access to live and recorded video without the need for additional software. Simply click on the *SymBrowser* link. The following features are available:

- Right-click on the video to switch from live or playback mode or view full-screen.
- High and Low bandwidth buttons (High is best with PTZ cameras)
- Live button
- Frame advance forward and reverse button
- Replay button
- Fast reverse playback button
- Reverse playback button
- pause button
- Play button
- Fast play forward button
- Analog/IP camera select button
- Camera buttons (1-16 analog, 1-4 IP)

Figure 101. The SymBrowser screen

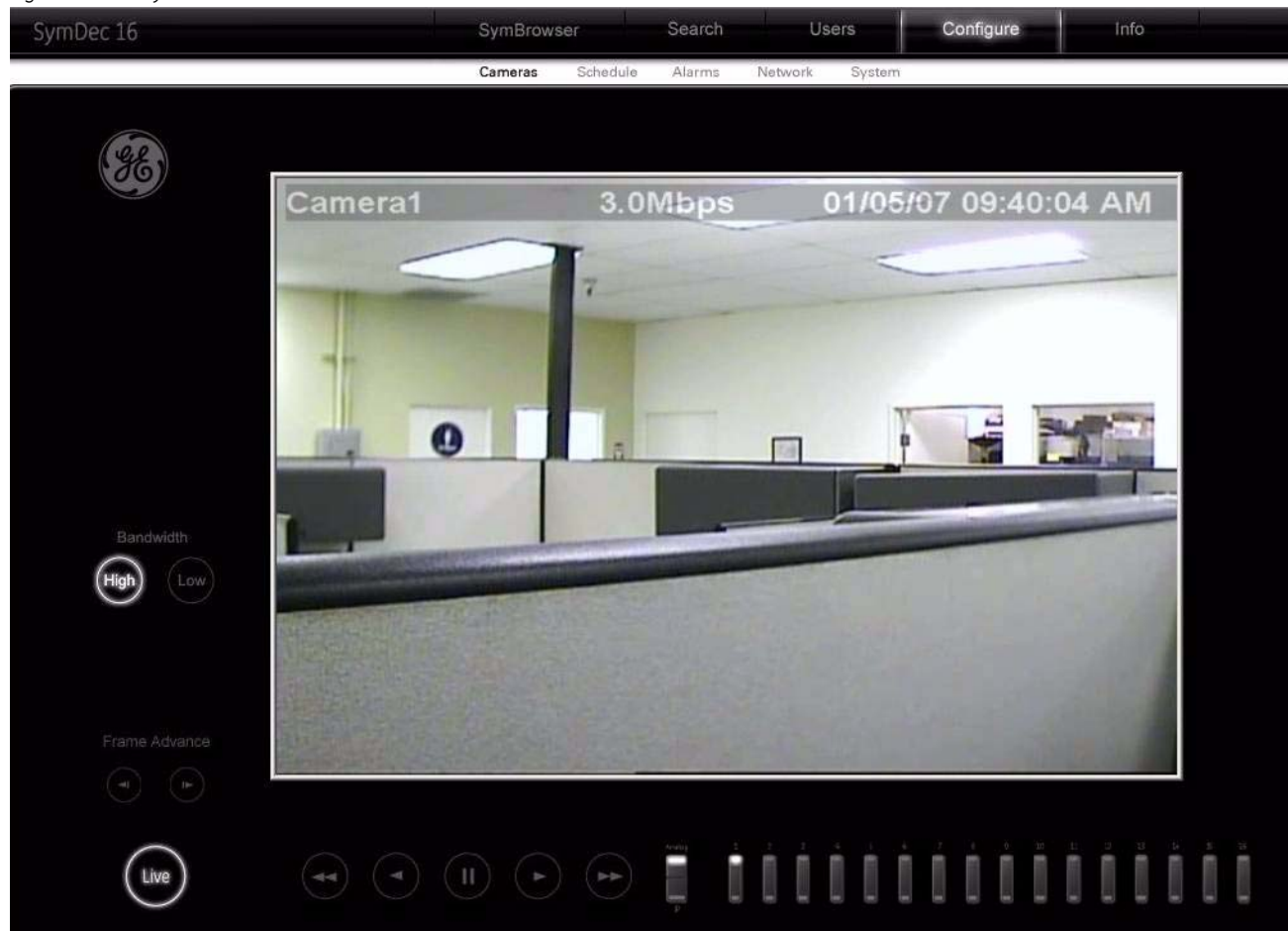

Chapter 6 Searching and Archiving

This chapter provides an in-depth explanation of the SymDec 16's *Searching* and *Archiving features*

In this chapter:

- Searching* 126
 - The Disk Analysis Screen* 126
 - Search Filters* 127
 - Date and Time Search* 127
 - Camera Motion Search* 128
 - Daily Hours Search* 128
 - Search For Search* 129
 - Search Results* 130
- Archiving* 131
 - Fullscreen Search Results Preview* 132
 - SymPlayer* 133

Searching

Press the *Search* button on the front panel to launch the *Search* menus. The first screen to display is the *Disk Analysis Screen*.

The Disk Analysis Screen

The Disk Analysis screen provides a graphical view of the video stored on the hard drive. The *Enter* button moves you into the Disk Analysis focus window. When first loaded Disk Analysis shows all the video currently stored on the hard drive. The scale is determined dynamically. The timeline flows from left (oldest) to right (newest) video.

In the Disk Analysis pane, UP and DOWN will zoom the view in and out. LEFT and RIGHT will move the cursor. The window is divided horizontally into 48 equal slices. Holding down LEFT and RIGHT will jump the cursor back and forth to the next nearest slice in that direction. Additional behaviors include:

- LEFT from far left scrolls left a half screen if more video is available, centering the cursor, else the cursor remains at the left end of the video.
- RIGHT from far right scrolls right a half screen if more video is available, centering the cursor, else the cursor remains at the right end of the video.

Zoom is intended to allow video ranges from 1 year to 10 seconds within seven levels of zoom.

- Zoom In expands the two slices to the left and right of the cursor to the fullpane.
- Zoom Out reduces the current full screen to four slices centered in the middle.

Holding LEFT or RIGHT should act as repeated presses. ENTER will begin playback at current play marker.

Figure 102. The Disk Analysis Screen

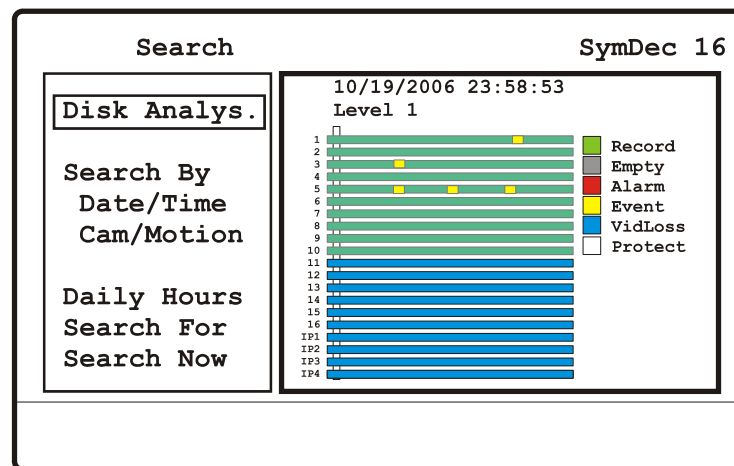

Search Filters

Search by Dates/Time, *Cameras/Motion*, *Daily Hours* and *Search For* are all filters which help to narrow the results the user is presented with when performing a search. The results are then derived at the intersection of all of the filters. If any one filter extends beyond the range of any other (such as daily hours being outside the Search by Dates range selected), the results should not be negatively effected as the intersection will still be within the smaller of the two spaces.

Date and Time Search

Select *Search by Date/Time* to launch the Date Time Search menu. Menu options include:

- All Dates
- Last x days (x = number)
- Last x hours
- Start/Stop

Figure 103. Search by Date and Time screen

Search	SymDec 16
Disk Analys.	Date Search
Search By	Start/Stop
Date/Time	Start: 10/12/2006
Cam/Motion	19:53:07
Daily Hours	Stop: 10/12/2006
Search For	19:54:07
Search Now	

Camera Motion Search

Select *Search by Cam/Motion* to launch the Cam/Motion Search menu. Menu options include:

- All cameras
- Motion Detection
- Select by Camera

Figure 104. Search by Camera Motion screen

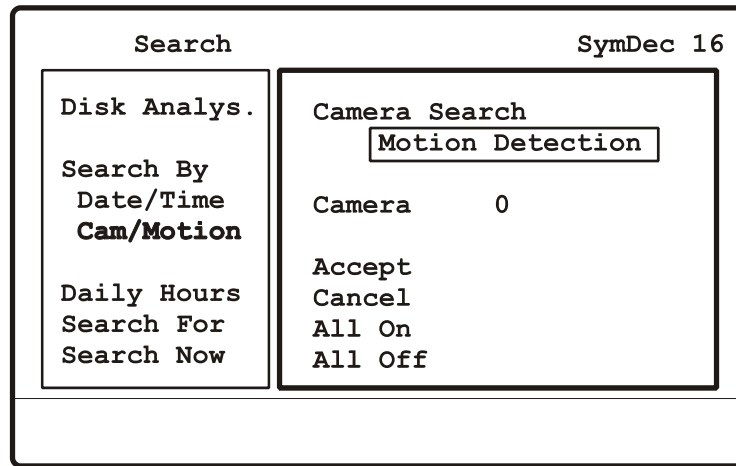

Daily Hours Search

Select *Search by Daily Hours* to launch the Daily Hours Search menu. This option searches *All Hours*.

Figure 105. Search by Daily Hours screen

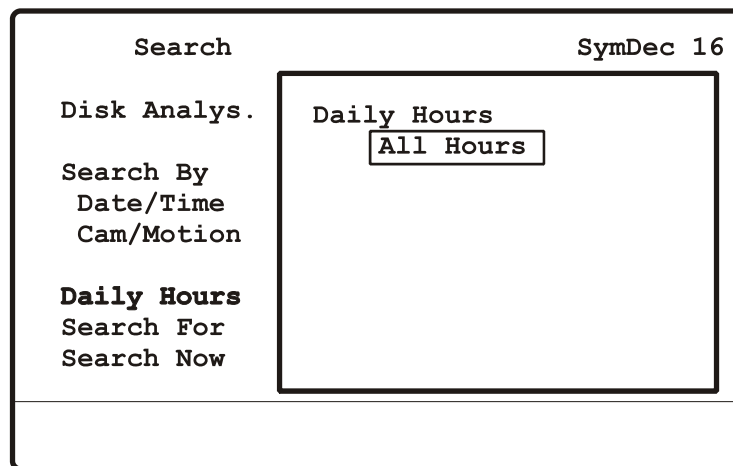

Search For Search

Select *Search by Search For* to launch the Search For Search menu. Menu options include:

- All Items
- Text: launches on-screen keypad
- Alarms + Events
- Alarms Only

Figure 106. Search For screen

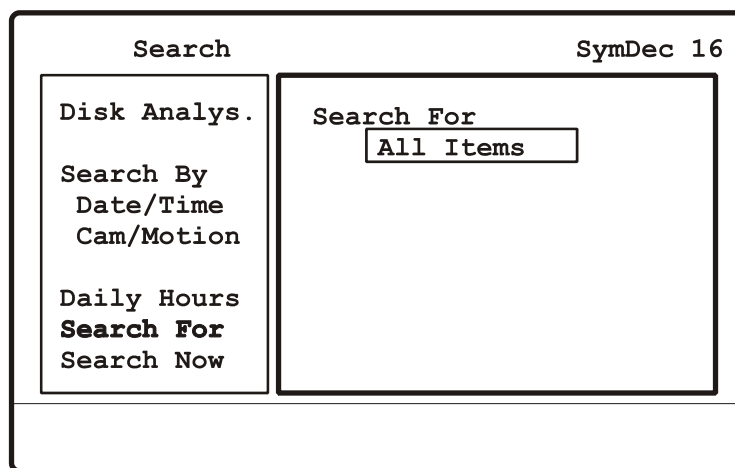

Search Results

Select the *Search Now* command and press the *Enter* button to launch the Search Results screen. Results are ordered by date, oldest first. Default selection is: Play of the top left thumbnail. Use the *arrow* buttons to move you through the selection of the thumbnails. Arrow indicators on the top and bottom are used to indicate that there are additional video segments on other screens. Press *enter* on any thumbnail to go to full screen preview and press the *enter button* to start playback.

Figure 107. Search Results screen

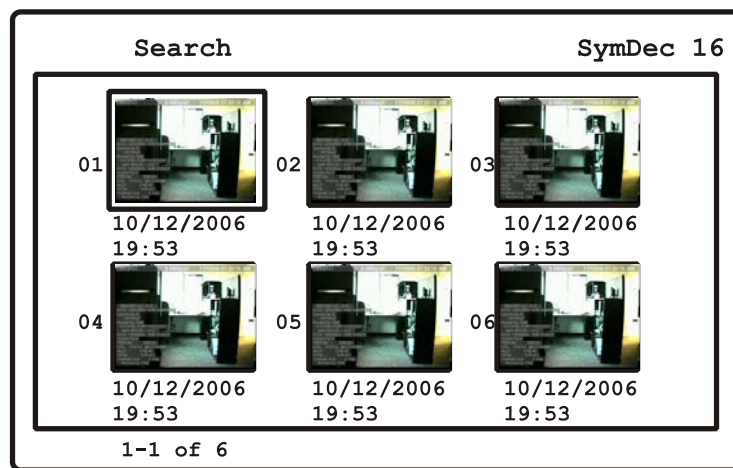

Archiving

Press the *Archive* button to launch the Archive screen. Menu options include:

- Archive Media - DVD or USB device
- Archive Name - Launches on-screen keypad
- Archive Length - In minutes
- Include Video Player - Yes or No
- Camera Selection boxes
- Size - In megabytes
- Start and Stop parameters
- All On - Selects all cameras
- All Off - Deselects all cameras
- Archive Now - Starts archiving to selected media

Figure 108. The Archive Screen

Archive		SymDec 16
Archive Media	<input type="text" value="Disc"/>	0000 MB
Archive Name	<input type="text" value="Are"/>	
Archive Length	<input type="text" value="1"/>	Minutes
Include Video Player	<input checked="" type="checkbox"/>	
Analog		Size :0000 MB
<input type="text" value="1"/> <input type="text" value="2"/> <input type="text" value="3"/> <input type="text" value="4"/> <input type="text" value="5"/> <input type="text" value="6"/> <input type="text" value="7"/> <input type="text" value="8"/>		Start:10/12/2006
<input type="text" value="9"/> <input type="text" value="10"/> <input type="text" value="11"/> <input type="text" value="12"/> <input type="text" value="13"/> <input type="text" value="14"/> <input type="text" value="15"/> <input type="text" value="16"/>		19:53:07
IP		Stop: 10/12/2006
<input type="text" value="1"/> <input type="text" value="2"/> <input type="text" value="3"/> <input type="text" value="4"/>		19:54:07
<input type="checkbox"/> All On	<input type="checkbox"/> All Off	<input type="button" value="Archive Now"/>
No Media Found		

**CAUTION**

Do not use CD/DVD's with paper labels attached to the surface of the CD/DVD. The label's surface may become damaged and cause the CD/DVD media to become stuck inside the DVD recorder.

Fullscreen Search Results Preview

The *Search Results Preview* screen hides the menu system and puts the user in full screen mode with the selected thumbnail. From *Disk Analysis*, Preview hides the menu system and puts the user in a 16 multiscreen display with all channels in playback. All transport controls affect the video.

Figure 109. Fullscreen search results preview screen

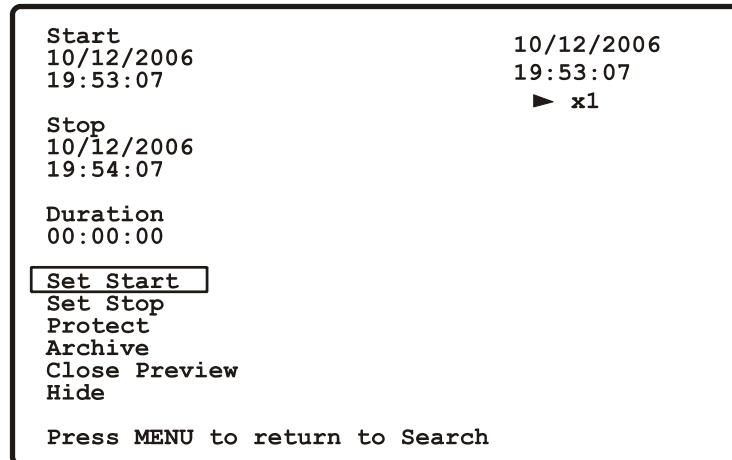

The following menu options are available on this screen:

- *Set Start* - marks the beginning of the video for archive purposes. The resulting start is shown in the summary
- *Set Stop* - marks the end of the video for archive purposes. The resulting stop is shown in the summary. If no stop is associated with the current video, the current date and time are used.
- *Protect* - prevents the selected video from deletion.
- *Archive* - brings up the Search Archive screen.
- *Close Preview* - exits preview and search and returns the user to the display screen from which they entered search.
- *Hide* - collapses the Start, Stop, Duration and Menu into a single Unhide button to make video review easier. Pressing Menu in Hide mode behaves the same when fully displayed.
- *Menu* - returns the user to the screen that brought him to preview, either Thumbnail or Disk Analysis. The user is returned to the same point (Zoom level and position in Disk Analysis or level in the Search results list from a Search) from which they entered Preview.

SymPlayer

Symplayer launches automatically when an archived DVD containing SymPlayer is inserted into a PC DVD player. The following features are available:

- Frame advance forward and reverse button
- Replay button
- Fast reverse playback button
- Reverse playback button
- pause button
- Play button
- Fast play forward button
- Volume slider

Figure 110. The Symplayer



Chapter 7 Technical Specifications

This chapter provides the Technical Specifications of the SymDec 16 plus 4.

In this chapter:

- Technical Specifications* 136
 - General*..... 136
 - Connections* 136
 - Video*..... 136
 - Audio* 137
 - On-screen Video Indicators* 137
 - Part Numbers* 137
- Factory Defaults* 138
 - Menu defaults* 138
 - IP addresses* 138
 - Streaming defaults* 139

Technical Specifications

General

Power Supply	100-240 Volt AC, Auto-Ranging adapter
AC Amps	5A
Operating Temperature Range	Operating: 0 to 40 °C. Storage: -20 to +60 °C.
Relative Humidity Range (Non-Condensing)	Operating: 10% to 80%. Storage: 10% to 95%
Dimensions	Inches: 3.5 x 17.42 x 19.92, mm: 89 x 443 x 509
Weight	35.3 lbs. (16 kg)

Connections

Accessory I/O Port	DB-9 Male. Accessories Port
RS-232 Serial Port	RJ-45 Connector, 57600 Baud, 8,N,1, No flow control
Composite Video In	BNC Connector
Composite Video Out	BNC Connector
Audio In	RCA Connector
Audio Out	RCA Connector
10/100 Ethernet Port	RJ-45 Connector

Video

Video Signal Input	0.7 to 1.4 Volts peak-to-peak, with Automatic Gain Control
Video Signal Output	1 Volt peak-to-peak into 75-ohm
Input Termination	75-ohm
Colors	Y:U:V 4:2:2, 16.8 Million Colors
Gray Scale	256 Levels
Horizontal Resolution	720 Pixels
Vertical Resolution	484 Lines
Video Compression Standard	MPEG4
Audio Compression Standard	MPEG1 Layer 2

Audio

Audio Input:	315mV, 40k Ohms. Unbalanced.
Audio Output:	315mV, 600 Ohms. Unbalanced.

On-screen Video Indicators

Fast Forward Last Alarm Record Speed Playback Speed	Pause Play Record Capacity Reverse Play	Rewind Time and Date Video Loss
--	--	---------------------------------------

Part Numbers

User Manual	0150-0325
Rack Mount Kit	SYMDEC16+4-RK

All specifications are subject to change without notice. GE Security believes all specifications are correct, but no liability is assumed for omissions or errors.

Factory Defaults

Menu defaults

Function	Setting
Time Format	24 Hour
Date Format	MM / DD / YY
Normal Record Speed	30 frames per seconds (NTSC), 25 frames per second (PAL)
Alarm Record Speed	30 frames per seconds (NTSC), 25 pictures per second (PAL)
Record Quality	High
Disk Overwrite Mode	Continuous Overwrite
Auto Delete Mode	Off
Front Panel Locked	Off
Brightness	50%
Contrast	50%
Saturation	50%
Display Current Time and Date	Off
Display Last Alarm	Off
Display Record or Playback Speed	Off
Display Playback Time and Date	Off
Baud Rate	57600
Alarm Buzzer	Disabled

IP addresses

Address Type	Address
IP Address	192.168.1.82
Subnet Mask	255.255.0.0
Gateway address	192.168.1.1

Streaming defaults

Function	Setting
Streaming Mode (Normal Setup)	Disabled
Streaming Protocol (Normal Setup)	UDP
Streaming Port (Normal Setup)	8090
Streaming address (Normal Setup)	N/A
Receiver Cam Map ID Address for camera 4 (Normal Setup)	N/A
Sender Control Enable (Advanced Setup)	Selected
Sender Control Port (Advanced Setup)	8092
Receiver Control Enable (Advanced Setup)	Selected
Receiver Control Port (Advanced Setup)	8092

Chapter 8 Maintenance, support

This chapter provides information to help you contact technical support in case you need assistance with your GE equipment.

In this chapter:

- Contacting technical support* 142
- Online publication library* 142

Contacting technical support

For assistance installing, operating, maintaining, and troubleshooting this product, refer to this document and any other documentation provided. If you still have questions, you may contact technical support during normal business hours (Monday through Friday, excluding holidays, between 6 a.m. and 5 p.m. Pacific Time).

Table 42. Sales and support contact information

	Sales	Technical support
Phone:	Toll-free: 888.437.3287 (US, including Alaska and Hawaii; Puerto Rico; Canada) Outside the toll-free area: 503.885.5700	
E-mail	info@gesecurity.com	generaltech@ge.com
Fax	800.483.2495	541.752.9096 (available 24 hours a day)

Note: Be ready at the equipment before calling for technical support.

Online publication library

Another great resource for assistance with your GE product is our online publication library, available to all of our customers. To access the library, go to our website at the following location:

<http://www.gesecurity.com>

In the **Tools** area at the top, click the *Publication Library* link. After you register and log on, you may search through our online library for the documentation you need.¹

1. Many GE documents are provided as PDFs (portable document format). To read these documents, you will need Adobe Acrobat Reader, which can be downloaded free from Adobe's website at www.adobe.com.