

VR4930WDM VT4930WDM
VR4930WDM-R3 VT4930WDM-R3
VR4930WDM-6065 VT4930WDM-606
VR4930WDM-6065-R3 VT4930WDM-6065-R3

IFS Fiber Module Installation & Operation Instructions

VT/VR4930WDM

RS - 232 DATA

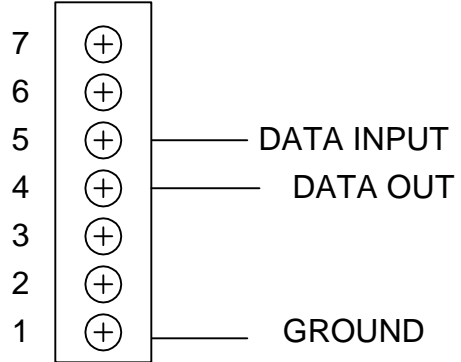

RS - 422 / 4-WIRE
RS-485 DATA

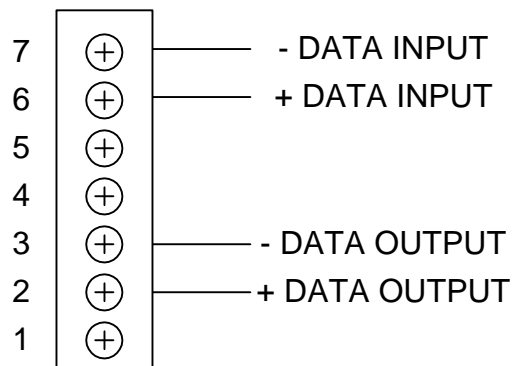

2-WIRE RS-485 DATA

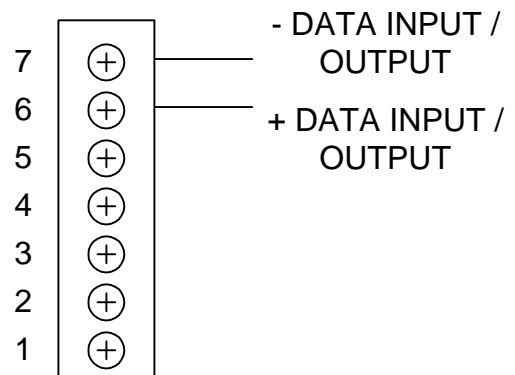

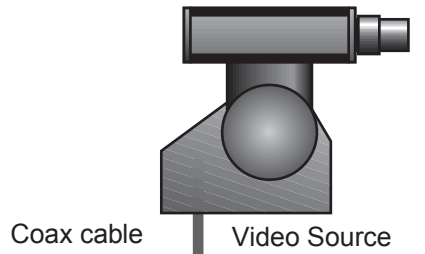
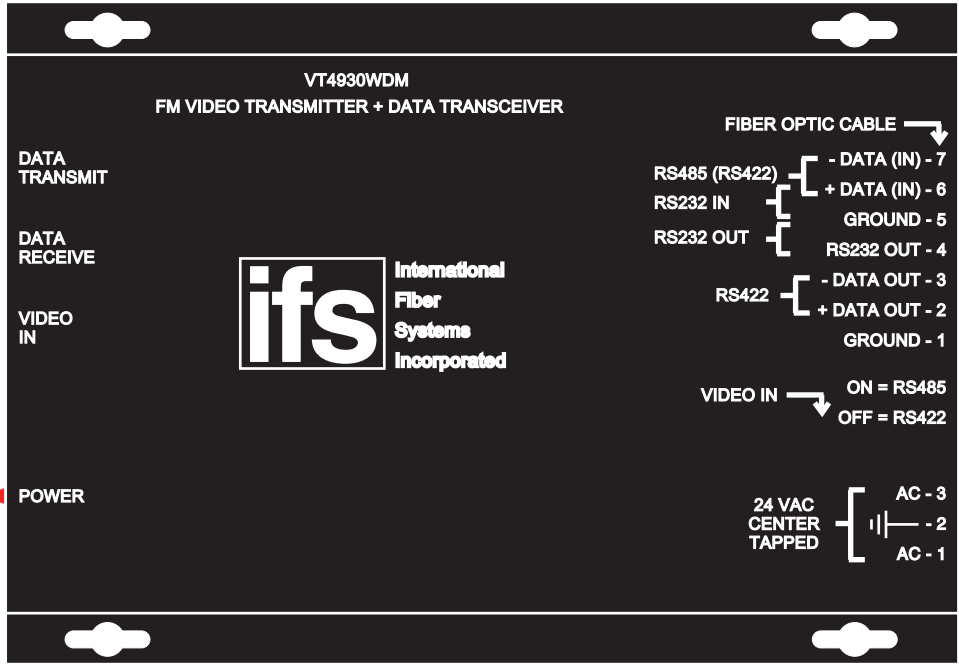

Simplex single mode fiber optic cable

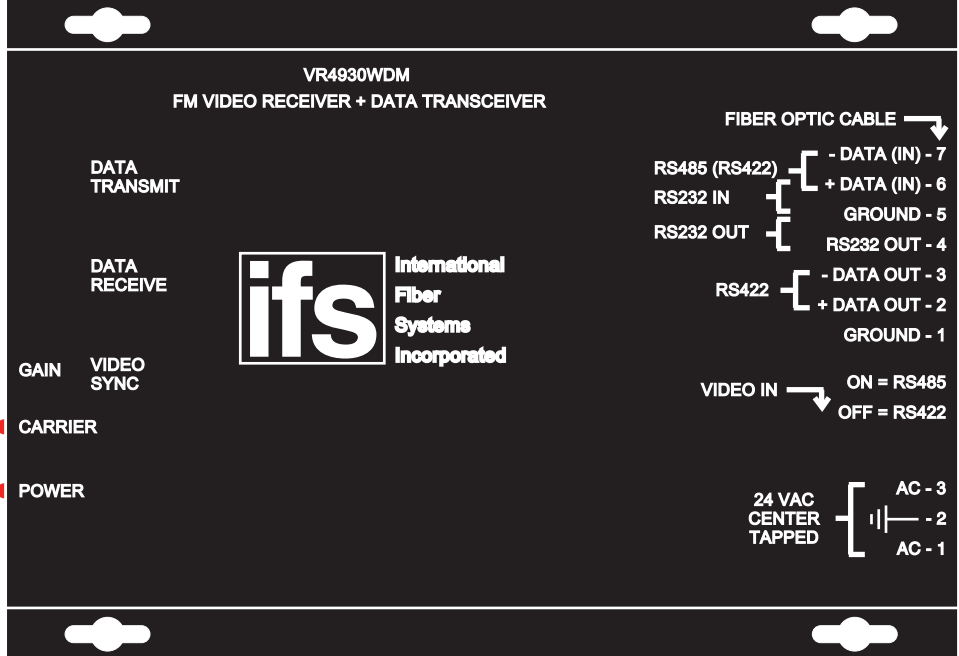

Coax cable



- ① - Data (In) } 2-wire RS485 or RS422 Data In (Switch selectable)
- ② + Data (In) } RS232 Data In
- ③ Ground } RS232 Data Out
- ④ - Data Out } RS422 Data Out
- ⑤ +Data Out }
- ⑥ Ground }

VT4930WDM

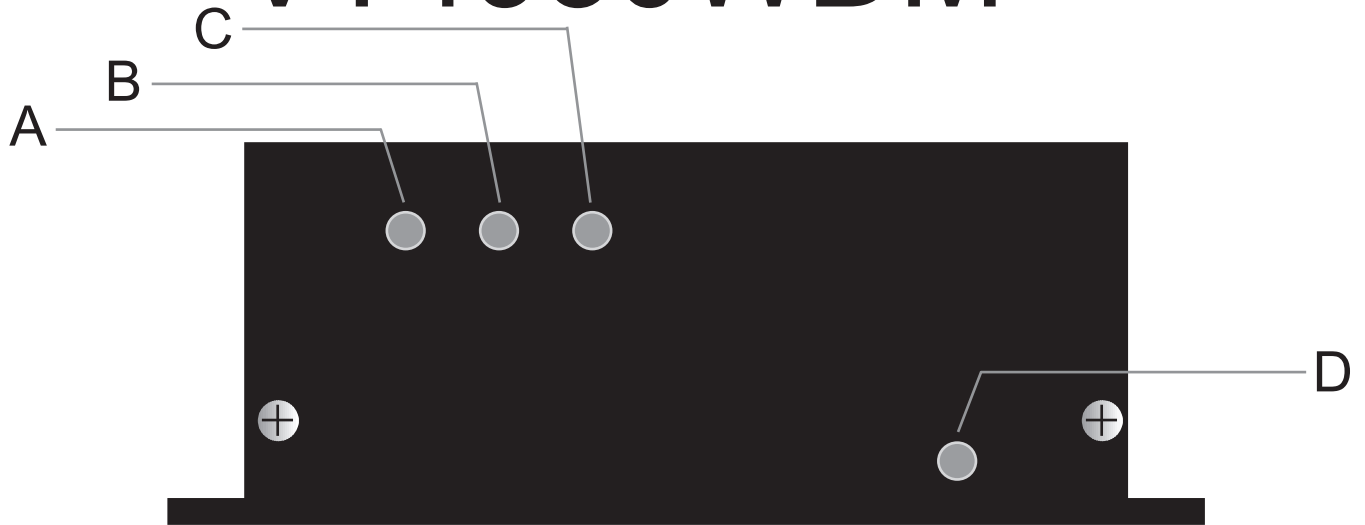

A	Data Transmit	LED illuminates
B	Data Receive	
C	Video In	
D	Power	

NOTE: WITHOUT PROPER FIBER CONNECTION, LED's DO NOT INDICATE CORRECT OPERATIONAL STATUS OF THE UNIT.

VR4930WDM

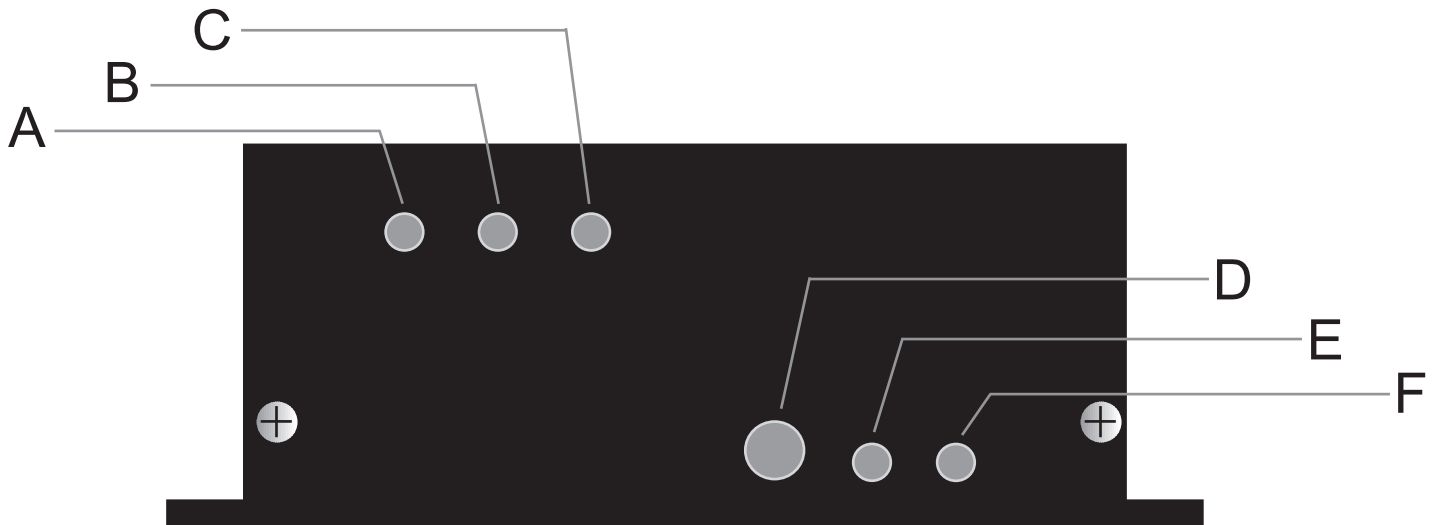

A	Data Transmit	LED illuminates
B	Data Receive	
C	Video Sync	
D	Gain Adjustment	
E	Carrier	LED illuminates
F	Power	

FCC Compliance

This device complies with Part 15 of the FCC Rules. Operation is subject to the following two conditions: (1) This device may not cause harmful interference, and (2) this device must accept any interference received, including interference that may cause undesirable operation.

Changes or modifications not expressly approved by International Fiber Systems, Inc. could void the user's authority to operate the equipment.

NOTE: This equipment has been tested and found to comply with the limits for a Class A digital device, pursuant to Part 15 of the FCC Rules. These limits are designed to provide reasonable protection against harmful interference when the equipment is operated in a commercial environment. This equipment generates, uses and can radiate radio frequency energy and, if not installed and used in accordance with the instruction manual, may cause harmful interference to radio communications. Operation of this equipment in a residential area is likely to cause harmful interference in which case the user will be required to correct the interference at his own expense.

CLASS 1 LASER PRODUCT
(For purposes of IEC 60825-1)

Complies with FDA Performance Standard for Laser Products
Title 21
Code of Federal Regulations
Subchapter J



Comprehensive Lifetime Warranty

- (a) Seller warrants to the original End User that products and any services furnished hereunder will be free from defects in material and workmanship as of the date of delivery, and will conform to Seller's published technical specifications. The foregoing shall apply only to failures to meet said warranties which appear within that period of time during which the Products are installed in their original installation for the original End User and operator of such Products; provided, however, that in the event of product discontinuance, warranty support is limited to five (5) years from the announcement of discontinuance. Notwithstanding the preceding sentence, the duration of the warranty period for products not manufactured by Seller (e.g., fiber optic cabling, test equipment, power supplies or batteries) shall be the warranty period offered by the original manufacturer, if any.
- (b) The conditions of any tests shall be mutually agreed upon and Seller shall be notified of, and may be represented at, all tests that may be made. The warranties and remedies set forth herein are conditioned upon (a) proper storage, installation, use and maintenance, and conformance with any applicable recommendations of Seller and (b) Buyer promptly notifying Seller of any defects and, if required, promptly making the product available for correction.
- (c) If any product or service fails to meet the foregoing warranties, Seller shall thereupon correct any such failure either at its option,
- (i) by repairing any defective or damaged product or parts of the products, or (ii) by making available any necessary repaired or replacement products or parts thereof. Any repaired or replacement part or product shall be warranted for the remaining period of the original Warranty Period. Seller shall pay, or credit Buyer for, the cost of freight for all return shipments of products or parts to Buyer. Where a failure cannot be corrected by Seller's reasonable efforts, the parties will negotiate an equitable adjustment in price.
- (d) The preceding paragraph sets forth the exclusive remedies for claims based on defect in or failure of products or services, whether the claim is in contract, indemnity, warranty, tort (including Seller's negligence), strict liability or otherwise and however instituted. Upon the expiration of the warranty period, all such liability shall terminate and BUYER shall have a reasonable time, within thirty days after the warranty period, to give written notice of any defects which appeared during the warranty period. The foregoing warranties are exclusive and in lieu of all other warranties, whether written, oral, implied or statutory. NO IMPLIED OR STATUTORY WARRANTY OF MERCHANTABILITY OR FITNESS FOR PARTICULAR PURPOSE SHALL APPLY. Seller does not warrant any products or services of others which BUYER has designated.

Contacting us

For help installing, operating, maintaining, and troubleshooting this product, refer to this document and any other documentation provided. If you still have questions, contact us during business hours (Monday through Friday, excluding holidays, between 5 a.m. and 5 p.m. Pacific Time).

Sales and support contact information

North America	Toll-free: 855.286.8889 in the US, including Alaska and Hawaii; Puerto Rico; Canada. Outside the toll-free area: 503.885.5700. E-mail: techsupport@interlogix.com
Europe	Select <i>Contact Us</i> at www.utcssecurityproducts.eu
Australia	security.tech.support@interlogix.com.au

Note: Be ready at the equipment before calling.

Online

Another great resource for assistance with your Interlogix product is our online publication library. To access the library, go to our website at the following location:

<http://www.interlogix.com/transmission>¹

1. Many Interlogix documents are provided as PDFs (portable document format). To read these documents, you will need Adobe Reader, which can be downloaded free from Adobe's website at www.adobe.com.

Product Disassembly Instructions for WEEE

Per European Directive 2002/95/EC Waste Electrical and Electronic Equipment

Required Tools:





- One number 2 Phillips (crosstip) screwdriver.**
- One number 2 flat screwdriver.**

For the enclosed box version:

- 1. Locate and remove box cover securement screws. Usually, but not limited to, at least 4 screws.**
- 2. Lift off box top cover.**
- 3. Locate and remove securement screws for printed circuit board.**
- 4. If there are multiple boards to the assembly, continue removing securement screws until none are left.**
- 5. Lift off printed circuit board.**
- 6. Disassembly of box version of product is complete.**

For rack version:

- 1. Locate and remove securement screws for printed circuit board. Usually, but not limited to, at least 4 screws.**
- 2. If there are multiple boards to the assembly, continue removing securement screws until none are left.**
- 3. Lift off printed circuit board(s).**
- 4. Disassembly of rack card version of product is complete.**

Copyright	© 2011 UTC Fire & Security. All rights reserved.
Trademarks and patents	Interlogix and IFS names and logos are trademarks of UTC Fire & Security. Other trade names used in this document may be trademarks or registered trademarks of the manufacturers or vendors of the respective products.
Manufacturer	UTC Fire & Security Americas Corporation, Inc. 2955 Red Hill Avenue, Costa Mesa, CA 92626-5923, USA Authorized EU manufacturing representative: UTC Fire & Security B.V. Kelvinstraat 7, 6003 DH Weert, The Netherlands
Certification	  N4131
ACMA compliance	Notice! This is a Class A product. In a domestic environment this product may cause radio interference in which case the user may be required to take adequate measures.
Canada	This Class A digital apparatus complies with Canadian ICES-003. Cet appareil numérique de la classe A est conforme à la norme NMB-003 du Canada.
European Union directives	2004/108/EC (EMC directive): Hereby, UTC Fire & Security declares that this device is in compliance with the essential requirements and other relevant provisions of Directive 2004/108/EC.
 	2002/96/EC (WEEE directive): Products marked with this symbol cannot be disposed of as unsorted municipal waste in the European Union. For proper recycling, return this product to your local supplier upon the purchase of equivalent new equipment, or dispose of it at designated collection points. For more information see: www.recyclethis.info .
Contact information	For contact information, see www.interlogix.com .