



TruVision Dome Brackets Installation Manual

Copyright © 2014 UTC Fire & Security Americas Corporation, Inc.

Interlogix is part of UTC Climate Controls & Security, a unit of United Technologies Corporation. All rights reserved.

Trademarks and patents The TruVision name and logo are trademarks of United Technologies.

Other trade names used in this document may be trademarks or registered trademarks of the manufacturers or vendors of the respective products.

Certification



2002/96/EC (WEEE directive): Products marked with this symbol cannot be disposed of as unsorted municipal waste in the European Union. For proper recycling, return this product to your local supplier upon the purchase of equivalent new equipment, or dispose of it at designated collection points. For more information see: www.recyclethis.info.



Contact information

For contact information, see www.utcfireandsecurity.com or www.utcssecurityproducts.eu.

Content

Introduction 2

Bracket and cup base descriptions 2

Wall-mount installation (TVD-SNB and TVD-M2-WM) 4

5-inch dome cameras 4

3-inch dome cameras 6

2-inch dome wedge cameras 7

Flush-mount installation (TVD-M2-FM) 8

5-inch dome indoor cameras 8

Pendant-mount installation (TVD-PPB) 10

5-inch dome cameras 10

3-inch dome cameras 11

2-inch dome wedge cameras 12

Pole-mount installation (TVD-M-PMA) 13

Specifications 14

Pipe threading information 15

Overview: Fixed dome cameras by bracket 16

Introduction

These are the installation instructions for the TruVision series of dome brackets and cup bases. The series brackets and cup bases are compatible with both indoor and outdoor Interlogix cameras

Models

For a list of the brackets and cup bases with their corresponding cameras, see “Overview: Fixed dome cameras by bracket” on page on page 16.

Packet contents

The package contains the following items:

- Bracket or cup base
- Accessories for installation
- Screws

Unpacking

Please check the package contents to ensure that all parts are present and in good condition.

Note: For safety purposes, the mounting surface must be able to support three times the combined weight of the bracket, cup base, and camera.

Bracket and cup base descriptions

TruVision dome swan-neck bracket (TVD-SNB)

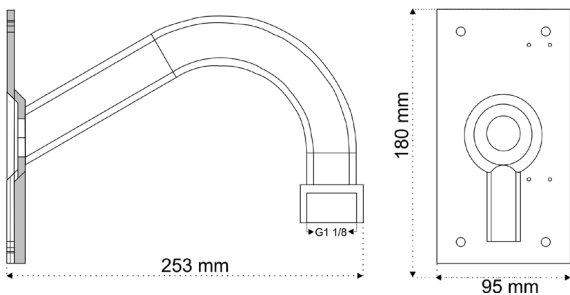

TruVision dome pendant-mount ceiling bracket (TVD-PPB)

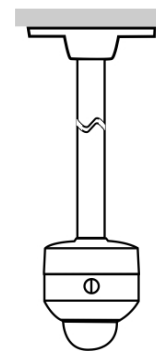
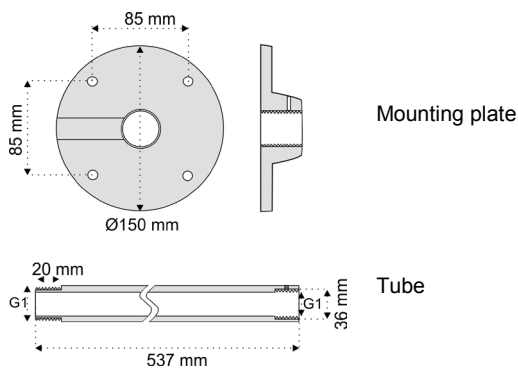

TruVision flush-mount bracket (TVD-M2-FM)

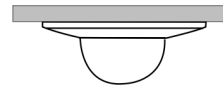
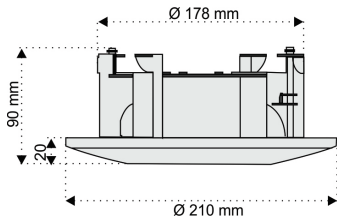

TruVision pole-mount adaptor (TVD-M-PMA)

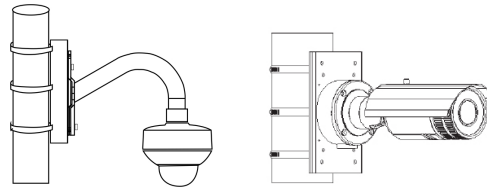
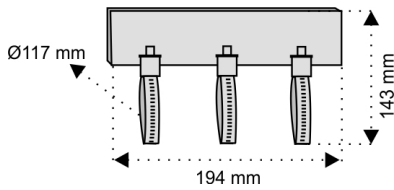

TruVision indoor dome wall-mount bracket (TVD-M2-WM)

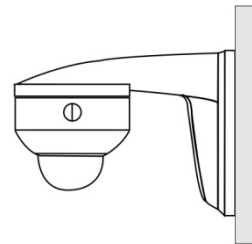
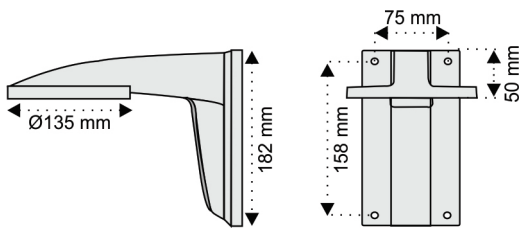

TruVision dome cup bases

- TVD-CB5:

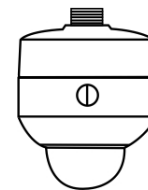
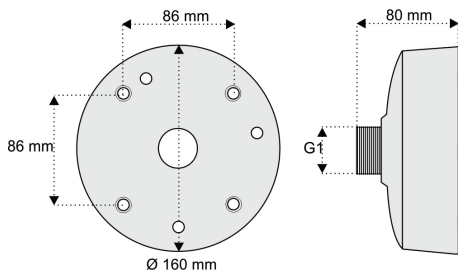

Note: The rubber ring for TVD-CB5 is pre-installed in the cup base.

- TVD-CB5A:

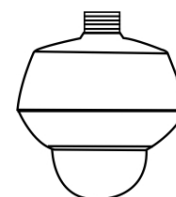
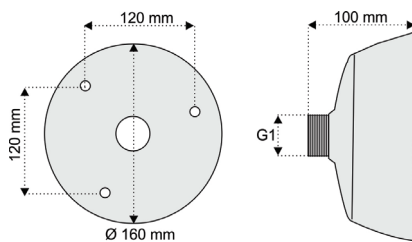

Note: The rubber ring for TVD-CB5A is pre-installed in the cup base.

- TVD-CB3:

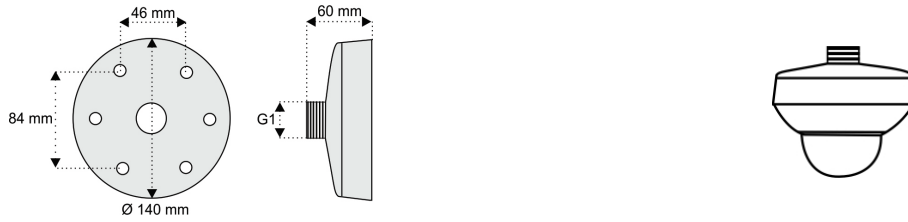

- TVD-CB2:

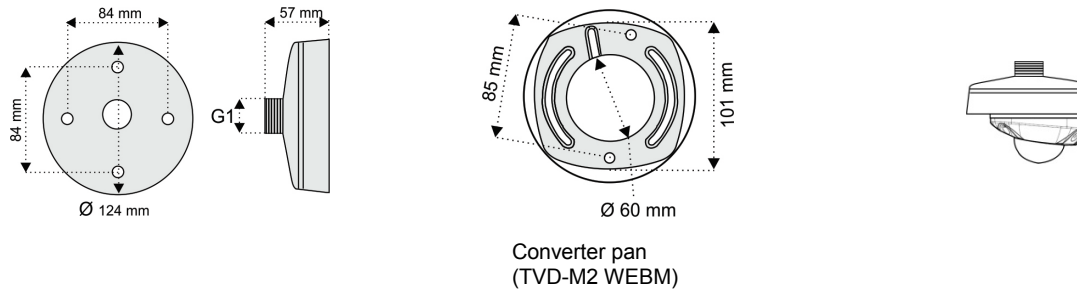

Accessories

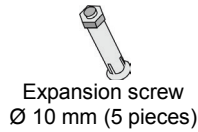
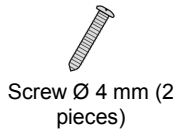

Wall-mount installation (TVD-SNB and TVD-M2-WM)

Check the section “Overview: Fixed dome cameras by bracket” on page 16 to confirm that the correct bracket is used with the camera.

5-inch dome cameras

Use the TVD-SNB bracket and the TVD-CB5/TVD-CB5A cup base. See “Bracket and cup base description” on page 2 for examples of the assembled brackets.

To mount a swan-neck bracket on a wall:

1. Pull the camera cables through the bracket tube and then attach the swan-neck bracket to the wall with the expansion screws (A) provided.

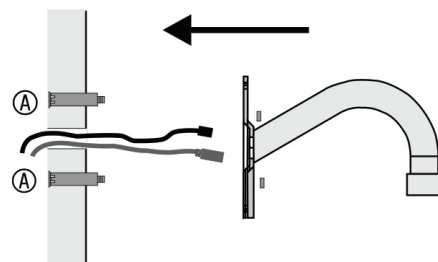

2. Screw the cup base onto the swan-neck bracket and fasten with the locking screw, as shown.

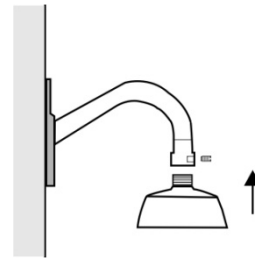

3. TVD-CB5 only:

Using the enclosed screws, attach the cup base to the camera housing.

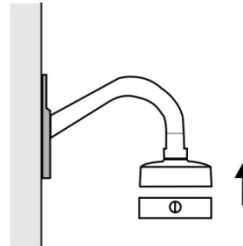

4. Loosen the screws on the dome enclosure (1) using the supplied hex wrench, and remove the enclosure and dome liner (2).

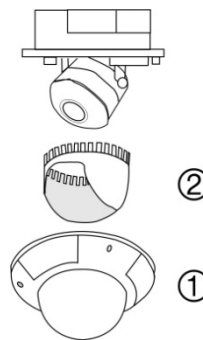

5. Connect the cables to the dome camera.
6. Insert the dome module into the cup base (TVD-CB5A shown) and attach using the enclosed screws.

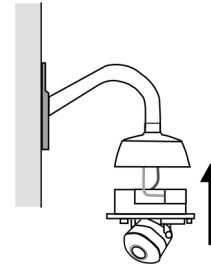

7. Re-attach the dome liner and enclosure to the camera.

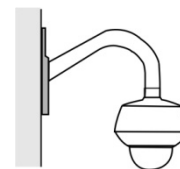

3-inch dome cameras

Use the TVD-SNB bracket with the TVD-CB3 cup base or TVD-M2-WM bracket. See “Bracket and cup base description” on page 2 for examples of the assembled brackets.

To mount a swan-neck bracket on a wall:

1. Pull the camera cables through the TVD-SNB bracket tube and then attach the swan-neck bracket to the wall with the expansion screws (A) provided.

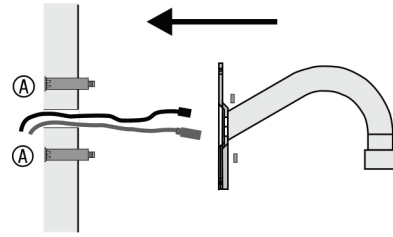

2. Screw the cup base onto the swan-neck bracket and fasten with the locking screw, as shown (A).

Then attach the mounting plate (B) to the cup base.

Note: The mounting plate is shipped with the dome camera.

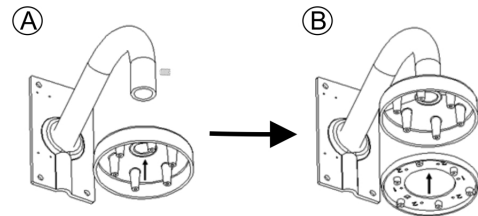

3. Loosen the screws on the dome enclosure using hex wrench, and remove the dome enclosure and the liner.

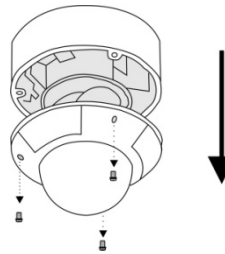

4. Connect the cables to the dome camera.
5. Using the enclosed screws, attach the dome module of the camera (A) to the bracket.

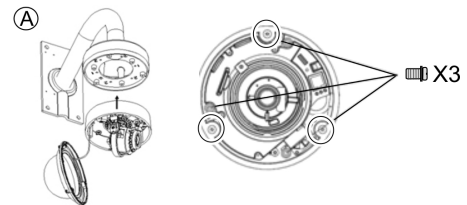

Then re-attach the dome liner and enclosure (B).

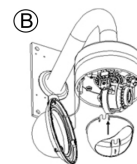

6. Re-attach the dome enclosure to the camera.

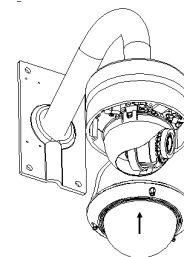

To mount an indoor wall-mount bracket:

1. Pull the camera cables through the TVD-M2-WM bracket tube and then attach the bracket to the wall with the expansion screws (A) provided.

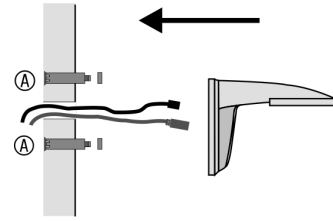

2. Attach the mounting plate to the bracket.

Note: The mounting plate is shipped with the dome camera.

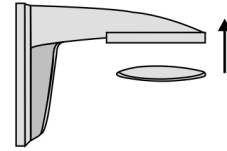

3. Loosen the screws on the dome enclosure using the supplied hex wrench and remove the dome enclosure and liner from the dome module.
4. Connect the cables to the dome camera.

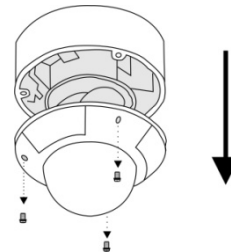

5. Using the enclosed screws, attach the dome module of the camera to the bracket.

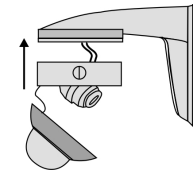

6. Re-attach the dome liner and enclosure to the camera.

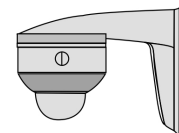

2-inch dome wedge cameras

Use the TVD-SNB bracket and the TVD-CB2 cup base. See “Bracket and cup base description” on page 2 for examples of the assembled brackets.

To mount a swan-neck bracket on a wall:

1. Pull the camera cables through the bracket tube and then attach the swan-neck bracket to the wall with the expansion screws (A) provided.

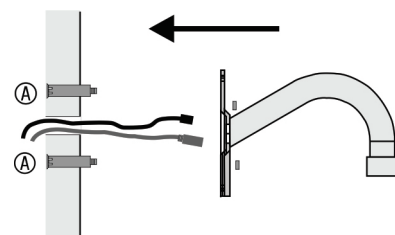

2. Using four screws, attach the converter pan (TVD-M2 WEBM) to the cup base.



3. Then screw the cup base onto the swan-neck bracket and fasten with the locking screw.

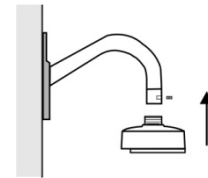

4. Loosen the screws on the dome enclosure using the supplied hex wrench and remove it.

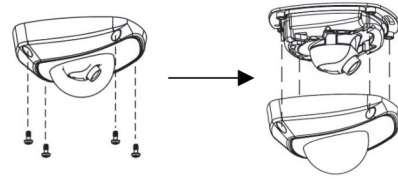

5. Connect the cables to the dome camera.
Using two screws, attach the camera base plate to the converter pan on the cup base.

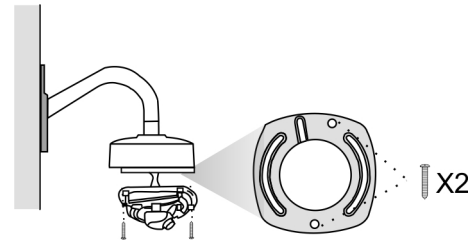

6. Re-attach the camera enclosure to the camera.

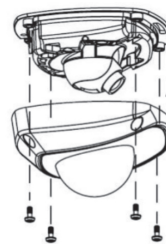

Flush-mount installation (TVD-M2-FM)

Check the section “Overview: Fixed dome cameras by bracket” on page on page 16 to confirm that the correct bracket is used with the camera.

Note: For safety purposes, the mounting surface must be able to support three times the combined weight of the bracket, cup base, and camera.

5-inch dome indoor cameras

Use the TVD-M2-FM bracket. See “Bracket and cup base description” on page 2 for examples of the assembled brackets.

To mount a flush-mount bracket on a ceiling:

1. On the false ceiling, mark the position and size of the housing pass-through hole. Cut a hole with a diameter of between 176 and 180 mm. Make sure the cables for the camera are prepared.

Note: The ceiling thickness must be less than 30 mm.

- Using screws provided, fasten the mounting plate (A) to the in-ceiling mounting base (B).

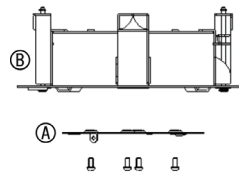

- Push the dome camera into the in-ceiling mounting base.

Caution: For safety reasons, use safety cables to securely attach the camera dome to the in-ceiling mounting base and to attach the in-ceiling mounting base to the building's infrastructure.

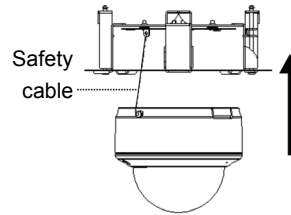

- Rotate the camera 10 degrees counterclockwise (A) and then securely fasten the camera to the in-ceiling mounting base using the lock screws (B).

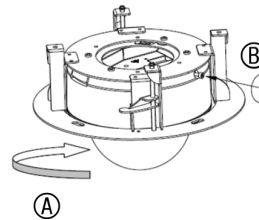

- Push the camera with in-ceiling mounting base into the ceiling hole.

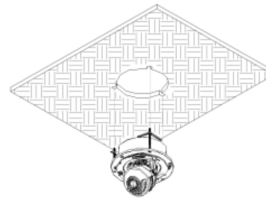

- Using the lock screws (A), securely fasten the camera to the ceiling.

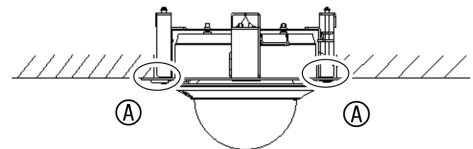

- To set up the camera image, remove the camera enclosure and connect the RCA analog video output to a monitor (D).

Loosen the lens set screw (E) and pan (A), tilt (B) or rotate (C) the lens to obtain the desired surveillance angle. Adjust the lens focus. When all adjustments have been done, refasten the lens set screw.

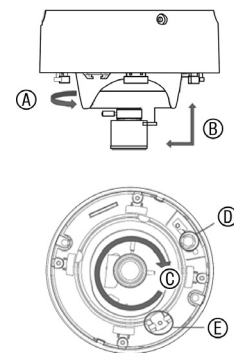

- Using screws, attach the trim ring to the in-ceiling mounting base on the ceiling.

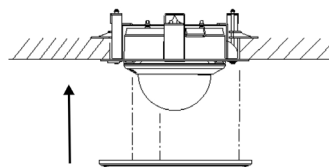

Pendant-mount installation (TVD-PPB)

Check the section “Overview: Fixed dome cameras by bracket” on page 16 to confirm that the correct bracket is used with the camera.

5-inch dome cameras

Use the TVD-PPB bracket and the TVD-CB5/TVD-CB5A cup base. See “Bracket and cup base description” on page 2 for examples of the assembled brackets.

To mount a pendant-mount bracket on a ceiling:

1. Screw the mounting plate onto the tube and fasten with the locking screw.
2. Pull the camera cables through the bracket tube and then attach the bracket to the ceiling with expansion screws.
3. Screw the cup base onto the tube and fasten with the locking screw.
4. TVD-CB5 only:
Using the enclosed screws, attach the camera housing to the cup base.
5. Loosen the screws on the dome enclosure (1) using the supplied hex wrench, and remove the dome enclosure and liner (2).

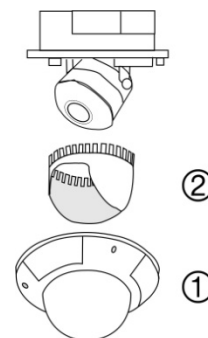
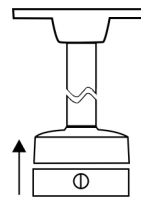
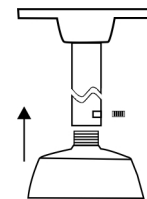
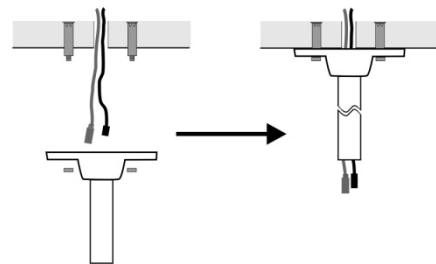
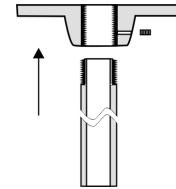

6. Connect the cables to the dome camera.
7. Insert the dome module into the cup base.
8. Re-attach the dome liner and enclosure to the camera.

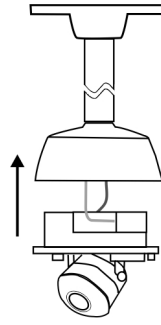

3-inch dome cameras

Use the TVD-PPB bracket and the TVD-CB3 cup base. See “Bracket and cup base description” on page 2 for examples of the assembled bracket.

To mount a pendant-mount bracket on a ceiling:

1. Screw the mounting plate onto the tube and fasten with the locking screw, as shown.
2. Pull the camera cables through the bracket tube and then attach the bracket to the ceiling with expansion screws.

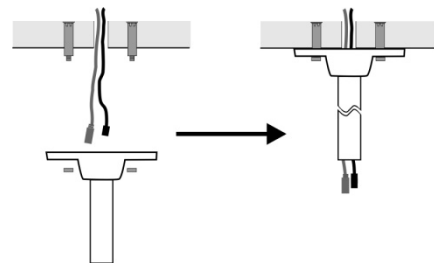
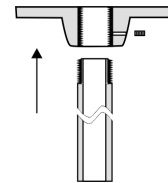

3. Screw the cup base onto the tube and fasten with the locking screw (A).

Using the enclosed screws, attach the camera mounting plate (B) to the cup base.

Note: The camera mounting plate is shipped with the dome camera.

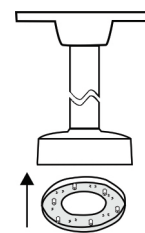

4. Loosen the screws on the dome enclosure (1) using the supplied hex wrench, and remove the dome enclosure and liner (2).

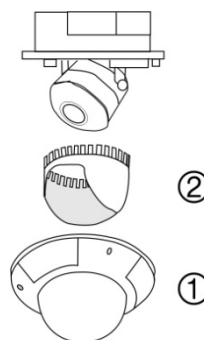

5. Connect the cables to the dome camera.
6. Using screws, attach the dome module to the mounting plate.

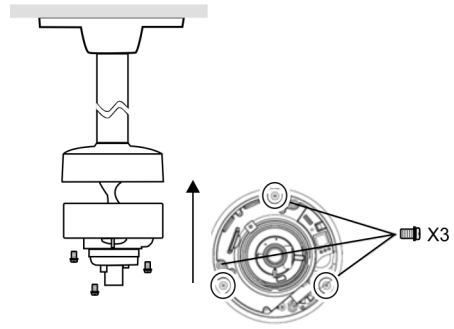

7. Re-attach the dome liner and enclosure to the camera.

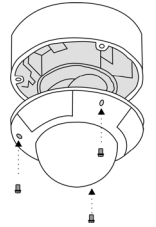

2-inch dome wedge cameras

Use the TVD-PPB bracket and the TVD-CB2 cup base.

To mount a pendant-mount bracket on a ceiling:

1. Screw the mounting plate onto the tube and fasten with the locking screw, as shown.
2. Pull the camera cables through the bracket tube and then attach the bracket to the ceiling with expansion screws.
3. Using four screws, attach the converter pan TVD-M2 WEBM to the cup base.
Then screw the cup base onto the pendant-mount bracket and fasten with the locking screw.
4. Loosen the screws on the dome enclosure using the supplied hex wrench and remove it.

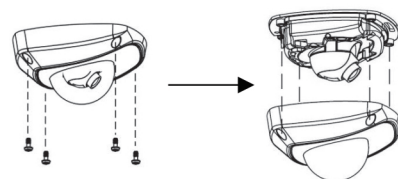
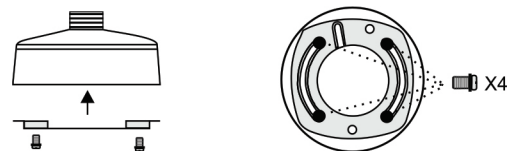
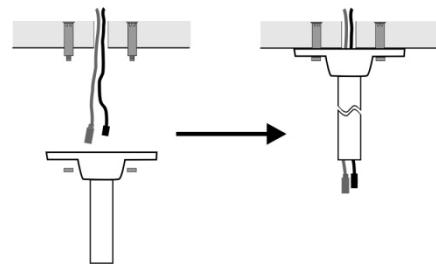
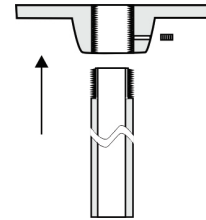

- Using 2 screws, attach the camera base plate to the converter pan.

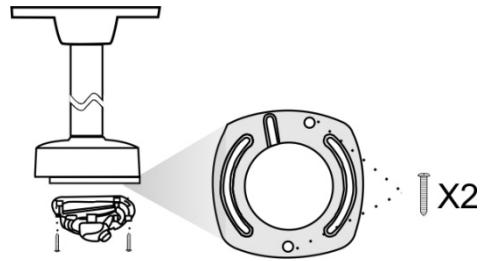

- Re-attach the camera enclosure to the camera.

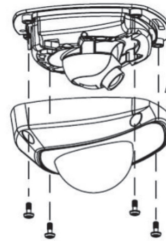

Pole-mount installation (TVD-M-PMA)

Check the section “Overview: Fixed dome cameras by bracket” on page16 to confirm that the correct bracket is used with the camera.

Use the TVD-M-PMA pole-mount adaptor to mount a camera on a pole.

To mount a swan-neck bracket on a pole:

- At the desired mounting place, securely fasten the TVD-M-PMA pole-mount adaptor to the pole. Pull the cables through the mount.
- Pull the camera cables through the TVD-SNB bracket tube and then attach the bracket to the pole mount with the screws provided.

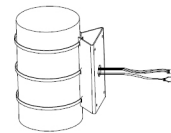

- Screw the cup base onto the swan-neck bracket and fasten with the locking screw, as shown (A).

Then attach the mounting plate (B) to the cup base.

Note: The mounting plate is shipped with the dome camera.

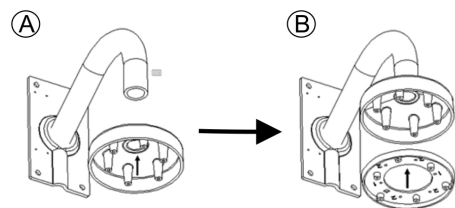
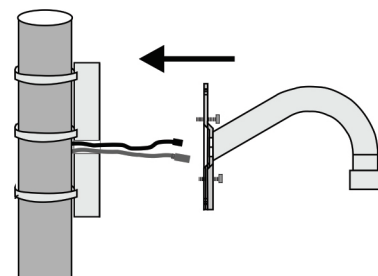

- Loosen the screws on the dome enclosure using the supplied hex wrench, and remove the dome enclosure and liner.

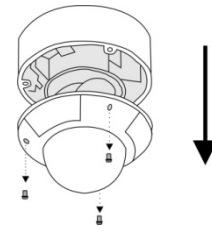

- Connect the cables to the dome camera.
- Using the enclosed screws, attach the dome module of the camera to the bracket.

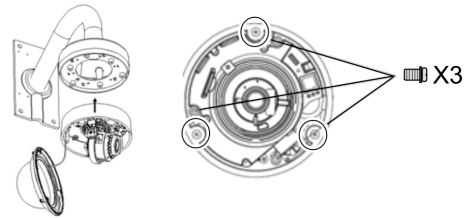

- Re-attach the dome liner and enclosure to the camera.

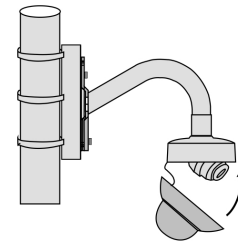

To mount a bullet camera on a pole:

- At the desired mounting place, securely fasten the TVD-M-PMA pole-mount adaptor to the pole. Pull the cables through the mount.
- Connect the cables to the camera.
- Use the enclosed screws to attach the camera to the pole mount.
- Adjust the camera position and angle as required.

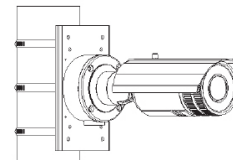
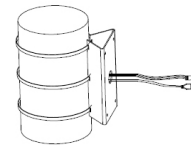

Specifications

SKU	Dimensions	Weight
TVD-SNB	253 × 95 × 180 mm	490 g (1.2 lb)
TVD-PPB	Ø 150 × 537 mm	1169 g (2.56 lb)
TVD-M2-FM	Ø 210 × 90 mm	540 g (1.19 lb)
TVD-M-PMA	117 × 194 × 143 mm	1205 g (2.66 lb)
TVD-M2-WEBM	Ø135 × 9 mm	25 g (0.05 lb)
TVD-M2-WM	Ø135 × 182.5 × 251 mm	580 g (1.28 lb)
TVD-CB5	Ø 160 × 80 mm	490 g (1.2 lb)
TVD-CB5A	Ø 160 × 100 mm	340 g (0.75 lb)
TVD-CB3	Ø 140 × 60 mm	320 g (0.71 lb)
TVD-CB2	Ø 124 × 57 mm	190 g (0.42 lb)

Pipe threading information

Pipe thread size	Threads / in	Pitch (mm)	Thread major diameter		Corresponding pipe				Tapping drill size (mm)
			(mm)	(in.)	DN	OD (mm)	OD (in.)	Thickness (mm)	BSP. F (G)
G 1	11	2.309	33.249	1.309	25	33.7	1.33	3.2	30.75

Overview: Fixed dome cameras by bracket

Bracket to use

Class	Camera SKU	Flush-mount	Wall-mount						Pendant/ceiling-mount				Pole-mount				Suitable for outdoor / indoor use
		TVD-M2-FM	TVD-SNB				TVD-M2-WM	TVD-M2-WEBM	TVD-PPB				TVD-M-PMA				
			TVD-CB2 & TVD-M2-WEBM	TVD-CB3	TVD-CB5	TVD-CB5A			TVD-CB2 & TVD-M2-WEBM	TVD-CB3	TVD-CB5	TVD-CB5A	TVD-CB2 & TVD-M2-WEBM	TVD-CB3	TVD-CB5	TVD-CB5A	
Analog	TVD-2101																Outdoor
Analog	TVD-4102																Outdoor
Analog	TVW-2101		■					■	■				■				Outdoor
Analog	TVW-4101		■					■	■				■				Outdoor
Analog	TVD-5110-3-N(P)																Indoor
Analog	TVD-5125TE-3-N(P)																Outdoor
Analog	TVD-6120VE-2-N(P)			■					■				■				Outdoor
Analog	TVD-6125VE-2-N(P)			■					■				■				Outdoor
Analog	TVD-DOME5-HR9-N(P)																Indoor
Analog	TVD-DOME6-HR-N(P)																Indoor
Analog	TVD-TIR6-HR-N(P)																Outdoor
Analog	TVD-TIR6-MR-N(P)																Outdoor
Analog	TVD-TIR6-SR-N(P)																Outdoor
Analog	UVD-6120VE-2-N(P)																Outdoor
Analog	UVD-6130VE-2-N(P)																Outdoor
Analog	UVD-XP4DNR-VA2-N(P)																Outdoor
Analog	UVD-XP4DNR-VA9-N(P)																Outdoor
IP	TVD-1103			■					■				■				Outdoor
IP	TVD-3103			■					■				■				Outdoor
IP	TVD-1104			■					■				■				Outdoor

Class	Camera SKU	Flush-mount	Wall-mount						Pendant/ceiling-mount				Pole-mount				Suitable for outdoor / indoor use
		TVD-M2-FM	TVD-SNB				TVD-M2-WM	TVD-M2-WEBM	TVD-PPB				TVD-M-PMA				
			TVD-CB2 & TVD-M2-WEBM	TVD-CB3	TVD-CB5	TVD-CB5A			TVD-CB2 & TVD-M2-WEBM	TVD-CB3	TVD-CB5	TVD-CB5A	TVD-CB2 & TVD-M2-WEBM	TVD-CB3	TVD-CB5	TVD-CB5A	
IP	TVD-3104																Outdoor
IP	TVW-1101																Outdoor
IP	TVW-1102																Outdoor
IP	TVD-M1210W-2-N(P)																Outdoor
IP	TVD-M1210W-2B-N(P)																
IP	TVD-M1210W-2W-N(P)																
IP	TVD-M1210V-2-N(P)																Indoor
IP	TVD-M1225V-2-N(P)																Indoor
IP	TVD-M1245E-2M-N(P)																Outdoor Flush-mount included
IP	TVD-M2210V-2-N(P)																Indoor
IP	TVD-M2210W-4-N(P)																Outdoor
IP	TVD-M2225V-2-N(P)																Indoor
IP	TVD-M3210V-2-N(P)																Indoor
IP	TVD-M3225V-2-N(P)																Indoor
IP	TVD-M3245E-2M-N(P)																Outdoor
IP	TVD-M5225E-3M-N(P)																Outdoor
IP	TVD-M5225V-4-N(P)																Indoor
IP	TVD-N210V-2-N(P)																Indoor
IP	TVD-N210W-4-N(P)																Outdoor
IP	TVD-N225E-2M-N(P)																Outdoor Flush-mount included
IP	TVD-N245V-2-N(P)																Indoor
IP	UVD-IP-XP4DNR-VA2-N(P)																Outdoor
IP	UVD-IP-XP4DNR-VA9-N(P)																Outdoor

