

MOOSE Z950

Security System Control

MOOSE 

A PRODUCT OF SENTROL, INC

Sentrol, Inc. reserves the right to change specifications without notice.

SENTROL CONTROLS GROUP
PO Box 2904
1510 Tate Blvd. SE
Hickory, NC 28603
Sales: 800.547.2556
Fax: 503.691.7566
Technical Support: 800.800.2027

©1995 Sentrol, Inc.

64812672A

Specifications, Installation
and Programming Guide

Introduction

The Z950 Security Control incorporates today's most desired operational features including upload/download, dual reporting, EEPROM memory, advanced lightning/transient protection and ease of user operation, all in an attractively priced package. The control is shipped with a factory basic program. Three definable panic zones are accessible from the keypads. Two high current and two low current outputs are programmable to provide +12 VDC upon any alarms, or to selected non-alarm conditions.

Non-volatile EEPROM (electrically erasable programmable read only memory), allows the control to be easily programmed from the keypad, eliminating the need to burn PROMS. The EEPROM maintains its data even with power disconnected. A watchdog circuit monitors the microprocessor and assures operational integrity of the system. The control may also be programmed remotely with the aid of a personal computer and Hayes modem using the TRANSPORT PC software package.

The keypads feature easy to read numbers, a green indicator for READY status and a red indicator for ARMED status. The control may also be armed/disarmed with a momentary or shunt type key switch. Arming/Disarming the system can be easily accomplished by entering a four digit code.

This product has been carefully inspected to comply with rigid quality control standards before shipment to you. You will find that with reasonable care, it will provide years of reliable performance. Proper installation and regular maintenance by the installing company and frequent testing by the user are essential to assure continuous satisfactory operation of any alarm system.

LIMITATIONS

The Z950 is designed as part of a system designated to warn against unauthorized entry or of other situations. However, it is not a guarantee of protection against the occurrence of those events. Any alarm system is subject to compromise or failure to warn for various reasons: Unauthorized access can be gained through unprotected points or by disarming or bypassing protected points. Sensing devices are power driven and will not operate without electrical power. Telephone lines over which alarm signals are transmitted may be out of service or rendered inoperable by an intruder. Smoke detectors have limitations and cannot detect all types of fires or sense smoke out of the effective range of the detector.

ALL RIGHTS RESERVED

No part of this publication may be reproduced, stored in a retrieval system, or transmitted in any form or by any means — electronic, mechanical, photocopying, recording, or otherwise without the prior written permission of the manufacturer. The material in this publication is for information purposes and subject to change without notice. The manufacturer assumes no responsibility for any errors which may appear in this publication. Printed in U.S.A.

ff **SPECIAL NOTE** referencing the word "Fire" in this manual.

Use of this control for fire detection and/or annunciation may not be permitted by certain states, counties, municipalities, or local jurisdiction. It is the responsibility of the installing alarm company to check with their local A.H.J. (Authority Having Jurisdiction) or State Fire Marshals' office prior to using this control for fire.

Table Of Contents

Chapter 1. Installation And Wiring

- 1.1 Planning The Installation 1-1
- 1.2 Parts Diagram & Descriptions 1-3
- 1.3 Mounting And Wiring Preparation 1-4
- 1.4 Wiring 1-4

Chapter 2. Operating The System

- 2.1 Powering Up The Control 2-1
- 2.2 The Keypad 2-3

Chapter 3. Programming The Control

- 3.1 Installer Level Programming 3-1
- 3.2 User Level Programming 3-7
- 3.3 Special Programmable Features 3-9
- 3.4 Program Function Descriptions 3-13

Program Function Map (Removable)

Chapter 4. Z950 Specifications

- 4.1 Technical Specifications 4-1
- 4.2 Features 4-2
- 4.3 Optional Accessories 4-4

Chapter 5. U.L. And N.F.P.A. Requirements

- 5.1 Underwriters Laboratories (U.L.) Listing 5-1
- 5.2 National Fire Protection Association (N.F.P.A.) Rules 5-1

Index

THIS PAGE INTENTIONALLY LEFT BLANK

Installation And Wiring **1**

1.1 Planning The Installation

The first step in any multi-zone security system installation is planning the job.

1. **Read through this entire manual** to familiarize yourself with all system features and procedures before actually beginning the installation. Section 5 contains information regarding Underwriters Laboratories (U.L.) and N.F.P.A. requirements.
2. Perform a physical survey of the installation site.
3. Discuss the installation requirements and applications with the customer.
4. Compare the installation requirements and applications with the factory default settings (see Z950 Function Map, pages A–L) to determine what customized programming will be needed to meet the specific installation requirements.
5. Bench test the system prior to installation.

NOTE

FIGURE 1–1 on page 1–2 details typical fire and burglar installation layouts. This can be used as a guide in planning the specific installation.

TYPICAL FIRE INSTALLATION LAYOUT

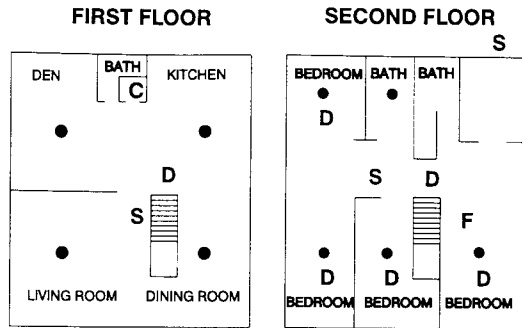

Note: Alternate locations may be required for the devices indicated.

TYPICAL BURGLAR INSTALLATION LAYOUT

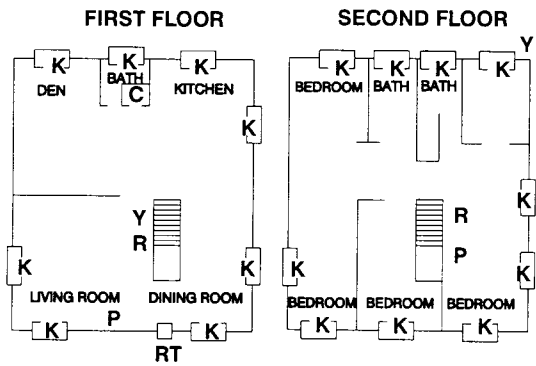

Note: All perimeter openings below 18' should be provided with protection.

LEGEND

C - Control	F - Fire Trouble Remote
S - Siren (Steady Output)	K - Contact
Y - Siren (Yelp Output)	R - Remote On/Off
D - Smoke Detector	P - Panic Button
• - Thermostat	RT - Remote On/Off With Tamper

FIGURE 1-1. Typical Installation Layout

NOTE: Refer to Section 5 for U.L. Listed System Requirements

1.2 Parts Diagram & Descriptions

FIGURE 1-2 details parts of the Z950 Control. These parts will be referenced in later sections of this manual.

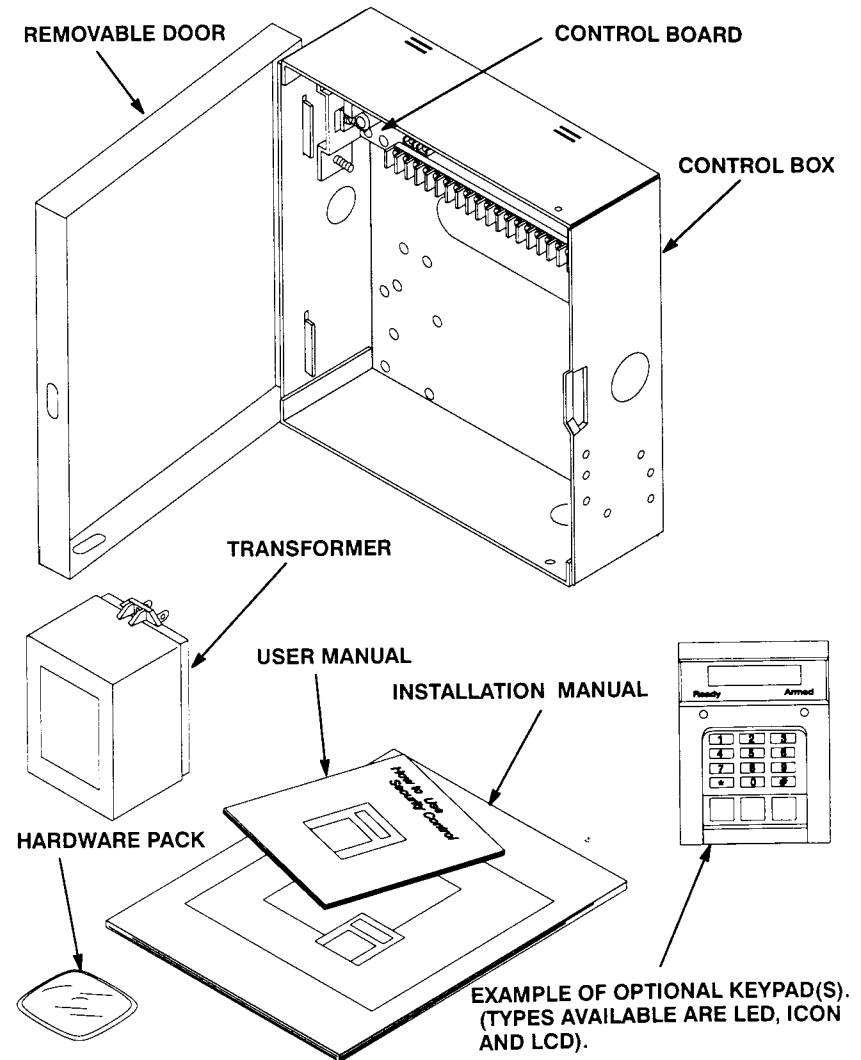

FIGURE 1-2. Z950 Parts List

1.3 Mounting And Wiring Preparation

Remove all packing material and compare the system components with those in FIGURE 1-2, page 1-3 to familiarize yourself with the part names. Mount the control in a secure, dry location where an ambient temperature inside the control box can remain at 32° to 120° Fahrenheit (0° to +49° Celsius). Remove control box knockouts that best suit your wiring needs and mount the control using the upper center slotted hole and two lower mounting holes. Install and connect all necessary wiring for the power transformer, detection loops, keypads and siren outputs. Refer to FIGURE 1-4, page 1-6.

1.4 Wiring

Earth Ground

In order for the control's lighting and transient protection to be effective, we recommend the control be connected to an earth ground. Finding a proper ground path can affect selection of the control mounting location since the ground wire should be as short and straight as possible.

An ideal ground for a security system is a unified earth ground. In this type ground, the power line, telephone, and security system ground rods are bonded together. This eliminates the possibility for Step Voltage Blowout, a frequent problem occurring during lightning strikes. Refer to FIGURE 1-3, page 1-5.

Reference NEC Article 250 for proper grounding requirements.

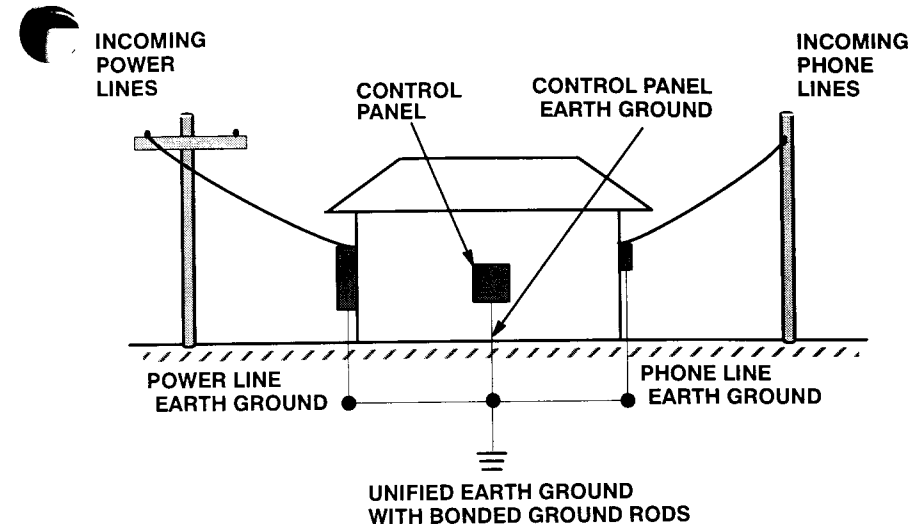
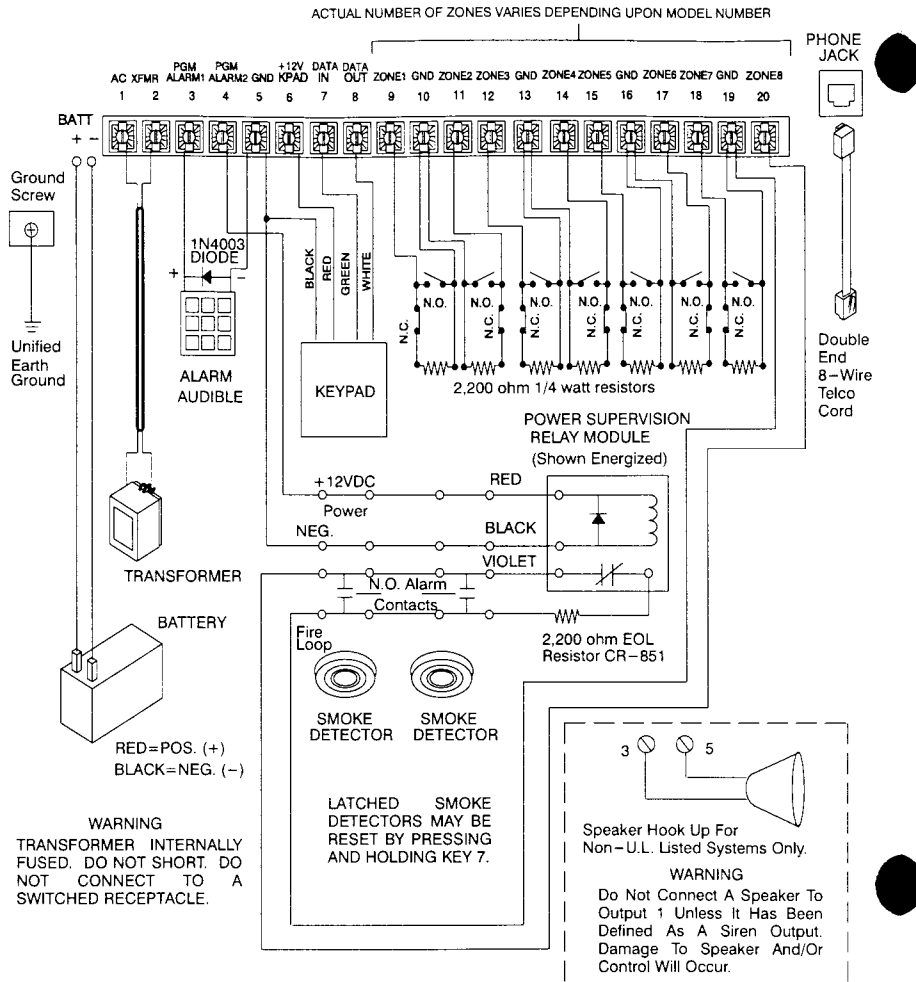

FIGURE 1-3. Unified Earth Ground

Follow these steps to earth ground the control:

1. Crimp the ground wire lug to the control end of a minimum 14 gauge solid ground wire.
2. Remove the lower left control board mounting screw, insert it through ground wire lug and re-install, securing the ground wiring.
3. Run the earth ground wire and attach to a bonded earth ground. Be sure to keep wire runs short and avoid 90° or sharp turns. Use a minimum radius of 8 in. for bends.
4. Remember, ground wires must be routed separately. Be sure to route toward the earth. Always use 8 ft. copper clad ground rods and never run parallel to metal without properly bonding to that metal.



Battery – 12V 4AH to 7AH, Voltage 13.6–13.8V, Max. Charge Current 400mA, Quiescent Charge Current 20mA

Transformer – 16.5V/35VA min. U.L. Class II 50/60 Hz.

Smoke Detector – ESL #449 AT U.L. Listed or Equivalent

Power Supervision Relay Module – U.L. Listed ESL Model 204–12/24V or Equivalent. One per each fire loop zone.

Burglar/Fire Alarm Audible – U.L. Listed Wheellock Horn #34T12 (85dB)

FIGURE 1–4. Suggested U. L. Household Burglar Alarm And/Or Fire (ff) Alarm Hookup (Shown With Zone 8 Defined As Fire)

Table 1–1. Control Board Terminal Descriptions

TERMINAL	FUNCTION	DESCRIPTION
1	AC Input	Connect 16.5 VAC 35 VA U.L. Class II transformer using 18 gauge minimum, 2 conductor wire. Do not exceed 50 feet. Do not plug in until all wiring is complete.
2	AC Input	
3	Programmable Alarm Output 1	(+) 10.0 - 12.2 VDC for powering devices upon alarm or other conditions as defined by Function 32.
4	Programmable Alarm Output 2	(+) 10.0 - 12.2 VDC for powering devices upon alarm or other conditions as defined by Function 33.
5	Common Negative	Negative termination for devices powered by terminals 3, 4, and 6. (Same as terminals 10, 13, 16, and 19.)
6	Keypad/Auxiliary Power 1 (+)	(+) 10.0 - 12.2 VDC for powering keypads, motion detectors, and other accessories.
7	Keypad Data In	Connect keypad green leads to this terminal.
8	Keypad Data Out	Connect keypad white leads to this terminal.
9	Zone 1 Loop (+)	Each loop requires a 2,200 Ω end-of-line resistor. Closed or open circuit contacts can be connected to each loop. A common negative is shared between each group of two (2) zones. *Actual number of zones varies depending upon model number.
10	Zone 1 And 2 Common (-)	
11	Zone 2 Loop (+)	
12	Zone 3 Loop (+)	
13	Zone 3 And 4 Common (-)	
14	Zone 4 Loop (+)	
15	Zone 5 Loop (+)	
16	Zone 5 And 6 Common (-)	
17	Zone 6 Loop (+)	
18	Zone 7 Loop (+)	
19	Zone 7 And 8 Common (-)	
20	Zone 8 Loop (+)	

NOTE: Terminals 3 and 4 are overload protected at 1.6 amps (F2). Terminal 6 is overload protected at 1.6 amp (F1). Combined alarm condition current should not exceed 3.0 amps Max. combined continuous current drain should not exceed 900 mA.

NOTE: Refer to Section 5 for U.L. Listed System Requirements

Standby Battery And Transformer

The control is powered by a 16.5 volt 35VA U.L. Listed Class II plug-in transformer. Follow the wiring instructions shown in FIGURE 1-4, page 1-6.

A 12 volt, sealed lead acid rechargeable battery (4 amp hour minimum) must be installed to provide primary power back up. The float charge voltage for the battery is set for 13.8 volts at 400 milliamps (mA) maximum, while the system is delivering its rated continuous output current. Current in excess of 400 mA can be delivered to the battery if the system is delivering less than the rated power. The battery charging current is limited through a 5 ohm resistor.

The battery automatically takes over and provides power in the event of an AC power outage. If the AC fails for an extended period and the battery voltage drops below 11.2 volts, the low battery detector will activate and cause the keypad pre-alarm to beep, the trouble indicator to light and the digital communicator to report to the central station (if so programmed). The beep can be silenced by pressing the Reset (*) key. Press and hold key 7 to clear the trouble indicator after the battery has been recharged.

If during a loss of AC power, the battery should drop below 7.5 volts, the microprocessor will shut down, but there will still be auxiliary equipment drain on the battery. An MPI-267 Power Disconnect Module can be added to disconnect the battery and protect it against deep discharge. It also provides an ON/OFF power switch.

1. To install the battery, place battery in enclosure. Make sure the AC transformer is disconnected.
2. Connect the black battery wire to the negative (black) battery terminal marked “-”.
3. After wiring of the control is complete, connect the red battery lead to the positive (red) battery terminal marked “+”.

CAUTION

A REVERSE CURRENT DIODE PROVIDES SOME PROTECTION TO THE ELECTRONICS IF THE POWER LEADS ARE ACCIDENTALLY REVERSED. DO NOT LEAVE LEADS REVERSED. OVERHEATING OF RESISTOR R8 WILL RESULT.

Hardwire Zone Inputs (Terminals 9 – 20)

The system provides up to eight (8) individually programmable class B end-of-line supervised detection zones depending upon model number. Each hardwired zone can be configured as a burglar, 24-hour Auxiliary A (Fire *ff*), 24-hour Auxiliary B (Holdup), 24-hour Auxiliary C or communicator report only zone. In addition, a single zone can be programmed to allow system key switch operation. Each of the zones can be further defined with various options and sub-options. The Zone Planning Guide on page 3-4 assists in planning each zone.

In order to function properly as a class B supervised circuit, a zone must have a 2,200 ohm 1/4 watt resistor installed at the end furthest from the control. This configuration allows both open and closed circuit contacts to be used on the same loop and provides a high degree of protection against compromise or tampering. The control constantly measures the resistance on a class B zone and is able to determine by a proper reading of approximately 2,200 ohms that a zone is secure and intact. It can respond differently to a high resistance (loop open) versus a low resistance (loop short).

For example, a class A Fire (*ff*) zone reacts with a supervisory/trouble condition when opened and an alarm when shorted. Supervisory/Trouble is a programmable sub option for each of the other zone types. There is even a choice of whether a trouble condition should occur upon an open or short (non-Fire zones only). For more information see “Supervisory/Trouble Sub-option” in Chapter 3. The system comes equipped with eight 2,200 ohm, 1/4 watt resistors, one for each zone. The resistors are color coded with bands — red, red, red, and either gold or silver.

NOTE

Any loop short or open will greatly change circuit resistance and violate the zone. The resistor must be placed at the end of the loop.

Fire zones require use of U.L. Listed Model CR851 end-of-line resistor.

Connect a typical installation configuration as follows:

1. Connect all alarm sensors to the zone wiring as per the instructions provided by the individual sensor manufacturer and FIGURE 1-4 on page 1-6.
2. Connect each zone wire to the appropriately labeled terminals according to FIGURE 1-4. Each zone has an input terminal and a common (negative) return. Please note that a negative terminal is shared by two zones and that all negatives are common to each other.
3. If 12 volt D.C. powered detection devices such as motion sensors are being installed, refer to "12 VDC Outputs," on page 1-14.
4. Define each zone utilizing the "Zone Planning Guide" on page 3-4 and program the zone definition value into the corresponding function (see Section 3).

24-Hour Auxiliary Zones

Zones defined as 24 hour Auxiliary A, Auxiliary B, or Auxiliary C are commonly used for Fire (*ff*), Holdup or Auxiliary C inputs, however, they can also be used for other devices requiring 24 hour supervision. A 24 hour Auxiliary A defined zone provides an alarm upon a loop short utilizing open circuit sensors and provides a supervisory/trouble upon an open or break in the loop. Auxiliary B and Auxiliary C defined zones can also be programmed with the supervisory/trouble sub-option.

24-Hour Communicator Report Zones

Communicator report only zones provide no keypad indication or panel outputs and are therefore intended for simply reporting conditions from temperature and/or water sensors.

Key Switch Zone

The system can be armed/disarmed with one or more momentary or maintained (shunt) contact key switch(es), however, only one zone may be programmed as a key switch zone.

When the momentary key switch is held closed for one second, the pre-alarm will beep to indicate that the key exchange is acknowledged. When the key switch closure is released, the control will arm/disarm. If program Function 305 is enabled, holding the key switch closed will change the interior on/off mode once each second, then after the interior status is displayed, releasing the key switch will arm the system. If programmed with the supervisory/trouble definition, a tamper switch can be wired to disable the key switch arm/disarm capability if the zone is violated.

If a zone is programmed for maintained key switch usage, the keypads will be disabled from either arming or disarming the control. Only the key switch defined zone can be used to arm or disarm.

NOTE

Do not define a maintained key switch zone for supervisory/trouble conditioning.

Keypad Wiring (Terminals 5, 6, 7, And 8)

The keypad connects to the control terminals using a four conductor cable. Four conductor, 22-gauge solid or larger jacketed cable is satisfactory for this hookup; however, stranded wire provides additional resistance to bending and breaking. A shielded cable with the control end connected to an earth ground provides additional protection from lightning. Connect the four keypad wires as indicated in Table 1-2 page 1-13.

The total number of keypads that can be used per system varies, depending upon the total current drain from terminals 3, 4, and 6. To determine the maximum number of keypads per system, add 50 mA for each keypad to be used. Maximum line resistance 47 ohms. This total should not exceed the limits as indicated in Table 4-1, page 4-4.

The keypads shown below may be used with the Z950 control panels.

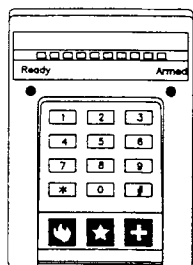

Z800R8

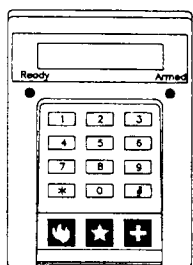

Z800ST

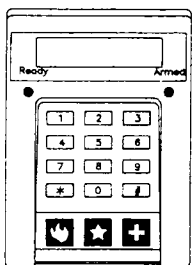

Z800IC

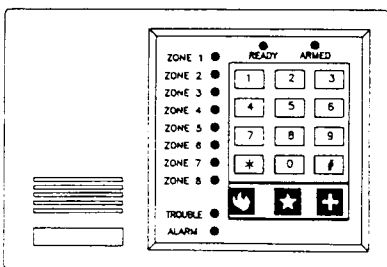

Z800RE

FIGURE 1-5. Z950 Keypad Compatibility Chart

Table 1-2. Z950 Keypad Wiring

Keypad Wire Color	Function	Z950 Control Terminal
Black	Negative	5
Red	Positive (+12 VDC)	6
Green	Data In (Remote)	7
White	Data Out (Remote)	8

Troubleshooting

If a keypad is incorrectly wired, the following symptoms will appear.

- Red wire removed or cut: No keypad indicators. Sounder pulses rapidly. Keypad will not accept key entries.
- Black wire removed or cut: All keypad indicators flash rapidly. Sounder pulses rapidly. Keypad will not accept key entries.
- Green wire removed or cut: Trouble indicator lights steady. Keypad will not accept key entries.
- White wire removed or cut or green and white wires reversed: Keypad indicators scroll from left to right.

Overload Protection

F1

F1 is a 1.6 amp overload protector that protects terminal 6. In the event of an overvoltage spike, the keypad becomes inactive but the communicator, if programmed, will report a Low Battery/Output Overload condition to the central station.

F2

F2 is a 1.6 amp overload protector that protects terminal 3 and 4. In the event of an overvoltage spike, the keypad's Trouble indicator will illuminate. Upon pressing and holding the 2 key for three seconds, the Zone 2 indicator (Low Battery/Output Overload) will illuminate. The communicator will report a Low Battery/Output Overload condition to the central station (if so programmed).

12 VDC Outputs

The control is supplied with two high power programmable outputs, two low power programmable outputs, and one auxiliary keypad power output. For U.L. installations, outputs 3 and 4 should only be used for supplementary devices.

Programmable Output 1 (Terminal 3, High Power)

Control terminal 3 is a +12 VDC terminal protected by overload protection F2 and is programmable using Function 32. This output can be programmed as a siren output, using the built-in driver. (Refer to Programming Output Configurations on page B). For a non-U.L. listed system, connect a 30 watt speaker between terminal 3 and negative terminal 5. (Refer to FIGURE 1-4, page 1-6).

Programmable Output 2 (Terminal 4, High Power)

Control terminal 3 is a +12 VDC terminal protected by overload protection F2 and is programmable using Function 33.

Programmable Output 3 (Terminal P3, Connector J2)

Terminal P3 of Connector J2 is a +12 VDC terminal limited to 40 milliamps maximum and is programmable using Function 34.

Programmable Output 4 (Terminal P2, Connector J2)

Terminal P2 of Connector J2 is a +12 VDC terminal limited to 40 milliamps maximum and is programmable using Function 35.

Keypad Power/Auxiliary 1 (Terminal 6)

Keypad Power/Auxiliary 1 is used to supply +12 VDC power for keypads. This output is protected at 1.6 amps by overload protection F1. This output can also be used to supply auxiliary power for motion detectors and other devices provided the total current draw does not exceed limits set by Table 4-1, page 4-4.

Keypad Activated Panic Zones

The control has three keypad activated panic zones. Three panic keys are provided on the keypads (from left to right) for Auxiliary A (Fire *ff*), Auxiliary B (Holdup), and Auxiliary C alarms. Each zone is activated by pressing its designated key and holding for three seconds (or pressing at least twice within three seconds). If desired, the control can be programmed to respond to single momentary keypress by programming a value of 0 into Function 315.

Telephone Line Connection

The telephone line runs through a line seizure relay within the control. Whenever the control is idle, this relay completes the connection. When the control needs to communicate with the central station, this relay disconnects the house phones from the system, leaving only the communicator connected to the incoming lines. This prevents communication interruption caused by picking up of a house telephone within the protected premises. For proper installation and to meet FCC requirements, an approved USOC RJ-31X telephone jack and a mating 8 pin modular direct connect cord must be installed (see FIGURE 1-6 on page 1-16). This equipment provides isolation and disconnection points between the local telephone system and the control's digital communicator for telephone company troubleshooting. When ordering either jack, the telephone company will need the following information:

- Required jack: USOC RJ-31X
- The telephone number of the line where the jack is to be installed
- Requested location where jack is to be installed
- Ringer Equivalence Number: 0.0B

NOTE

The Ringer Equivalence Number (REN) is useful to determine the quantity of devices you can connect to your telephone line and still have all of those devices ring when your telephone number is called. In most cases, but not all areas, the sum of the RENs of all devices connected to one line should not exceed 5.0. To be certain of the number of devices suitable for connection to a line in your area as determined by the REN, contact the local telephone company. Refer to the inside back cover of this manual for FCC Compliance and additional telephone company information.

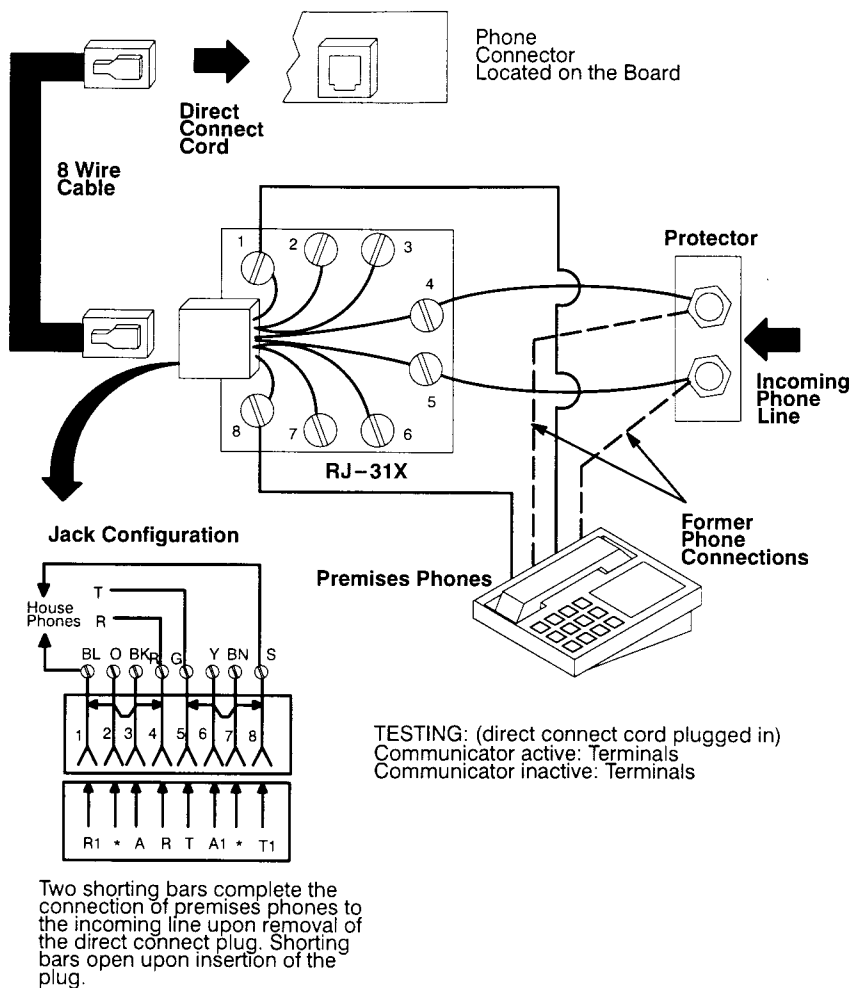

FIGURE 1-6. Telephone System Connection

Operating The System 2

2.1 Powering Up The Control

Before powering up the control, make certain that all connections are complete. This section assumes that the preceding sections have been read completely, that all wiring is complete, and the system is ready to be powered up.

Procedure

First, verify that the AC transformer and battery are connected. The control will power up with DC current only, but the Trouble indicator will light to indicate an AC Failure condition. The keypads will now display system status and emit a 2-second tone. If a keypad does not power up properly, pressing the Reset (*) key will reset the keypad microprocessor and allow it to begin working properly.

WARNING

THE PANEL HAS A SPECIAL MECHANISM FOR IDENTIFYING ITS CONFIGURATION. AFTER DEFAULTING A PANEL, ALWAYS POWER UP ON AC FIRST AND THEN ON BATTERY TO ENSURE PROPER CONFIGURATION.

Watchdog Monitor

The watchdog monitor is a circuit that constantly monitors the operation of the microprocessor. If the control does not power up properly or if an internal problem occurs, the watchdog monitor will perform a restart of the microprocessor. Each time power is applied, a ROM and EEPROM check is automatically made and the system begins at the same operating condition it was in with the following exceptions:

- If the system is armed, the control will ignore all burglar defined zones for 15 seconds (or as programmed in Function 308) once the watchdog restarts the microprocessor.
- If the system is in alarm, the alarm output will cease and the control will re-arm.

- If the system is communicating, the communication will be lost with the exception of alarm reports. Alarms are stored in nonvolatile memory and will be re-transmitted.
- The automatic communicator test clock will be reset to zero. If the system is programmed for test reporting, the test report will be sent when the system resets, thus notifying the central station of an out of sequence test. The test reporting code is optional and is disabled from the factory.

Automatic System Diagnostics Upon Power Up

Control panel memory is checked each time the control is armed/disarmed and during automatic communicator tests. If a memory error is detected, a trouble condition is annunciated by the control, either by scrolling LEDs or a continuous beeping at the keypad (the Trouble indicator will be illuminated). If an error is indicated, consult the Function Map to determine change(s) in information. Seek technical support from a qualified service technician as necessary. Keypad beeping can be silenced by pressing the Reset (*) key; the Trouble indicator will clear when program mode is exited.

Processing Alarms Following Total Power Loss

If a total power loss occurs (both AC and battery) while the control is armed, the control will ignore all burglar defined zones for 15 seconds once the power is restored. The delay is to allow time for devices such as motion detectors and glass break sensors to power up and stabilize. Delay time can be increased to 181 seconds (Function 308) if necessary to accommodate detectors requiring longer stabilization time. If a total power loss occurs while the digital communicator is transmitting, hardwire activated zone alarms stored in the EEPROM will be reported when power is restored.

NOTE

Keypad activated alarms as well as supervisory/trouble, opening/closings, restorals, cancellations, and test reports are not stored in EEPROM and therefore will be lost in the event of a total power loss.

NOTE

After defaulting a panel, always power up on AC power first. This correctly identifies the control type to the microprocessor.

2.2 The Keypad

The keypads were designed with ease of user operation in mind. A red "Armed" indicator blinks upon exit delay and lights steady when the control arms. A green "Ready" indicator lights steady if all hardwired zones are secure (even if faulted zones are shunted) and goes out if one or more zones are faulted. Each hardwired zone has a corresponding zone status indicator. If the green Ready indicator is off, the corresponding faulted zone indicator(s) will illuminate. If a zone is shunted, the corresponding zone indicator will blink, even if shunted by turning the interior defined zones off (see Interior ON/OFF). A separate Alarm indicator illuminates simultaneously with the alarmed zone indicator to provide alarm memory identification. A Trouble indicator lights if service is required. Arming and disarming is accomplished by entering a four digit code. Each code can include any digit sequence from 0001-9999. Up to eight User Authorization Codes can be programmed, one of these being the Master User Authorization Code. User Authorization Code one is the Master User Authorization Code. This code is also used to provide access to User Level Programming. Any code can be further defined as a High Security Arm/Disarm Code. When the system is armed with a High Security Arm/Disarm Code, the system cannot be disarmed by a non-high security code.

Keypad Power Up And Supervision

Upon installation and power up, each keypad should be initialized with the control by manually pressing the Reset (*) key. Then, if a keypad data wire is tampered with, poorly wired, or broken, or if a keypad is disconnected from the main control, the Trouble indicator on any remaining keypads will illuminate. Pressing the 2 key (on an active keypad) and holding for three seconds will cause the Zone 3 Supervisory indicator to light. The digital communicator can also be programmed to report this condition to the central station. If the faulted keypad still has power connected, the keypad indicators will scroll for local identification.

User Operation

Arming/Disarming

Arming and Disarming of the control is performed by simply entering an authorized four digit user code. Upon arming, the keypad sounder will beep during the programmable exit delay time (Function 15). The sounder will beep twice as fast during the last ten seconds of the exit delay time. Upon entering the premises through a delay defined zone, the keypad

sounder will emit a steady pre-alarm tone during the programmed entrance delay time (Functions 13 and 14). The sounder beeps slowly during last ten seconds of entrance delay time. The entrance and/or exit delay annunciation can be disabled if desired by programming odd time values. The arm/disarm codes are also used to reset all Auxiliary alarms and keypad activated zones. User codes (Functions 1–9) are programmable only through User Level Programming.

Alarm Status

If an alarm occurs, the Alarm indicator remains lighted until manually reset. If the alarm was triggered through a hardwired zone, the corresponding zone indicators will also light. For example, if an alarm occurs on Burglar Zone 4, the Alarm Zone 4 indicators will illuminate. Upon disarming the control, these indicators will remain lighted. Pressing the Reset (*) key will turn the Alarm indicator off. If the alarm was triggered through one of the keypad activated zones, the red Alarm indicator will light. Entering a valid user code will clear the alarm.

Manually Resetting Alarms

Burglar alarms: The burglar alarm can be reset by entering a valid user code. The communicator will continue to report the condition to the central station as programmed unless programmed to abort upon disarming. The Alarm indicator will remain lighted until reset by pressing the Reset (*) key.

Auxiliary A (Fire ff) Alarms: Pressing the Reset (*) key will silence the keypad sounder. The Auxiliary A (Fire ff) alarm which can be provided through the Programmable Output will also cease. The Alarm indicator will remain illuminated and the communicator (if programmed) will continue to report to the central station. Entering a valid user code will clear the alarm.

Auxiliary B (Holdup) Alarms: Pressing the Reset (*) key will silence the keypad sounder. The Auxiliary B (Holdup) alarm, which can be provided through the Programmable Output will not be reset by pressing this key. Entering a valid user code will reset the alarm.

Auxiliary C Alarms: Pressing the Reset (*) key will silence the keypad sounder. The Auxiliary C alarm, which can be provided through the Programmable Output will also cease. The Alarm indicator will remain illuminated and the communicator (if programmed) will continue to report to the central station. Entering a valid user code will reset the alarm.

Keypad Activated Panic Zone Operation

The control has three keypad activated zones. Each zone is predefined for the type of alarm it can initiate and is activated by pressing a designated key. For added protection against false alarms, the control is programmed to ignore momentary keypresses and requires a three second maintained keypress (or at least two momentary key presses within three seconds). The left key is predefined to initiate an Auxiliary A (Fire ff) alarm, the center key can initiate an Auxiliary B (Holdup) alarm, and the right key an Auxiliary C alarm. Self adhesive labels are included with the keypad for labeling these keys with symbols. Any or all keypad zones can be disabled through programming. Programmable Outputs can be programmed to provide + 12 VDC upon activation, and the communicator can also be programmed to report (refer to Table 2-1 on page 2-8).

When a keypad zone is activated, the keypad beeps and the Alarm indicator lights. The keypad can be silenced by pressing the Reset (*) key. If the zone is defined as an Auxiliary A or C zone, pressing the Reset (*) key will also silence the assignable output (terminal 3) if so assigned. The alarm can be reset by entering a valid user code. The keypad activated zone can be programmed to report the alarm to the central station. Auxiliary B can be programmed to be visually and audibly silent at the keypad when activated.

Zone Shunting (Bypassing)

Hardwired burglar zones can be manually bypassed by pressing the Bypass (#) key followed by the number of the zone to be shunted. Auxiliary A, B, and C, zones can be defined with the sub-option to allow them to be shuntable also. The control must be disarmed for shunts to be enabled. When zones are shunted, the appropriate zone indicators will blink continuously. Pressing Bypass (#) followed by 0 will bypass all faulted zones. Pressing Bypass (#) followed by the number of a shunted zone will remove the shunt. Pressing Bypass (#) followed by 9 will remove all shunts. When the control is armed, the shunted zone indicators will only blink for the first 30 seconds after the exit delay expires. To get the shunted zone indicators to blink during the armed period, enable Function 301 (Permanent Force-Arm). Zone shunting is disabled through programming.

Installer Diagnostic Features

Certain keypad keys provide access to special features designed primarily for use by the installer. However, the installer can at his or her discretion, explain certain available features to the user when necessary. Table 2-2 on page 2-9 lists these features. Diagnostic information is obtained through the keypad by pressing specific keys. Information is displayed through combinations of illuminated indicators. Features accessed through keys 4, 5, 6, 7, 8 and Reset (*) can be disabled through installer programming. Table 2-1 on page 2-8 aids in defining specific trouble conditions.

Identifying Trouble Conditions

If a trouble condition exists, a Trouble indicator will illuminate on the keypads. Pressing and holding the number 2 key for three seconds will cause one or more of the zone indicators to light. Each zone indicator corresponds to a specific Trouble condition. This procedure is simple enough to be performed by the user and communicated to the installer over the telephone for diagnosis. Table 2-1 explains the indicated conditions.

If the Trouble indicator is lighted, press and hold the 2 key for three seconds. The keypads will beep three times and one or more zone indicators will light to indicate the nature of the Trouble condition as explained in Table 2-1.

Alarm Memory Retrieval

When an alarm condition occurs, the control stores a record of the alarm in memory. This information can be retrieved even after the alarm has been reset and the keypad Alarm indicator is extinguished. To obtain a display indicating the most recent alarm, press and hold the 3 key for three seconds and observe the lighted indicators. The display will return to the normal status mode after eight seconds.

Event History Buffer

The control features a built-in 20 event buffer which can only be viewed by the installer or through the upload/download software. The Event History Record for the control can be found on page L.

READY INDICATOR

If ON: The system is ready to be armed.

If OFF: The system is not ready to be armed. One or more unshunted zones are not secure.

ARMED INDICATOR

If ON: Burglar system is armed.

If OFF: System is disarmed.

If BLINKING: Exit delay is active. Indicator will light steady when the control arms.

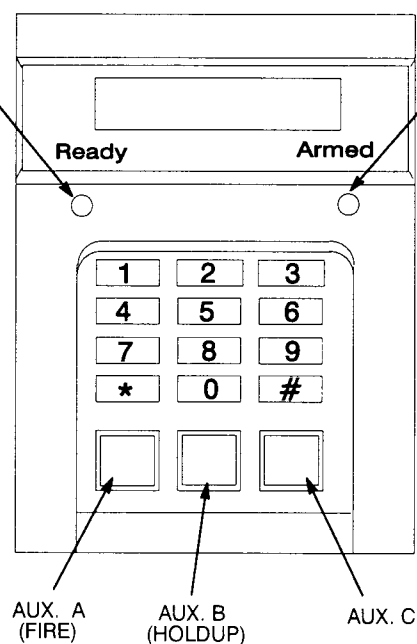

FIGURE 2-1. Keypad Indicators

Table 2-1. Trouble Definition

LIGHTED INDICATOR	INDICATED CONDITION/CORRECTIVE ACTION
Zone 1	AC Power Failure. Check transformer terminals 1 and 2 for presence of 16.5 VAC (no load) power.
Zone 2	Low Battery/Overload Protection. Check F1, F2, and condition of standby battery.
Zone 3	Supervisory/Trouble. A supervisory defined zone is shorted or open.
Zone 4	Fail To Communicate. The control attempted to communicate with the central station but failed. Press the "Reset (*)" key to silence the keypad sounder.
Zone 5	Memory Error. Program information stored in the EEPROM has changed. See "Powering Up The Control."
Zone 6	Missing Keypad. A keypad data wire has been removed from the control.
Zone 7	None
<i>The following conditions do not require the "Trouble" indicator to be lighted. Press the 2 key and hold for three seconds in the same manner as above to obtain the following ON or OFF indications:</i>	
Zone 8	Chime ON. The chime (monitor) feature is active.
Alarm	None
Ready	Interior OFF. The interior defined zones are turned OFF (bypassed). They can be reinstated by pressing and holding the number 4 key for three seconds. Turning the interior off can also automatically disable the entrance delay, if so programmed (Function 311).
Armed	Delay OFF. The Entrance Delay assigned to Entrance Delay 1 and 2 defined zones has been turned OFF. Delay can be reinstated by pressing and holding the 5 key for three seconds.

Table 2-2. Special Keypad Features

KEY NUMBER	FEATURE PROVIDED
2	Trouble Status: If a problem exists within the system, a keypad indicator labeled "Trouble" will light. Pressing and holding this key for three seconds further defines the trouble. This function ends automatically after 8 seconds.
3	Alarm Memory: Pressing and holding this key for three seconds will obtain a display identifying the zone that triggered the last alarm condition. Programming Function 011 clears Alarm Memory.
4	Interior ON/OFF: All interior defined zones can be shunted by pressing and holding the number 4 key for three seconds. Corresponding zone indicators will blink to indicate zones are shunted. These zones can be returned to operation by repeating the process. Entrance delay can be disabled whenever the interior is turned off depending upon programming of Function 311. Zones can be automatically defaulted to on or off (along with the delay if so programmed) depending upon programming of Function 310. The Interior ON/OFF key is disabled through installer programming (Function 320).
5	Delay ON/OFF: All delay defined zones can be made instant by pressing and holding the 5 key for three seconds. Key 5 can be disabled using Function 320.
6	Chime: Pressing and holding the number 6 key for three seconds will activate the Chime (Monitor) feature. The keypads will beep three times to signify that the chime has been turned on. When enabled, the keypads will beep twice whenever a perimeter burglar defined zone is violated (with the control disarmed). The chime feature can be disabled through programming (Function 321) if desired.

Table 2-2. Special Keypad Features (Cont'd)

KEY NUMBER	FEATURE PROVIDED
7	Switched Power Interrupt: Press and hold this key for three seconds to temporarily interrupt the power from any outputs programmed as Switched Smoke Power. The power will be interrupted for five seconds to reset smoke detectors and other latching devices. Fire zones do not automatically reset after a fire alarm. This feature can be disabled through programming (Function 322). The "7" key also activates a Battery Test which can be used to clear a Low Battery Trouble Indicator.
8	Test: Press and hold this key for three seconds to enter TEST mode. To test the Bell for one second, press the "1" key and the "Reset (*)" key. To test the dialer, press the "2" key and the "Reset (*)" key. A dialer test is then performed with the central station (using Zone 1 dial configuration). The READY light will blink until the dialer test is completed or until the TEST mode is exited. If the dialer test fails, the keypad will indicate a trouble condition. Each time that a zone is violated while in the TEST mode, the corresponding indicator will light and remain lit until the TEST mode is exited. To exit TEST mode, press the "Reset (*)" key. This feature can be disabled through programming (Function 323).
9	Program: Press and hold for three seconds, then enter the Master User or Installer Programming Code to enter the programming mode. See Section 3 for more information.
0	Access: Press and hold for three seconds, then enter assigned user code to provide output for Access. User code must be assigned a configuration digit of 2, 3, 5, or 7 (Function 024-031).
*	Reset: Used to clear/reset improper key entries/alarms.
#	Bypass (Zone Shunting): Zones can be bypassed by pressing the "Bypass (#)" key followed by the zone number (1-8). Pressing "Bypass (#)" then 9 clears all shunts. This feature is disabled through Function 319.

Programming The Control 3

All programming is stored in nonvolatile EEPROM memory. The control is shipped with a factory (default) program already installed. All programming options are referred to as Functions. User Level Programming provides access to Functions 1-23 pertaining primarily to everyday operation by the end user.

Installer Level Programming provides access to all installer level programming functions and to user level programming Functions 9-23. Both levels of programming can be entered locally from any keypad.

3.1 Installer Level Programming

Installer Program Authorization Code

To enter the programming mode, press the 9 key and hold for three seconds. The keypad will beep three times to signify acceptance. Now enter the Installer Program Authorization Code (96321 at default). All keypad indicators will blink continuously.

NOTE

If the first four digits of the Installer Program Authorization Code are programmed the same as any User Authorization code (Functions 1-8), the Installer Program Code will be inoperative.

Entering Installer Level Programming Upon Power Up

Upon power up, the Installer Level Programming Mode can be entered directly by entering "0852*". This must be performed within 60 seconds after applying power to the control. The power up method can also be used when the Installer Program Authorization Code is unknown.

Three Minute Programming Timer

A three minute timer is started upon entry into the programming mode. If no keys are pressed for a duration of three minutes while in the programming mode, the keypad will emit a two-second error tone and the control will return to the normal operation mode.

Program Functions

All programming options are called Functions. Each contains a specific value, which serves as an instruction to the control. Programming changes are accomplished by entering new values into chosen functions. The allowable range of a value contained in each function varies according to the specific type and purpose. For instance, most of the timer related functions (entry/exit, alarm cutoff, etc.) deal with either seconds or minutes and have a range of 1–255. Functions that are associated with the digital communicator, such as the account number, report codes, and telephone number, have a range of 1–15. Many functions are questions requiring a simple yes or no response. Since the microprocessor accepts only numbers, answers to these type functions must be in the form of a 0 for No or a 1 for Yes. The Program Function Map and Programming Functions and Descriptions sections provide additional information about each function as well as the allowable range of values.

The (#) And (*) Keys

The (#) key and the (*) key used in *programming mode* function as Find and Store. During normal system usage, the # key functions as Bypass and the Reset (*) key functions as Reset.

While in the programming mode, any program function can be accessed by pressing the desired function number using the numeric keys and then pressing the Find key. This also serves as a Next key. When pressed without first pressing any of the number keys, the Find (#) key will advance programming to the next consecutive function.

Example: Pressing 4 + 5 and then Find jumps to program Function 45 and displays its current value.

After finding a program function, the value (data) it contains will be displayed on the indicators. The value can be changed by pressing the desired new value using the keys 0–9 and then pressing the Store (*) key. This key also serves as a Quit key. When pressed without first pressing any of the number keys, the Store key will automatically exit the programming mode.

Example: Pressing 7 + 3 and then Store changes the current program Function value to a value of 73.

Value represented by each lighted indicator
(1, 2, 4, 8, 16, 32, 64, and 128 respectively)

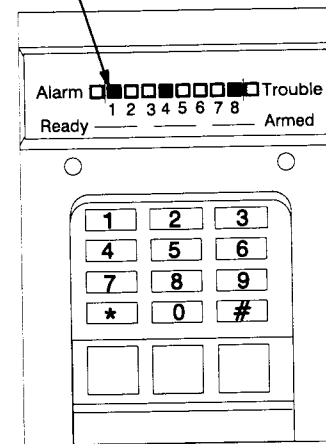

Lighted Indicator	Value Represented
Zone 1	1
Zone 4	8
Zone 8	128
Total Value	137

FIGURE 3–1. Reading The Value Of A Function

Zone Planning Guide

Zones are programmed by selecting the desired zone type and definitions using the Zone Planning Guide on page 3–4 as a worksheet. Each definition has a specific value that should be programmed into the function for that zone.

Program Function Map

The Program Function Map, pages A through L, provides a list of each Function, its factory default value, and a blank space to write in any changes still to be determined. The map can be removed from the book and left inside the control for future reference.

Exiting the Programming mode

Pressing the Reset (*) key twice exits programming mode.

ZONE TYPE	DEFINITION	VALUE	ZONES														
			01	02	03	04	05	06	07	08							
BURGLAR LOOPS*	ENTRY DELAY 1	=0															
	INSTANT	=1															
	SILENT INSTANT	=7															
	ENTRY DELAY 2	=8															
	INTERIOR	=16															
	NON-SHUNTABLE	=32															
	SLOW RESPONSE	=64															
* SUPERVISOR/TBL	=128																
TOTAL VALUE FOR BURGLAR LOOPS																	
AUXILIARY "A" (f) FIRE		=2															
	SHUNTABLE †	=32															
	SLOW RESPONSE	=64															
	NO AUTO SMOKE RESET**																
TOTAL VALUE FOR AUXILIARY "A"																	
AUXILIARY "B" (HOLDUP)		=3															
	NO AUX. "B" ALARM OUTPUT	=8															
	NO ALARM MEM OUTPUT	=16															
	SHUNTABLE †	=32															
	SLOW RESPONSE	=64															
	SUPERVISOR/TBL	=128															
TOTAL VALUE FOR AUXILIARY "B"																	
AUXILIARY "C"		=4															
	SHUNTABLE †	=32															
	SLOW RESPONSE	=64															
	SUPERVISOR/TBL	=128															
TOTAL VALUE FOR AUXILIARY "C"																	
KEYSWITCH †† 1 ZONE ONLY		=5															
	MAINTAINED TYPE	=16															
	SHUNTABLE	=32															
	SUPERVISOR/TBL	=128															
TOTAL VALUE FOR KEYSWITCH																	
COMMUNICATOR REPORT ONLY		=6															
	SHUNTABLE	=32															
	SLOW RESPONSE	=64															
	SUPERVISOR/TBL	=128															
TOTAL VALUE FOR COMMUNICATOR REPORT																	
FUNCTION # FOR ENTERING TOTAL VALUE			41	42	43	44	45	46	47	48							

FIGURE 3-2. Zone Planning Guide

Installer Level Programming Example



1. Press 9 and hold for three seconds. Three beeps.
2. Enter the Installer Program Code. (96321 at default) All indicators flash.

NOTE: If Auto Answer is enabled, the Armed indicator will light steady.



3. Enter the desired Function number (1-3 digits). The current Function value will be displayed through the indicators.
4. Press "FIND". Two beeps. The value of the selected Function will be displayed through the indicators.

NOTE: Ready and Armed indicators continue to flash alternately throughout the programming mode.



5. Enter the new value. (A 1 represents "Yes" in this example. Possible entries vary for different Functions.)
6. Press "STORE". Two beeps. The new value is now stored in the EEPROM.



7. Press "NEXT" to step to the next location or enter a new Function number followed by this key to "FIND" the selected Function.
8. Press the "*" key twice to exit the programming mode.

FIGURE 3-3. Installer Level Programming Example

Restoring the Factory Default Program

The control's factory default program can be easily restored at any time. Restoring the factory defaults automatically resets all installer level and user level program functions to the original default (factory pre-programmed) values. Restoring the default settings provides a quick means of erasing any bench testing programming prior to final installation. If the User Code is forgotten and restoring the entire program to default values is not desired, it can be restored individually through program Function 333. Refer to the Function Map for a complete listing of the default values.

NOTE

If the anti-takeover option has been programmed by TRANSPORT-PC, it will not be possible to default the telephone numbers or account codes.

1. Enter the installer level programming mode. If the code is unknown, enter "0852*" within 60 seconds of powering-up the control. The keypad indicators will flash, indicating entry into the programming mode.
2. Enter Function 333 and press the Find (#) key.
3. Enter a value of 1 and press the Store (*) key. The first indicator (Zone 1) should now be lighted.
4. Press the Store (*) key twice to exit the programming mode. There will be a 5 – 10 second delay while the control restores the factory default values. During this time, the keypad will not respond to other commands. After approximately 5–10 seconds, the factory default values will be restored and the control will return to normal operation.

Program Function Map

Func. No.	Function	Valid Range	Factory Default	New Value
001	MASTER User Authorization Code	4 digits each 0-9	1245	
002	User Authorization Code 2	0-9	FFFF	
003	User Authorization Code 3	0-9	FFFF	
004	User Authorization Code 4	0-9	FFFF	
005	User Authorization Code 5	0-9	FFFF	
006	User Authorization Code 6	0-9	FFFF	
007	User Authorization Code 7	0-9	FFFF	
008	User Authorization Code 8	0-9	FFFF	
009	Code 8 Temporary User Count	0-254 255=Permanent	255	
010	Time Until Next Test (Hours)	0-24	No Default	
011	Clear Alarm Memory	NO VALUE REQUIRED		
012	Delete User Codes	1-8	No Default	
013	Entrance Delay 1 Time (Seconds)	1-255	30	
014	Entrance Delay 2 Time (Seconds)	1-255	46	
015	Exit Time (Seconds)	1-255	60	
016	Access On Time (Seconds)	0-255, 0=Latch	5	
017	Delay Before Burglar Alarm (Seconds)	0-255	0	
018	Burglar Cutoff Time (Minutes)	1-254 255=Never Cutoff	10	
019	Aux. A (Fire) Cutoff Time (Minutes)	1-254 255=Never Cutoff	255	
020	Aux. B (Holdup) Cutoff Time (Minutes)	1-254 255=Never Cutoff	10	
021	Aux. C Cutoff Time (Minutes)	1-254 255=Never Cutoff	10	
022	Time between Comm. Test 0-7 day	0-7 0=12 Hours 1-7=Days	1	
023	Go Off Hook & Initiate/Download	NO VALUE REQUIRED		
024	Code 1 Configuration Digit	0-15	3	
025	Code 2 Configuration Digit	0-15	3	
026	Code 3 Configuration Digit	0-15	3	
027	Code 4 Configuration Digit	0-15	3	
028	Code 5 Configuration Digit	0-15	3	
029	Code 6 Configuration Digit	0-15	3	
030	Code 7 Configuration Digit	0-15	3	
031	Code 8 Configuration Digit	0-15	3	

CONFIGURATION DIGITS	
Digit	Description
1	Arm and disarm the control.
2	Activate access output. †
3	Arm/disarm the control. 0 (held for 3 seconds) followed by user code activates access output. †
4	High Security Arm/Disarm. When the control is armed by a High Security code, only a level 4 or level 9 code can disarm.
5	Arm and disarm the control and activate access output simultaneously. †
6	Special Arm/Disarm. Same as digit 1 except if the communicator is programmed for opening/closing reports, no report will transmit when this code is used to arm or disarm the control.
7	Arm/disarm, and activate access output simultaneously. Press 0 and hold for three seconds. Enter valid user code to activate access independently. †
8	NOT USED
9	Arm/disarm, and transmit the duress code simultaneously.

† The Access output can be provided from one of the Programmable Outputs.

Func. No.	Function	Valid Range	Factory Default	New Value
032	Programmable Output 1 Configuration	0-255	15	
033	Programmable Output 2 Configuration	0-255	112	
034	Programmable Output 3 Configuration	0-255	0	
035	Programmable Output 4 Configuration	0-255	48	
036	Pulse Burglar Alarm Output	0=No 1=Yes	0	
037	Pulse Aux. A (Fire) Output	0=No 1=Yes	0	
038	Report Lockout By Zone	0=No 1=Yes	0	

PROGRAMMING OUTPUT CONFIGURATIONS					
Select value for the programmable output configuration. Values not shown are illegal and should not be programmed.					
Value	Provides a +12V Output Upon:	Value	Provides Siren †† Output Upon:	Value	Provides a +12V Output for:
1	Burglar (BA) Alarm	17	Burglar (BA) Alarm	0	Armed Indication
2	Fire (FA) Alarm	18	Fire (FA) Alarm	16	Armed With Bypass Indication
3	BA or FA Alarm	19	BA & FA Alarm	32	System Trouble Indication
4	Holdup (HU) Alarm	20	Holdup (HU) Alarm	48	Alarm Memory Indication
5	BA or HU Alarm	21	BA & HU Alarm	64	Interior OFF Indication
6	FA or HU Alarm	22	FA & HU Alarm	80	Delay OFF Indication
7	BA, FA, or HU Alarm	23	BA, FA, & HU Alarm	96	Pre-Alarm (entry alert) Indication
8	Aux C Alarm	24	Aux C Alarm	112	Switched Power (Smoke Reset)
9	BA or Aux C Alarm	25	BA & Aux C Alarm	128	Ready Indication
10	FA or Aux C Alarm	26	FA & Aux C Alarm	144	Exit Delay Indication
11	BA, FA or Aux C Alarm	27	BA, FA & Aux C Alarm	160	Access (Door Strike) Trigger
12	HU or Aux C Alarm	28	HU & Aux C Alarm	176	Low Battery Indication
13	BA, HU or Aux C Alarm	29	BA, HU & Aux C Alarm	192	Fail To Communicate Indication
14	FA, HU or Aux C Alarm	30	FA, HU & Aux C Alarm	208	Lamp Trigger
15	BA, FA, HU or Aux C Alarm	31	BA, FA, HU & Aux C Alarm	224	Listen-in Trigger
††	Programmable Output 1 (Terminal #3) is the only output which can be configured as a siren output.			240	Special Extended Outputs (Requires Z229c Module)

Func. No.	Function	Valid Range	Factory Default	New Value
039	Zone Superv. Config. (See Worksheet)	0-255	0	
040	Eliminate Burg. Loop E.O.L. Resistor	0=No 1=Yes	0	
041	Zone 1 Definition (See Planning Guide)	0-255	64	
042	Zone 2 Definition	0-255	72	
043	Zone 3 Definition	0-255	81	
044	Zone 4 Definition	0-255	65	
045	Zone 5 Definition	0-255	65	
046	Zone 6 Definition	0-255	65	
047	Zone 7 Definition	0-255	65	
048	Zone 8 Definition	0-255	65	

ZONE SUPERVISORY CONFIGURATION WORKSHEET									Add Values To Get Total For F39.
* Use Checks (✓) To Indicate Selection									
Zone	1	2	3	4	5	6	7	8	
Binary Value	1	2	4	8	16	32	64	128	
Indicate Selection									Total
Enter Binary Value Of Each Selection									

049	Communicator Disable/Delay in Sec.	0-255 0=Disable	0	
050	Tel. #1 Dial Attempts	1-15	8	
051	Tel. #2 Dial Attempts	1-15	8	
052	Tel. On-Hook Time Before Dial	0-255	3	
053	Time Between Dial Attempts	0-15	10	
054	Abort Communicator if Disarmed	0=No 1=Yes	0	
055	Disable Dialer Test On Power-up	0=No 1=Yes	0	
056	Exception Opening/System Restore	0=No 1=Yes	0	
057	Pulse Dial 63/37 Make/Break Ratio	0=No 1=Yes	0	
058	9 Sec. Wait For Dial Tone	0=No 1=Yes	0	
059	Dial Tone Is Required	0=No 1=Yes	0	
060	Telephone #1 Account Code Digit 1	0-15*	0	
061	Telephone #1 Account Code Digit 2	0-15*	8	
062	Telephone #1 Account Code Digit 3	0-15*	8	
063	Telephone #1 Account Code Digit 4	0-15*	8	

* Digit 1 must always be "0" unless 4/2 format is enabled. A "0" signifies no entry. To report the number "0", a "10" must be programmed. TRANSPORT-PC and some receivers translate numbers 10, 11, 12, 13, 14, 15 to hexadecimal characters A, B, C, D, E, F respectively.

Func. No.	Function	Valid Range	Factory Default	New Value
064	Telephone #1 Transmission Format	0-7	2	
065	Telephone #1 Single Round Report	0=No 1=Yes	0	
066	Telephone #1 4/2 Transmission Format	0=No 1=Yes	0	
067	Telephone #1 Standard Extended	0=No 1=Yes	0	
068	Telephone #1 Single Line Extended	0=No 1=Yes	0	
069	Telephone #1 Parity Checksum	0=No 1=Yes	0	
070	Telephone #1 Touchtone (R) Dialing	0=No 1=Yes	0	

COMMUNICATOR TRANSMISSION FORMATS	
Format	Description
0	Autobaud. Format 1 or 2 automatically selected based on handshake tone from receiver.
1	1400 Hz. handshake, 1900 Hz. data, 10 baud. (Ademco, Adcor, FBI, Osborne Hoffman, Radionics, Silent Knight, Varitech, and Vertex, slow format.)
2	2300 Hz. handshake, 1800 Hz. data, 20 baud. (DCI, FBI, Franklin, Osborne Hoffman, SESCOA, Varitech, and Vertex, fast format.)
3	1400 Hz. or 2300 Hz. handshake, 1800 Hz. data, 40 baud. (Radionics superfast no parity.)
4	1400 Hz. handshake, 1900 Hz. data, 15 baud. (Silent Knight fast format.)
5	Radionics BFSK ® (1400 Hz. or 2300 Hz. handshake). (FBI, Radionics, and Varitech.)
6	Modem II ® (Radionics #6500). The primary report code values for all conditions are internally fixed in the Modem II format and cannot be altered. Each report is enabled with a programmed value of 1 or greater, or disabled with a value of 0. The extended code values for zones 1-8 and keypad panic keys A, B, & C are fixed at 1-11 and cannot be altered. You may custom program the User extended codes for openings & closings. For duress, cancel, and abort conditions, the User extended opening codes are used.
7	SESCOA Model 3000, fast format.

Func. No.	Function	Valid Range	Factory Default	New Value
071	Zone 1 Tel # Configuration	0-4	3	
072	Zone 1 Alarm Code	0-15	3	
073	Zone 1 Extended Alarm Code	0-15	1	
074	Zone 2 Tel # Configuration	0-4	3	
075	Zone 2 Alarm Code	0-15	3	
076	Zone 2 Extended Alarm Code	0-15	2	
077	Zone 3 Tel # Configuration	0-4	3	
078	Zone 3 Alarm Code	0-15	3	
079	Zone 3 Extended Alarm	0-15	3	
080	Zone 4 Tel # Configuration	0-4	3	
081	Zone 4 Alarm Code	0-15	3	
082	Zone 4 Extended Alarm Code	0-15	4	
083	Zone 5 Tel # Configuration	0-4	3	
084	Zone 5 Alarm Code	0-15	3	
085	Zone 5 Extended Alarm Code	0-15	5	

D

Func. No.	Function	Valid Range	Factory Default	New Value
086	Zone 6 Tel # Configuration	0-4	3	
087	Zone 6 Alarm Code	0-15	3	
088	Zone 6 Extended Alarm Code	0-15	6	
089	Zone 7 Tel # Configuration	0-4	3	
090	Zone 7 Alarm Code	0-15	3	
091	Zone 7 Extended Alarm Code	0-15	7	
092	Zone 8 Tel # Configuration	0-4	3	
093	Zone 8 Alarm Code	0-15	3	
094	Zone 8 Extended Alarm Code	0-15	8	

TELEPHONE CONFIGURATIONS	
Configuration	Description
0	Do not dial (no report)
1	Dial telephone number 1 only (split reporting)
2	Dial telephone number 2 only (split reporting)
3	Dial telephone number 1 first, if unsuccessful, dial telephone number 2. Repeat sequence until successful (backup reporting)
4	Dial telephone numbers 1 and 2 (dual reporting)

Func. No.	Function	Valid Range	Factory Default	New Value
095	Zone 1 Shunt Code:	0-15	0	
096	Zone 1 Extended Shunt Code:	0-15	1	
097	Zone 2 Shunt Code:	0-15	0	
098	Zone 2 Extended Shunt Code:	0-15	2	
099	Zone 3 Shunt Code:	0-15	0	
100	Zone 3 Extended Shunt Code:	0-15	3	
101	Zone 4 Shunt Code:	0-15	0	
102	Zone 4 Extended Shunt Code:	0-15	4	
103	Zone 5 Shunt Code:	0-15	0	
104	Zone 5 Extended Shunt Code:	0-15	5	
105	Zone 6 Shunt Code:	0-15	0	
106	Zone 6 Extended Shunt Code:	0-15	6	
107	Zone 7 Shunt Code:	0-15	0	
108	Zone 7 Extended Shunt Code:	0-15	7	
109	Zone 8 Shunt Code:	0-15	0	
110	Zone 8 Extended Shunt Code:	0-15	8	

E

Func. No.	Function	Valid Range	Factory Default	New Value
111	Zone 1 Restore Code:	0-15	0	
112	Zone 1 Extended Restore Code:	0-15	1	
113	Zone 2 Restore Code:	0-15	0	
114	Zone 2 Extended Restore Code:	0-15	2	
115	Zone 3 Restore Code:	0-15	0	
116	Zone 3 Extended Restore Code:	0-15	3	
117	Zone 4 Restore Code:	0-15	0	
118	Zone 4 Extended Restore Code:	0-15	4	
119	Zone 5 Restore Code:	0-15	0	
120	Zone 5 Extended Restore Code:	0-15	5	
121	Zone 6 Restore Code:	0-15	0	
122	Zone 6 Extended Restore Code:	0-15	6	
123	Zone 7 Restore Code:	0-15	0	
124	Zone 7 Extended Restore Code:	0-15	7	
125	Zone 8 Restore Code:	0-15	0	
126	Zone 8 Extended Restore Code:	0-15	8	
127	Supervisory Tel. # Configuration:	0-4	3	
128	Zone 1 Supervisory Code:	0-15	0	
129	Zone 1 Extended Supervisory Code:	0-15	1	
130	Zone 2 Supervisory Code:	0-15	0	
131	Zone 2 Extended Supervisory Code:	0-15	2	
132	Zone 3 Supervisory Code:	0-15	0	
133	Zone 3 Extended Supervisory Code:	0-15	3	
134	Zone 4 Supervisory Code:	0-15	0	
135	Zone 4 Extended Supervisory Code:	0-15	4	
136	Zone 5 Supervisory Code:	0-15	0	
137	Zone 5 Extended Supervisory Code:	0-15	5	
138	Zone 6 Supervisory Code:	0-15	0	
139	Zone 6 Extended Supervisory Code:	0-15	6	
140	Zone 7 Supervisory Code:	0-15	0	
141	Zone 7 Extended Supervisory Code:	0-15	7	
142	Zone 8 Supervisory Code:	0-15	0	
143	Zone 8 Extended Supervisory Code:	0-15	8	
144	Keypad Panic A (Fire) Tel. # Config.	0-4	3	

Func. No.	Function	Valid Range	Factory Default	New Value
145	Keypad Panic A (Fire) Alarm Code:	0-15	1	
146	Keypad Panic A (Fire) Ext. Alarm Code:	0-15	1	
147	Keypad Panic A (Fire) Restore Code:	0-15	0	
148	Keypad Panic A (Fire) Ext. Rest. Code:	0-15	0	
149	Keypad Panic B (Police) Tel. # Config.	0-4	3	
150	Keypad Panic B (Police) Alarm Code:	0-15	2	
151	Keypad Panic B (Police) Ext. Alarm Code:	0-15	2	
152	Keypad Panic B (Police) Restore Code:	0-15	0	
153	Keypad Panic B (Police) Ext. Rest. Code:	0-15	0	
154	Keypad Panic C (Auxiliary) Tel. # Config.	0-4	3	
155	Keypad Panic C (Aux.) Alarm Code:	0-15	4	
156	Keypad Panic C (Aux.) Ext. Alarm Code:	0-15	4	
157	Keypad Panic C (Aux.) Restore Code:	0-15	0	
158	Keypad Panic C (Aux.) Ext. Restore Code:	0-15	0	
159	Keypad Panic Duress Tel. # Config.	0-4	3	
160	Keypad Panic Duress Alarm Code:	0-15	0	
161	Keypad Panic Duress Extended Code:	0-15	0	
162	Keypad Panic Duress Restore Code:	0-15	0	
163	Keypad Panic Duress Ext. Restore Code:	0-15	0	
164	Opening/Closing Tel. # Configuration:	0-4	3	
165	User 1 Opening Code:	0-15	0	
166	User 1 Opening Extended Code:	0-15	1	
167	User 2 Opening Code:	0-15	0	
168	User 2 Opening Extended Code:	0-15	2	
169	User 3 Opening Code:	0-15	0	
170	User 3 Opening Extended Code:	0-15	3	
171	User 4 Opening Code:	0-15	0	
172	User 4 Opening Extended Code:	0-15	4	
173	User 5 Opening Code:	0-15	0	
174	User 5 Opening Extended Code:	0-15	5	
175	User 6 Opening Code:	0-15	0	
176	User 6 Opening Extended Code:	0-15	6	
177	User 7 Opening Code:	0-15	0	
178	User 7 Opening Extended Code:	0-15	7	

Func. No.	Function	Valid Range	Factory Default	New Value
179	User 8 Opening Code:	0-15	0	
180	User 8 Opening Extended Code:	0-15	8	
181	Keyswitch Opening Code:	0-15	0	
182	Keyswitch Opening Extended Code:	0-15	9	
183	User 1 Closing Code:	0-15	0	
184	User 1 Closing Extended Code:	0-15	1	
185	User 2 Closing Code:	0-15	0	
186	User 2 Closing Extended Code:	0-15	2	
187	User 3 Closing Code:	0-15	0	
188	User 3 Closing Extended Code:	0-15	3	
189	User 4 Closing Code:	0-15	0	
190	User 4 Closing Extended Code:	0-15	4	
191	User 5 Closing Code:	0-15	0	
192	User 5 Closing Extended Code:	0-15	5	
193	User 6 Closing Code:	0-15	0	
194	User 6 Closing Extended Code:	0-15	6	
195	User 7 Closing Code:	0-15	0	
196	User 7 Closing Extended Code:	0-15	7	
197	User 8 Closing Code:	0-15	0	
198	User 8 Closing Extended Code:	0-15	8	
199	Keyswitch Closing Code:	0-15	0	
200	Keyswitch Closing Extended Code:	0-15	9	
201	Cancel Tel. # Configuration	0-4	3	
202	Cancel Code:	0-15	0	
203	Cancel Extended Code:	0-15	9	
204	Abort Tel. # Configuration:	0-4	3	
205	Abort Code:	0-15	0	
206	Abort Extended Code:	0-15	9	
207	Lo. Battery/Overload Prot Tel. # Config	0-4	3	
208	Lo. Battery/Overload Prot Code:	0-15	0	
209	Lo. Battery/Overload Prot Extended Code:	0-15	0	
210	Lo. Battery/Restore Overload Prot Code:	0-15	0	

Func. No.	Function	Valid Range	Factory Default	New Value
211	Lo. Battery Restore/Overload Prot Extended Code:	0-15	0	
212	AC Fail Tel. # Configuration:	0-4	3	
213	AC Fail Code:	0-15	0	
214	AC Fail Extended Code:	0-15	0	
215	AC Fail Restore Code:	0-15	0	
216	AC Fail Restore Extended Code:	0-15	0	
217	Missing Keypad/Memory Error Tel. # Configuration:	0-4	3	
218	Missing Keypad/Memory Error Code:	0-15	0	
219	Missing Keypad/Mem. Error Ext. Code:	0-15	0	
220	Test Tel. # Configuration:	0-4	3	
221	Automatic Test Code:	0-15	0	
222	Automatic Test Extended Code:	0-15	0	
223	Upload/Download Complete Tel. # Config:	0-4	3	
224	Upload/Download Complete Code:	0-15	0	
225	Upload/Download Complete Ext. Code:	0-15	9	
226	Upload/Download Denied Tel. # Config:	0-4	3	
227	Upload/Download Denied Code:	0-15	0	
228	Upload/Download Denied Ext. Code:	0-15	0	
229-244	Telephone #1 Number to Dial:	0-15**	F's	
245	***Cannot Be Programmed***			
246	Copy Acct. Formats (Tel. #1 to Tel. #2)		NO VALUE REQUIRED	
247	Copy Tel. #1 to Tel. #2		NO VALUE REQUIRED	
248	Telephone #2 Account Code Digit 1:	0-15*	0	
249	Telephone #2 Account Code Digit 2:	0-15*	8	
250	Telephone #2 Account Code Digit 3:	0-15*	8	
251	Telephone #2 Account Code Digit 4:	0-15*	8	
252	Telephone #2 Transmission Format:	0-7	2	
253	Telephone #2 Single Round Report=	0=No 1=Yes	0	

* Digit 1 must always be "0" unless 4/2 format is enabled. A "0" signifies no entry. To report the number "0", a "10" must be programmed. TRANSPORT-PC and some receivers translate numbers 10, 11, 12, 13, 14, 15 to hexadecimal characters A, B, C, D, E, F respectively.

** 0 or 10 = dials number "0", 11 and 12 Touchtone "*" and "#", 13 = three second pause, 14 = wait for 2nd dial tone, 15 = end of dial MUST follow last digit.

Func. No.	Function	Valid Range	Factory Default	New Value
254	Telephone #2 4/2 Transmission Format=	0=No 1=Yes	0	
255	Telephone #2 Standard Extended=	0=No 1=Yes	0	
256	Telephone #2 Single Line Extended=	0=No 1=Yes	0	
257	Telephone #2 Parity Checksum=	0=No 1=Yes	0	
258	Telephone #2 Touchtone (R) Dialing=	0=No 1=Yes	0	
259-274	Telephone #2 Number to Dial:	0-15**	F's	
275	Listen-in On Telephone #1=	0=No 1=Yes	0	
276	Listen-in On Telephone #2=	0=No 1=Yes	0	
277	Listen-in Time/AC Fail Report:	0-15	1	
278	Answer Mach. Bypass 2nd Call Time Limit (10 sec. increments):	0-15	0	
279	Number Rings Until Auto-Answer: (When Armed)	0-15	15	
280-295	Call Back Telephone Number:	0-15**	F's	
296	***Cannot Be Programmed***	NO VALUE REQUIRED		
297	Installer Program Authorization Code:	0-9	96321	
298	Restore User Code	NO VALUE REQUIRED		
299	Two Digit Arm=	0=No 1=Yes	0	
300	Enable Force Arming=	0=No 1=Yes	0	
301	Permanent Force Arming (Shunt) / Continuous Flashing of Bypassed Zones=	0=No 1=Yes	0	
302	Delay Burglar Restore Until Cutoff=	0=No 1=Yes	0	
303	Burglar Reports Until Dialer Lockout:	0-15	0	
304	Burglar Loop Audible Lockout=	0=No 1=Yes	0	
305	Keyswitch Mode Change=	0=No 1=Yes	0	
306	Supervisory Alert Latch=	0=No 1=Yes	0	
307	Automatic Interior Off=	0=No 1=Yes	0	
308	Extend Burg. Loop Stabilization Time	0=No 1=Yes	0	
309	Disable Interior Follower=	0=No 1=Yes	0	
310	Interior On/Off Available If Armed=	0=No 1=Yes	0	
311	Delay Off When Interior Off=	0=No 1=Yes	0	
312	Siren/Bell Test Upon Arming=	0=No 1=Yes	0	
313	Reset Test Timer On Kissoff=	0=No 1=Yes	0	

** 0 or 10 = dials number "0", 11 and 12 Touchtone "*" and "#", 13 = three second pause, 14 =

wait for 2nd dial tone, 15 = end of dial MUST follow last digit.

Func. No.	Function	Valid Range	Factory Default	New Value
314	Interior Default Upon Disarm=	0=No 1=Yes	0	
315	Keypad Panic 3 Sec. Mode=	0=No 1=Yes	1	
316	Disable Keypad Panic Aux. A (Fire)=	0=No 1=Yes	0	
317	Disable Keypad Panic Aux. B (Police)=	0=No 1=Yes	0	
318	Disable Keypad Panic Aux. C=	0=No 1=Yes	0	
319	Disable Keypad Shunting=	0=No 1=Yes	0	
320	Disable Keypad Commands 4 & 5	0=No 1=Yes	0	
321	Disable Keypad Command 6=	0=No 1=Yes	0	
322	Disable Keypad Command 7=	0=No 1=Yes	0	
323	Disable Keypad Command 8=	0=No 1=Yes	0	
324	Silent Keypad on Burglar=	0=No 1=Yes	0	
325	Silent Keypad/No LED Blink On Aux B =	0=No 1=Yes	0	
326	Start Entrance Delay 1 From Keypad=	0=No 1=Yes	0	
327	Fast Loop Response Time: (See Table)	0-15	2	
328	Slow Response Time: (See Table)	0-15	6	
329	Zone Verif. Config. (See Worksheet)	0-255	0	
330	Zone(s) Permitted To Self Verify: (See Worksheet)	0-255	0	
331	Zone Verification Time Window in Sec:	0-255	30	
332	***Cannot Be Programmed***	NO VALUE REQUIRED		
333	Restore Fact. Defaults (New EEPROM)=	0=No 1=Yes	0	
334	***Cannot Be Programmed***	NO VALUE REQUIRED		

LOOP RESPONSE TIME TABLE

0=40ms	2=80ms	4=160ms	6=320ms	8=600ms	10=1 sec.	12=4 sec.	14=8 sec.
1=40ms	3=120ms	5=200ms	7=480ms	9=800ms	11=2 sec.	13=6 sec.	15=10 sec.

ZONE VERIFICATION WORKSHEET

Zone	1	2	3	4	5	6	7	8	Add Values To Get Total For F329. ◆
Binary Value	1	2	4	8	16	32	64	128	
Indicate Selection (✓)									
Enter Binary Value Of Each Selection									

Selection Of Self Verifying (✓)									Add Values To Get Total For F330. ◆
Enter Binary Value Of Each Selection									

Program Function Addendum – Reviewing Event History

The EVENT HISTORY BUFFER is capable of tracking the past 20 events. Each “event” consists of a time stamp (to the nearest hour), the event type, and the applicable zone or user identification. The time stamp is updated by 1 every hour. To determine the number of hours since the event occurred, subtract the event’s time from the current time stamp.

The Event History data can only be accessed by the system installer or remote programming utilizing TRANSPORT-PC.

Func. No.	Function	Func. No.	Function	Func. No.	Function
335	Current Event Time	356	Event 7 Zone/User	377	Event 14 Zone/User
336	Event 1 Time	357	Event 8 Time	378	Event 15 Time
337	Event 1 Type	358	Event 8 Type	379	Event 15 Type
338	Event 1 Zone/User	359	Event 8 Zone/User	380	Event 15 Zone/User
339	Event 2 Time	360	Event 9 Time	381	Event 16 Time
340	Event 2 Type	361	Event 9 Type	382	Event 16 Type
341	Event 2 Zone/User	362	Event 9 Zone/User	383	Event 16 Zone/User
342	Event 3 Time	363	Event 10 Time	384	Event 17 Time
343	Event 3 Type	364	Event 10 Type	385	Event 17 Type
344	Event 3 Zone/User	365	Event 10 Zone/User	386	Event 17 Zone/User
345	Event 4 Time	366	Event 11 Time	387	Event 18 Time
346	Event 4 Type	367	Event 11 Type	388	Event 18 Type
347	Event 4 Zone/User	368	Event 11 Zone/User	389	Event 18 Zone/User
348	Event 5 Time	369	Event 12 Time	390	Event 19 Time
349	Event 5 Type	370	Event 12 Type	391	Event 19 Type
350	Event 5 Zone/User	371	Event 12 Zone/User	392	Event 19 Zone/User
351	Event 6 Time	372	Event 13 Time	393	Event 20 Time
352	Event 6 Type	373	Event 13 Type	394	Event 20 Type
353	Event 6 Zone/User	374	Event 13 Zone/User	395	Event 20 Zone/User
354	Event 7 Time	375	Event 14 Time		
355	Event 7 Type	376	Event 14 Type		

TABLE OF EVENT TYPES

Event	Type	Event	Type
1	Burglar	7	Arm
2	Fire	8	Disarm
3	Holdup	9	Armed With Shunt
4	Auxiliary “C”	10	Control Power
5	Zone Supervisory Trouble	11	10–Day Rollover
6	Trouble Zone/User 1 = AC Power Fail, 2 = Low Battery/Overload Protection, 4 = Supervisory/Trouble Zone 8 = Fail To Communicate, 16 = Memory Error, 32 = Missing Keypad		

3.2 User Level Programming

User level programming provides access to programming functions pertaining to the everyday operation. Programming is performed in the same manner as with installer level programming with the following exceptions:

1. Access to user level programming is by entering the User Authorization Code (User Code 1) rather than the Installer Program Code.
2. Programming is limited to Functions 1–23 only.
3. The Find (#) key will step to the next digit of a multiple digit function (such as a user code) for reading the value of a function but this key will not advance programming to the next function. For example, after entering Function 002 (User Authorization Code 2), the first digit of the code will immediately be displayed. Pressing the Find (#) key will advance to digit 2. This digit is now displayed and the value can be determined. Repeat the process two more times to view digits 3 and 4. If pressed once more, user level programming is automatically exited.
4. Program mode is exited automatically after entering a new value.
5. The eight user authorization codes (Functions 001–008) are accessible only through this level of programming.

Master User Authorization Code

Along with performing normal arm/disarm functions, the Master User Authorization Code (Function 1) is also used to permit access to the user level of programming. This code is 1245 at factory default and can be changed to any other four digit code through user level programming. Do not use the same four digit code sequence as the first four digits of the Installer Program Authorization Code as this will render the installer code inoperative. To enter the user level, press the 9 key and hold for 3 seconds. The keypad will beep 3 tones to signify acceptance. Now enter the Master User or Installer Program Authorization Code. All keypad indicators will blink continuously.

User Level Programming Format

Perform user level programming in the same manner as explained earlier for installer level programming, substituting the Master User Authorization Code for the Installer Program Authorization Code. Functions 1–23 are accessible. Program mode is exited automatically after entering the new function value.

User Level Programming Example

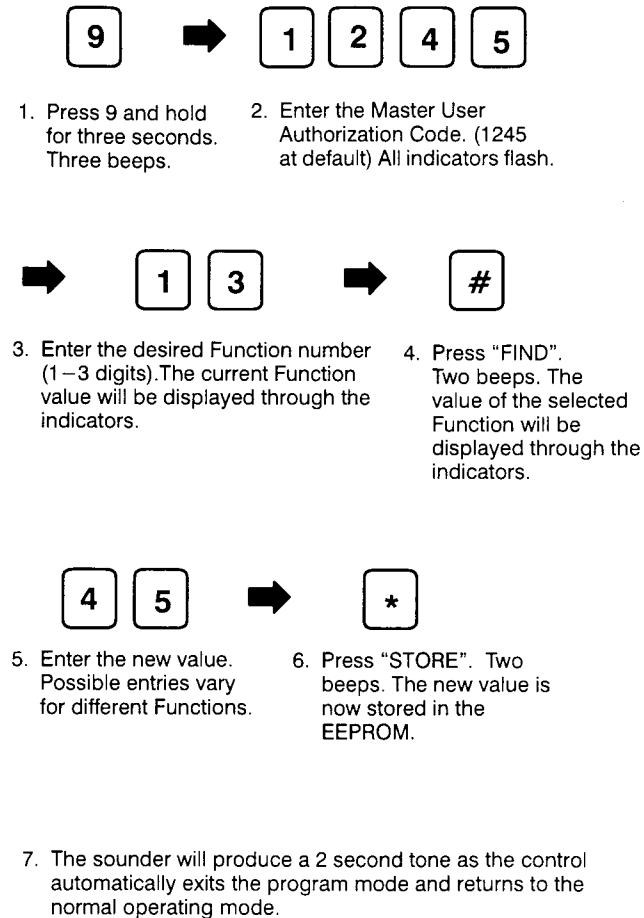

FIGURE 3-4. User Level Programming Example

3.3 Special Programmable Features

Uploading And Downloading (Transport-PC)

A powerful feature of the control is the ability to be reset and/or controlled remotely over a standard telephone line using an IBM PC ® or compatible computer, a Hayes Smartmodem and the software package "Transport PC". Each function of the control can be individually programmed while on line, or the entire memory contents can be uploaded or downloaded with only a few keystrokes. An upload or download usually requires approximately 1 to 2 minutes. The software requires a license agreement. Contact the factory sales department for information.

On Site Manually Assisted Method

Establish a telephone connection between the computer site and the telephone that is connected to the control. Select the Answer mode on the computer. Instruct the individual at the keypad to enter 0-4-3-Reset (*). The control will seize the phone line, and the control will report its status to the computer. When this is complete, the control will await any reprogramming commands. This method is the most secure method of remote programming since it requires assistance at the control site.

Auto Answer and Call Back Method

This method requires two programming functions to be set in order to operate properly. First, Program Function 279-NUMBER RINGS UNTIL AUTO ANSWER (when armed) must have a value of 1 – 15. If the system is not armed, the number of rings will be four (4) greater than the programmed value. A value of 0 will disable auto answer. In addition, Functions 280 through 295 must be programmed with the call back telephone number of the computer. The digit following the last telephone digit must be a value of 15.

In operation, the computer dials the telephone number of the control. Upon detecting the programmed number of rings, the control will answer the call and produce a handshake signal. If the proper computer response is received, the control will hang up and dial the call back telephone number. When the computer answers the dialback, various security procedures take place before any programming information can be exchanged. These include: a security access code, computer operator security code, computer operator levels of access, as well as logging of all computer transactions. If the control does not receive the proper computer response

or if the call back is not answered within a preset time limit, the control will reset to regular operation. The control will make a second attempt if the first attempt fails. This method virtually eliminates computer hackers from gaining access to the control. The zone 8 indicator will illuminate steady whenever the program mode is entered, once this feature is enabled.

Auto Answer With No Call Back

This optional method allows immediate connection of Transport-PC without the requirement of calling back to a specific telephone number or computer. To enable this option, program Auto Answer Function 279 with a value of 1 to 15, and the first digit of the call back number to an "F". When the control answers, Transport-PC immediately supplies the security code and agency code for protection against hackers. The control will ONLY allow a connection to occur if the proper codes are received, and the no-call back option is enabled.

Answer Machine Bypass

Another feature of the system is the built-in answer machine bypass capability for uploading and downloading with "TRANSPORT-PC". Answer Machine bypass is triggered by dialing the control and allowing 1 or 2 rings, then hanging up and re-dialing the control a second time within a programmed time window. Function 278 has a range of 0-15 which selects the maximum time window for the second call in 10 second increments up to a total of 150 seconds. A zero (0) disables the answer bypass. Function 279 sets the number of rings until the control answers without an answer machine, and this function MUST be programmed with a value greater than 0 in order for the answer machine bypass to operate. The following steps explain how to bypass an answering machine.

1. Manually dial the control and allow the phone to ring at least once, but no more than two times, then hang up.
2. Wait 8 seconds and re-dial the control (second call) using the dial command from "TRANSPORT-PC". The control will answer the second call on the first ring, provided that the ring occurs within the pre-programmed maximum time window (Function 278). If the maximum time window is exceeded on the second call, the control will not answer on the first ring and the process will be reset. If an answer machine picks up on the first call, a small amount of time can be required before the machine releases the line. Best results occur when the time window is set for 20 to 30 seconds (a value of 2 or 3).

NOTE

When programmed remotely, zone indicators will scroll in sequence. Transport-PC and the control will automatically disconnect after 10 minutes of no activity from the keyboard. While all methods of remote programming have extensive built-in security features, none are as important as proper operator screening and training to reduce the liabilities involved with this feature.

Anti-Takeover

The "Anti-takeover" feature, activated through TRANSPORT-PC, disables the ability to program telephone numbers.

Silence Exit Delay Beep

The exit beep is silenced automatically when the system is armed with the interior off. This exit beep can be totally disabled by programming in an odd value when programming exit time (Function 15).

Supervisory/Trouble Zone Sub-Option

Supervisory/Trouble is a programmable zone sub-option which allows Burglar, Auxiliary B, Auxiliary C, Communicator report only, and Keyswitch defined zones to react to either an open loop or shorted loop as a trouble instead of an alarm. A choice must be made as to troubles on opens or troubles on shorts. Troubles on loop opens is the factory default if a zone is defined as supervisory/trouble. Upon detection of a supervisory condition, the keypad will beep and display visual information and report the condition to the central station receiver if so programmed. The keypad will continue to display a supervisory condition as long as the condition exists. When the supervisory condition is cleared, the keypad will automatically reset unless the control has been programmed for latching supervisory (see Function 306), in which case it will be necessary to press the Reset (*) key to silence and reset the keypad.

Shunable 24-Hour Auxiliary A, B, C, Communicator, And Keyswitch Zones

Auxiliary A, B, C Zones, Communicator Report Only, and Keyswitch defined zones can be programmed as shunable by adding a value of 32 to their base zone definition. Shunting can be performed using the Bypass (#) key. Shunting of these zones can be used for servicing or in the event of a false alarming detection device.

NOTE

When an Auxiliary A (fire) zone is shunted, the keypad will beep and display a supervisory/trouble condition. If the communicator is enabled and a code is programmed for supervisory/trouble reporting, a report will be transmitted. The keypad can be silenced, but the trouble condition will continue to be displayed until the shunt is removed and the zone secured.

Priority (Non-Shutable) Burglar Zones

For a higher level of security, all burglar zones can be individually programmed as non-shutable. This is accomplished by adding 32 to the zone definition value when defining the zone.

High Security Arm/Disarm Code

One or more of the user authorization codes can be programmed as a high Security Arm/Disarm Code by assigning a configuration digit of 4. Whenever the control is armed by a High Security Code, it can only be disarmed by that code or another High Security designated code. All other user codes are inoperable when the control is armed by a High Security Arm/Disarm Code.

Group Shunting

One or more zones can be shunted simultaneously with a feature called Group Shunting. After observing the faulted zones, press the Bypass (#) followed by an entry of 0. The faulted zones will automatically be shunted, and the keypad will automatically display which zones were shunted.

Digital Communicator

The control has a built-in communicator that can dial two different 16 digit telephone numbers using either rotary or touchtone dialing (Functions 70 and 258). The zones and reportable conditions have programmable report codes and phone number assignments. They may be programmed to report to Phone #1 only, Phone #2 only, Phone #1 primary with Phone #2 as back-up, and both Phone #1 and Phone #2.

Telephone Line Seizure

When the communicator attempts to dial out, it seizes the phone line and goes off-hook for one second. Then, for anti-jam, it goes back on-hook for the *On-Hook Time* (Function 52). Next, it goes off-hook and initiates dial tone detection. Once dial tone is detected, the communicator begins dialing. If dial tone is not detected for the *Dial Tone Wait Time* (Function 58), then the communicator will either dial anyway or count it as a failed attempt and try again depending on if *Dial Tone is Required* (Function 59).

To speed up dialing or to disable the anti-jam function, the *On-Hook Time* may be set to 0.

3.4 Program Function Descriptions

Each programming function is assigned a number that corresponds directly to the numbers listed on the Program Function Map. A description of each function is provided in this section. Select those that are to be programmed, and write the values to be programmed onto the Program Function Map. The pre-programmed (factory default) values are indicated in brackets on the Program Function Map. If a function is to be left at its default value, no programming will be required.

Functions 1-8 can ONLY be accessed through user level programming. Functions 24-333 can ONLY be accessed through installer level programming. Functions 9-23 can be accessed from either user or installer level programming.

1 - Master User Authorization Code

This is a dual purpose code. It can be used for arming/disarming and other day to day operations as determined by the assigned configuration digit, programmed through installer level (Functions 24-31). It also functions as a programming authorization code to provide access to the user level of programming. This code is 1245 at factory default and can be changed at any time through user level programming. This code MUST be four digits in length. Digits can repeat within the code. This function is NOT accessible through installer level programming.

WARNING

DO NOT PROGRAM A USER CODE WITH THE SAME DIGITS AS THE FIRST FOUR DIGITS OF THE INSTALLER PROGRAM AUTHORIZATION CODE. THIS WILL CAUSE THE INSTALLER PROGRAM AUTHORIZATION CODE TO BECOME INOPERABLE.

19 – Auxiliary A (Fire Cut–Off Time)

This is the number of minutes Auxiliary A (fire) alarm output will be active before automatic cutoff. Auxiliary A alarm outputs can be obtained through one of the Programmable Outputs. Valid range is 0 to 255 minutes. A value of 0 or 255 eliminates automatic cut–off. Default is 255 (no cut–off). U.L. allows a 4 minute cutoff.

20 – Auxiliary B (Holdup) Cutoff Time

This is the number of minutes the Auxiliary B (Holdup) alarm output will be active before automatic cutoff. Auxiliary B alarm outputs can be obtained through one of the Programmable Outputs. Valid range is 0 to 255 minutes. A value of 0 or 255 eliminates automatic cut–off. Default is 10 minutes.

21 – Auxiliary C Cutoff Time

This is the number of minutes the Auxiliary C alarm outputs will be active before automatic cutoff. Auxiliary C alarm outputs can be obtained through one of the Programmable Outputs. Valid range is 0 to 255 minutes. A value of 0 or 255 eliminates automatic cut–off. Default is 10 minutes.

22 – Time Between Communicator Tests

This function specifies the time between each automatic communicator test report. This report can be programmed for every 12 hours or from 1 to 7 days. A value of 0 represents 12 hours and values of 1–7 represent days. U.L. requires an automatic test to be performed at least once every 24 hours on commercial installations. Default is 1 day.

23 – Go Off Hook & Initiate Upload/Download (No Value Required)

This function is used to perform a complete EEPROM memory upload to a remote location over ordinary telephone lines. Refer to 3.3 Special Features for details on uploading and downloading. Telephone contact must be made before Function 23 is activated. When this function is activated, the telephone line is seized and the data is uploaded.

24–31 – Configuration Digits For Codes 1–8

Each user authorization code is assigned a security level called a “Configuration Digit” (programming Functions 24 – 31) which defines the operations that the code is authorized to perform. Select the appropriate configuration digit for each code desired and enter the values into the function map. Configuration Digits on page B describes the configuration digits and describes the usage allowed by each.

32–35 – Programmable Alarm Output Configuration

This function determines the type of condition that will activate each of the +12 VDC Programmable Outputs. Select the desired condition from Programming Output Configurations on page B.

36 – Pulsing Burglar Alarm Output

A value of 1 instructs the burglar alarm output to repeatedly pulse, one second on and one second off, whenever a burglar alarm is activated. This applies to outputs programmed for BA. A value of 0 programs the output to be steady. U.L. Note: This function shall be programmed to 1 for Pulsing Burglar Alarm in U.L. listed systems.

37 – Pulsing Auxiliary A (Fire) Alarm Output

A value of 1 instructs the Auxiliary A alarm output to repeatedly pulse, one second on and one second off, whenever an Auxiliary A alarm is activated. This applies to outputs programmed as FA. A value of 0 programs the output to be steady. U.L. Note: This function shall be programmed to 0 for Steady Fire Alarm.

38 – Report Lockout By Zone

A value of 1 will prevent a burglar defined zone from reporting more than one alarm per arm cycle. A 1 is also required for zone restorals from keypad panics.

39 – Zone Supervisory Configuration

Selects supervision on loop open vs. loop short for zones defined as Supervisory. See Zone Planning Guide on page 3–4 . Complete the Zone Supervisory Worksheet on page C, entering the binary values for selected zones. Then add these values together and enter the total into Function 39. If the total from the Zone Supervisory Worksheet is “0”, loop open supervision will be selected for all zones defined as supervisory.

40 – Eliminate Burglar Zone EOLR Supervision

A value of 1 programmed in this location eliminates the need for end-of-line resistors on all burglar defined hardwired zones. The zones will then be unsupervised closed circuit loops. This feature is not allowed on U.L. listed systems.

41–48 – Zone 1–8 Definition

These locations are used to define the 8 hardwired zones. Refer to the Zone Planning Guide and select the desired zone types by entering values of selected zone options and sub-options into the spaces provided. Add the values assigned to each zone and enter the totals for each zone into the respective Functions 41–48.

49 – Communicator Disable And Delay

This function is used to activate or deactivate the communicator. If a value of 0 is entered the communicator will remain inactive. Any value of 1 to 255 will allow the communicator to enable after a delay of the same number in seconds. U.L. requires that the communicator be enabled for either locally or police station connected burglar alarm installations.

50 – Dial Attempts Before Shutdown (Telephone Number 1)

This function sets the number of times that the communicator will attempt to dial the central station receiver using telephone number 1 before automatically shutting down if unsuccessful. Valid range is 1–15. **DO NOT PROGRAM WITH A VALUE OF 0.** If the communicator is unsuccessful, the keypad will begin beeping and the Trouble indicator will present a “Failure to Communicate” 2 condition. Pressing the Reset (*) key will silence the keypad sounder. The Trouble indicator will remain lighted until the communicator successfully establishes contact with the central station receiver and receives a handshake. The Trouble indicator can also be reset by entering the program mode. This failure to communicate warning can be totally disabled for either telephone numbers by programming an odd value (1,3, etc.) for the dial attempts. NOTE: U.L. requires 5 dial attempts minimum, 10 dial attempts maximum. An even value (6, 8, etc.) shall be selected to enable the failure to communicate condition.

51 – Dial Attempts Before Shutdown (Telephone Number 2)

This function sets the number of times the communicator will attempt to dial the central station receiver using telephone number 2 before automatically shutting down if unsuccessful. Valid range is 1–15. See Function 50 for additional information. NOTE: U.L. requires 5 dial attempts minimum, 10 dial attempts maximum. An even value (2, 4, etc.) shall be selected to enable the failure to communicate condition. **DO NOT PROGRAM WITH A VALUE OF 0.**

52 – Communicator On-Hook Time

When the communicator attempts to dial out, it seizes the phone line and goes off-hook for one second. Then, for anti-jam, it goes back on hook for the time specified by this item (valid range is 0–15 seconds). Next, it goes off-hook and initiates dial tone detection. To speed up dialing or to disable the anti-jam function, the *On-Hook Time* may be set to 0.

53 – Time Between Dial Attempts

This is the number of seconds between dial attempts if previous dial attempts were unsuccessful. The telephone line seizure relay releases the line during this time. Valid range is 1–255. U.L. requires no more than 45 seconds for U.L. certified systems.

54 – Abort Communicator Upon Disarming

A value of 1 in this location will allow the communicator transmission to be aborted upon entry of the arm/disarm code.

55 – Disable Dialer Test On Power Up

If a test report code is programmed, a value of 0 allows the communicator to dial the central station with a test report code whenever the system is powered up or reset by the watchdog timer. A value of 1 disables this feature, preventing a dialer test on power up.

56 – Exception Opening/System Restore

A value of 1 causes the communicator to report the opening code **ONLY** when the system has been disarmed (reset) after an alarm. A value of 0 disables Exception Opening/Restore reporting. U.L. Note: This function shall be programmed as 0 in U.L. listed systems.

57 – Pulse Dialing 63/37 Make Break Ratio

When the communicator is transmitting in rotary (pulse) mode, contact closure to the telephone line is made in a 60/40 ratio. A value of 1 in this location instructs the communicator to make contact 63 percent of the time and break contact 37 percent of the time. This 63/37 ratio is necessary in some foreign countries. **[Keep this function programmed to a value of 0 in all U.S. and North American installations.]** U.L. has not evaluated the 63/37 make break ratio format.

58 – 9 Sec Wait For Dial Tone

Programming this function with a value of 0 allows up to a 20 second wait for a dial tone. Using a value of 1 for this function reduces this to a maximum of 9 seconds wait for the dial tone.

59 – Dial Tone Is Required

Programming this function with a value of 0 allows the communicator to dial after the dial tone delay even if no dial tone is detected. Programming the function with a value of 1 prohibits dialing without a dial tone.

60–63 – Account Number (Telephone Number 1)

Functions 60–63 store the 3 or 4 digit account number. Each digit of the account number is stored in a separate function, beginning with function 60=digit 1, 61=digit 2, 62=digit 3, and 64=digit 4. Valid range is 0–15. A zero (0) signifies no digit and must be programmed into Function 60 if only a three digit account number is desired. A 10 must be programmed to represent the number 0. TRANSPORT-PC and some receivers interpret the numbers 10, 11, 12, 13, 14, and 15 as hexadecimal characters A, B, C, D, E, and F respectively.

64 – Transmission Format (Telephone Number 1)

Enter a value of 0–7 to select the communicator transmission format for telephone number 1. Refer to Communicator Transmission Formats on page D. Compatible U.L. listed digital alarm receivers: ADEMCO 685, FBI CP-220, OSBORNE HOFFMAN Quick-Alert, RADIONICS 6000 and 6500. SILENT KNIGHT 9000, LINEAR 3000C and 3000R.

65 – Single Round Reporting (Telephone Number 1)

Some older central station receivers can only receive one report per telephone call. A value of 1 instructs the communicator to hang up after each single report and redial the central station for each additional report. NOTE: Extended reports cannot be used with single round reporting.

66 – 4/2 Extended Transmission Format (Telephone No. 1)

A value of 1 enables 4/2 Transmission format. This is a form of extended reporting whereby the account code, consisting of four digits, is transmitted followed by 2 additional digits. The first of these 2 additional digits represents the report code and the second represents the extended code.

67 – Standard 2 Line Extended Reporting (Telephone No. 1)

A value of 1 enables standard 2 line extended transmission format. In this reporting format, the central station will receive its report on two printed lines. Figure 16 details a burglar report from Zone 4 of customer account number 268. Zone 4 was programmed to report a code 3 “Burglary.”

Example:

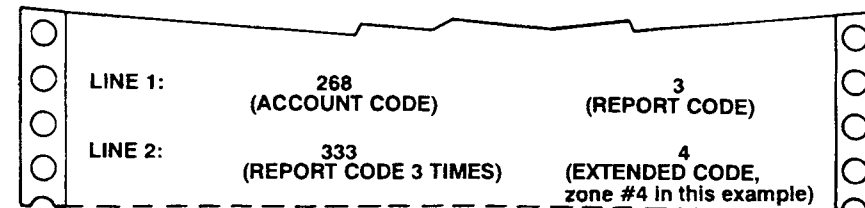

The central station will identify this as: Account 268, report code 3 (burglary) from zone 4.

FIGURE 3-5. Two Line Extended Reporting Example

68 – Single Line Extended (Radionics A+) Reporting (Telephone No. 1)

This format is similar to standard extended format with the exception that report codes from 1 to 10 are not extended, while all codes from 11 (B hexadecimal) through 15 (F hexadecimal) are extended. When sending to Radionics type receivers, the following values will be printed as: 11 = OPENING, 12 = CLOSING, 13 = CANCEL(ABORT), 14 = RESTORAL, and 15 =TROUBLE.

- When programming for Radionics Superfast (3) format, use either extended standard or single line extended (Radionics A+) functions but NEVER BOTH.
- When programming for Radionics BFSK (5) format, one CANNOT select extended standard, single line extended (Radionics A+) or parity checksum (Radionics). The value of these functions must be programmed as 0.

69 – Parity Checksum (Radionics) (Telephone Number 1)

This function commands the communicator to transmit only one line of data containing the account and report code followed by a parity checksum digit for verification rather than sending each line of data twice. The system calculates the parity digit automatically by summing the total of the account and report codes. This feature is most commonly used when transmitting to Radionics receivers and transmission speed is generally faster and telephone connect time is reduced. A value of 1 enables this feature.

70 – Touchtone Dialing (Telephone Number 1)

A value of 1 enables the communicator to dial using touchtone. A value of 0 enables rotary (pulse) dialing.

71–94 – Zone Alarm Reporting Codes And Telephone # Configuration

Functions 71–94 are reporting codes and telephone number configuration for hardwire zones 1–8. In reporting, 1st digit is event, 2nd digit is the identified zone (should be set to 0 if extended reporting not used).

95–110 – Zone Shunt Reporting Codes

These are codes reported when corresponding zone is shunted and the system is armed. In reporting codes, telephone configuration is same as 71–94.

111–126 – Zone Restore Report Code

These are codes reported when the zone is restored following a violation. In reporting codes, telephone configuration is same as 71–94.

127–143 – Zone Supervisory Reporting Code

These are codes reported when a zone programmed for supervisory is activated.

144–148 – Keypad Panic A Report And Telephone # Configuration

This code is reported when keypad panic zone A is activated. Valid range is 0–15. A value of 0 disables reporting.

149–153 – Keypad Panic B

This code is reported when keypad panic Zone B is activated. Valid range is 0–15. A value of 0 disables reporting.

151–158 – Keypad Panic C (Telephone Number 2)

This code is reported when keypad panic zone C is activated. Valid range is 0–15. A value of 0 disables reporting.

159–163 – Duress Reporting Codes (Telephone Number 2)

This code is reported when a duress arm/disarm code is entered at the keypad. Valid range is 0–15. A value of 0 disables reporting.

164–180 – User Opening Report Code

This code is reported when the corresponding user disarms the control.

181–182 – Keyswitch Opening Codes

This code is reported when a keyswitch defined zone is used to disarm the control.

183–198 – User Closing Code

This code is reported when the corresponding user arms the control.

199–200 – Keyswitch Closing Codes

These codes are reported when a keyswitch defined zone is used to arm the control.

201–203 – Cancel Code

This code is reported when the system is disarmed immediately after an alarm has been transmitted.

204–206 – Abort Code

This code is reported when system is disarmed prior to transmission of an alarm.

207–211 – Low Battery/ Overload Protection Reporting Codes

These codes are reported to indicate a low battery/overload protection condition.

212–216 – AC Fail Reporting Code

This is the code reported when AC power is interrupted for more than 5 minutes.

217–219 – Missing Keypad/Memory Error Reporting Codes

These are the codes reported when a missing keypad or EEPROM memory error is detected.

220–222 – Automatic Test Codes

These are the codes reported when the communicator performs a test. Time between tests is set in Function 22.

223–225 – Upload/Download Completed Reporting Codes

This reporting code is sent to the central station immediately after an upload/download session is completed.

226–228 – Upload/Download Denied Reporting Codes

This reporting code is sent to the central station immediately after an upload/download session is denied.

229–244 – Telephone Number 1

Enter the number to be dialed for telephone number in Functions 229 through 244. Valid range is 0–15. A value of 0 or 10 represents dialing digit 0. A value of 11 represents Reset (*) and 12 represents Bypass (#) when using Touchtone dialing. A value of 13 instructs the communicator to pause for three seconds before dialing the next digit. A value of 14 instructs the communicator to wait 10 seconds for a second dial tone. A value of 15 must be programmed in the location following the last dialing digit to signify end of dialing.

245 – Reserved For Future Use**246 – Copy Telephone Number 1 Account And Formats To Telephone Number 2**

Entry into this location will command the system to copy all of the values in Functions 60–69 and 71–94 and duplicate them into Functions 248–257. No values can be programmed into this location.

247 – Copy Telephone Number 1 To Telephone Number 2

Entry into this location will command the system to copy all of the values in Functions 229–244 and enter them into Functions 259–274. No values can be programmed into this location.

248–251 – Account Number (Telephone Number 2)

Functions 248–251 store the 3 or 4 digit account code. Valid range is 0–15. Please refer to Functions 60–63 for additional important information.

252 – Transmission Format (Telephone Number 2)

Program this value in the same manner as Function 64.

253 – Single Round Reporting (Telephone Number 2)

Program this value in the same manner as Function 65.

254 – 4/2 Transmission Format (Telephone Number 2)

Program this value in the same manner as Function 66.

255 – Standard 2 Line Extended Reporting (Telephone Number 2)

Program this value in the same manner as Function 67.

256 – Single Line Extended (Radionics A+) Reporting (Telephone Number 2)

Program this value in the same manner as Function 68.

257– Parity Checksum (Radionics) (Telephone Number 2)

Program this value in the same manner as Function 69.

258 – Touchtone Dialing (Telephone Number 2)

A value of 1 enables the communicator to dial using Touchtone. A value of 0 enables rotary (pulse) dialing.

259–274 – Telephone Number 2

Program the number to be dialed for telephone number 2 in the same manner as programmed in Functions 248–258.

275 – Audio Listen-in Capability (Telephone Number 1)

To enable audio listen-in capability for telephone number 1 for the time programmed in Function 277, program this function to 1. Consult the technical services department for hook-up assistance. Do **not** enable this function when using a TWV1241 Two-Way Voice module (refer to the TWV1200 manual for hook-up and programming instructions). This function must be disabled on U.L. listed systems.

276 – Audio Listen-in Capability (Telephone Number 2)

To enable audio listen-in capability for telephone number 2 for the time programmed in Function 277, program this function to 1. (See Function 275).

277 – Listen-In Activation Time/AC Fail Report

This function controls the time (range 0–15 minutes) that the communicator stays on-line with the central station for listen-in after receiving a kissoff. This only applies if function 275 or 276 is enabled.

This function also controls how an AC failure is reported. If the value programmed is odd, then an AC failure is reported piggy-back with the next event that is reported after the AC failure is detected. If the value programmed is even, then an AC failure is reported five minutes after it is detected.

278 – Answer Machine Bypass 2nd Call Time Limit

For details, refer to page 3–10.

279 – Number Of Rings Until Auto Answer When Armed

This function selects the number of rings which the control will automatically pick up and answer the telephone line when armed. This function must be programmed in order for the auto answer call back method of remote programming to operate (See “Remote Programming.”). Valid range is 0–15. A value of 0 will disable the auto answer call back method. When the control is disarmed, the actual number of rings will be four more than the programmed value. This allows the user to confirm if the control is armed.

280–295 – Call Back Telephone No. (Remote Programming)

Enter the call back telephone number of the remote programming computer that the control is to dial when remote programming is enabled. Program the number to be dialed in the same manner as programmed in Functions 229–244. Valid range is 0–15. A value of 15 must be programmed in the location following the last dialing digit. The automatic call back method of remote programming can be disabled by programming the first digit as 15. U.L. Note: This function shall be disabled by programming a 15 in U.L. listed systems.

296 – Reserved For Future Use.**297 – Installer Program Authorization Code**

The installer program authorization code is used to gain entry into the installer level programming mode. This code **MUST** be 5 digits in length. The code at default is 96321.

298 – Restore User Code 1 Default Value

Entering this location will restore the Master User Authorization Code to its default value (1245). No values can be entered in this location. Because the Master User Authorization Code is required in order to program User Authorization Codes, this function permits the Master Code to be returned to default without having to default the entire memory contents.

299 – Two Digit Arming

A value of 1 in this location will command the system to arm whenever the first two digits of a user authorization code are entered at the keypad. The full code will still be required to disarm. U.L. Note: This function is not to be programmed in U.L. listed systems.

300 – Enable Force Arming

A value of 1 in this location enables force arming. Force arming allows the control to arm even while a zone is faulted. When a user attempts to arm the system with a faulted zone, the keypad will emit a 2 second error tone indicating that the control refused to arm. If the code is re-entered within 8 seconds after the tone quits, the control will “force arm” and the faulted zone(s) will be either temporarily or permanently bypassed, depending on the selection of Function 301. U.L. Note: This function shall be disabled in U.L. listed systems.

301 – Temporary Or Permanent Force Arming

A value of 0 selects temporary force arming which allows a force armed zone to be automatically put back into service when it restores. The zone indicators for bypassed zones will blink until 30 seconds after the system is armed. A value of 1 selects permanent force arming whereby a force armed zone remains bypassed until the system is disarmed. The zone indicators for bypassed zones will blink throughout the armed period. This function shall be disabled in U.L. listed systems.

302 – Delay Burglar Zone Restore Report Until Alarm Cut-off Time Expires

In normal operation, a restoral report, if programmed, is transmitted as soon as the zone restores. Entering a value of 1 in this location prevents the communicator from transmitting a restored zone report until after the alarm cut-off time has expired and the zone has restored. If restoral reports are not programmed, this function can still be used to limit transmissions in the event of a continuously triggering detection device. When this function is programmed, the violated zone cannot report another alarm condition until the alarm cut-off time has expired and the zone has restored.

303 – Burglar Alarm Reports Until Lockout

This function can be programmed to limit the maximum number of successful communicator burglar alarms (from 1 to 15) that can be reported during an armed cycle or timed period. When this value is reached, the communicator will not report another burglar alarm until the system is disarmed and reset or until the 24 hour based automatic test timer expires. This prevents a runaway condition which can be caused by a faulty zone or detector. NOTE: This function affects ONLY burglar defined zone alarms and only locks out after the number of SUCCESSFUL reports. It has no effect on Functions 50 and 51. This function will not work if Function 313 is also selected. This function shall be disabled in U.L. listed systems.

304 – Burglar Loop Audible Lockout

A value of 1 instructs the burglar alarm output to function only once per arm/disarm cycle. The communicator, if enabled will continue to send reports as each zone is violated. This function shall be disabled in U.L. listed systems.

305 – Mechanical Keyswitch Mode Change

A value of 1 in this location allows keyswitch change of interior ON/OFF from a key defined zone.

306 – Supervisory/Day Alert Latch

A value of 1 commands the supervisory/trouble condition to latch on until manually cleared by pressing the Reset (*) key.

307 – Automatic Interior Off

A value of 1 in this location commands the system to automatically switch the interior defined zones off at the expiration of the exit delay if no delay zones are violated during the exit time. This eliminates the user from having to manually turn interior off if staying in the building. The entrance delay will also be switched off at this time, if Function 311 (ENTRANCE DELAY OFF WHEN INTERIOR OFF) is enabled.

308 – Extend Burglar Loop Detector Stabilization Time

Following a total power loss (while the system is armed) the control will ignore all burglar defined zones for 15 seconds to allow detectors time to stabilize. Entering a value of 1 in this location extends this time to 181 seconds. A value of 0 will provide 15 seconds.

309 – Disable Interior Follower

The control automatically ignores all interior defined zones upon entry through a delay defined zone. This allows the motion detectors to be placed between the entry delay door and the keypad. A value of 1 assigned to this function disables the interior follower feature, allowing all interior defined zones to remain instant during the entrance delay period.

310 – Interior On/Off (Key 4) And Delay On/Off (Key 5) Available When Control Is Armed

A value of 1 in this location will allow the interior on/off selection through key 4 and the delay on/off through key 5 to be operable even if the system is armed. A value of 0 will allow changes to interior on/off status only when the system is disarmed. Turning the interior on/off can also toggle the entrance delay on/off, depending upon programming of Function 311.

311 – Entrance Delay Off When Interior Off

A value of 1 in this location instructs the control to disable the entrance delay whenever the interior defined zones are turned off. A value of 0 disables this feature, leaving the entrance delay intact. The delay can be turned off manually by pressing and holding key 5.

312 – Siren/Bell Test Upon Arming

A value of 1 in this location enables a one second test of the burglar alarm output whenever the control is armed. The communicator will not report this alarm.

313 – Reset Test Timer After Successful Report

A value of 1 in this location causes the automatic test timer to reset after receiving a valid “kissoff” signal from the central station receiver. The automatic test will occur 24 hours after the last successful transmission or as set in Function 22.

314 – Interior Default Upon Disarm

A value of 1 instructs the control to turn interior off each time control is disarmed. The entrance delay will also turn off if Function 311 is programmed with a value of 1. U.L. Note: This function shall be programmed to 0 in U.L. listed systems.

315 – Keypad Panic 3 Second (Hold Or Press Twice) Mode

Each keypad panic zone is activated by momentarily pressing its designated key. A value of 1 will instruct the control to ignore momentary key presses and require the key press to be maintained for three seconds (or to be pressed at least twice within three seconds). Default = 1 (3 second mode).

316 – Disable Keypad Panic Zone A (Fire)

A value of 1 disables keypad activated panic zone A. Default is 0 (enabled).

317 – Disable Keypad Panic Zone B (Holdup)

A value of 1 disables keypad activated panic zone B. Default is 0 (enabled).

318 – Disable Keypad Panic Zone C

A value of 1 disables keypad activated panic zone C. Default is 0 (enabled).

319 – Disable Keypad Shunting

A value of 1 disables the ability to manually shunt zones from the keypad.

320 – Disable Keypad Change Of Interior And Delay On/Off (Keys 4 And 5)

A value of 1 disables ability to turn the interior and delay on or off from keypad.

321 – Disable Keypad Change Of Zone Chime On/Off (Key 6)

A value of 1 disables the ability to turn the zone chime on or off from the keypad.

322 – Disable Keypad Switched Power Interrupt (Key 7)

A value of 1 disables ability to reset a low battery condition and interrupt switched power from the keypad.

323 – Disable Keypad Performed Zone Walk Test (Key 8)

A value of 1 disables the ability to perform a zone walk test from the keypad.

324 – Silent Keypad On Burglar Activation

A value of 1 in this location instructs all keypads to be silent during a burglar alarm activation. NOTE: If this function is enabled, a “fail to communicate” condition will not annunciate the keypad sounder. U.L. Note: U.L. listed systems shall have an audible alarm output upon alarm.

325 – Disable Keypad Audible Or Visual Indication On Auxiliary B (Holdup) Activation

A value of 1 instructs keypads not to display visual or audible notification of an Aux. B activation.

326 – Start Entrance Delay 1 Upon Keypad Entries

A value of 1 in this location instructs the control to begin entrance delay 1 when any key is pressed while armed. This feature provides additional protection against keypad tampering for higher levels of security.

327 – Fast Loop Response Time 1

Fast Loop Response Time is the time in milliseconds (ms) that a loop violation must be maintained before a fault will be recognized on any hardwired zone defined as “Fast Response”. A value of 0 or 1 = 40ms, 2 = 80ms, 3 = 120ms, 4 = 160ms, 5 = 200ms, 6 = 320ms, 7 = 480ms, 8 = 600ms, 9 = 800ms, 10 = 1 sec, 11 = 2 sec, 12 = 4 sec, 13 = 6 sec, 14 = 8 sec and 15 = 10 sec.

Note: 80 milliseconds should be the minimum time programmed. U.L. requires that loop response not exceed one second (a value of 10).

328 – Slow Loop Response Time 2

Slow Loop Response Time is the time in milliseconds (ms) that a loop violation must be maintained before a fault will be recognized on any hardwired zone defined as “Slow Response”. Program in the same manner as Function 327.

329 – Zone Verification

Alarm Verification requires two or more selected Burglar zones to be violated within a programmable time window before an alarm can occur. This shall not be enabled in U.L. Listed systems. Complete the Zone Verification Worksheet on page K, entering the binary value of each selected zone. Add the binary values and enter the total into Function 329. If the total is “0”, zone verification is disabled.

WARNING

**SECURITY IS COMPROMISED IN ANY ZONE
PROGRAMMED WITH THIS FEATURE.**

330 – Zone(s) Permitted To Self Verify

Any Burglar zone(s) selected for Zone Verification (F329) may be further defined to allow “Self Verification”, allowing an alarm to occur if the zone is violated twice within the programmed time window. The bottom half of the Zone Verification Worksheet on page K is used for this purpose.

331 – Zone Verification Time Window In Seconds

Function 331 sets the time (1–255 seconds) between zone violations before an alarm sounds. This feature must agree with Functions 329 and 330.

332 – Reserved For Future Use

333 – Restore Factory Defaults (New EEPROM Values)

Factory default EEPROM values are restored by entering a 1 in this location, then exiting program mode. After exiting, the control restores all factory defaults after approximately 5 seconds. Function 298 allows the Master User Authorization Code to be defaulted by itself without having to default the entire control.

NOTE: This function replaces all installer/user level programming values, returning the control to factory default values, disabling all central station communication. If the Anti-takeover option has been programmed by TRANSPORT-PC, it will not be possible to default the telephone numbers and account codes.

Z950 Specifications

4

4.1 Technical Specifications

- Max. of 8 two-wire zones each supervised with a 2,200 ohm end-of-line resistor. Actual number of zones varies depending upon model number.
- 3 keypad activated zones.
- Nominal current drain for control board only: 42 mA.
- Watchdog microprocessor monitoring circuit.
- Superior 4 stage lightning/transient protection.
- 4 programmable current outputs.
- Automatic system shutdown if voltage falls below 7.5 volts.
- Operating temperature range inside the enclosure: 32° F to 120° F (0° C to 49° C).
- Operating voltage range: 10.0 – 12.2 VDC residential.
- Regulated 13.8 VDC output. (See Table 4–1 for U. L. and C.S.F.M. continuous current limits.)
- Reverse polarity protection on battery inputs.
- Float charging circuit: 13.8 VDC.
- Overload protection for Programmable Alarm outputs 1 and 2 at 1.6 amps. Overload protection for Keypad/Aux. 1 output at 900 mA.
- 900 mA continuous regulated.

Recommended Battery:

- Rechargeable 12 volt 4 amp-hour or 12 volt 6 amp-hour sealed lead acid.

Transformer:

- U.L. listed class II plug-in, 16.5 VAC, 35 VA secondary, 120 volt 60 Hz primary.

Power Supply:

- Low voltage detection monitoring @ 11.2 volts threshold.
- Less than 200 millivolts AC ripple.

Enclosure:

- 20 gauge metal cabinet with knockout for optional cam lock. Dimensions: 9” W x 10” H x 2.875” D (228.6mm x 254mm x 73.02 mm).

Keypads:

- Color coded 4 wire hookup.
- Twelve button keypad with audible and tactile feedback.
- Three emergency panic zone keys.
- Mounts to any standard single or double (Z800RE) gang electrical box.
- Indicators provide total system and zone status.
- Built-in piezo sounder.
- Nominal current drain: 20 mA all indicators off, 60mA all indicators and piezo sounder on.
- Up to 7 per system. (See Table 4-1 for U.L. and C.S.F.M. limits.)
- Size: 5.1" H x 3.5" W x 0.9" D (130 mm x 89 mm x 23 mm), Z800RE 4.6" H x 6.8" W x 0.9" D (116 mm x 173 mm x 23mm)
- Color: Bone white with gray labeling.

4.2 Features

- Ready to install with a factory basic program.
- Programmable from multiple keypad configurations.
- Upload/Download programming and control from a remote location using an IBM PC ® or compatible, a Hayes ® modem, and TRANSPORT-PC software.

Digital Communicator:

- Touchtone* or Rotary (pulse) dialing. Rotary speed: 10 pps, (selectable 60% break, 40% make or 66% break, 33% make).
- Ringer equivalence: 0.0B
- Transmission formats include: Slow (10 or 15 baud), fast (20 or 40 baud), Radionics superfast (30 baud), BFSK ®, and Modem II ®.
- Reports to most major central station receivers.
- Primary and secondary phone numbers up to 16 digits.
- Dual reporting capability.

Listings And Approvals:

Household Burglary – U.L. 1023.
Household Fire – U.L. 985.
Household Burglary/Fire –
U.L. 985/1023
CSFM 7167-0695:119

- 8 user authorization codes.
- Programmable communicator lockout of burglar defined zones to limit runaway reporting.
- EEPROM memory retains arm/disarm status, alarm memory and programming after total power loss.

- Self-diagnostics with memory error detection and reporting.
- 8 hardwire zones programmable as burglar, 24 hr. Auxiliary "A" (fire *ff*), Auxiliary "B" (holdup), and Auxiliary "C", and communicator report only.
- 3 keypad activated panic zones.
- A single zone can be programmed for keyswitch arm/disarm.
- Burglar zones can be defined as instant or delay (2 delay timers), interior or perimeter, silent instant, priority (non-shuntable), slow or fast loop response.
- All hardwire zones can be programmed for supervisory/trouble condition latching or momentary.
- Individual or group zone shunt (bypass) from keypad.
- Zone force arm with full shunt, or restore when zone restores.
- 24 hour zones can be programmed as shuntable.
- Programmable Timers: Entry Delay 1 and 2, Exit Delay, Access, Alarm Cut-off, and Delay before audible burglar alarm output.
- Programmable loop response of 40 msec. to 10 seconds.
- Eight (8) second invalid or inactive control station timeout and 3 minute programming timeout.
- Continuous monitoring of overload protection devices.
- Optional siren/bell test upon arming.
- Optional timed or latched access (door strike) output.
- Missing keypad detection with communicator report.
- Digital Communicator Reporting Capabilities:
 - 3 or 4 digit account codes.
 - 1 or 2 digit alarm codes.
 - Report by zone.
 - Single or 2 line extended.
 - Two separate Account Codes.
 - Hexadecimal reporting.
 - Dual, Split, and Backup Reporting.
 - Opening or Closings by User Code.
 - Shunted zone(s) reported upon arming.
 - Exception openings by User Code.
 - Individual zone and or system restore.
 - Cancel/Abort report by User code.
 - Supervisory/trouble by zone.
 - Low battery and battery restoral.
 - AC failure and AC restoral.
 - Automatic test every 12 hours or 1 to 7 days.
 - Delay before dial.
 - Dial attempts for telephone number one and two.
 - Optional fail-to-communicate announcement.

4.3 Optional Accessories

- **TRANSPORT-PC:**
Upload/Download software package.
- **Z232 Relay/Ground Start Module ††:** For use with ground start phone lines.
- **MPI-267 Power Disconnect Module:** Automatically disconnects battery to prevent deep discharge if battery voltage drops below 7.5 volts, plus provides ON/OFF power switch.

Table 4-1. Configurations And Current Drain Provisions

Application	Listing	Maximum Current Drain (milliamps) With 4AH Battery	Minimum Standby Time In Hours	Control Stations	E.S.L. Smoke Detector Model 449AT. ESL Model 204-12/24V Power Supervision Unit	Auxiliary Equipment Required
Non U.L. Listed		900	3	7	N/A	
Burglary/Fire	CSFM	300*	24	3	Required	Wheelock 34T-12 Horn
Household Burglary	U.L. 1023	750	4	6	N/A	Amseco MSB-10G Bell
Household Fire (ff)	U.L. 985	750	4	6	Required	Wheelock 34T-12 Horn
Household Burglary/Fire (ff) Combination	U.L. 1023/985	750	4	6	Required	Amseco MSB-10G Bell and Wheelock 34T-12 Horn

Maximum combined continuous current drain (standby) refers to terminals 3, 4, 6, and Connector J2. Under Alarm conditions, the combined output current drain should not exceed 1.5 A.

* With two 4AH batteries

†† Not A U.L. Listed Device

U.L. And N.F.P.A. Requirements

5

5.1 Underwriters Laboratories (U.L.) Listing

- U.L. 1023 Household Burglary
- U.L. 985 Household Fire (ff)
- U.L. 1023/985 Household Burglary/Fire (ff) Combination.
- California State Fire Marshal 7167-0695:119

5.2 National Fire Protection Association (N.F.P.A.) Rules

The National Fire Protection Association (NFPA) has established rules to follow pertaining to fire prevention and the installation of fire detection equipment.

Smoke Detector Location

Smoke detectors should be installed in accordance with the NFPA standard 72. FIGURE 5-1, page 5-2 illustrates detector placement.

The following is from NFPA 72: Smoke detectors shall be installed outside of each separate sleeping area in the immediate vicinity of the bedrooms and on each additional story of the family living unit including basement and excluding crawl spaces and unfinished attics. In new construction, a smoke detector also should be installed in each sleeping room. For family living units with one or more split levels, (i.e., adjacent levels with less than one full story separation between levels), a smoke detector required by the above shall suffice for an adjacent lower level, including basements.

Exception: When there is an intervening door between one level and the adjacent lower level, a smoke detector shall be installed on the lower level.

Ceiling mounted smoke alarms should be located in the center of the room or hall, not less than 4 inches from any wall. When the detector is mounted on a wall, the top of the detector should be 4 to 12 inches from the ceiling.

Do not install smoke alarms where normal ambient temperatures are above 100° F (38.7° C) or below 40° F (4° C).

Also, do not locate smoke detectors in front of air conditioners, heating registers, or other locations where normal air circulation will keep smoke from entering the detector.

Heat from a fire rises to the ceiling, spreads out across the ceiling surface and begins to bank down from the ceiling. The corner where the ceiling and wall meet is an air space into which heat has difficulty in penetrating. In most fires this dead air space measures about 4 inches (0.1 m) along the ceiling from the corner and 4 inches (0.1 m) down the wall as shown in FIGURE 5-1. Heat or smoke detectors should not be placed in this dead air space.

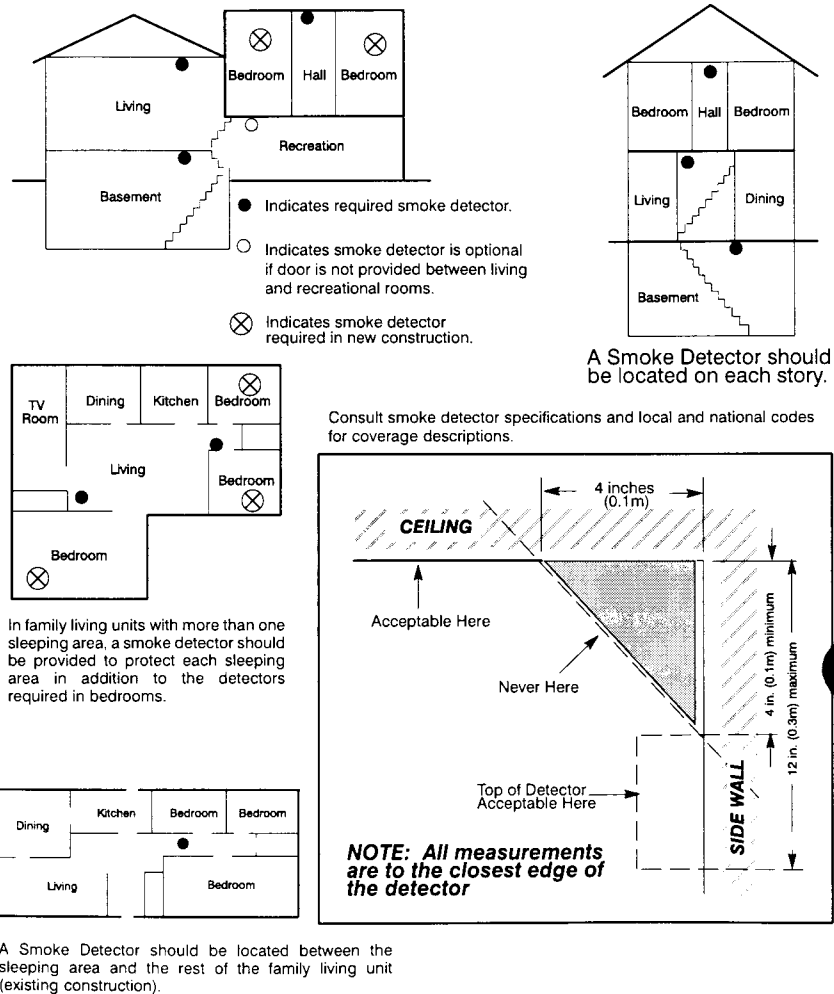

FIGURE 5-1. Smoke Detector Placement

Index

A

Accessories, Optional, 4-4

B

Battery, 1-8

Burglar, Installation Layout, 1-2

D

Diagnostics, 2-7

F

Factory Default, 3-6

Features, 4-2

Keypad, 2-9, 2-10

Programmable, 3-9, 3-10,
3-11, 3-12, 3-13

Fire, Installation Layout, 1-2

I

Installer Level Programming, 3-1

K

Keypad, 2-3

Bypass (#) Key, 3-2

Diagnostics, 2-7

Features, 2-9, 2-10

Find And Store Keys, 3-2

Indicators, 2-6

Operating, 2-3, 2-4, 2-5

Reset (*) Key, 3-2

Wiring, 1-11, 1-13

L

Layout, Installation, 1-2

Listings And Approvals, 4-2

M

Mounting And Wiring, 1-4

N

National Fire Protection Association
(N.F.P.A.), 5-1

O

Outputs, 12 VDC, 1-14

Overload Protection, 1-13

P

Parts, 1-3

Power Loss, 2-2

Power Up, 2-1

Program Function Description,
3-13 - 3-34

Programming, 3-1

Factory Default, 3-6

Installer Level Programming,
3-1

Program Function Descriptions,
3-13

Program Function Map, 3-3

Special Programmable Features,
3-9

User Level Programming, 3-7

Zone Planning Guide, 3-3