

1.3MPx and 3MPx Intelligent IP Box Cameras

IP Open Standards

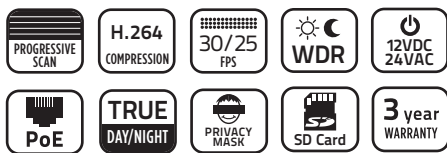

OVERVIEW

The TruVision line of IP Open Standards box cameras bring state-of-the-art, high-definition pictures to the mass video surveillance market. With camera resolutions of 1.3 or 3 megapixel, these IP cameras represent a flexible video surveillance device to meet any need. Equipped with advanced technology and signal processing capability, they effectively capture video under challenging conditions.

TruVision cameras utilize H.264 compression technology with triple-streaming capability, making it easy to manage the camera's bandwidth usage. These cameras adhere to PSIA and ONVIF Profile S open communication standards, and also support a CGI command set for simple integration into any IP system. Video streams can be set for high or low bandwidth, and images can be streamed for live viewing or sent to a designated recording location.

These cameras go above and beyond standard motion detection with enhanced alarm capabilities, including cross lines, intrusion, de-focus and face detection features. Each is user-configurable to best suit the installation environment. A Region of Interest function ensures specific portions of an image are given priority during instances of high network traffic or network degradation.

Location-specific functions include a Hallway View Mode to provide a portrait view of a hallway or corridor, a De-Fog Mode to help resolve images through fog or rain and Electronic Image Stabilization for installations subject to physical vibration or shaking.



STANDARD FEATURES

Video

- 1.3MPx and 3MPx imagers
- H.264 compression with triple-streaming functionality accommodates multiple settings
- Select models feature real-time video streaming up to 1080p resolution for exceptionally detailed image capture
- Designed to PSIA and ONVIF Profile S open standards

Video Enhancement

- True Day/Night functionality
- ROI (Region of Interest), hallway view, mirror, de-fog, electronic image stabilization

Advanced Alarm Intelligence

- Integrated motion detection and privacy masking
- Face detection, audio exception detection, cross line, intrusion detection, de-focus detection, scene change detection
- Alarm inputs and outputs provide easy notification and control of events

Edge Recording

- Edge recording supports up to 64GB micro SD/SDXC card for audio/video playback (card not included)
- Browser-supported mono and bi-directional audio to expand IP stream to include audio

Installation and Environment

- External analog BNC video out connection for easier installation and setup
- Included TruVision Device Manager program provides fast and easy access to newly added system devices

Warranty

- 3-Year warranty

Application

Delivering detailed images in a variety of environments that need it most, IP cameras are specifically designed for applications that require high-quality IP images. These cameras provide ideal surveillance for environments such as retail, banking, airports or gaming where detailed image capture is critical for effectively monitoring people and transactions.

Dimensional Diagrams

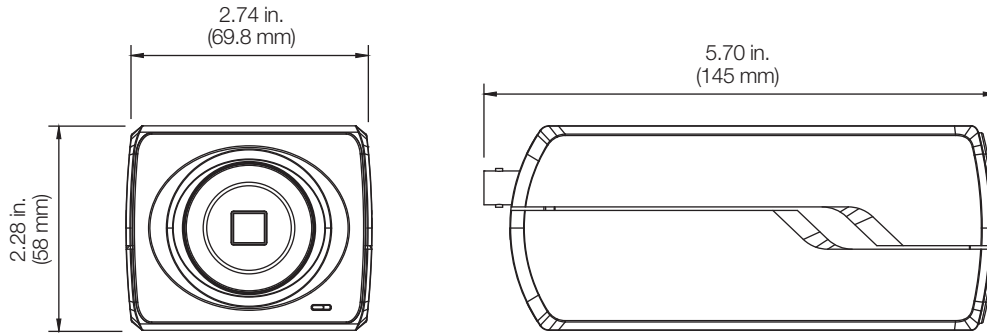

Accessories

TVC-OH/TVC-OH-H

Box Camera and Outdoor IP 66 Clamshell Housing

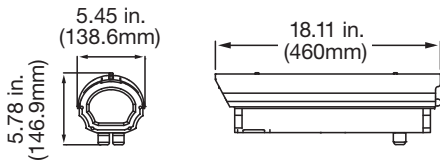

TVC-OH-HW

Box Camera Outdoor IP 66 Clamshell Housings with Heater and Wiper

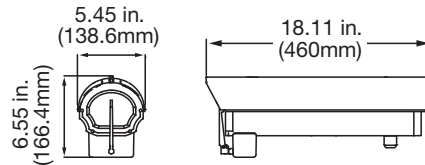

TVC-M-WM Box and Clamshell Housing Wall Mount

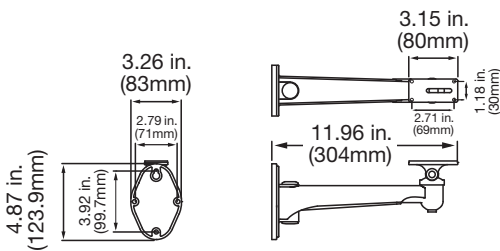

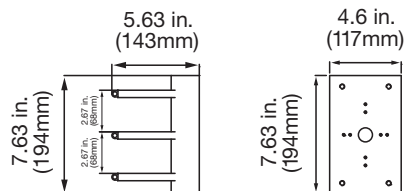

TVD-M-PMA Pole Mount Adaptor

(For use with TVD-M-OWM, TVD-M-WM, TVC-M-WM)



Specifications

PART NO.		TVC-3201 TVC-1201	TVC-3202 TVC-1202
Description			
Camera	Sensor	1/3" Progressive Scan CMOS Sensor	
	Day/Night	IR Cut Filter	
	IP Compression/Standard	H.264 (Baseline profile / Main profile / High profile) / MPEG4 / MJPEG	
	Maximum Resolution (@ fps)	1280 x 960 @ 25fps (50Hz) 1280 x 960 @ 30fps (60Hz)	2048 x 1536 @ 20fps (50Hz) 2048 x 1536 @ 20fps (60Hz)
	Maximum Real-Time Resolution (@ fps)	1280 x 960 @ 25fps (50Hz) 1280 x 960 @ 30fps (60Hz) 1280 x 720 @ 50fps (50Hz, WDR off) 1280 x 720 @ 60fps (60Hz, WDR off)	1920 x 1080 @ 25fps (50Hz) 1920 x 1080 @ 30fps (60Hz)
	Multiple Streaming	Triple Streams	
	Video Bit Rate	128 kbps to 16 Mbps, or user-defined	
	WDR	120dB	
	Sensitivity	Color 0.01 lux @ f1.2, AGC ON B/W 0.001 lux @ f1.2, AGC ON	Color 0.1 lux @ f1.2, AGC ON B/W 0.01 lux @ f1.2, AGC ON
	S/N Ratio	50 dB (AGC OFF)	
	Auto Exposure (shutter)	50 Hz: 1/25s ~ 1/100,000s 60 Hz: 1/30s ~ 1/100,000s	
	Composite Output (BNC)	BNC Port - 1.0 Vp-p @75 ohm	
	Lens	C/CS (w/auto iris)	
Auto Focus	One-touch auto back Focus		
Electrical	Voltage Input	12VDC/24VAC, PoE (IEEE 802.3-af)	
	Current	0.75A @12VDC 0.375A @24VAC	0.79A @12VDC 0.4A @24VAC
	Power Consumption	Max. 9W with IR cut filter on @12VDC/24VAC	Max. 9.5W with IR cut filter on @12VDC/24VAC
	I/O Connection	Terminal type, 1/1	
	Others	RS-485, RS-232	
Network	Network Protocols	TCP/IP, UDP, HTTP, DHCP, DNS, DDNS, ezDDNS, DynDNS, RTP, RTSP, PPPoE, SMTP, NTP, SNMP, HTTPS, FTP, UPnP, NAT, MULTICAST, 802.1x, Qos, IPv4, IPv6	
	PoE	IEEE 802.3-af	
	Port	10/100Mbps, Auto-negotiate, Ethernet port (RJ45)	
Local Storage	Media	Micro SD/SDXC	
	Capacity	Up to 64GB	
Audio	Input	1 ch. 3.5 mm audio interface (2.0 - 2.4 Vp-p, 1K ohm), 1 built-in microphone	
	Output	1 ch. 3.5 mm audio interface (Line level, 600 Ohm)	
	Audio Bitrate (protocol)	64Kbps (G.711) / 16Kbps (G.722.1) / 16Kbps (G.726) / 32-128Kbps (MP2L2)	
Camera Alarms	Basic	Motion Detection, Tamper Proof, Privacy Mask	
	Advanced	Face Detection, Audio Exception Detection, Cross Line, Intrusion Detection, De-focus Detection, Scene Change Detection	
Standard		ONVIF Profile S, PSIA, CGI	
Display	Display mode	ROI (Region of Interest), Hallway View, Mirror, De-fog, Electronic Image Stabilization	
	OSD	Text overlay and picture overlay	
Mechanical/ Environment	Dimensions	2.68 x 2.56 x 5.70 in. (69.8 x 58 x 145mm)	
	Weight	1.83 lbs. (830g)	
	Storage Temperature	-4~158°F (-20~70°C)	
	Operating Temperature	-22~140°F (-30~60 °C)	
	Environmental Rating	Indoor	
Vandal Rating	N/A		
Regulation	Compliance	FCC, CE, UL, C-Tick, REACH, RoHS, WEEE	

1.3MPx and 3MPx Intelligent IP Box Cameras

IP Open Standards

North America
T 855-286-8889

Latin America
T 561-998-6114

Ordering Information

NTSC

TVC-3201	TruVision® IP Box Camera, 1.3MPx, WDR, True D/N, Auto Back Focus, Audio, Alarm, SD/SHDC Slot, Intelligence, PoE (802.3-af) / 12VDC/24VAC, NTSC
TVC-3202	TruVision IP Box Camera, 3MPx, WDR, True D/N, Auto Back Focus, Audio, Alarm, SD/SHDC Slot, Intelligence, PoE (802.3-af) / 12VDC/24VAC, NTSC

PAL

TVC-1201	TruVision IP Box Camera, 1.3MPx, WDR, True D/N, Auto Back Focus, Audio, Alarm, SD/SHDC Slot, Intelligence, PoE (802.3-af) / 12VDC/24VAC, PAL
TVC-1202	TruVision IP Box Camera, 3MPx, WDR, True D/N, Auto Back Focus, Audio, Alarm, SD/SHDC Slot, Intelligence, PoE (802.3-af) / 12VDC/24VAC, PAL

Part Number Schema

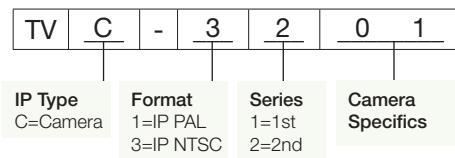

interlogix.com

Specifications subject to change without notice.

© 2015 United Technologies Corporation.

All rights reserved.

Interlogix is part of UTC Building & Industrial Systems, a unit of United Technologies Corporation.

412-3883 2015/01 (80109)