



TruVision Series 5 IP Camera Installation Guide

P/N 1073339-EN • REV B • ISS 13SEP17

Copyright © 2017 United Technologies Corporation, Interlogix is part of UTC Climate, Controls & Security, a unit of United Technologies Corporation. All rights reserved.

Trademarks and patents Trade names used in this document may be trademarks or registered trademarks of the manufacturers or vendors of the respective products.

Manufacturer Interlogix
2955 Red Hill Avenue, Costa Mesa, CA
92626-5923, USA

Authorized EU manufacturing representative:
UTC Fire & Security B.V.
Kelvinstraat 7, 6003 DH Weert, The Netherlands

Certification



FCC compliance **Class A:** This equipment has been tested and found to comply with the limits for a Class A digital device, pursuant to part 15 of the FCC Rules. These limits are designed to provide reasonable protection against harmful interference when the equipment is operated in a commercial environment. This equipment generates, uses, and can radiate radio frequency energy and, if not installed and used in accordance with the instruction manual, may cause harmful interference to radio communications. Operation of this equipment in a residential area is likely to cause harmful interference in which case the user will be required to correct the interference at his own expense.

FCC conditions This device complies with Part 15 of the FCC Rules. Operation is subject to the following two conditions:

(1) This device may not cause harmful interference.

(2) This Device must accept any interference received, including interference that may cause undesired operation.

ACMA compliance **Notice!** This is a Class A product. In a domestic environment this product may cause radio interference in which case the user may be required to take adequate measures.

Canada This Class A digital apparatus complies with CAN ICES-003 (A)/NMB-3 (A).

Cet appareil numérique de la classe A est conforme à la norme CAN ICES-003 (A)/NMB-3 (A).

European Union directives This product and - if applicable - the supplied accessories too are marked with "CE" and comply therefore with the applicable harmonized European standards listed under the EMC Directive 2014/30/EU, the RoHS Directive 2011/65/EU.



2012/19/EU (WEEE directive): Products marked with this symbol cannot be disposed of as unsorted municipal waste in the European Union. For proper recycling, return this product to your local supplier upon the purchase of equivalent new equipment, or dispose of it at designated collection points. For more information see: www.recyclethis.info.



2013/56/EU & 2006/66/EC (battery directive): This product contains a battery that cannot be disposed of as unsorted municipal waste in the European Union. See the product documentation for specific battery information. The battery is marked with this symbol, which may include

lettering to indicate cadmium (Cd), lead (Pb), or mercury (Hg). For proper recycling, return the battery to your supplier or to a designated collection point. For more information see: www.recyclethis.info.

Contact information For contact information, see www.interlogix.com or www.utcssecurityproducts.eu.

Content

Introduction 2

Product overview 2

Installation 3

Installation environment 3

Package contents 4

Cable requirements 10

Camera description 11

Setting up the camera 13

IR illuminators 13

Accessing the SD card 14

Mounting the bullet camera 14

Mounting the turret camera 15

Mounting the dome camera 18

Using the camera with a TruVision recorder or another system 22

Using the camera with TruVision Navigator 22

Specifications 22

TruVision IP bullet cameras 22

TruVision IP turret dome 23

TruVision IP dome cameras 23

Pin definitions 24

Introduction

Product overview

This is the installation guide for TruVision Series 5 IP camera models:

- TVB-5501 (3MPX IP bullet camera)
- TVB-5502 (8MPX IP bullet camera)

- TVT-5501 (3MPX IP turret camera)
- TVT-5502 (8MPX IP turret camera)

- TVD-5501 (3MPX IP dome camera)
- TVD-5502 (8MPX IP dome camera)

Installation

This section provides information on how to install the cameras.

Installation environment

When installing your product, consider these factors:

- **Electrical:** Install electrical wiring carefully. It should be done by qualified service personnel. Always use a proper PoE switch or a 12 VDC UL listed Class 2 or CE certified power supply to power the camera. Do not overload the power cord or adapter.
- **Ventilation:** Ensure that the location planned for the installation of the camera is well ventilated.
- **Temperature:** Do not operate the camera beyond the specified temperature, humidity or power source ratings. The operating temperature of the camera without heater is between -30 to +60°C (-22 to 140°F). Humidity is below 90%. For the outdoor cameras that feature built-in heaters, the operating temperature range is -40 to 60°C (-40 to 140°F)
- **Moisture:** Do not expose the camera to rain or moisture or try to operate it in wet areas. Turn the power off immediately if the camera is wet and ask a qualified service person for servicing. Moisture can damage the camera and also create the danger of electric shock.
- **Servicing:** Do not attempt to service this camera yourself. Any attempt to dismantle or remove the covers from this product will invalidate the warranty and may also result in serious injury. Refer all servicing to qualified service personnel.

- **Cleaning:** Do not touch the sensor modules with fingers. If cleaning is necessary, use a clean cloth with some ethanol and wipe the camera gently. If the camera will not be used for an extended period of time, put on the lens cap to protect the sensors from dirt.

Package contents

Check the package and contents for visible damage. If any components are damaged or missing, do not attempt to use the unit; contact the supplier immediately. If the unit is returned, it must be shipped back in its original packaging.

IP bullet camera

- Camera

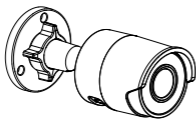

- 12 VDC connector: Two terminal connector with positive and negative indicators.



- Water joint: Provides water resistance to network cable connector.

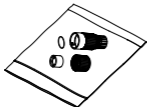

- Drill template

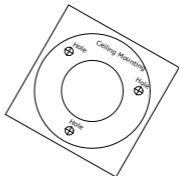

- Screws
Drywall anchor
7.5 × 24.5 mm (3 pcs)



- Screw
M4 × 25 mm (3 pcs)



- CD with Configuration manual and TruVision Device Manager

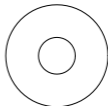

- Installation manual



- Equipment Disposal Sheet

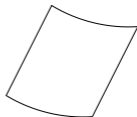

- Battery Disposal Sheet

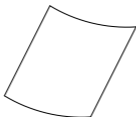

- Torx wrench

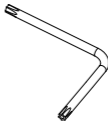

IP turret camera

- Camera

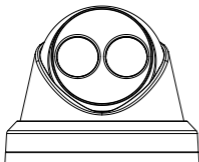

- 12 VDC connector:
Two terminal connector with positive and negative indicators.



- Camera drill template



- Water joint: Provides water resistance to network cable connector.

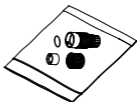

- Screws

Drywall anchor
7.5 × 24.5 mm (4 pcs)



Screw
M4 × 25 mm (4 pcs)



- Adapter plate

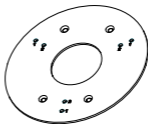

- CD with Configuration manual and TruVision Device Manager

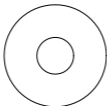

- Screw PM4 × 8 (3pcs)



- Screw PM6-32 × 10 (4 pcs, used to attach the turret camera to a 2 Gang electrical box)



- Screw KM4 × 8 (4 pcs, used to attach the adapter to the brackets)

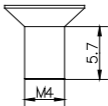

- Torx wrench



- Installation manual

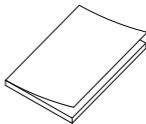

- Installation manual of the turret adapter

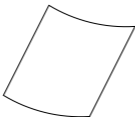

- Equipment Disposal sheet

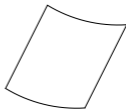

- Battery Disposal Sheet

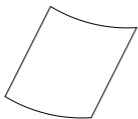

IP dome camera

- Camera

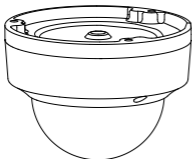

- 12 VDC connector:
Two terminal connector
with positive and
negative indicators.



- Camera drill template



- Screws

Drywall anchor
7.5 × 24.5 mm (3 pcs)



Screw
M4 × 25 mm (3 pcs)



- Torx wrench



- Water joint: Provides water resistance to network cable connector.



- Toggle bolt (3 pcs)

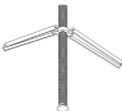

- Gray cloth



- CD with Configuration manual and TruVision Device Manager

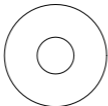

- Installation manual



- Equipment Disposal sheet

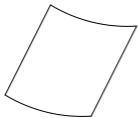

- Battery Disposal Sheet

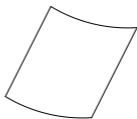

Caution: Use direct plug-in UL listed power supplies marked Class 2/CE certified or LPS (limited power source) of the required output rating as listed on the unit.

Caution: Risk of explosion if the battery is replaced by an incorrect type. Dispose of used batteries according to the instructions.

Cable requirements

For proper operation, adhere to the following cable and power requirements for the cameras. Category 5 cabling or better is recommended. All network cabling must be installed according to applicable codes and regulations. Table 1 lists the requirements for the cables that connect to the camera.

Table 1: Recommended power cable requirements

IP bullet camera:	12 VDC power wires or PoE (802.3af)
IP turret camera:	12 VDC power wires or PoE (802.3af)
IP dome camera:	12 VDC power wires or PoE (802.3af)

Camera description

Figure 1: IP bullet camera

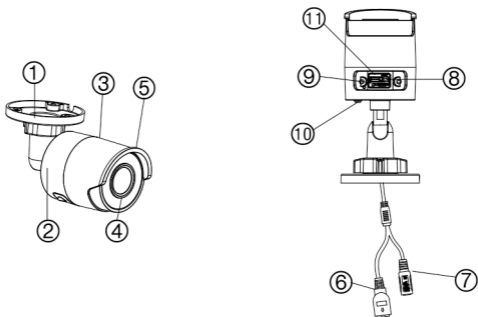

- | | |
|---------------------------|-------------------------------|
| 1. Adjustable bracket | 7. 12 VDC power |
| 2. Back housing | 8. Reset button |
| 3. Front housing | 9. SD card slot |
| 4. Lens | 10. Grounding screw |
| 5. Sunshield | 11. Serial port (factory use) |
| 6. Ethernet RJ45 PoE port | |

Note: To reset the camera to default settings, press and hold the RESET button and power on the camera. After the camera has started up, hold the RESET button for an additional 20 seconds.

Figure 2: IP turret camera

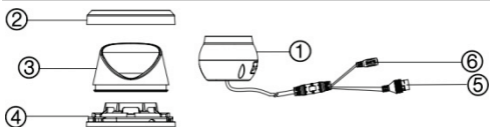

- | | |
|------------------|---------------------------|
| 1. Lens assembly | 4. Base |
| 2. Trim ring | 5. 12 VDC power |
| 3. Housing | 6. Ethernet RJ45 PoE port |

Figure 3: IP dome camera

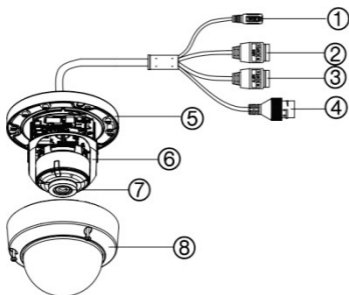

- | | |
|---------------------------|------------------|
| 1. 12 VDC power | 5. Base |
| 2. Audio I/O | 6. Dome liner |
| 3. Alarm I/O | 7. Lens |
| 4. Ethernet RJ45 PoE port | 8. Housing cover |

Setting up the camera

Note: If the light source where the camera is installed experiences rapid, wide-variations in lighting, the camera may not operate as intended.

To quickly put the camera into operation:

1. Prepare the mounting surface.
2. Mount the camera on the mounting surface using the appropriate fasteners. See “Mounting the bullet camera” on page 14.
3. Set up the camera’s network and streaming parameters so that the camera can be controlled over the network. For further information, please refer to the “TruVision Series 5 IP Camera Configuration Manual”.
4. Program the camera as appropriate for its location. For further information, please refer to the “TruVision Series 5 IP Camera Configuration Manual”.

IR illuminators

The camera’s built-in IR illumination provides high-quality video in low-light environments, even when there is no other illumination available.

You can configure the IR illumination using a web browser or a client software, such as TruVision Navigator. If the function is enabled, the IR light is On when the camera enters night (black and white) mode. If disabled, the IR light is always Off.

The visible IR range may vary due to multiple factors such as weather, IR reflection level of objects in frame, lens adjustment, and camera settings. Please refer to the camera datasheet for the standard IR range.

Note: Avoid installing the IR camera closely facing a solid object such as a tree or wall. The reflection will cause over-exposure and loss of visibility of detail in field of view.

Accessing the SD card

Insert a Micro SD card with up to 128GB to use the camera as an additional recording device, or as a backup in case of failure of communication with the network video recorder (see Figure 1 on page 11). The card is not supplied with the camera.

Recorded video and log files can be accessed via the web browser or via TruVision Navigator.

Mounting the bullet camera

Mount the camera on a ceiling or wall.

To mount the bullet camera:

1. Use the supplied template to mark out the mounting area. Drill the screw holes on the ceiling or wall. If you need to route the cables from the camera base, drill a cable hole in the ceiling or wall.
2. Secure the mounting base to the ceiling or wall using the three mounting screws and drywall anchors.

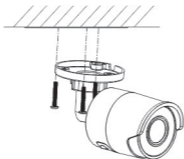

3. Loosen the large nut at the base of the mounting bracket to adjust the camera's viewing angle.

Pan direction: 0 to 360° adjustable

Tilt direction: 0 to 90° adjustable

Rotate direction: 0 to 360° adjustable

4. Adjust the lens to the desired surveillance angle. Tighten the adjustable nuts to complete the installation.

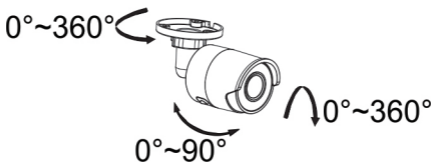

Mounting the turret camera

To mount the turret camera on a surface:

1. Place the drill template (supplied) on the surface where the camera is to be mounted. Drill mounting holes in the surface using the holes labeled number "1" on the drill template.

If you would like to route the cable harness through the mounting surface, cut a cable access hole in the mounting surface, referencing the letter "A" on the drill template. Skip this step if you want to route the cables on the surface.



If installing the turret camera to a wall mount or other accessory, an adapter plate is provided. Install the adapter plate to the accessory with three PM4X8 screws, referencing number "2".

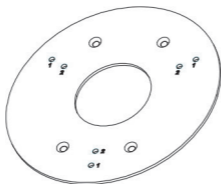

2. Rotate the trim ring counterclockwise to remove it from the camera.
3. Route the cables directly out of the base of the camera.
4. Install the camera on the mounting surface using the supplied hardware.
5. Connect the corresponding power and network cables.
6. Adjust the lens.
 - a) Loosen the locking screw using a Philips screw driver.

- b) Rotate the lens assembly to adjust the pan angle.
Rotate the lens assembly to adjust the tilt angle.
- c) Tighten the locking screw to secure the lens at the desired surveillance angle.

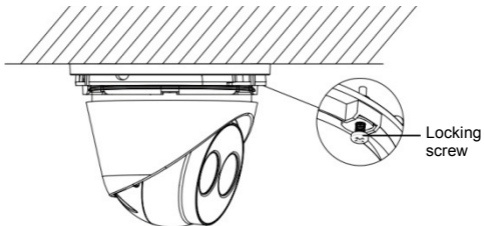

7. Attach the trim ring to the camera and rotate it clockwise to secure it.

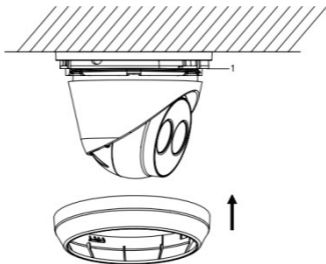

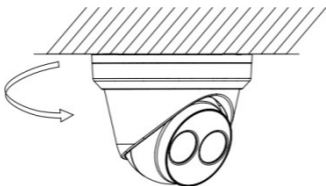

Mounting the dome camera

To mount the dome camera on a ceiling or wall:

1. Place the drill template (supplied) on the surface where the camera is to be mounted. Drill mounting holes in the surface using the holes labeled number '1' on the drill template.

If you would like to route the cable harness through the mounting surface, cut a cable access hole in the mounting surface, referencing the letter "A" on the drill template. Skip this step if you want to route the cables on the surface.



2. Using the supplied Torx wrench, remove the dome bubble assembly.

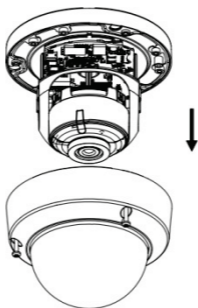
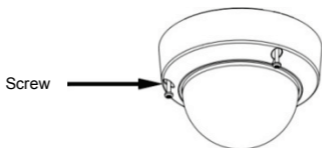

3. Install the dome on the mounting surface using the supplied hardware.

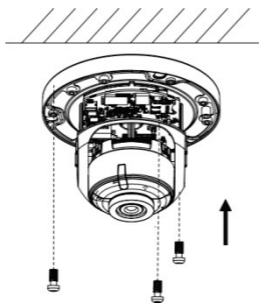

4. Loosen the tilt adjust screws (see image below) and adjust the tilt position of the lens assembly within a range of 75 degrees. Retighten the tilt adjust screws.

Rotate the dome liner to adjust the pan position within a range of 355 degrees. Rotate the lens assembly (0 to 355°) to obtain the desired surveillance angle.

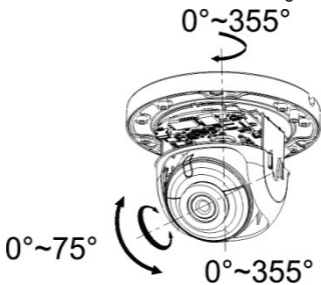

5. (Optional) If using a micro SD card (not included):

To remove the SD card, push the micro SD card forward.
The micro SD card will spring out.

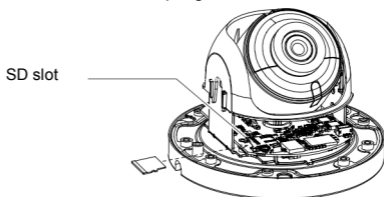

6. Reinstall the dome housing and tighten the Torx screws.

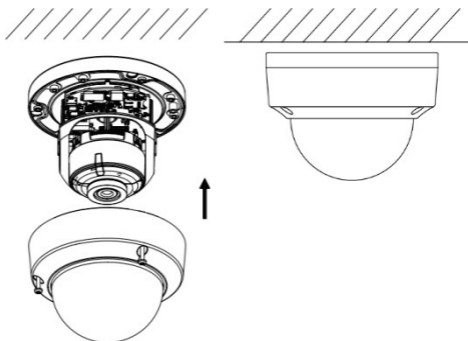

Using the camera with a TruVision recorder or another system

Please refer to the NVR/DVR user manuals for instructions on connecting and operating the camera with these systems.

Using the camera with TruVision Navigator

A camera must be connected to an Interlogix NVR in order to be operated by TruVision Navigator. Please refer to the TruVision Navigator user manual for instructions on operating the camera with TruVision Navigator.

Specifications

TruVision IP bullet cameras

Electrical

Voltage input	12 VDC, PoE (IEEE 802.3af)
---------------	----------------------------

Power consumption	3MPX: Max. 7 W 8MPX: Max. 7.5 W
-------------------	------------------------------------

Miscellaneous

Connectors	12 VDC Power Input, Network Port (PoE)
------------	--

Operating temperature	-30 to +60 °C (-22 to +140°F)
-----------------------	-------------------------------

Dimensions	70 × 155.03 mm (2.76 x 6.1 in.)
------------	------------------------------------

Weight	410 g (0.9 lbs.)
--------	------------------

Environmental rating	IP67
----------------------	------

TruVision IP turret dome

Electrical

Voltage input	12 VDC, PoE (IEEE 802.3af)
---------------	----------------------------

Power consumption	3MPX: Max. 7 W 8MPX: Max. 7 W
-------------------	----------------------------------

Miscellaneous

Connectors	12 VDC Power Input, Network Port (PoE)
------------	--

Operating temperature	-30 to +60 °C (-22 to +140 °F)
-----------------------	--------------------------------

Dimensions	127.3 × 95.9 mm (5.01 × 3.78 in.)
------------	--------------------------------------

Weight	620 g (1.37 lbs.)
--------	-------------------

Environmental rating	IP67
----------------------	------

TruVision IP dome cameras

Electrical

Voltage input	12 VDC, PoE (IEEE 802.3af)
---------------	----------------------------

Power consumption	3MPX: Max. 7W 8MPX: Max. 9W
-------------------	--------------------------------

Miscellaneous

Connectors	Network Port(PoE), Audio In/Out, Alarm In/Out, 12 VDC Power Port
------------	--

Operating temperature	-30 to +60 °C (-22 to 140°F)
-----------------------	------------------------------

Dimensions	111 × 82.4 mm (4.4 × 3.2 in.)
Weight	500 g (1.1 lbs.)
Environmental rating	IP67, IK10

Pin definitions

There are eight wires on a standard UTP/STP cable and each wire is color-coded. The following shows the pin allocation and color of straight and crossover cable connection:

Figure 4: Straight-through cable

1	White/Orange		White/Orange	1
2	Orange		Orange	2
3	White-Green		White-Green	3
4	Blue		Blue	4
5	White/Blue		White/Blue	5
6	Green		Green	6
7	White/Brown		White/Brown	7
8	Brown		Brown	8

Figure 5: Cross-over cable

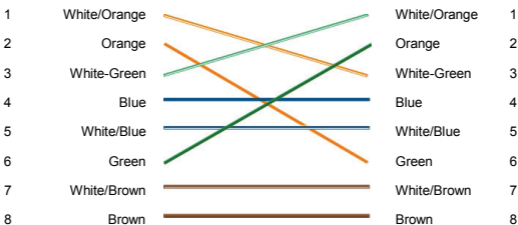

Please make sure your connected cables have the same pin assignment and color as above before deploying the cables in your network.

