

TruVision Series 3 IP Camera Installation Guide

P/N 1073188-EN • REV F • ISS 19OCT17

Copyright	© 2017 United Technologies Corporation. Interlogix is part of UTC Climate, Controls & Security, a unit of United Technologies Corporation. All rights reserved.
Trademarks and patents	Trade names used in this document may be trademarks or registered trademarks of the manufacturers or vendors of the respective products.
Manufacturer	Interlogix 2955 Red Hill Avenue, Costa Mesa, CA 92626-5923, USA Authorized EU manufacturing representative: UTC Fire & Security B.V. Kelvinstraat 7, 6003 DH Weert, The Netherlands
Certification	
FCC compliance	Class A: This equipment has been tested and found to comply with the limits for a Class A digital device, pursuant to part 15 of the FCC Rules. These limits are designed to provide reasonable protection against harmful interference when the equipment is operated in a commercial environment. This equipment generates, uses, and can radiate radio frequency energy and, if not installed and used in accordance with the instruction manual, may cause harmful interference to radio communications. Operation of this equipment in a residential area is likely to cause harmful interference in which case the user will be required to correct the interference at his own expense.
FCC conditions	This device complies with Part 15 of the FCC Rules. Operation is subject to the following two conditions: (1) This device may not cause harmful interference. (2) This Device must accept any interference received, including interference that may cause undesired operation.
ACMA compliance	Notice! This is a Class A product. In a domestic environment this product may cause radio interference in which case the user may be required to take adequate measures.
Canada	This Class A digital apparatus complies with CAN ICES-003 (A)/NMB-3 (A). Cet appareil numérique de la classe A est conforme à la norme CAN ICES-003 (A)/NMB-3 (A).

European Union directives

This product and - if applicable - the supplied accessories too are marked with "CE" and comply therefore with the applicable harmonized European standards listed under the EMC Directive 2014/30/EU, the RoHS Directive 2011/65/EU.



2012/19/EU (WEEE directive): Products marked with this symbol cannot be disposed of as unsorted municipal waste in the European Union. For proper recycling, return this product to your local supplier upon the purchase of equivalent new equipment, or dispose of it at designated collection points. For more information see: www.recyclethis.info



2013/56/EU and 2006/66/EC (battery directive): This product contains a battery that cannot be disposed of as unsorted municipal waste in the European Union. See the product documentation for specific battery information. The battery is marked with this symbol, which may include lettering to indicate cadmium (Cd), lead (Pb), or mercury (Hg). For proper recycling, return the battery to your supplier or to a designated collection point. For more information see: www.recyclethis.info.

Product warnings and disclaimers

THESE PRODUCTS ARE INTENDED FOR SALE TO, AND INSTALLATION BY, AN EXPERIENCED SECURITY PROFESSIONAL. UTC FIRE & SECURITY CANNOT PROVIDE ANY ASSURANCE THAT ANY PERSON OR ENTITY BUYING ITS PRODUCTS, INCLUDING ANY "AUTHORIZED DEALER", IS PROPERLY TRAINED OR EXPERIENCED TO CORRECTLY INSTALL SECURITY RELATED PRODUCTS.

For more information on warranty disclaimers and product safety information, please check www.firesecurityproducts.com or scan the following code:



Contact information and manuals

For contact information go to: www.interlogix.com or www.firesecurityproducts.com

To get translations for this and other product manuals go to: www.firesecurityproducts.com

Content

Introduction 3

Product overview 3

Installation 5

Installation environment 5

Package contents 6

Cable requirements 22

Camera description 22

Setting up the camera 30

Accessing the SD card 30

Mounting the IP fixed lens bullet camera 31

Mounting the IP VF lens bullet camera and the IP motorized lens bullet camera (without the supplied back box) 32

Mounting the IP VF lens dome camera and IP motorized lens dome camera 38

Mounting the IP fixed lens dome camera 43

Mounting the IP wedge dome camera 47

Mounting the IP turret camera 50

Using the camera with a recorder 55

Using the camera with TruVision Navigator 55

Specifications 56

TruVision IP fixed lens bullet cameras 56

TruVision IP VF lens bullet cameras 56

TruVision IP motorized lens bullet cameras 57

TruVision IP VF lens dome cameras 57

TruVision IP motorized lens dome cameras 58

TruVision IP fixed lens dome 59

TruVision IP wedge cameras 59

TruVision IP turret cameras 60

Pin definitions 61

Introduction

Product overview

This is the installation guide for TruVision Series 3 IP camera models:

IP fixed lens bullet camera:

- TVB-5301 (2MPX Bullet, 4 mm lens)
- TVB-5302 (4MPX Bullet, 4 mm lens)

IP VF lens bullet camera:

- TVB-5303 (2MPX Bullet, 2.8 to 12 mm VF lens)
- TVB-5304 (4MPX Bullet, 2.8 to 12 mm VF lens)

IP motorized lens bullet camera:

- TVB-5305 (2MPX Bullet, 2.8-12 mm VF motorized lens)
- TVB-5306 (4MPX Bullet, 2.8-12 mm VF motorized lens)

IP fixed lens dome camera:

- TVD-5301 (2MPX Plastic Dome, 2.8 mm lens)
- TVD-5302 (4MPX Plastic Dome, 2.8 mm lens)

IP VF lens dome camera:

- TVD-5303 (2MPX VF Dome)
- TVD-5304 (4MPX VF Dome)

IP motorized lens dome camera:

- TVD-5305 (2MPX Dome, 2.8-12 mm VF Motorized lens)
- TVD-5306 (4MPX Dome, 2.8-12 mm VF Motorized lens)

IP wedge camera:

- TVW-5301 (2MPX Wedge, 2.0 mm lens, Gray)
- TVW-5302 (2MPX Wedge, 2.8 mm lens, Gray)
- TVW-5303 (2MPX Wedge, 2.8 mm lens, White)
- TVW-5304 (2MPX Wedge, 2.8 mm lens, Black)
- TVW-5305 (4MPX Wedge, 2.8 mm lens, Gray)

IP turret camera:

- TVT-5301 (2MPX Turret, 2.8 mm lens, Gray)
- TVT-5302 (2MPX Turret, 2.8 mm lens, White)
- TVT-5303 (2MPX Turret, 2.8 mm lens, Black)
- TVT-5304 (4MPX Turret, 2.8 mm lens, Gray)
- TVT-5305 (4MPX Turret, 2.8 mm lens, White)
- TVT-5306 (4MPX Turret, 2.8 mm lens, Black)
- TVT-5307 (4MPX Turret, 4.0 mm lens, White)

Installation

This section provides information on how to install the cameras.

Installation environment

When installing your product, consider these factors:

- **Electrical:** Install electrical wiring carefully. It should be done by qualified service personnel. Always use a proper PoE switch or a 12 VDC UL listed Class 2 or CE certified power supply to power the camera. Do not overload the power cord or adapter.
- **Ventilation:** Ensure that the location planned for the installation of the camera is well ventilated.
- **Temperature:** Do not operate the camera beyond the specified temperature, humidity or power source ratings. The operating temperature of the camera is between -30 to +60°C (-22 to 140°F). Humidity is below 90%.
- **Moisture:** Do not expose the camera to rain or moisture, or try to operate it in wet areas. Turn the power off immediately if the camera is wet and ask a qualified service person for servicing. Moisture can damage the camera and also create the danger of electric shock.
- **Servicing:** Do not attempt to service this camera yourself. Any attempt to dismantle this product will invalidate the warranty and may also result in serious injury. Refer all servicing to qualified service personnel.
- **Cleaning:** Do not touch the sensor modules with fingers. If cleaning is necessary, use a clean cloth with some ethanol and wipe the camera gently. If the camera will not

be used for an extended period of time, put on the lens cap to protect the sensors from dirt.

Package contents

Check the package and contents for visible damage. If any components are damaged or missing, do not attempt to use the unit; contact the supplier immediately. If the unit is returned, it must be shipped back in its original packaging.

IP fixed lens bullet camera

Camera:

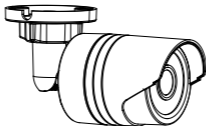

Drill template:



Screws:

Drywall anchor
7.5 × 24.5 mm (3 pcs)



Screw
M4 × 25 mm (3 pcs)



Water joint: Provides water resistance to network cable connector.

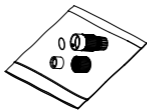

12 VDC connector: Two terminal connector with positive and negative indicators.



Installation manual:

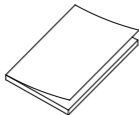

CD with manuals and TruVision Device Manager:



Equipment and Battery Disposal sheets:

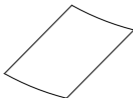

IP VF lens bullet camera

Camera:

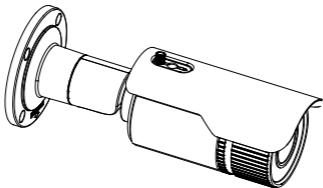

Drill template:

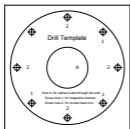

Screws:

Drywall anchor
7.5 × 24.5 mm (4 pcs)



Screw
M4 × 25 mm (4 pcs)



Water joint: Provides water resistance to network cable connector.

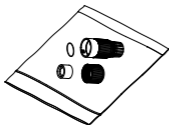

12 VDC connector:
Two terminal connector
with positive and
negative indicators.



Video test cable:



Screws: M4.8 × 8 (4 pcs)



Plastic G3/4 cable adapter

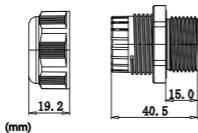

Equipment and Battery
Disposal sheets:

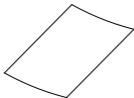

Back box:



Torx wrench:



CD with manuals and
TruVision Device
Manager:



Installation manual:

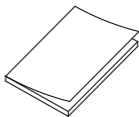

IP motorized lens bullet camera

Camera:

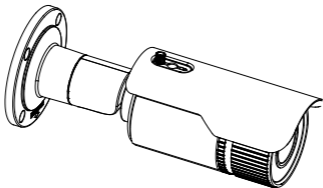

Drill template:



Screws:

Drywall anchor
7.5 × 24.5 mm (4 pcs)



Screw
M4 × 25 mm (4 pcs)



Video test cable:



Back box:



Water joint: Provides water resistance to network cable connector.

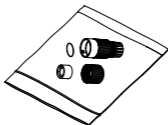

Screws: M4.8 × 8 (4 pcs)



Plastic G3/4 cable adapter

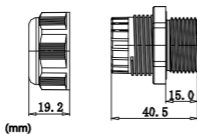

Equipment and Battery Disposal sheets:

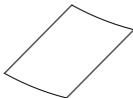

12 VDC connector: Two terminal connector with positive and negative indicators.



Torx wrench:



CD with manuals and TruVision Device Manager:



Installation manual:

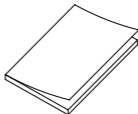

IP fixed lens dome camera

Camera:

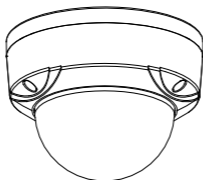

Template:



Screws:

Drywall anchor
7.5 × 24.5 mm (3 pcs)



Screw
M4 × 25 mm (3 pcs)



Water joint: Provides water resistance to network cable connector.

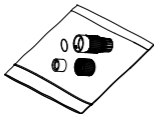

12 VDC connector:
Two terminal connector with positive and negative indicators.



Screws: 4 × 75 mm (3 pcs)



Torx wrench:



Installation manual:



CD with manuals and
TruVision Device
Manager:



Equipment and Battery
Disposal sheets:

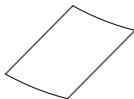

IP VF lens dome camera

Camera:

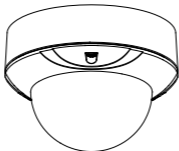

Drill template:



Screws:

Drywall anchor
7.5 × 24.5 mm (4 pcs)



Screw
M4 × 25 mm (4 pcs)



Screws: M4 × 9 (3 pcs)



Mounting adaptor plate:

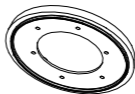

Water joint: Provides water resistance to network cable connector.

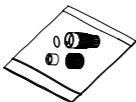

12 VDC connector:
Two terminal connector
with positive and
negative indicators.



Plastic G3/4 cable adapter:

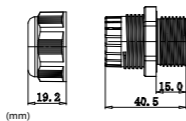

Torx wrench:



Equipment and Battery
Disposal sheets:

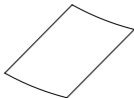

Installation manual:

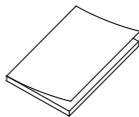

CD with manuals and
TruVision Device Manager:



IP motorized lens dome camera

Camera:

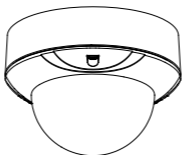

Drill template:



Screws:

Drywall anchor
7.5 × 24.5 mm (4 pcs)



Screw
M4 × 25 mm (4 pcs)



Screws: M4 × 9 (3 pcs)



Mounting adaptor plate:

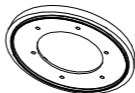

Water joint: Provides water resistance to network cable connector.

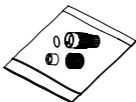

12 VDC connector:
Two terminal connector with positive and negative indicators.



Torx wrench:



Video test cable:



Plastic G3/4 cable adapter:

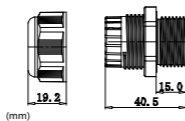

CD with manuals and
TruVision Device
Manager:



Equipment and Battery
Disposal sheets:

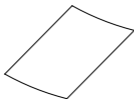

Installation manual:

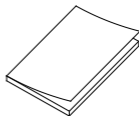

IP wedge camera

Camera:

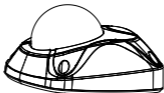

Camera drill template:

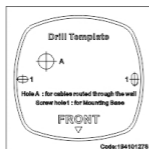

Adapter plate drill template:

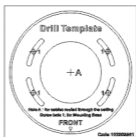

Water joint: Provides water resistance to network cable connector.

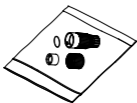

12 VDC connector:
Two terminal connector with positive and negative indicators.



Lens adjustment tool:



Adapter plate:



Screws: M4 × 8 (2 pcs)



Torx wrench:



Screws:

Drywall anchor
7.5 × 24.5 mm (3 pcs)



Screw
M4 × 25 mm (3 pcs)



Installation manual:

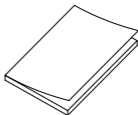

CD with Configuration
manual and TruVision Device
Finder:



Equipment and Battery
Disposal sheets:

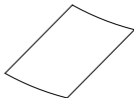

IP turret camera

Camera:

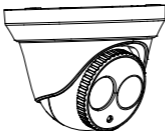

Water joint: Provides water resistance to network cable connector.

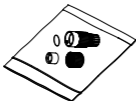

12 VDC connector: 2-terminal connector with positive and negative indicators.



Camera drill template:



Adapter plate:

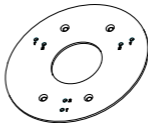

Screws:

Drywall anchor
7.5 × 24.5 mm (3 pcs)



Screw
M4 × 25 mm (3 pcs)



Screw PM6-32 × 10
(4 pcs, used to attach the
turret camera to a 2
Gang electrical box):



Screw KM4 × 8 (4 pcs, used to attach the adapter to the brackets)

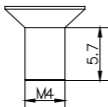

Screw PM4 × 8 (3pcs):



CD with Configuration manual and TruVision Device Finder:



Installation manual:

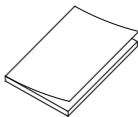

Equipment and Battery Disposal sheets:

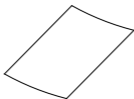

CAUTION: Use direct plug-in UL listed power supplies marked Class 2/CE certified or LPS (limited power source) of the required output rating as listed on the unit.

CAUTION: Risk of explosion if the battery is replaced by an incorrect type. Dispose of used batteries according to the instructions.

Cable requirements

For proper operation, adhere to the following cable and power requirements for the cameras. Category 5 cabling or better is recommended. All network cabling must be installed according to applicable codes and regulations.

Camera description

Figure 1: IP fixed lens bullet camera

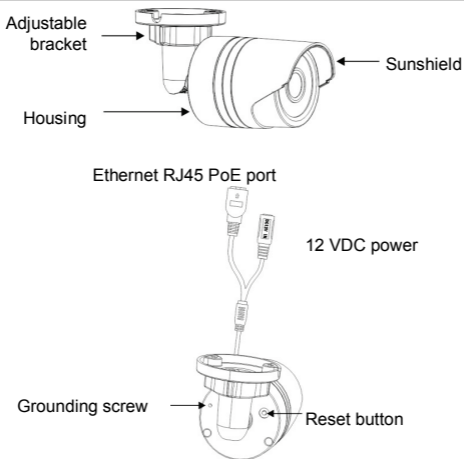
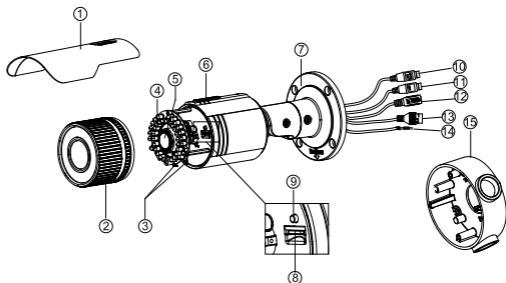
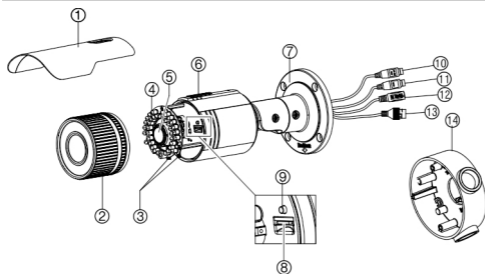

Figure 2: IP VF bullet camera



- | | |
|----------------------|---|
| 1. Sunshield | 9. Reset button |
| 2. Front cover | 10. Audio I/O |
| 3. Lens adjustment | 11. Alarm I/O |
| 4. IR LEDs | 12. 12 VDC power |
| 5. Lens | 13. Ethernet RJ45 PoE port |
| 6. Waterproof film | 14. Aux power output
(12 VDC, 50 mA) |
| 7. Base | 15. Back box |
| 8. SD/SDHC/SDXC slot | |

Figure 3: IP motorized lens bullet camera



- | | |
|----------------------|----------------------------|
| 1. Sunshield | 9. Reset button |
| 2. Front cover | 10. Audio I/O |
| 3. Lens adjustment | 11. Alarm I/O |
| 4. IR LEDs | 12. 12 VDC power |
| 5. Lens | 13. Ethernet RJ45 PoE port |
| 6. Waterproof film | 14. Back box |
| 7. Base | |
| 8. SD/SDHC/SDXC slot | |

Figure 4: IP VF lens dome camera

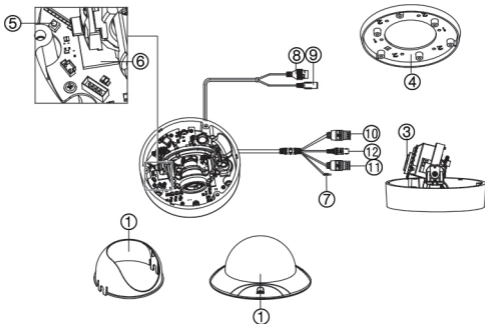

- | | |
|---------------------------|-------------------------------------|
| 1. Housing cover | 7. Aux power output (12 VDC, 50 mA) |
| 2. Dome liner | 8. Ethernet RJ45 PoE port |
| 3. Lens | 9. 12 VDC power |
| 4. Mounting plate adapter | 10. Audio I/O |
| 5. Reset button | 11. Alarm I/O |
| 6. SD/SDHC/SDXC slot | 12. Analog video output (BNC) |

Figure 5: IP motorized lens dome camera

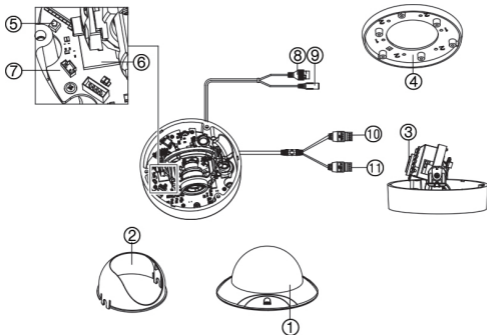

- | | |
|---------------------------|--------------------------------|
| 1. Housing cover | 7. Video test cable connection |
| 2. Dome liner | 8. Ethernet RJ45 PoE port |
| 3. Lens | 9. 12 VDC power |
| 4. Mounting plate adapter | 10. Audio I/O |
| 5. Reset button | 11. Alarm I/O |
| 6. SD/SDHC/SDXC slot | |

Figure 6: IP fixed lens dome camera

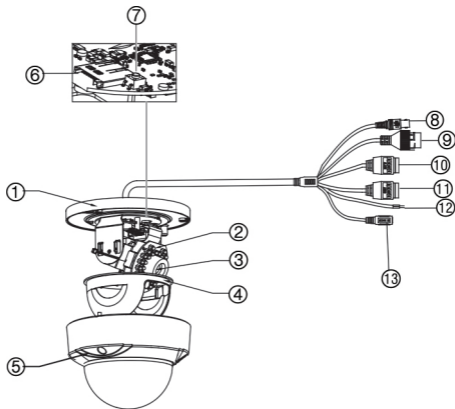

- | | |
|----------------------|--------------------------------------|
| 1. Base | 8. Analog video output (BNC) |
| 2. IR LEDs | 9. Ethernet RJ45 PoE port |
| 3. Lens | 10. Alarm I/O |
| 4. Dome liner | 11. Audio I/O |
| 5. Housing cover | 12. Aux power output (12 VDC, 50 mA) |
| 6. SD/SDHC/SDXC slot | 13. 12 VDC power |
| 7. Reset button | |

Figure 7: IP wedge camera

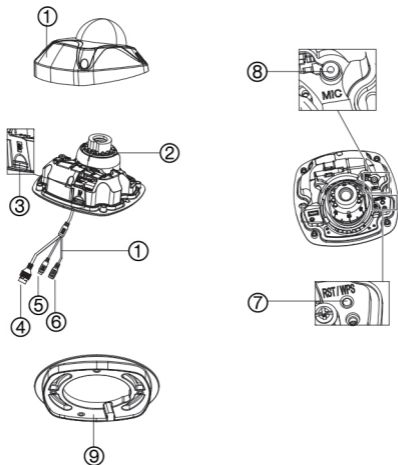

- | | |
|---------------------------|-------------------------------|
| 1. Housing cover | 6. Audio output and alarm I/O |
| 2. Lens | 7. Reset button |
| 3. SD/SDHC/SDXC slot | 8. Microphone |
| 4. Ethernet RJ45 PoE port | 9. Adapter plate |
| 5. 12 VDC power | |

Figure 8: IP turret camera

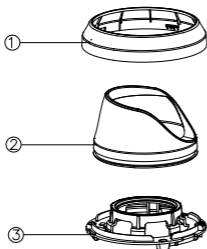

1. Trim ring
2. Housing
3. Base

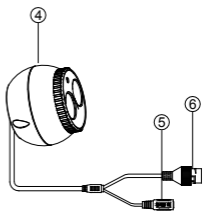

4. Lens assembly
5. 12 VDC power
6. Ethernet RJ45 PoE port

Setting up the camera

Note: If the light source where the camera is installed experiences rapid, wide variations in lighting, the camera may not operate as intended.

To quickly put the camera into operation:

1. Prepare the mounting surface.
2. Mount the camera on the mounting surface using the appropriate hardware.
3. Set up the camera's network and streaming parameters so that the camera can be controlled over the network. For further information, please refer to the "TruVision IP Series 3 IP Camera Configuration Manual".
4. Program the camera to suit its location. For further information, please refer to the "TruVision IP Series 3 IP Camera Configuration Manual".

Accessing the SD card

Insert a Micro SD card with up to 128GB capacity for local storage as a backup in case, for example, the network fails (see Figure 2 on page 23). The SD card is not supplied with the camera.

For the IP VF lens dome and IP motorized dome cameras, point the lens vertically upwards to access the SD card slot.

For the IP VF bullet and IP motorized bullet cameras, remove the sunshield and open the front cover to access the SD card slot.

Video and log files stored on the Micro SD card can only be accessed via the web browser.

Note: There is no Micro SD card slot in the mini fixed lens bullet and turret cameras.

Mounting the IP fixed lens bullet camera

Mount the camera on a ceiling or wall.

To mount the IP fixed lens bullet camera:

1. Use the supplied template to mark out the mounting area. If you need to route the cables from the camera base, cut out a cable access hole in the mounting surface.

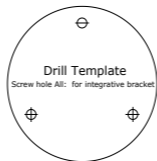

2. Secure the mounting base to the ceiling or wall using the three mounting screws and drywall anchors.

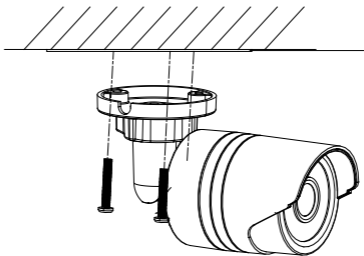

- Loosen the large nut at the base of the mounting bracket to adjust the camera's viewing angle.

Pan direction: 0 to 360° adjustable

Tilt direction: 0 to 90° adjustable

Rotate direction: 0 to 360° adjustable

- Adjust the lens to the desired surveillance angle. Tighten the adjustable nuts to complete the installation.

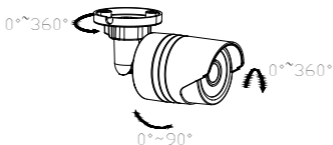

Mounting the IP VF lens bullet camera and the IP motorized lens bullet camera (without the supplied back box)

To mount the IP VF lens bullet camera to a surface:

- Use the supplied template to mark out the mounting area. Drill mounting holes in the surface using the holes labelled number "1" on the drill template.

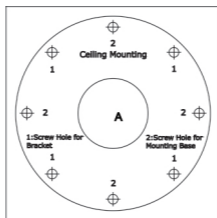

2. To route the cable harness through the mounting surface, cut a cable access hole in the mounting surface, referencing the letter "A" on the drill template. Skip this step if you want to route the cables on the surface.
3. Secure the camera to the surface with the four mounting screws and drywall anchors.

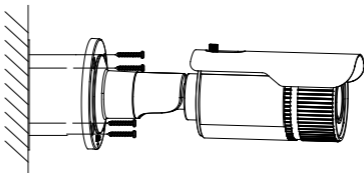

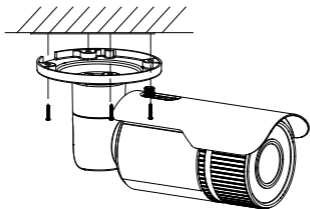

To install the SD card:

1. Rotate the screw that secures the sunshield counterclockwise to loosen it. Slide the sun shield so that the hole in the sunshield lines up with the screw head.

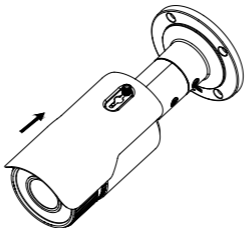

2. Remove the sun shield. Remove the lens cover by rotating it counterclockwise.

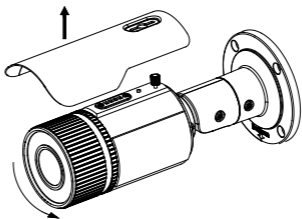

3. Insert the SD card in the SD card slot.

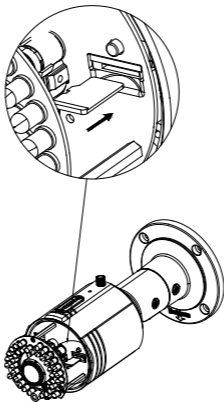

4. Reinstall the lens cover by rotating the assembly clockwise. Reinstall the sunshield.

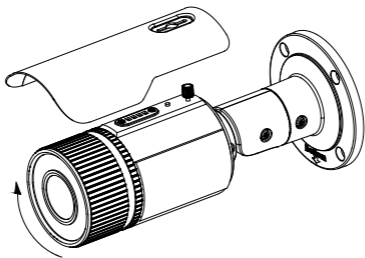

5. Rotate the sunshield screw clockwise to tighten it.

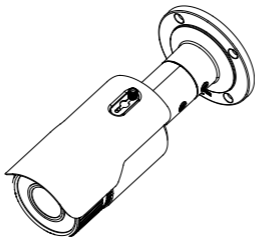

6. To ensure that the camera maintains its IP66 rating, when rotating the lens cover clockwise align the red bar on the label of the lens cover with red bar on the label that is located on the camera housing.

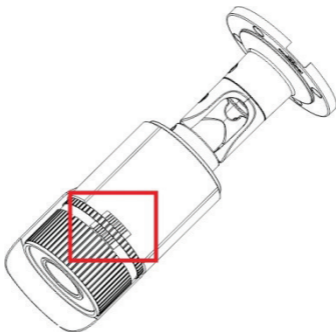

To mount the IP VF lens bullet camera and the IP Motorized lens bullet camera with a back box:

1. Use the supplied template to mark out the mounting area. Drill mounting holes in the surface using the holes labeled number "2" on the drill template.
2. To route the cable harness through the mounting surface, cut a cable access hole in the mounting surface, referencing the letter "A" on the drill template. Skip this step if you want to route the cables on the surface.
3. Secure the back box to the wall using the mounting hardware provided.
4. Route the cables of the camera.
5. Hook the camera to the back box using the safety lanyard.
6. Secure the camera to the back box with the four M4 x 9 screws.

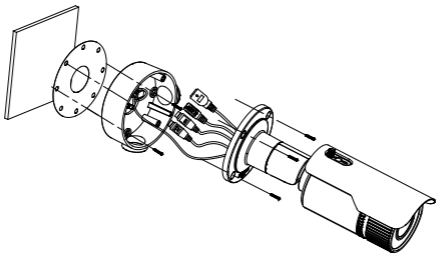

Mounting the IP VF lens dome camera and IP motorized lens dome camera

Note: For planning purposes, there are several cable routing options available:

- Route the interconnect cables through the mounting surface, straight out the back of the dome.
– Or –
- Route the interconnect cables through the side access hole of the dome camera housing. A G3/4 cable adapter is provided
– Or –
- Use the mounting adapter plate to mount the dome on a single or double gang electrical box.

To mount the IP VF lens dome camera and the IP motorized lens dome camera on a surface:

1. Loosen the three Torx screws at the edge of the dome housing using the supplied Torx wrench.

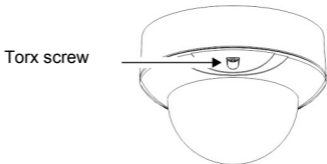

2. Remove the dome housing and then remove the black plastic inner liner.

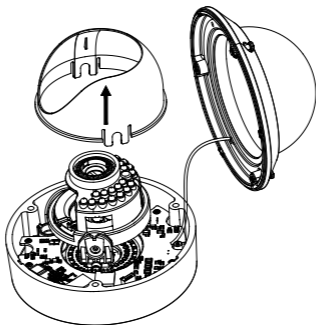

3. Use the supplied template to mark out the mounting area of the dome camera. Depending on how you want to route the interconnect cables, route them out of the side of the dome housing or through the mounting surface.

Drill the three screw holes on the ceiling in the mounting surface using with the supplied drill template. Use number “1” as reference.

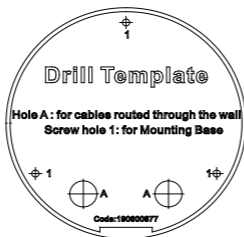

- To route the cable harness through the mounting surface, cut a cable access hole in the mounting surface, referencing the letter “A” on the drill template. Skip this step if you want to route the cables on the surface.
- Attach the camera to the mounting surface. Secure the camera with the supplied screws and anchors, as shown below.

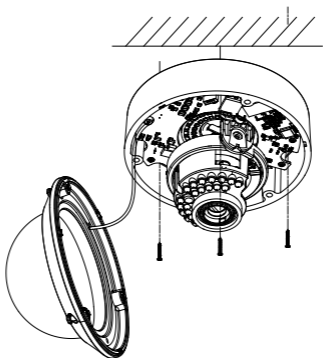

6. Connect the appropriate cables.

To mount the IP VF lens dome camera and the IP Motorized lens dome camera on a single or double gang electrical box:

1. Follow steps 1 to 3 in the section above, "To mount the IP VF lens dome camera and the IP motorized lens dome camera on a surface".
2. Install the mounting plate adapter to a single gang electrical box referencing number "2" on the adapter plate, or to a double gang box referencing number "1" on the adapter plate.

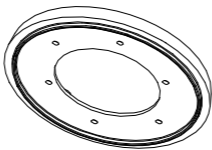

3. Route the cables through the center of the adapter plate and connect the appropriate cables inside the electrical box.
4. Attach the dome to the adapter plate.
5. Connect the video output connector to the monitor.
Connect the power connector to the power supply.
6. Adjust the image and focus.
 - a) Three-axis adjustment.
View the camera image using the monitor. Rotate the lens assembly (see image below) to adjust the panning position of the camera. Move the assembly up and down to adjust the tilt position of the camera. Rotate the inner lens assembly to obtain the desired surveillance angle.
 - b) Zoom and focus adjustment.
Loosen the zoom lever and move the lever between T(Tele) and W(Wide) to obtain the appropriate angle of view.
 - c) Tighten the zoom lever.
Loosen the focus lever and move the lever between F(Far) and N(Near) to obtain the optimum focus.
Tighten the focus lever.

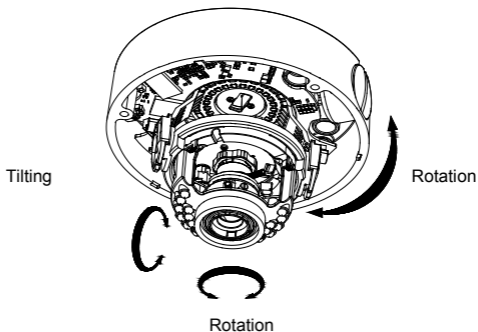

Mounting the IP fixed lens dome camera

To mount the IP fixed lens dome camera on a surface:

1. Use the supplied template to mark out the mounting area. Drill mounting holes in the surface using the holes labeled number "1" on the drill template.

To route the cable harness through the mounting surface, cut a cable access hole in the mounting surface, referencing the letter "A" on the drill template. Skip this step if you want to route the cables on the surface.

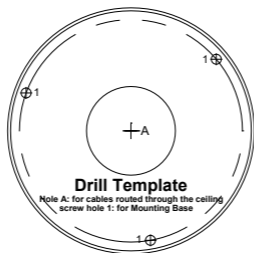

- Using the supplied Torx wrench, loosen the screws to remove the dome housing.

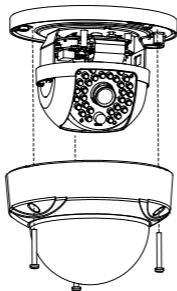

- Attach the dome on the mounting surface using the supplied hardware.

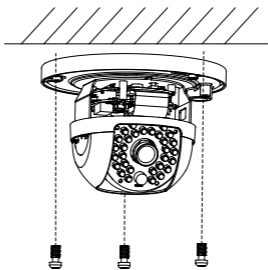

Note: If required, route cables through the side opening of the mounting base.

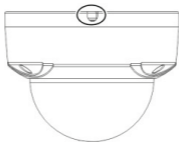

4. Loosen the tilt adjust screws (see image below) and adjust the tilt position of the lens assembly within a range of 75 degrees. Retighten the tilt adjust screws.

Rotate the dome liner to adjust the pan position within a range of 355 degrees. Rotate the lens assembly (0 to 355°) to obtain the desired surveillance angle.

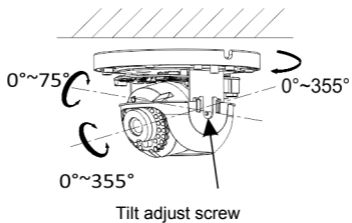

5. (Optional) If using a micro SD card (not included):

To remove the SD card, push the micro SD card forward.
The micro SD card will spring out.

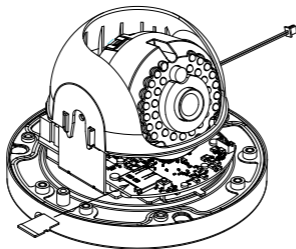

6. Re-attach the dome housing and tighten the Torx screws.

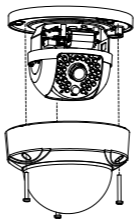

Mounting the IP wedge dome camera

To mount the IP wedge dome camera on a surface:

1. Use the supplied template (supplied) to mark out the mounting area. Drill mounting holes in the surface using the holes labeled number "1" on the drill template.

To route the cable harness through the mounting surface, cut a cable access hole in the mounting surface, referencing the letter "A" on the drill template. Skip this step if you want to route the cables on the surface.

2. Secure the adapter plate to the mounting surface using the drill template (optional).

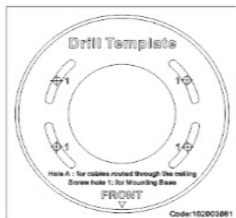

Note: If required, remove the knockout (A) on the side of the adapter plate to allow for cable access.

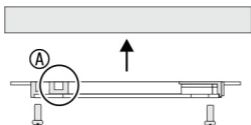

3. Loosen the Torx screws with a Torx wrench (supplied) to remove the dome housing.

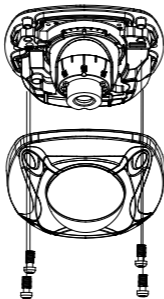

4. Attach the camera base to the adapter plate or directly to the mounting surface.

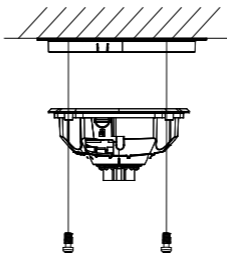

5. Loosen the locking screw, located near the lens assembly using the Torx wrench. Align the Lens Adjustment Tool with the two small holes located on the camera assembly. Rotate (pan) the camera assembly using the Lens Adjustment Tool until the lens is positioned in the correct location. The tool is also used to adjust the tilt angle.

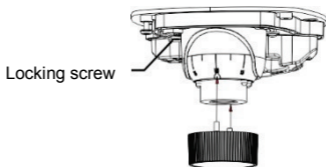

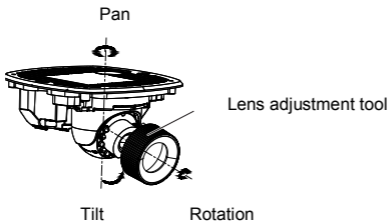

6. Re-attach the dome housing cover to the camera base.

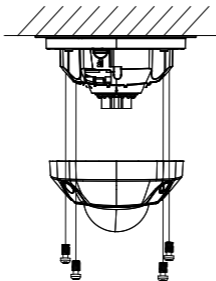

Mounting the IP turret camera

To mount the IP turret camera on a surface:

1. Use the supplied template (supplied) to mark out the mounting area. Drill mounting holes in the surface using the holes labeled number "1" on the drill template.

To route the cable harness through the mounting surface, cut a cable access hole in the mounting surface,

referencing the letter “A” on the drill template. Skip this step if you want to route the cables on the surface.

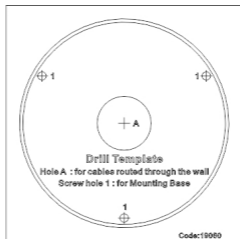

Use the supplied adapter plate if installing the turret camera to a wall mount or other accessory. Fix the adapter plate to the accessory with three PM4X8 screws, referencing number “2”.

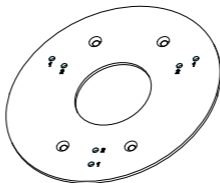

2. Rotate the trim ring counterclockwise to remove it from the camera.

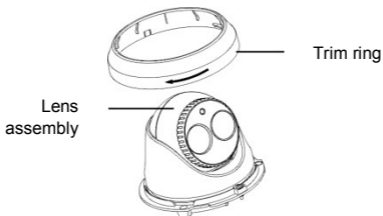

3. There two options for routing the cables.

Route the cables directly out of the bottom of the camera or through the side access point shown below. Remove one of the knockouts (using pliers) on the edge of the trim ring to provide cable access.

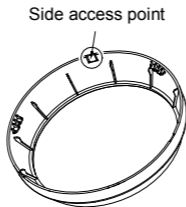

4. Connect the corresponding power and network cables.
5. Attach the camera to the mounting surface using the supplied hardware.

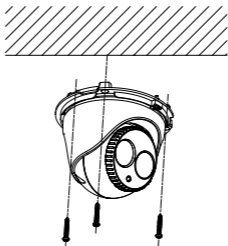

6. Adjust the lens.
- Loosen the locking screw using a Philips screw driver.
 - Rotate the lens assembly to adjust the pan angle.
Rotate the lens assembly to adjust the tilt angle.
 - Tighten the locking screw to secure the lens at the desired surveillance angle.

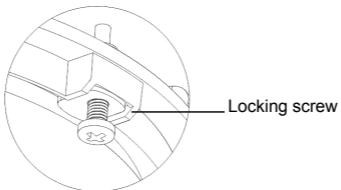

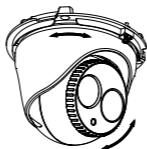
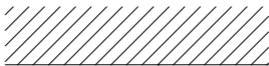

7. Attach the trim ring to the camera and rotate it clockwise to secure it.

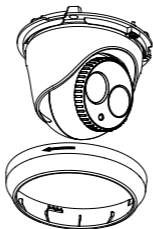

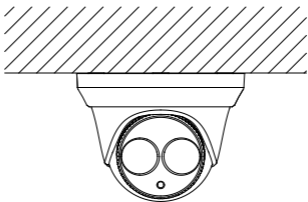

Using the camera with a recorder

Please refer to the recorder user manuals for instructions on connecting and operating the camera with these systems.

Using the camera with TruVision Navigator

A camera must be connected to an Interlogix NVR or hybrid DVR in order to be operated by TruVision Navigator. Please refer to the TruVision Navigator user manual for instructions on operating the camera with the TruVision Navigator.

Specifications

TruVision IP fixed lens bullet cameras

Electrical

Voltage input	12 VDC, PoE (IEEE 802.3af)
---------------	----------------------------

Power consumption	Max. 5 W
-------------------	----------

Miscellaneous

Connectors	DC jack flying lead, RJ45 flying lead
------------	---------------------------------------

Operating temperature	-30 to +60°C (-22 to +140°F)
-----------------------	------------------------------

Dimensions	60 × 153 mm (2.3 × 6.0 in.)
------------	-----------------------------

Weight	373 g (0.82 lb.)
--------	------------------

Environmental rating	IP67
----------------------	------

TruVision IP VF lens bullet cameras

Electrical

Voltage input	12 VDC, PoE (IEEE 802.3af)
---------------	----------------------------

Power consumption	Max. 7.5 W
-------------------	------------

Miscellaneous

Connectors	DC jack flying lead, RJ45 flying lead
------------	---------------------------------------

Operating temperature	-30 to +60°C (-22 to +140°F)
-----------------------	------------------------------

Dimensions	105 × 94.7 × 265.4 mm / 4.13 × 3.74 × 10.4 in. (without back box) 105 × 94.7 × 301.4 mm / 4.13 × 3.74 × 11.86 in. (with back box)
------------	---

Weight	800 g (1.76 lb.)
Environmental rating	IP67

TruVision IP motorized lens bullet cameras

Electrical

Voltage input	12 VDC, PoE (IEEE 802.3af)
Power consumption	Max. 7.5 W

Miscellaneous

Connectors	DC jack flying lead, RJ45 flying lead
Operating temperature	-30 to +60°C (-22 to +140°F)
Dimensions	105 × 94.7 × 265.4 mm / 4.13 × 3.74 × 10.4 in. (without back box) 105 × 94.7 × 301.4 mm / 4.13 × 3.74 × 11.86 in. (with back box)

Weight	800 g (1.76 lb.)
Environmental rating	IP67

TruVision IP VF lens dome cameras

Electrical

Voltage input	12 VDC, PoE (IEEE 802.3af)
Power consumption	Max. 5.5 W

Miscellaneous

Connectors	DC jack flying lead, RJ45 flying lead
------------	---------------------------------------

Operating temperature	-30 to +60°C (-22 to +140°F)
Dimensions (L × W × H)	140 × 100 mm (5.51 × 3.94 in.)
Weight	807 g (1.78 lb.)
Environmental rating	IP67

TruVision IP motorized lens dome cameras

Electrical

Voltage input	12 VDC, PoE (IEEE 802.3af)
Power consumption	Max. 5.5 W

Miscellaneous

Connectors	DC jack flying lead, RJ45 flying lead
Operating temperature	-30 to +60°C (-22 to +140°F)
Dimensions (L × W × H)	140 × 100 mm (5.51 × 3.94 in.)
Weight	807 g (1.78 lb.)
Environmental rating	IP67

TruVision IP fixed lens dome

Electrical

Voltage input	12 VDC, PoE (IEEE 802.3af)
---------------	----------------------------

Power consumption	Max. 5 W
-------------------	----------

Miscellaneous

Connectors	DC jack flying lead, RJ45 flying lead
------------	---------------------------------------

Operating temperature	-30 to +60°C (-22 to +140°F)
-----------------------	------------------------------

Dimensions (L × W × H)	111 × 82 mm (4.4 × 3.2 in.)
------------------------	-----------------------------

Weight	370 g (0.81 lb.)
--------	------------------

Environmental rating	IP67
----------------------	------

TruVision IP wedge cameras

Electrical

Voltage input	12 VDC, PoE (IEEE 802.3af)
---------------	----------------------------

Power consumption	Max. 5 W (Max. 7 W with IR on)
-------------------	--------------------------------

Miscellaneous

Connectors	DC jack flying lead, RJ45 flying lead
------------	---------------------------------------

Operating temperature	-30 to +60°C (-22 to +140°F)
-----------------------	------------------------------

Dimensions (L × W × H)	98 × 89 × 329 mm (3.86 × 3.49 × 12.94 in.)
------------------------	---

Weight	409 g (0.9 lb.)
--------	-----------------

Environmental rating	IP67
----------------------	------

TruVision IP turret cameras

Electrical

Voltage input	12 VDC, PoE (IEEE 802.3af)
Power consumption	Max. 5.5 W (Max. 7.5 W with IR on)

Miscellaneous

Connectors	DC jack flying lead, RJ45 flying lead
Operating temperature	-30 to +60°C (-22 to +140°F)
Dimensions (L × W × H)	127 × 97.5 mm (5 × 3.84 in.)
Weight	548 g (1.21 lb.)
Environmental rating	IP67

Pin definitions

There are eight wires on a standard UTP/STP cable and each wire is color-coded. The following shows the pin allocation and color of straight and crossover cable connection:

Figure 9: Straight-through cable

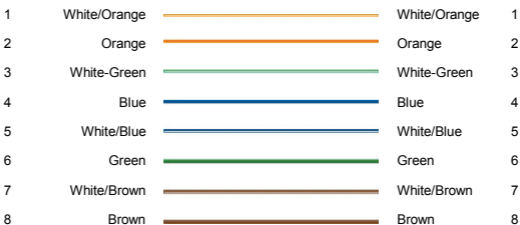
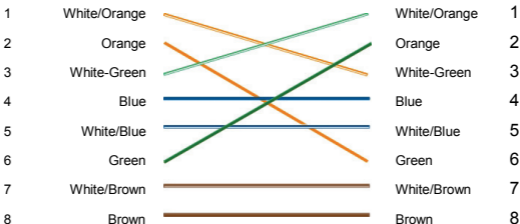

Figure 10: Cross-over cable



Please make sure your connected cables have the same pin assignment and color as above before deploying the cables in your network.

