

TruVision High Definition TVI Vandal Dome Installation Guide

TVD-2402/TVD-4402

TVD-2404/TVD-4404

TVD-2405/TVD-4405

Content

Product overview	4
Camera description	6
Installation	9
Operating temperature range	14
Program	14
Setup menu	19
Specifications	21
Legal and Regulatory information	23

Product overview

This is the Installation Guide for the TruVision High Definition TVI dome TVD-2402/TVD-4402 , TVD-2404/TVD-4404 and TVD-2405/TVD-4405. This guide describes a standard installation.

Package contents

- Camera with power and video output cables
- 4 screws and 4 anchors for wall or ceiling installation

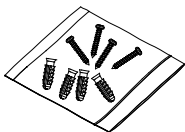

- Template
- 3 screws to install the camera to the back box

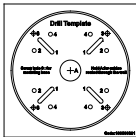

- Hex wrench



- Monitor output cable



- Spare rubber knockout

There is a rubber knockout on the camera back box. This is for future use.



- Installation Guide

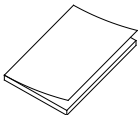

- CD



- WEEE and Battery Disposal sheets

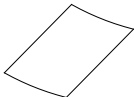

Camera description

TVD-2402/TVD4402:

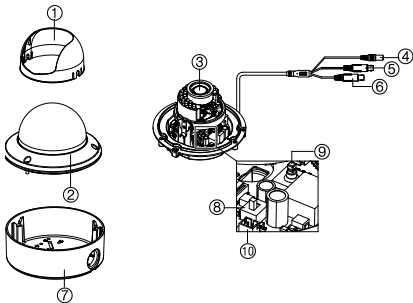

1. Dome liner
2. Bubble
3. Lens
4. Power cable
5. CVBS video output cable (black)
6. TVI video output cable (grey)
7. Back box
8. Switch (Left = WDR / Right = CVBS)
9. Menu button
10. CVBS output port

TVD-2404/4404 and TVD2405/4405:

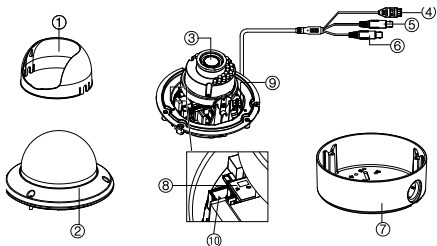

1. Dome liner
2. Bubble
3. Lens
4. Power cable
5. CVBS video output cable (black)
6. TVI video output cable (grey)
7. Back box
8. Switch (Left = WDR / Right = CVBS)
9. Menu button
10. CVBS output port

Note:

Please check the camera output settings before setting up a system. The TVI video output can be only connected to DVR with TVI signal input. The CVBS output supports a standard CVBS monitor (or test monitor), an encoder or a DVR.

For 720P Dome cameras TVD-2402/TVD-4202, the CVBS and TVI output can not be used at the same time. Use the built-in switch to select the camera video output.

For 1080P Dome cameras TVD-2404/TVD-4404 and TVD-2405/TVD-4405, use the built-in switch to enable/disable the WDR feature. When the WDR feature is enabled, the CVBS output will be blocked.

Installation

To install the camera on a ceiling:

1. Using the template, place it level against the mounting surface and mark the position of the mounting holes.

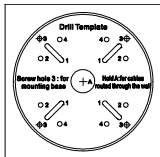

2. Following all local safety regulations, drill and prepare the mounting holes.
3. Remove the camera from its back box.
4. Loosen the three screws on the edge of the bubble with the supplied hex wrench.
5. Remove the bubble and the dome liner.

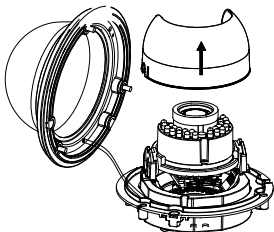

6. Secure the back box to the ceiling with the supplied screws.

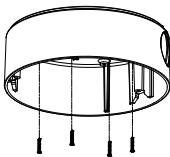

Note: Please remove the rubber knockout for cable routing outside of the camera, when required.

7. Using a 75-ohm coaxial video cable, connect the camera TVI video output to a TVI DVR, and connect a 12 VDC or 24 VAC power supply to the power cable.
8. Align the camera with the back box and tighten the screws to fasten the camera to the back box.

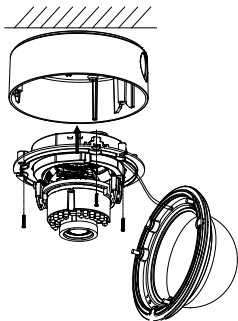

7. Adjust the surveillance angle:
 - 1) View the camera image on a monitor.

- 2) Rotate the camera block to adjust the pan direction [0 to 355°].
- 3) Loosen the tilting lock screw.
- 4) Rotate the camera block to adjust the tilt direction [0 to 90°].
- 5) Tighten the tilting lock screw.
- 6) Rotate the camera lens holder [0 to 355°] to adjust the lens to the surveillance angle.

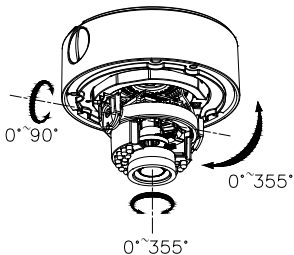

8. Zoom and focus adjustment

- a) Manually adjust the zoom and focus of TVD-2402/TVD-4402 and TVD-2404/TVD-4404.
 - 1) View the camera image using the monitor.

- 2) Loosen the zoom lever and move the screw between T (Tele) and W (Wide) to obtain the appropriate angle of view.
- 3) Tighten the zoom lock screw.
- 4) Loosen the focus lever and move the screw between F (Far) and N (Near) to obtain the optimum focus.
- 5) Tighten the focus lock screw.

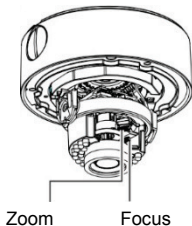

- b) TVD-2405/TVD-4405 has a motorized lens. Adjust its zoom and focus by using the zoom and focus buttons on the PTZ panel of a connected recorder or TVS-C200 controller.

Operating temperature range

The operating temperature of the TVD-2402/4402 and TVD-2404/4404 cameras is -30 to +60 °C (-22 to +140 °F).

When the camera initially starts up, the heater will start to work automatically when the temperature is below -10 °C (14 °F). However, with continuous operation the heater will not work until the internal temperature drops below -30°C (-22 °F). It will then be disabled when the temperature reaches -10 °C (14 °F). The heater only works under 24 VAC.

Program

Once the camera hardware has been installed, you can then program the camera.

The camera has a built-in OSD button and supports UtC (Up-to-Coax) control over both CVBS and TVI outputs.

Using the camera buttons

Please press the **Menu** button to call up the OSD menu and select an OSD item.

Press the button up/down to move the cursor up or down to an OSD item.

Press the button left/right to move cursor left or right to adjust the value of a selected OSD item.

Using a TVI output

Once the camera hardware has been installed, you can configure the camera settings on the TVI DVR.

Connect the TVI cable to the DVR, as shown below.

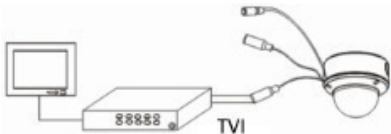

Access the PTZ menu of the connected DVR, set the TruVision-Coax protocol and use the PTZ control panel to configure the camera.

Click **Iris+** to access to the camera OSD menu and select an OSD item.

Click the directional buttons UP or DOWN to move the cursor up or down to an OSD item.

Click the directional buttons LEFT or RIGHT to move cursor left or right to adjust the value of a selected OSD item.

Note: The TVD-2405/TVD-4405 camera has a motorized lens. Use the ZOOM and FOCUS buttons to adjust its zoom and focus.

For more details, refer to the TVI DVR user manual.

Using a CVBS output

A TVS-C200 (purchase separately) can be used to program the camera over its CVBS output, not the TVI video output.

Connect a monitor and the TVS-C200 controller (if required) as shown below.

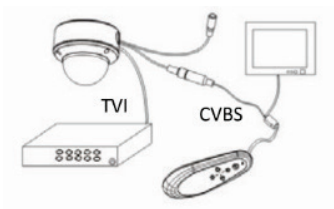

Press the **OK** button of the TVS-C200 for a few seconds until you see the OSD menu display on the monitor. The **OK** button is also used to select an OSD item.

Use the directional buttons to move the cursor and change a value.

For more details, refer to the TVS-C200 user manual.

TVD-2402/TVD-4402

The camera has CVBS and TVI dual video outputs. Set the built-in switch to **CVBS** for viewing the program on a standard monitor.

The TVI signal is blocked until the camera configuration is complete and the switch is reset to TVI.

TVD-2404/TVD-4404 and TVD-2405/TVD-4405

The camera has the CVBS and TVI dual video outputs. The built-in switch is for WDR/CVBS selection. Set the built-in switch to CVBS to view the setup menu on a standard monitor.

When the programming is finished, you can change the switch setting to WDR to enable the WDR feature. In such case, the CVBS output will be disabled.

If the switch is set to CVBS, the WDR feature is disabled and the camera has the both CVBS and TVI output available.

Setup menu

TVD-2402/TVD-4402:

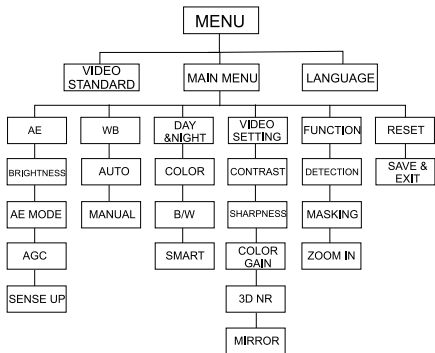

TVD-2404/TVD-4404, TVD-2405/TVD-4405:

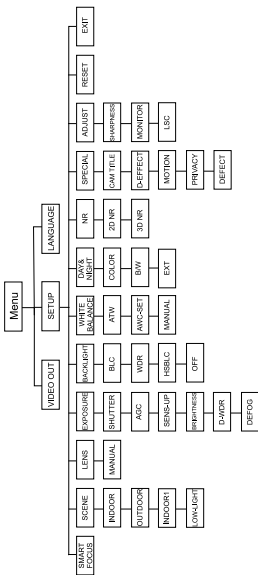

Specifications

Power supply	24 VAC/12 VDC
Current	TVD-2402/ TVD-4402: 12 VDC: 300 mA max. 24 VAC: 210 mA max. TVD-2404/TVD-4404: 12 VDC: 375 mA max. 24 VAC: 270 mA max. TVD-2405/TVD-4405: 12 VDC: 1 A max. 24 VAC: 500 mA max.
Power consumption	TVD-2402/ TVD-4402: 12 VDC: 3.5W max. 24 VAC: 5 W max. TVD-2404/TVD-4404: 12 VDC: 4.5 W max. 24 VAC: 6.5 W max. TVD-2405/TVD-4405: 12 VDC: 12 W max. 24 VAC: 12 W max.
Weight (net)	641 g / 1.41 lb. (without back box) 932 g / 205 lb. (with back box)

Dimensions	Ø145.3 x 124.2 mm (Ø 5.72 x 4.89 in.)
------------	---

Legal and Regulatory information

Copyright:

© 2016 United Technologies Corporation,
Interlogix is part of UTC Climate, Controls & Security, a unit of
United Technologies Corporation. All rights reserved.

Trademarks and patents:

Trade names used in this document may be trademarks or registered trademarks of the manufacturers or vendors of the respective products.

Manufacturer:

Interlogix

2955 Red Hill Avenue, Costa Mesa, CA 92626-5923, USA

Authorized EU manufacturing representative:

UTC Fire & Security B.V.

Kelvinstraat 7, 6003 DH Weert, The Netherlands

Certification:



FCC compliance: Class A

Class A: This equipment has been tested and found to comply with the limits for a Class A digital device, pursuant to part 15 of the FCC Rules. These limits are designed to provide reasonable protection against harmful interference when the equipment is operated in a commercial environment. This equipment generates, uses, and can radiate radio frequency energy and, if not installed and used in accordance with the instruction manual, may cause

harmful interference to radio communications. Operation of this equipment in a residential area is likely to cause harmful interference in which case the user will be required to correct the interference at his own expense.

ACMA compliance

Notice! This is a Class A product. In a domestic environment this product may cause radio interference in which case the user may be required to take adequate measures.

Canada

This Class A digital apparatus complies with Canadian ICES-003. Cet appareil numérique de la classe A est conforme à la norme NMB-0330 du Canada.

European Union directives:

12004/108/CE (EMC directive): Hereby, UTC Fire & Security declares that this device is in compliance with the essential requirements and other relevant provisions of Directive 2004/108/EC.



2012/19/EU (WEEE directive): Products marked with this symbol cannot be disposed of as unsorted municipal waste in the European Union. For proper recycling, return this product to your local supplier upon the purchase of equivalent new equipment, or dispose of it at designated collection points. For more information see: www.recyclethis.info.

Contact information:

For contact information, see www.interlogix.com or www.utcssecurityproducts.eu

