







TruVision NVR 50 User Manual

Copyright	© 2013 UTC Fire & Security Americas Corporation, Inc. Interlogix is part of UTC Climate Controls & Security, a unit of United Technologies Corporation. All rights reserved.
Trademarks and patents	The TruVision NVR 50 and logo are trademarks of United Technologies. Other trade names used in this document may be trademarks or registered trademarks of the manufacturers or vendors of the respective products.
Manufacturer	UTC Fire & Security Americas Corporation, Inc. 2955 Red Hill Avenue, Costa Mesa, CA 92626-5923, USA Authorized EU manufacturing representative: UTC Fire & Security B.V. Kelvinstraat 7, 6003 DH Weert, The Netherlands
Certification	  N4131
FCC compliance	This device complies with part 15 of the FCC Rules. Operation is subject to the following two conditions: (1) This device may not cause harmful interference, and (2) this device must accept any interference received, including interference that may cause undesired operation.
FCC compliance	Class B: This equipment has been tested and found to comply with the limits for a Class B digital device, pursuant to part 15 of the FCC Rules. These limits are designed to provide reasonable protection against harmful interference in a residential installation. This equipment generates, uses, and can radiate radio frequency energy and, if not installed and used in accordance with the instructions, may cause harmful interference to radio communications. There is no guarantee that interference will not occur in a particular installation. If this equipment does cause harmful interference to radio or television reception, which can be determined by turning the equipment off and on, the user is encouraged to try to correct the interference by one or more of the following measures: <ul style="list-style-type: none"> • Reorient or relocate the receiving antenna. • Increase the separation between the equipment and receiver. • Connect the equipment into an outlet on a circuit different from that to which the receiver is connected. • Consult the dealer or an experienced radio/TV technician for help.
ACMA compliance	Notice! This is a Class A product. In a domestic environment this product may cause radio interference in which case the user may be required to take adequate measures.
European Union directives	12004/108/EC (EMC directive): Hereby, UTC Fire & Security declares that this device is in compliance or with the essential requirements and other relevant provisions of Directive 2004/108/EC.
 	2002/96/EC (WEEE directive): Products marked with this symbol cannot be disposed of as unsorted municipal waste in the European Union. For proper recycling, return this product to your local supplier upon the purchase of equivalent new equipment, or dispose of it at designated collection points. For more information see: www.recyclethis.info .
	2006/66/EC (battery directive): This product contains a battery that cannot be disposed of as unsorted municipal waste in the European Union. See the product documentation for specific battery information. The battery is marked with this symbol, which may include lettering to indicate cadmium (Cd), lead (Pb), or mercury (Hg). For proper recycling, return the battery to your supplier or to a designated collection point. For more information see: www.recyclethis.info .
Contact information	For contact information, see www.utcfireandsecurity.com or www.utcssecurityproducts.eu .

Content

Chapter 1	Product introduction 1
	Product overview 1
Chapter 2	Installation 3
	Installation environment 3
	Unpacking the TVN 50 and its accessories 3
	Back panel 4
	Wiring the keypad 5
	RS-485 ports 8
	RS-232 port 8
	Monitor connections 8
	Audio inputs and output 8
	Brackets 9
Chapter 3	Getting started 11
	Turning on and off the NVR 11
	Using the setup wizard 12
Chapter 4	Operating instructions 17
	Controlling the TVN 50 17
	Using the front panel 17
	Using the mouse 19
	Using the IR remote control 20
	Menu overview 23
Chapter 5	Live view 27
	Description of live view 27
	Video output 27
	Audio output 28
	Controlling live view mode 28
	Multiview format 30
	Sequencing cameras 31
	Accessing frequently used commands 31
	Configuring live view 33
	General settings 36
	Configuring time and date 38
Chapter 6	Controlling a PTZ camera 41
	Calling up presets, tours and shadow tours 41
	Setting and calling up presets 42
	Setting and calling up preset tours 44
	Setting and calling up a shadow tour 46

Chapter 7	Playing back a recording 49
	Overview of the playback window 49
	Playback pop-up menu 51
	Instant playback 52
	All-day playback 53
	Searching recorded video 54
	Playing back recordings by time and video type 55
	Playing back recordings by event 56
	Creating and playing back bookmarked recordings 57
	Slideshow of snapshots 58
	Playing back recordings from the system log 59
	Playing back frame-by-frame 60
	Digital zoom in playback 60
Chapter 8	Archiving recorded files 61
	Archiving files 61
	Creating and archiving video clips 64
	Archiving snapshots 64
	Managing backup devices 65
	Playing back archived files on a PC 65
Chapter 9	Using the web browser 67
	Windows Vista and 7 users 67
	Accessing the web browser 68
	Web browser overview 68
	Using the web browser to configure the device 70
	Searching and playing back recorded video 73
	Searching for event logs 75
	Controlling a PTZ dome camera in the web browser 75
	Capturing text insertions 76
	Text overlay 78
	Using a network storage system 78
Chapter 10	Recording 81
	Initializing recording settings 81
	Defining a recording schedule 84
	Daily schedules 85
	Holiday schedules 86
	Motion detection schedules 87
	External alarm schedules 87
	Protecting recorded files 87
	Configuring redundant recording 89
	Capturing text insertions 90
Chapter 11	Alarm settings 91
	Description of alarm notification types 91
	Setting up motion detection 92
	Setting up external alarms 94

	Triggering or clearing alarm outputs manually	96
	Setting up system notifications	96
	Detecting video loss	97
	Detecting video tampering	98
Chapter 12	Network settings	99
	Configuring general network settings	99
	Configuring PPPoE	101
	Configuring DDNS	101
	Configuring an NTP server	102
	Configuring e-mail	103
	Configuring SNMP	103
	Configuring the FTP server	104
	Configuring a remote alarm host	104
	Configuring multicast	104
	Configuring the server and HTTP ports	105
	Configuring the RTSP service port	105
	Checking network status	105
	Exporting network packet data	106
	Port forwarding	107
Chapter 13	HDD management	109
	Initializing HDDs	109
	Controlling disk space on the HDD	109
	Setting up HDD groups	110
	Setting the HDD property	111
	Checking HDD status	111
	Configuring HDD alarms	112
	Managing eSATA	112
	Checking the S.M.A.R.T. information	112
Chapter 14	Camera settings	115
	Adding/removing IP cameras	115
	Configuring the camera OSD settings	117
	Setting up privacy masking	118
	Adjusting camera image settings	118
Chapter 15	NVR management	121
	Configuring the RS-232 port	121
	Updating system firmware	122
	Restoring default settings	123
	Viewing system information	123
	Searching system logs for events	125
Chapter 16	User management	127
	Adding a new user	127
	Customizing a user's access privileges	128
	Deleting a user	130

	Modifying a user	130
	Changing the Admin password	130
Chapter 17	iTVRmobile	131
	Setup and login	131
	Live view	132
	Controlling a PTZ camera	133
	Device management	135
	Favorites	136
	Local configuration	136
	Change passwords	136
	Snapshots	136
Appendix A	Specifications	137
Appendix B	PTZ protocols	139
Appendix C	Port forwarding information	141
Appendix D	KTD-405 keypad	143
	Supported firmware	143
	Wiring the keypad	143
	Setting up the keypad to work with the TVN 50	144
	Operating the keypad	146
Appendix E	Maximum pre-recording times	151
Appendix F	Supported PTZ commands	153
Appendix G	Default menu settings	155
	Glossary	165
	Index	167

Chapter 1

Product introduction

Product overview

This is the TruVision NVR 50 (TVN 50) User Manual for models:

Table 1: Product codes

TVN-5032-4T	TruVision TVN 50, 32 channels, 4 TB storage, North American power cord
TVN-5032-8T	TruVision TVN 50, 32 channels, 8 TB storage, North American power cord
TVN-5032-12T	TruVision TVN 50, 32 channels, 12 TB storage, North American power cord
TVN-5032-16T	TruVision TVN 50, 32 channels, 16 TB storage, North American power cord
TVN-5032-2TEA	TruVision TVN 50, 32 channels, 2 TB storage, EU + UK power cords
TVN-5032-4TEA	TruVision TVN 50, 32 channels, 4 TB storage, EU + UK power cords
TVN-5032-8TEA	TruVision TVN 50, 32 channels, 8 TB storage, EU + UK power cords
TVN-5032-12TEA	TruVision TVN 50, 32 channels, 12 TB storage, EU + UK power cords
TVN-5032-16TEA	TruVision TVN 50, 32 channels, 16 TB storage, EU + UK power cords
TVN-5032-4TAZ	TruVision TVN 50, 32 channels, 4 TB storage, ANZ power cords

The TruVision™ NVR 50 is a versatile, user-friendly embedded network video recorder (NVR) allowing end-users to record up to 32 cameras with a maximum total input bandwidth of 80Mbps, while providing integration with the UTC portfolio of security solutions, and offering a seamless product experience within the TruVision brand.

Its dual streaming functionality allows the user to set up different settings for recording and streaming video in live view mode.

The TruVision NVR 50 can fully integrate with the license-free TruVision Navigator software, which is ideal for most commercial applications. TVN 50's easy and intuitive-to-use web browser interface enables remote configuration and secure viewing, searching, and playing back of video from computers connected via the Internet.

Chapter 2

Installation

This section describes how to install the TVN 50 unit.

Installation environment

When installing your product, consider these factors:

- Ventilation
- Temperature
- Moisture
- Chassis load

Ventilation: Do not block any ventilation openings. Install in accordance with the manufacturer's instructions. Ensure that the location planned for the installation of the unit is well ventilated.

Temperature: Consider the unit's operating temperature (-10 to +55 °C, 14 to 131 °F) and noncondensing humidity specifications (10 to 90%) before choosing an installation location. Extremes of heat or cold beyond the specified operating temperature limits may reduce the life expectancy of the NVR. Do not install the unit on top of other hot equipment. Leave 44 mm (1.75 in.) of space between rack-mounted TruVision NVR 50 units.

Moisture: Do not use the unit near water. Moisture can damage the internal components. To reduce the risk of fire or electric shock, do not expose this unit to rain or moisture.

Chassis: Equipment weighing less than 15.9 kg (35 lb.) may be placed on top of the unit.

Unpacking the TVN 50 and its accessories

When you receive the product, check the package and contents for damage, and verify that all items are included. There is an item list included in the package. If any of the items are damaged or missing, please contact your local supplier.

Items shipped with the product include:

- IR (infrared) remote control
- Two AAA batteries for the remote control
- AC power cords
- USB mouse
- NVR
- CD with software and manuals
- *TruVision NVR 50 Quick Start Guide*
- *TruVision NVR 50 User Manual (on CD)*

Back panel

Figure 1 on page 5 shows the back panel connections and describes each connector on a typical TVN 50 network video recorder. Details may vary for specific models.

Before powering up the NVR, connect a main monitor for basic operation.

Figure 1: Back panel connections

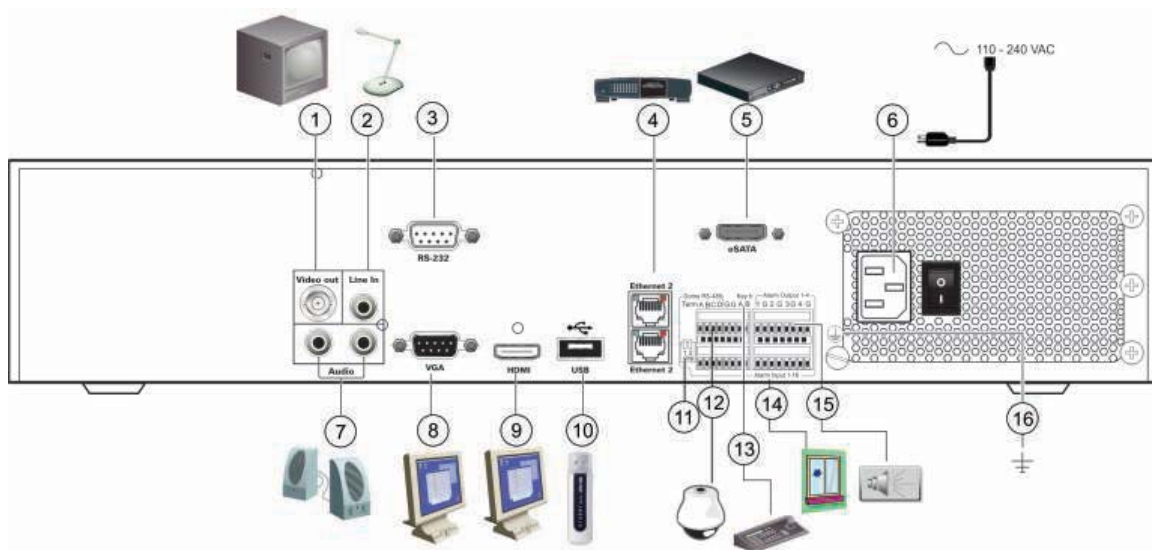

1. Connect one CCTV monitor (BNC-type connectors): Main monitor.
2. Connect one audio input to RCA connectors.
3. Connect to a RS-232 device.
4. Connect to a network.
5. Connect to an optional eSATA device such as SATA HDD, CD/DVD-RM.
6. Connect to a power cord.
7. Connect to speakers for audio output.
8. Connect to a VGA monitor.
9. Connect to an HDTV. The HDMI connection supports both digital audio and video.
10. Connect to an optional USB device such as a mouse, CD/DVD burner or HDD.
11. Terminate the line to the dome cameras using this RS-485 switch. Default is Off.
12. Connect to a PTZ control.
13. Connect to a keyboard (KTD-405 shown).
14. Connect up to 16 alarm input cables to relay outputs.
15. Connect up to four alarm relay outputs.
16. Connect to ground.

Wiring the keypad

The keypad uses RS-485 simplex wiring. The signal is transferred by a single twisted pair line. A shielded STP CAT5 network cable is recommended. Ground one end of the cable, either the first or last device on the RS-485 line.

The maximum number of devices that can be installed in one bus is 255, with a maximum cable length of 1200 m. The cable length can be expanded using a signal distributor.

Both the first and the last device in series should be terminated with 120 Ohm resistance to minimize line reflections. See Figure 2 below.

Figure 2: RS-485 bus serial wiring (KTD-405 keypad shown)

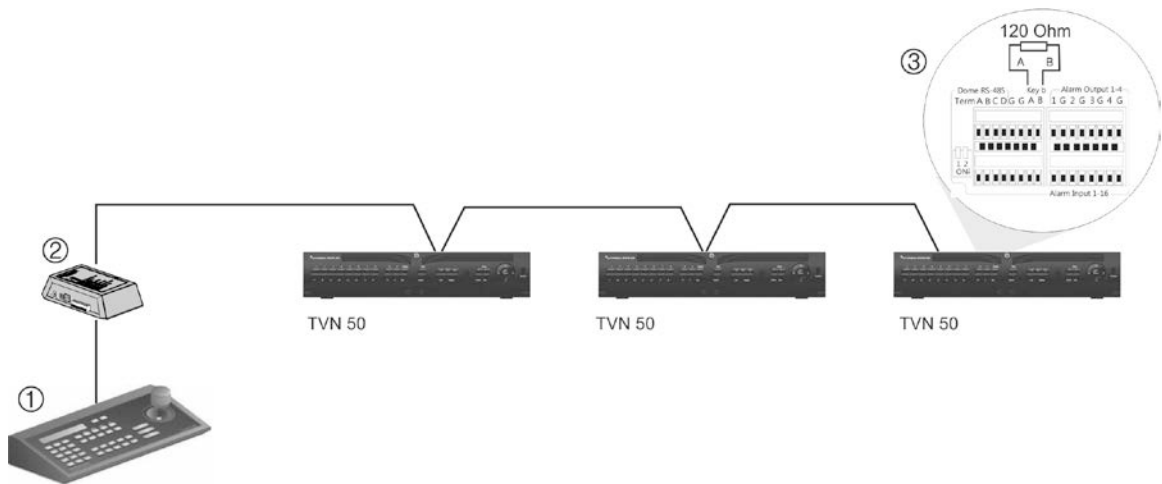

- 1. Keypad
- 2. I/O box

3. See section "RS-485 ports" on page 8

Use an RS-485 signal distributor for a star wiring configuration. See Figure 3 on page 6.

Figure 3: Star wiring with RS-485 signal distributor

Correct:

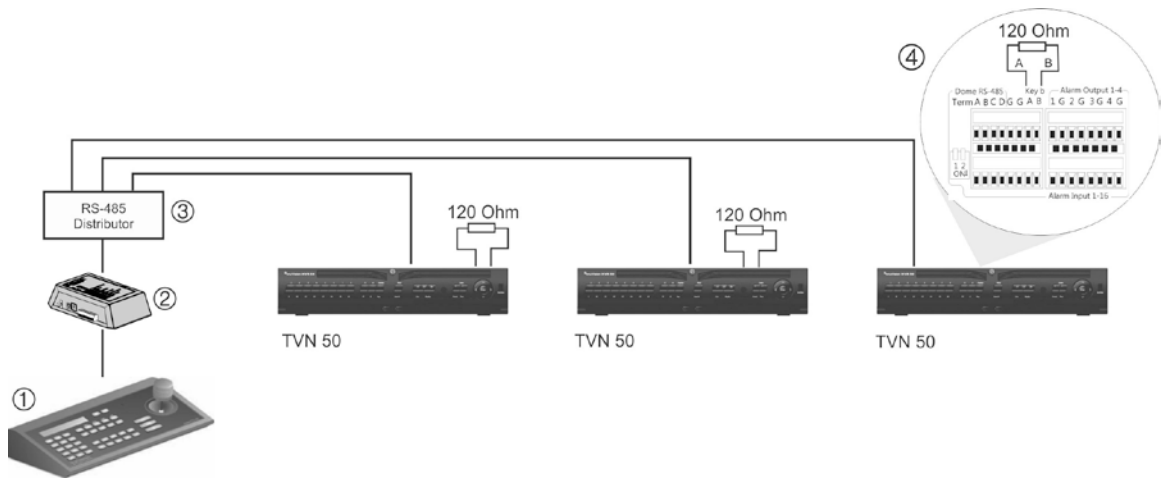

- 1. Keypad
- 2. I/O box

3. RS-485 distributor
4. See section "RS-485 ports" on page 8

Incorrect:

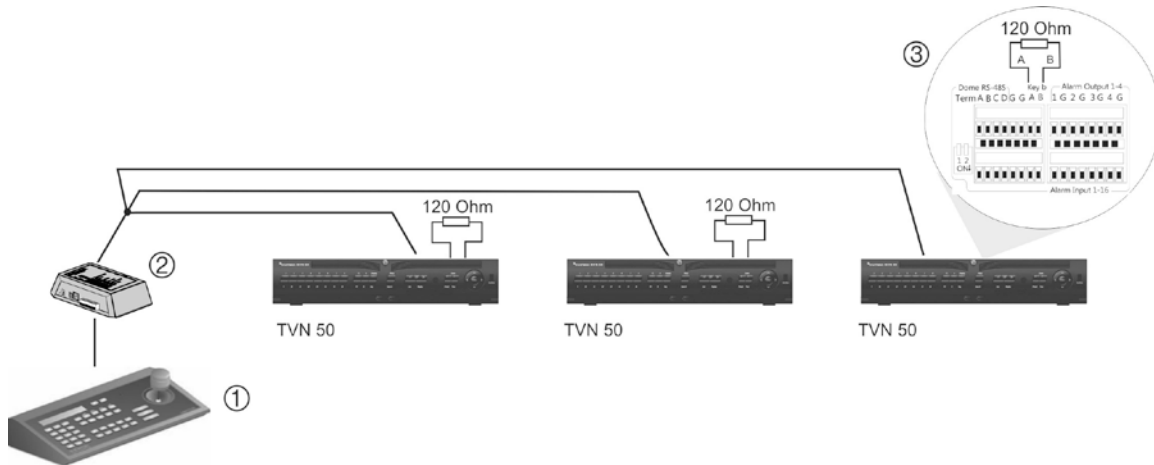

- 1. Keypad
- 2. I/O box

3. See section “RS-485 ports” on page 8

Use an RS-485 signal distributor to increase the maximum number of devices on the bus as well as the total range. Each distributor output provides another RS-485 bus, extending the output an additional 1200 m. Up to 31 NVRs can be connected to each output. See Figure 4 below.

Figure 4: Expanding the system with an RS-485 signal distributor

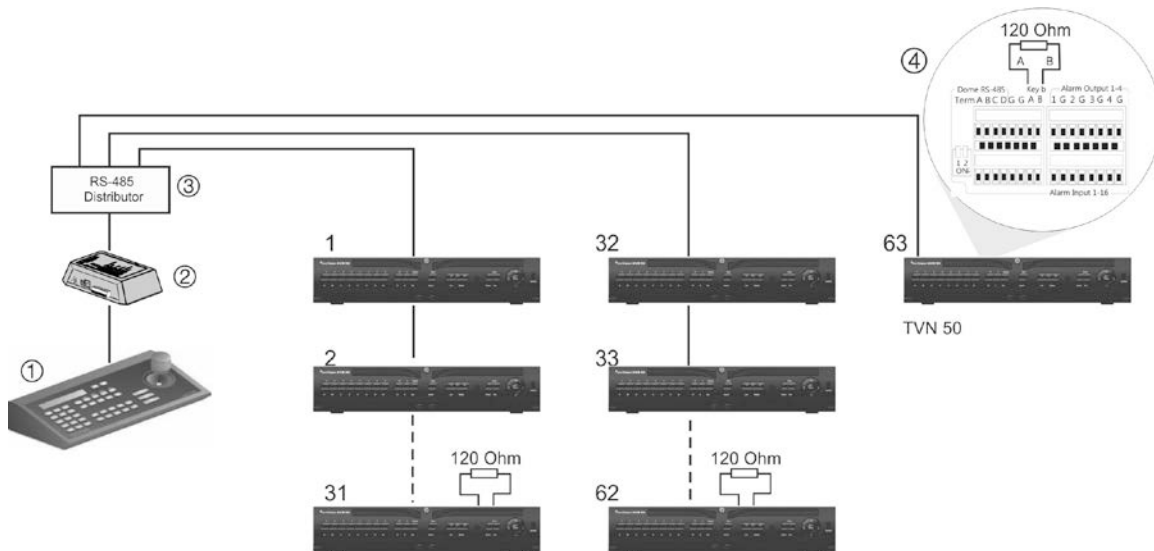

- 1. Keypad
- 2. I/O box

3. RS-485 distributor
4. See section “RS-485 ports” on page 8

Caution: Most signal distributors are unidirectional. This means that the signal only flows from the input towards the outputs. Consequently it is not possible to connect several keypads.

See section “RS-485 ports” below to configure the RS-485 port communication settings.

RS-485 ports

There are two RS-485 ports on the rear panel of the NVR. See Figure 5 below for the serial pin outs.

- **Dome RS-485:**

A and B: Connect pan, tilt, zoom control of PTZ dome cameras. A = +, B = -

C and D: Not used

G: Ground of dome camera

G: Ground of keypad

- **Keyb:** Connect the keypad.

Figure 5: RS-485 pins

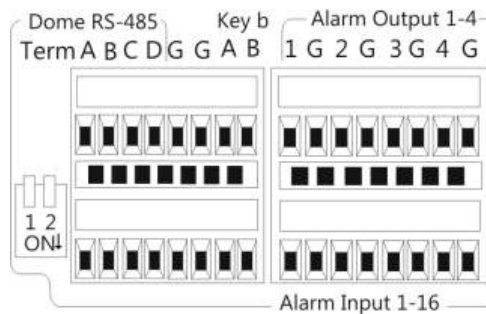

RS-232 port

Use the RS-232 port to connect CBR-PB3-POS (point-of-sale) and ATM devices to the NVR.

Monitor connections

Connect the unit to a monitor via a 75-ohm video coaxial cable with the BNC connector. The unit provides a 1 Vp-p CVBS signal. See Figure 1 on page 5 for connecting a monitor to a TVN 50.

The TVN 50 supports up to 1920 × 1080 / 60 Hz resolution in VGA. The monitor resolution should be at least 800 × 600. Adjust your monitor accordingly to this resolution.

Audio inputs and output

The unit is equipped with 1 audio input and two audio outputs. Both the audio outputs and the audio inputs are line-level.

Audio input	RCA jack, 315 mV, 40 kohms. Unbalanced
Audio output	RCA jack, 315mV, 600 ohms. Unbalanced

Note: Line-level audio requires amplification.

Brackets

The NVR is easily rack-mountable with the purchase of the TVR-RK-1 rack-mount kit. See Figure 6 below. Contact your local supplier to order it.

Figure 6: Rack-mount installation

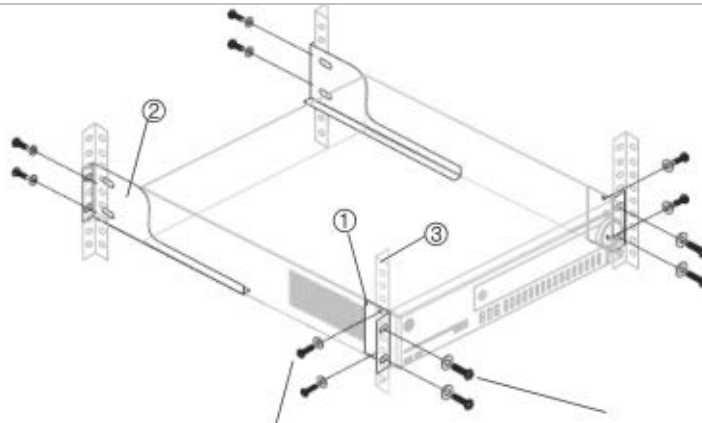

Attach the small front rack ears to the unit
(screws supplied)

Attach the NVR to the front rails
(screws not included)

To install the racks:

1. Attach the two small front-rack mount ears to the NVR (screws supplied).
2. Attach the two large rear support brackets (not supplied) to the rear rails.
3. Attach the NVR to the front rails (screws not supplied).

Caution:

Do not rack-mount the TVN 50 without the rear rails installed. Failure to install the rear rails can damage the NVR.

Chapter 3

Getting started

Turning on and off the NVR

Before starting the power up process, connect at least one monitor to the video out or the VGA interface. Otherwise, you will not be able to see the user interface and operate the device.

The TVN 50 auto-detects the video mode (PAL or NTSC) on startup.

It is equipped with a universal power supply that will auto-sense 110/240 V, 60/50 Hz.

Note: It is recommended that an uninterruptible power supply (UPS) is used in conjunction with the device.

To turn on the NVR:

Turn on the NVR using the power switch on the back panel. The power LED illuminates. A splash screen appears indicating that the NVR is starting up.

The Start Up Wizard window will appear.

To turn off the NVR:

1. In live view mode, right-click the mouse and click **Menu**. The main menu screen appears.
2. Select the **Power Manager** icon.
3. In the Shutdown popup menu, select **Shutdown**. Click **Yes** to confirm shutdown.

To reboot the NVR:

1. In live view mode, right-click the mouse and click **Menu**. The main menu screen appears.
2. Select the **Power Manager** icon.
3. In the Shutdown popup menu, select **Reboot**. Click **Yes** to confirm shutdown.

Using the setup wizard

The TVN 50 has an express installation wizard that lets you easily configure basic NVR settings when first used. It configures all cameras simultaneously. The configuration can then be customized as required.

By default the setup wizard will start once the NVR has loaded. It will walk you through some of the more important settings of your NVR.

Any changes you make to a setup configuration page are saved when you exit the page and return to the main wizard page.

Note: If you want to set up the NVR with default settings only, click Next in each screen until the end.

To quickly set up the TVN 50:

1. Connect all the devices required to the back panel of the NVR. See Figure 1 on page 5.
2. Turn on the unit using the power switch on the back panel.
3. Select the preferred language for the system from the dropdown list and then click **Next**.
4. Enable or disable the option to start the wizard automatically when the NVR is turned on. Click **Next**.

5. Administrator configuration:

Navigate to the Admin Password edit box and click the edit box with the mouse, or press Enter on the front panel or remote control, to display the virtual keyboard. Enter the default admin password, 1234.

Note: You must enter an admin password. To change the Admin password, check **New Admin password** and enter the new password and confirm it.

Caution: It is strongly recommended that you change the password of the administrator. Do not leave 1234 as the default password. Write it down in a safe place so that you do not forget it.

If you should forget the password to your NVR, contact your supplier with the serial number of your NVR to obtain a secure code to reset your NVR.

If you wish to limit the admin rights to only one computer, enter the MAC address of the user's computer. Otherwise leave the MAC address unchanged.

Click **Next**.

6. Time and date configuration:

Select the desired time zone, date format, system time and system date.

Note: Daylight savings time (DST) cannot be configured from the Wizard. See "Configuring time and date" on page 38 for more information on DST.

Wizard	
Time Zone	(GMT-08:00) Pacific Time(U.S. & Canada) ▾
Date Format	MM-DD-YYYY ▾
System Date	09-28-2012 📅
System Time	14:05:01 🕒
Apply	
Previous Next Cancel	

Note: The system time and date are visible on screen. However, they do not appear in recordings.

Click **Next** to move to the next page, or **Previous** to return to the previous page.

7. Network configuration:

Configure your network settings such as the NIC type, Enable or Disable DNCP, IP address, subnet mask and default gateway. Enter the preferred DNS server address as well as the alternate one to use.

Wizard	
Working Mode	Load Balance ▾
Select NIC	bond0
NIC Type	10M/100M/1000M Self-adaptive
Enable DHCP	<input type="checkbox"/>
IPv4 Address	172 .5 .1 .90
IPv4 Subnet Mask	255 .255 .255 .0
IPv4 Default Gateway	172 .5 .1 .1
Preferred DNS Server	
Alternate DNS Server	
Previous Next Cancel	

Click **Next** to move to the next page, or **Previous** to return to the previous page.

8. HDD management:

Configure your HDD settings as required.

You can group HDDs and assign cameras to a group. See “Setting up HDD groups” on page 110 for further information. You can also set up a drive for redundant recording. See “Configuring redundant recording” on page 89.

After configuring your HDD settings, click **Initialize** and **Next** to move to the next page, or **Previous** to return to the previous page.

9. Adding IP Camera:

Click **Search** to find any online cameras. Select the IP camera to be added, enter User name and Admin password, then click the **Add** button. Click, **Next** to move to the Recording Configuration screen.

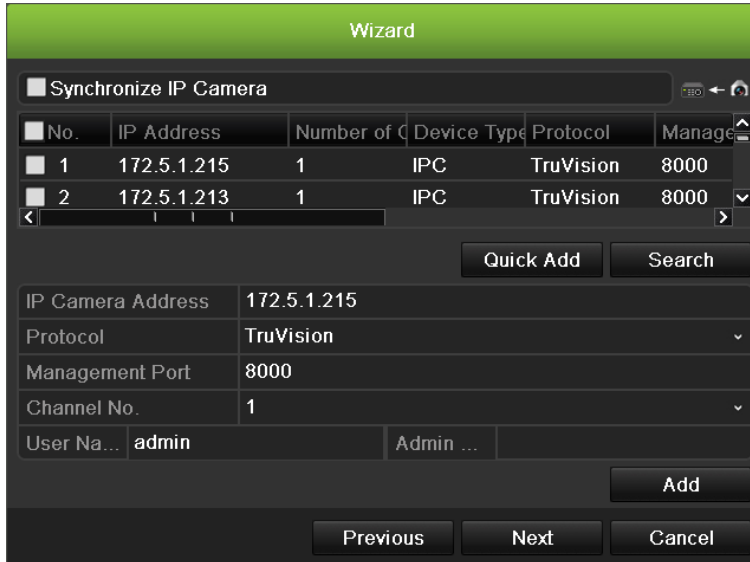

10. Recording configuration:

Configure your recording settings as required. The settings apply to all cameras connected to the NVR.

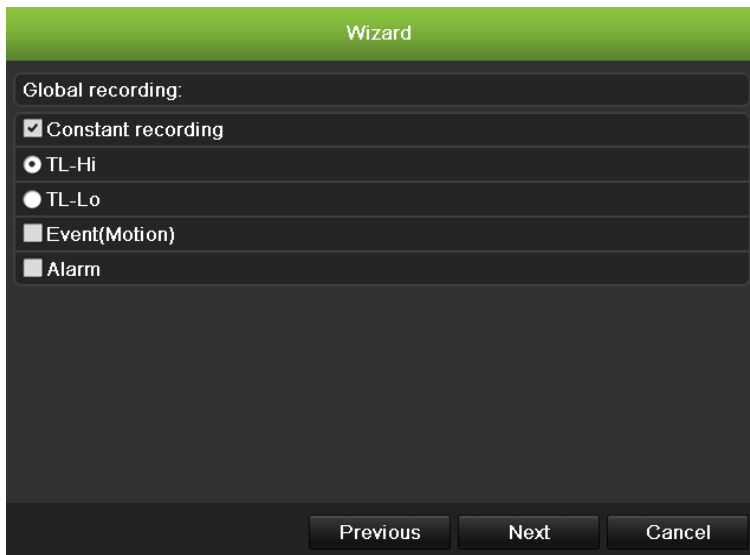

Check the **Constant Recording** checkbox for the NVR to record continuously all day. If left unchecked, the NVR will not record.

Check the desired time lapse check box, TL-Hi or TL-Lo.

To record motion detection events, check **Event (Motion)**.

To record alarm events, check **Alarm**.

11. When all the required changes have been entered, a page appears showing all the settings.

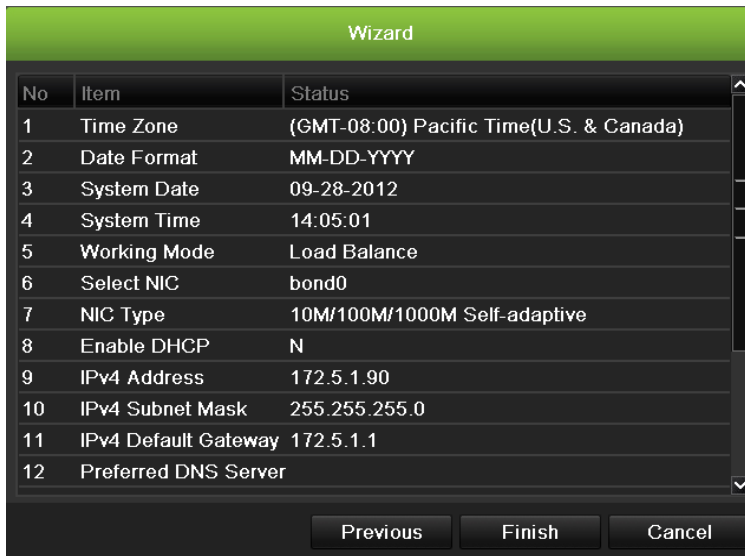

The screenshot shows a 'Wizard' window with a table of configuration items. The table has three columns: 'No', 'Item', and 'Status'. Below the table are three buttons: 'Previous', 'Finish', and 'Cancel'.

No	Item	Status
1	Time Zone	(GMT-08:00) Pacific Time(U.S. & Canada)
2	Date Format	MM-DD-YYYY
3	System Date	09-28-2012
4	System Time	14:05:01
5	Working Mode	Load Balance
6	Select NIC	bond0
7	NIC Type	10M/100M/1000M Self-adaptive
8	Enable DHCP	N
9	IPv4 Address	172.5.1.90
10	IPv4 Subnet Mask	255.255.255.0
11	IPv4 Default Gateway	172.5.1.1
12	Preferred DNS Server	

Previous Finish Cancel

Click **Finish** to exit the Wizard. The NVR is now ready to use.

Chapter 4

Operating instructions

Controlling the TVN 50

There are several ways to control the NVR:

- Front panel control
- Mouse control
- IR remote control
- KTD-405 keypad control (see Appendix)
- Web browser control

You can use your preferred control method for any procedure, but in most cases we describe procedures using mouse terminology. Optional control methods are given only when they differ substantially from mouse control methods.

Using the front panel

The function buttons on the front panel control can be used to operate many, but not all, of the main functions of the NVR. The LED indicators light up or flash to alert you of various conditions. The functions available can be limited by setting passwords. See Figure 7 below for more information.

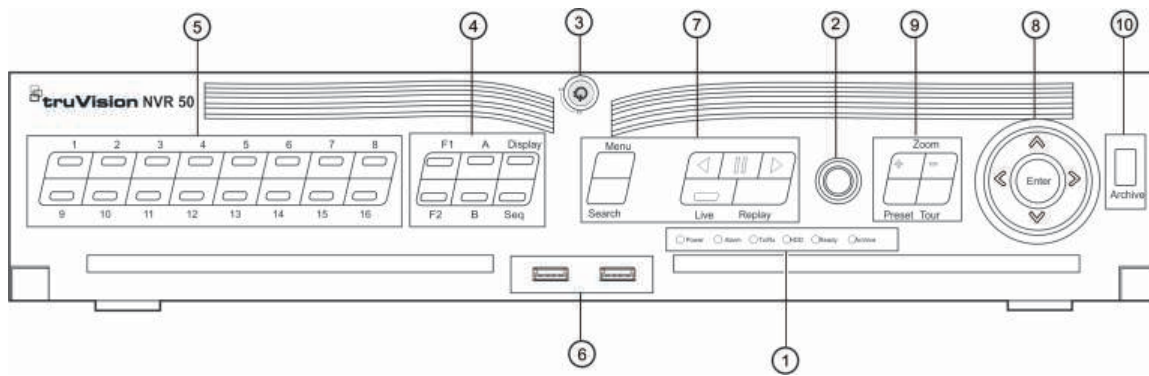

Figure 7: Front panel



The controls on the front panel include:

Table 2: Front Panel Elements

Item	Name	Description
1.	Status LEDs	<p>Power: Green indicates the NVR is working correctly. Red indicates a fault.</p> <p>Alarm: Red indicates there is an Alarm In or other alarms such as motion detection or tampering.</p> <p>Tx/Rx: Green indicates normal network connection.</p> <p>HDD: HDD indicator blinks red when data is being read from or written to the HDD.</p> <p>Ready: Green indicates the device is functioning properly.</p> <p>Archive: Archive indicator blinks green when record files or snapshots are being exported to a USB or eSATA device.</p>
2.	IR receiver	Receiver for IR remote.
3.	Front Panel Lock	You can lock or unlock the front panel with a key.
4.	Display buttons	<p>Display: Toggles through the various multiviews: full, quad, 1+5, 1+7, 9, and 16.</p> <p>Sequence: Starts/stops sequencing in live view mode.</p> <p>A: Selects monitor VGA/A in live view mode</p> <p>B: Selects monitor A/B in live view mode</p> <p>F1: In all-day playback, click to start and stop video clipping.</p> <p>F2: In live view mode, click to display/hide the time bar. In all-day playback, click to hide/display the playback control toolbar.</p>
5.	Numeric buttons	Switch between different cameras in live, PTZ control or playback modes.
6.	USB Interfaces	Universal Serial Bus (USB) ports for additional devices such as a USB mouse and USB Hard Disk Drive (HDD).

Item	Name	Description
7.	Menu and Search buttons Playback buttons	<p>Menu: Enter/exit the main menu.</p> <p>Search: Enter the advanced search menu.</p> <p> : Jump back to the oldest available video and starts the playback.</p> <p> : Pause playback.</p> <p> : Instantly playback the currently selected file. Default time is 1 minute.</p> <p>Live: Switch to live view mode.</p> <p>Replay: Replay the current file in playback Starts at the beginning of the file.</p>
8.	Direction Enter button	<p>The DIRECTION buttons are used to navigate between different fields and items in menus.</p> <p>In the Playback mode, the left and right buttons are used to speed up and slow down recorded video. The up and down buttons are used to jump recorded video forwards or backwards by 30 s.</p> <p>In Pause mode, the left and right buttons are used to jump recorded video forwards or backwards by one frame. The up and down buttons are used to jump recorded video forwards or backwards by one second..</p> <p>In Live View mode, these buttons can be used to cycle through channels.</p> <p>In PTZ control mode, it can control the movement of the PTZ camera.</p> <p>The ENTER button is used to confirm selection in any of the menu modes.</p> <p>Show the PTZ control toolbar when in live view mode.</p> <p>In Playback mode, it can be used to play or pause the video.</p> <p>In single-frame Playback mode, pressing the button will advance the video by a single frame.</p>
9.	PTZ buttons	<p>Zoom: Use + and – for digital zoom.</p> <p>Preset: Call up preprogrammed preset positions.</p> <p>Tour: Call up preprogrammed shadow tours.</p>
10.	Archive button	Press once to enter quick archive mode. Press twice to start archiving. Indicator blinks green when data is being written to backup device.

Using the mouse

The USB mouse provided with the TVN 50 can be used to operate all the functions of the NVR, unlike the front panel which has limited functionality. The USB mouse lets you navigate and make changes to settings in the user interface.

Connect the mouse to the TVN 50 by plugging the mouse USB connector into the USB port on the front or back panel. The mouse is immediately operational and the pointer should appear.

Note: Use a USB 1.1 or higher mouse.

Move the pointer to a command, option, or button on a screen. Click the left mouse button to enter or confirm a selection.

You can purchase a spare mouse by ordering part number TVR-MOUSE-1 mouse.

See Table 3 below for a description of the mouse buttons.

Table 3: Mouse buttons

Item	Description	
Left button	Single-Click	<p>Live view: Select a camera to display the quick access toolbar (see “Accessing frequently used commands” on page 31).</p> <p>Menu: Select a component of a menu, such as a button or an input field. This is similar to pressing the Enter button on the remote/front panel controls.</p>
	Double-Click	<p>Live view: Switch between single screen and multi-screen mode in live/ playback mode.</p>
	Click and Drag	<p>Live view: Drag channel/time bar.</p> <p>PTZ control: Adjust pan, tilt and zoom.</p> <p>Tamperproof, privacy masking and motion detection functions: Select the target area.</p> <p>Digital zoom-in: Drag and select target area.</p>
Right button	Single-Click	<p>Live view: Display menu.</p> <p>Menu: Exit the current menu and return to higher level.</p>
Scroll-wheel	Scroll Up	<p>Live view: Return to the previous screen.</p> <p>Menu: Move the selection to the previous item.</p>
	Scroll Down	<p>Live view: Move to the next screen.</p> <p>Menu: Move the selection to the next item.</p>

Using the IR remote control

The TVN 50 is supplied with an infra red (IR) remote control unit. Like the mouse, it can be used to operate all of the main functions of the TVN 50.

The IR remote control can be programmed with a unique device ID address so that the controller will only be able to communicate with NVRs with that address. No programming is necessary if using a single TVN 50.

The device ID address only applies when using a remote control and not when using a keypad.

You can purchase a remote control by ordering part number TVR-REMOTE-1 remote control.

Figure 8: IR remote control

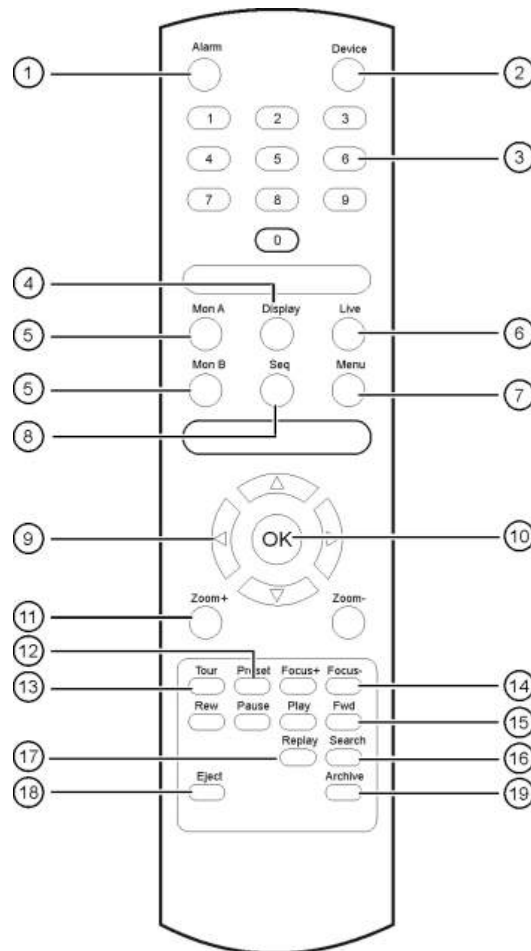

Item	Description
1. Alarm	Acknowledge an alarm.
2. Device	Enable/disable the IR remote control to control the TVN 50.
3. Numeric buttons	Select a camera, and enter a number in a menu option.
4. Display	Switch between the different multiviews.
5. Mon A and Mon B	Switch between monitors A and B.
6. Live	Return to live view mode.
7. Menu	Activate the main menu.
8. Seq	Start /stop sequencing.
9. <, >, ^, v	In Menu mode: Use left or right arrow buttons to select and up or down arrow buttons to edit entry. In PTZ mode: Use to control PTZ. In Playback mode: Use to control playback speed.
10. OK	Confirm selection.
11. Zoom + and -	Use to control zoom of camera lens.

Item	Description
12. Preset	Enter preprogrammed three-digit code to call up a preset.
13. Tour	Enter preprogrammed three-digit code to call up shadow tour.
14. Focus + and -	Use to control focus of camera lens.
15. Playback control	Use to control playback (Rewind, Pause, Play, and Fast Forward).
16. Search	Open the Search menu.
17. Replay	Replay the selected file from the beginning.
18. Eject	Eject the CD or DVD disk.
19. Archive	Press once to enter quick archive mode. Press twice to start archiving.

Aim the remote control at the IR receiver located at the front of the unit to test operation.

To connect the remote control to the TVN 50:

1. Press the **Menu** button on the front panel or right-click the mouse and select the **Menu** button. The main menu screen appears.
2. Click **Display Mode Settings > Monitor**.
3. Check the device address value. The default value is 255. This device address is valid for all IR controls.
4. On the remote control press the **Device** button.
5. Enter the device address value. It must be the same as that on the TVN 50.
6. Press **OK** on the remote control.

To place batteries into the IR remote control:

1. Remove the battery cover.
2. Insert the batteries. Make sure that the positive (+) and negative (-) poles are correctly placed.
3. Replace the battery cover.

Troubleshooting the remote control:

If the IR remote control is not functioning properly, perform the following tests:

- Check the battery polarity.
- Check the remaining charge in the batteries.
- Check that the IR remote control sensor is not masked.

If the problem still exists, please contact your administrator.

Menu overview

The TVN 50 has an icon-driven menu structure that allows you to configure the unit's parameters. Each command icon displays a screen that lets you edit a group of settings. Most menus are available only to system administrators.

The screen is divided into three sections. The currently selected command icon and submenu item are highlighted in green. See Figure 9 below.

You must be in live view mode to access the main menu.



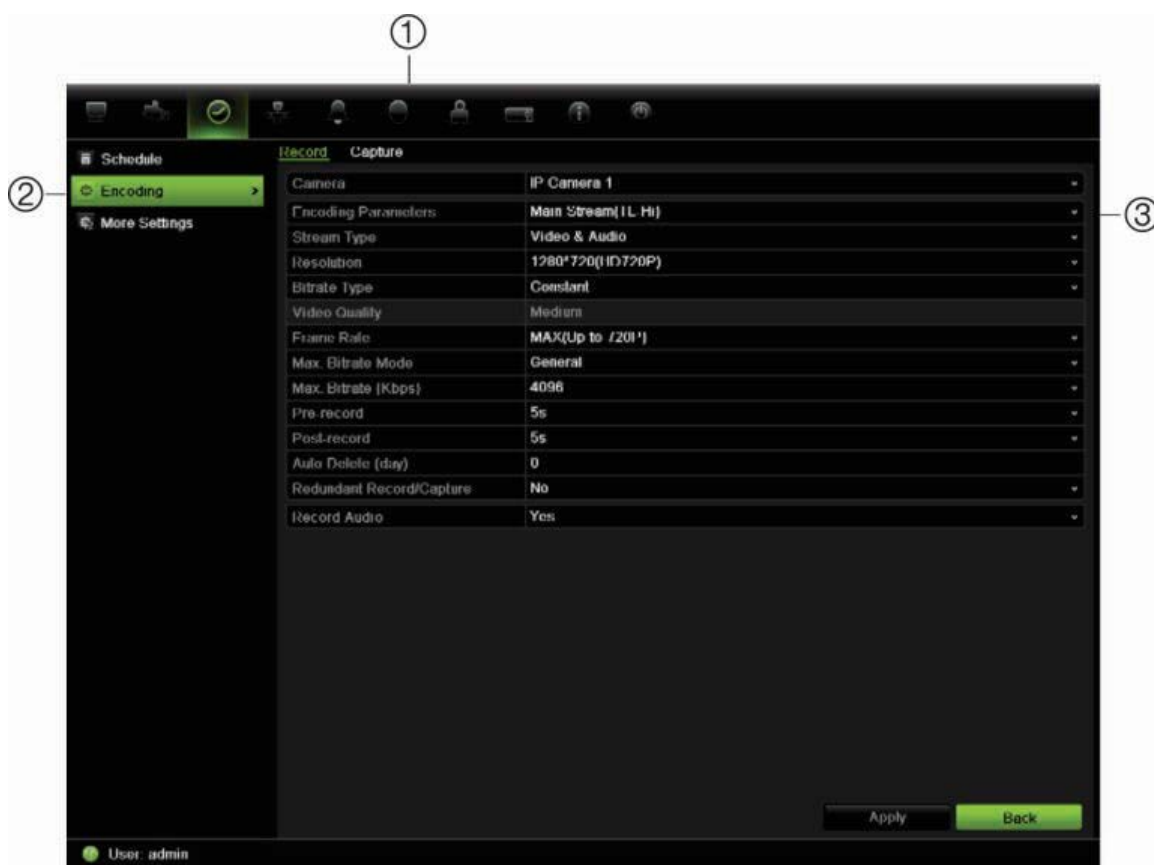





Figure 9: Menu structure



1. **Menu toolbar:** Setup options available for the selected menu function. Move the mouse over a command icon and click to select it. See Table 4 below for a description of the icons.
2. **Submenu panel:** Submenus for the selected menu function are displayed. Click an item to select it.
3. **Setup menu:** All the details for the selected submenu are displayed. Click a field to make changes.

Table 4: Description of the menu toolbar icons

Icon	Name	Description
	Display mode settings	Configures display settings including system date and time, audio output, device name, dwell time, schedule, language and display formats. See "Configuring live view" on page 33 and "Holiday schedules" on page 86.

Icon	Name	Description
	Camera management	Configures camera settings including motion detection, video image adjustments, video loss, and camera title. See Chapter 14 "Camera settings" on page 115.
	Video schedule	Configures recording settings including recording schedules, record quality, auto delete mode, and recording mode. See Chapter 10 "Recording" on page 81.
	Network settings	Configures standard network settings including IP address, e-mail notifications, DDNS setup, and advanced network settings. See Chapter 12 "Network settings" on page 99.
	Alarm settings	Configures alarm settings including alarm input, relay output, and remote alert. See Chapter 11 "Alarm settings" on page 91.
	PTZ settings	Configures PTZ settings including RS-485 settings. See Chapter 6 "Controlling a PTZ camera" on page 41.
	User management	Configures users, passwords, and access privileges. See Chapter 16 "User management" on page 127.
	System settings	Configures system settings including RS-232 settings, firmware upgrade, hard drive settings, and boot log. See Chapter 13 "HDD management" on page 109 and Chapter 15 "NVR management" on page 121.
	Help information	Provides reference information to the various toolbars, menus, and keys within the interface.
	Power manager	Provides access to logout, reboot and shutdown options. See "Turning on and off the NVR" on page 11 .

To access the main menu:

1. In live view press the **Menu** button on the remote control or front panel.
- Or -
Right-click the mouse and select **Menu** from the pop-up menu.
The main menu screen appears. The Display screen appears by default.
2. Click the required menu icon to display its submenu options. Modify the configuration parameters as required.
3. Click **Apply** to save the settings.
4. Click **Back** to return to live view.







Using the soft keyboard

A keyboard will appear on-screen when you need to enter characters in a screen option. Click a key to input that character.

Figure 10: The soft keyboard



Description of the keys in the virtual keyboard:

	Switch to lowercase/uppercase
	Space
	Exit the soft keyboard
	Alphanumeric characters
	Backspace
	Confirm selection

Exiting the main menu

Press the **Menu** button on the front panel to exit the current menu screen and return to live view or click **Back** in a main menu.

Chapter 5

Live view





Description of live view

Live view mode is the normal operating mode of the unit where you watch live images from the cameras. The TVN 50 automatically enters into live view mode once powered up. On the viewer, you can see the current date and time, camera name, and whether a recording is in progress.

Status information

Information on the system and camera status is displayed as icons on the main and spot monitors. The camera status icons are shown for each camera. Each icon represents information on a specific item. These icons include:

Table 5: Description of the on-screen status icons

Icon	Description
	Indicates a sensor alarm.
	Indicates recording (such as manual recording, motion detection or alarm-triggered recording).
	Indicates a motion detection event.
 Video Loss	Indicates a video loss event.
	Indicates alarm and system notifications. Clicking the icon opens a screen that lists the alarms and notifications.

More than one icon can be displayed at the same time.

The system status is displayed on the front panel by the status LEDs.

Video output

The TVN 50 can be connected to up to two monitors. However, only one monitor can be controlled at a time.

The NVR automatically checks the monitor outputs used. If more than one monitor is connected, the system then defines which monitor is the main one and which is the event one. The event monitor is used to display detected events such as motion. It cannot be configured separately.

The priority level for the main output is HDMI > VGA > CVBS. See Table 6 below. However, you can manually define your main monitor from the Layout menu.

Table 6: Monitor output priority level

Monitor output in use			Priority level
HDMI	VGA	CVBS	Main monitor
✓		✓	HDMI
	✓	✓	VGA
		✓	CVBS
✓	✓	✓	HDMI

To select the video output of the main monitor:

1. Click the **Display Mode Settings** icon in the menu toolbar.
2. Select **Layout > General**.
3. From Video Output Interface, select which monitor will be the main monitor: HDMI (depends on NVR model), VGA, main CVBS, or spot output. HDMI is default, if connected.

To control a monitor:

On the front panel press button A to select the main monitor. Press button B to select the event monitor.

Audio output

The HDMI monitor connector on the back panel outputs both video and audio signals. There is an audio output on the back panel for speakers.

Controlling live view mode

Many features of the live view mode can be quickly accessed by placing the cursor on a live image and clicking the right-button of the mouse. The mouse menu appears (see Figure 11 on page 29).

Figure 11: The mouse menu for the main monitor

The list of commands available depends on which monitor is active; main or spot (monitor B). See Table 7 below. The default settings of these commands are provided in Appendix G, “Default menu settings” on page 153.

Table 7: Mouse menu for monitor A (main monitor)

Item	Name	Description
1.	Menu	Enter the Main menu. This option is not available from monitor B.
2.	Single camera	Switch to a full-screen view for the selected camera from the dropdown list.
3.	Multi camera	Switch between the different multiview options from the dropdown list.
4.	Previous screen	Displays the previous camera.
5.	Next screen	Displays the next camera.
6.	Start auto-switch	Turn on sequence mode. The screen automatically sequences between cameras. See “Viewing in multiview” on page 30. Go to Menu > Display Mode Settings > Layout > Dwell Time to set up.
7.	All-day playback	Playback the recorded video of the selected day from the selected camera. The current day is selected by default. See “All-day playback” on page 53 for more information.
8.	Monitor B	Switch between monitors A (main) and B (spot).
9.	Advanced search	Enter the advanced video search menu. See “Searching recorded video” on page 54 for more information.
10.	Close timebar	Open/close the time bar.

Note: When the monitor B is active, the main monitor commands are unavailable.

Table 8: Mouse menu for monitor B (event monitor)

Item	Name	Description
1.	Single camera	Switch to a full-screen view for the selected camera from the dropdown list.
2.	Multi camera	Switch between the different multiview options from the dropdown list.
3.	Previous screen	Displays the previous camera.
4.	Next Screen	Displays the next camera.
5.	All-day playback	Playback the recorded video of the selected day from selected cameras. See “All-day playback” on page 53 for more information.
6.	Monitor A	Switch between monitors A (main) and B (spot).

Multiview format

The NVR has full screen display format as well as five multiview formats.

Viewing in full screen

Press the numeric button on the front panel to switch to the corresponding camera display. For example, press button 10 to view camera 10.

Right-click the mouse and select **Single Camera** from the menu. Select the camera required from the list.

Viewing in multiview

A video tile is any cell in a multiview display. A camera image can only be shown in one video tile at a time. The TVN 50 has five multiview display formats available as well as full screen. See Figure 12 below.

To change the multiview display that appears by default, go to the Display menu. See “Changing the camera sequence” on page 35 for more information.

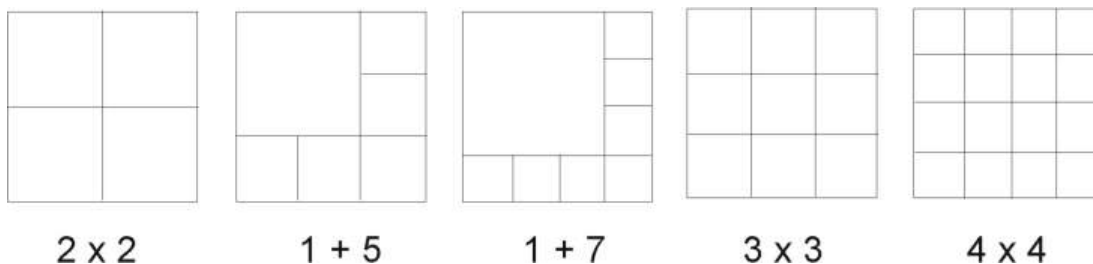
Figure 12: Multiview display formats

To select a multiview format:

1. Press the Display button on the front panel to cycle through different display formats.

You can also right-click the mouse and select **Multi Camera** from the menu. Select the desired multiview display layout.

Sequencing cameras

The sequencing feature allows a camera to be displayed briefly on screen, before advancing to the next camera in the sequence list.

The default sequence displays each camera in numerical order. However, each camera on the main and spot monitors can have a pre-programmed dwell time and sequence order. See “Changing the camera sequence” on page 35 for more information.

Note: Dwell time must not be set to zero for sequencing to function.

Sequencing live view mode using the front panel:

1. Select the camera where you want to start sequencing.
2. Press the **Seq** button on the front panel to start sequencing.
3. Press the **Seq** button again to stop the sequencing.

Sequencing live view mode using the mouse:

1. Select the camera where you want to start sequencing.
2. Right-click the mouse and select **Start auto-switch** to start the sequencing.
3. Right-click the mouse and select **Stop auto-switch** to stop the sequencing.

Accessing frequently used commands

The quick access toolbar in live view lets you quickly access regularly used commands. Position the cursor over a video image and left-click the mouse. The toolbar appears (see Figure 13 on page 32).

Figure 13: Quick access toolbar

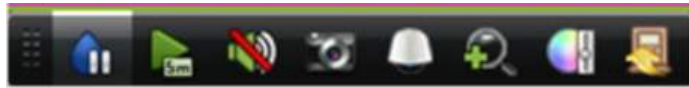









Table 9: Description of the quick access toolbar icons

Icon	Description
	Freeze: Freeze the live image of the selected camera. Although the image pauses, time and date information does not. The system clock continues to run.
	Instant playback: Playback the recorded video from the last five minutes. If no recording is found, then there was no recording made in the last five minutes. Click the icon and select the desired camera. Click OK.
	Audio: Enable/Disable audio output. The audio option must already have been setup in the Display menu.
	Quick snapshot: Capture a snapshot of a video image. The image is saved on the unit.
	PTZ control: Enter PTZ control mode.
	Digital zoom: Enter digital zoom. See "Digital zoom" below for further information.
	Image settings: Enter the image settings menu to modify the image lighting levels. There are two options: Customize: Modify brightness, contrast, saturation, and hue values. Restore: Restore image settings to previous values. These settings can also be modified from the Camera>Image menu (see page "Adjusting camera image settings" on page 118).
	Close toolbar: Close the shortcut toolbar.

Digital zoom

You can easily zoom in or out of a camera image in live view mode and playback using the digital zoom command. The zoom command magnifies the camera image four times. See Figure 14 on page 33.

Figure 14: Digital zoom screen**To quickly zoom in/out on a camera image:**

1. Select the camera you wish to use.
2. Left-click the mouse and select the digital zoom icon, or on the front panel press the **Zoom+** button. The digital view screen appears.
3. Left-click the mouse and drag the red square to the area of interest, or move the joystick on the front panel to position the red square. The selected area is magnified.
4. To exit digital zoom right-click the mouse or press the **Zoom—** button on the front panel.

Configuring live view

The setup of live view can be modified from the main menu to suit different needs, such as the different monitors, multiview layout, and dwell time options. You can also enable audio output.

Figure 15: Layout screen

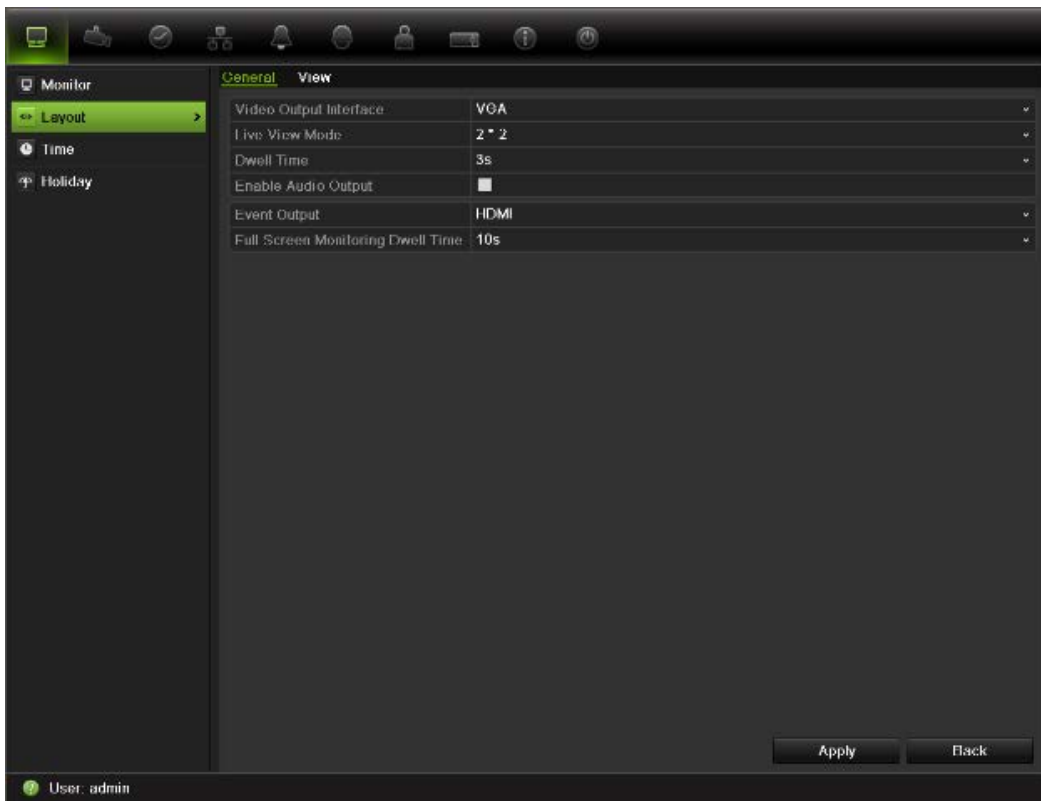

Table 10: Description of the layout screen

Submenu name	Description
General tab	
Video output interface	Select which monitor will be the main monitor: HDMI (depends on NVR model), VGA, and main CVBS. Default is VGA, if connected.
Live view mode	Select which multiview layout will be default in live view mode. Default is 4x4 multiview layout.
Dwell time	Set the length of time for which a camera image is displayed on the selected monitor before moving to the next camera during sequencing. Default is off (“No switch”).
Enable audio out	Check the box to enable/disable audio output.
Event output	Designates which monitor will be the output to show the event. Default is disable.
Full screen monitoring dwell time	Set the length of time for which an alarm event appears on the output monitor before moving to the next camera during sequencing. Default is 10 seconds.

To set up the display options:

1. Click the **Display Mode Settings** icon in the menu toolbar.
2. Select **Layout > General**.
3. Specify the desired settings for each of the menu options.

4. Click **Apply** to save the settings.
5. Click **Back** to return to live view.

Changing the camera sequence

The cameras are sequenced in numeric order by default. You can change the sequence order of the cameras for all monitors.

You can switch the channel of a camera with that of another camera in the system. This lets you, for example, have the images of camera 1 appear on channel 10, and the images of camera 10 appear on channel 1. This feature is useful when you want to watch the sequence of images from specific cameras so that they are next to each other on-screen.

See Figure 16 below. Each video tile displays both the order of the camera in the sequence and the camera number.

Figure 16: Camera layout and sequence screen

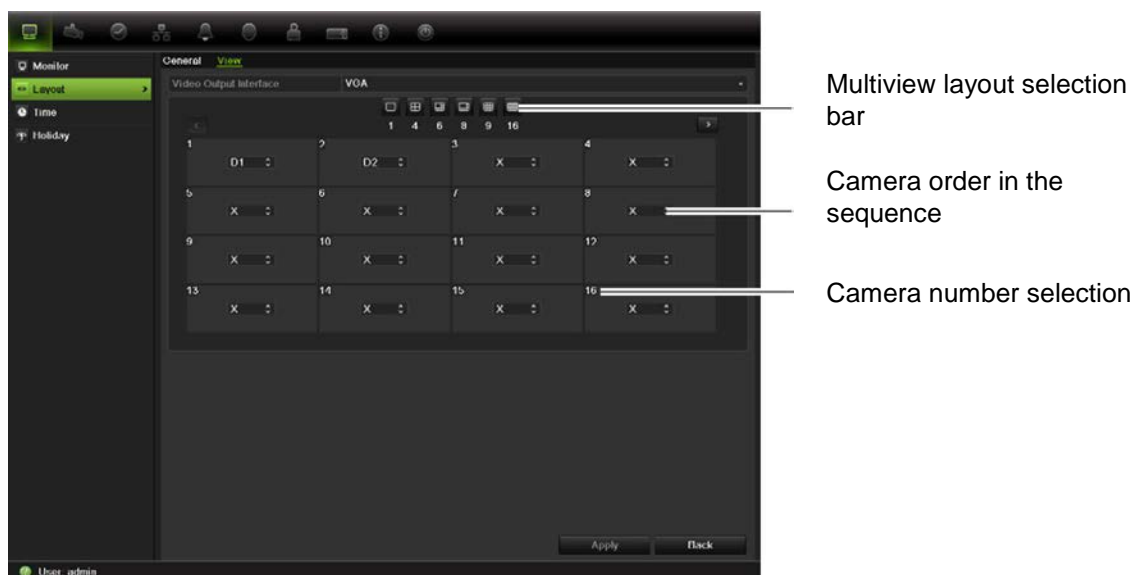

To set the camera sequencing:

1. Click the **Display Mode Settings** icon in the menu toolbar.
2. Select **Layout > View**.
3. From **Video Output Interface**, select the desired monitor from the drop-down list.
4. From the multiview layout selection bar, select the desired multiview layout.
5. Select the video tile of the camera whose order you want to change. The selected tile is highlighted green.
6. In the selected tile, select the new camera sequence order by scrolling the through the list of available camera numbers.

Note: “X” means that the camera is not displayed.

7. Click **Apply** to save the settings.
8. Click **Back** to return to live view.

General settings

Use this screen to configure the monitor image, GUI language, login password requirement, monitor resolution as well as to configure the NVR name and address. See Figure 17 below.

The TVN 50 can support NTSC or PAL video output. The video format is auto detected.

The changes are immediately implemented once Apply is clicked to save the settings.

Figure 17: Monitor setup screen: General Settings

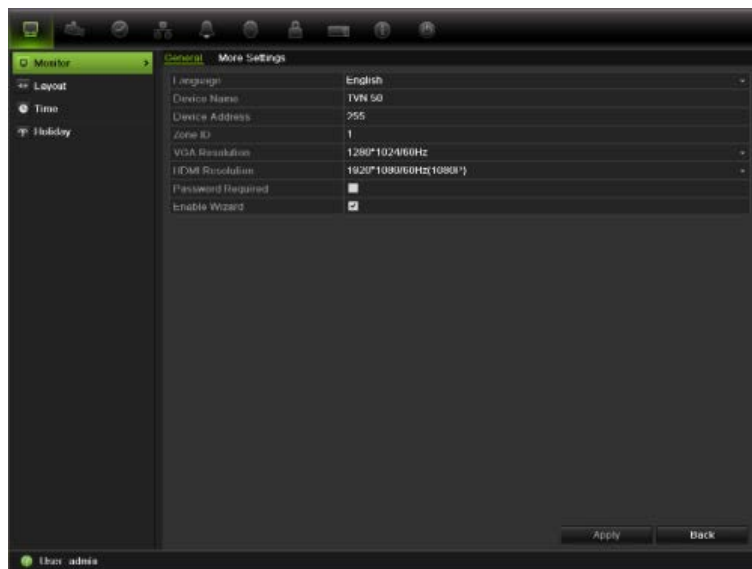

Table 11: Description of the Monitor setup screen: General Settings

Option	Description
Language	Change the language of the system. Select the desired language from the drop-down list and click Apply . The language displayed changes immediately.
Device name	Define the NVR name. The default name is TVN50. Click the edit box and enter the new name from the soft keyboard.
Device address	The device number to use for the NVR when programming the remote control or keypad. The default value is 255.
Zone ID	Each TVN in a daisy chain must have a unique zone ID so that it can be controlled by a KTD-405. The default value is 1.

Option	Description
VGA resolution	Define the VGA resolution. Select one of the options from the drop-down list and click Apply . The selected resolution must be the same as that of the monitor.
HDMI resolution	Define the HDMI resolution. Select one of the options from the drop-down list and click Apply . The selected resolution must be the same as that of the monitor.
Password required	Define whether a login password is required. Check the box to enable/disable and click Apply .
Enable wizard	Define whether the wizard tool starts when the NVR is turned on. Check the box to enable/disable and click Apply .

Figure 18: Monitor setup screen: More Settings



Table 12: Description of the Monitor setup screen: More Settings

Option	Description
Monitor standard	The video standard used is auto detected but can be manually changed. Modify the video standard used to PAL or NTSC and click Apply .
Output mode	Define the desired output mode. Select one of the options from the drop-down list: Standard, Bright, Soft, or Vivid.
Monitor brightness	Modify the video output brightness. Adjust the scroll bar point to the desired level and click Apply .
Event hint	Define whether the status icons appear on screen. See “Status information” on page 27 for more information.
TimeBar transparent	Modify the transparency of the menus on-screen relative to the background to make the menu screens easier to read or less prominent on-screen. Default is non-transparent. Select one of the options from the check box.
Enable TimeBar	Enable/Disable Time Bar in live view mode.
Menu timeout	Define the time in minutes after which the menu screen reverts to live view mode. Select a time from the drop-down list and click Apply .
Mouse pointer speed	Modify the speed of the mouse pointer. Adjust the scroll bar point to the desired level and click Apply .

Configuring time and date

You can set up the date and time that will appear on-screen. It is not included in recordings. This time and date display is separate from the embedded one that appears for each camera (see “Configuring the camera OSD settings” on page 117” on page 115 for more information on embedded camera time and date).

The start and end time of daylight savings time (DST) in the year can also be set. DST is deactivated by default. See Figure 19 below for the Time settings screen.

Figure 19: Time and date settings screen



Table 13: Description of the time and date settings screen

Option	Description
Time zone	Select the time zone of the NVR from the drop-down list.
Date format	Select the date format from the drop-down list. Default format is DD-MM-YYYY.
Time format	Select the time format from the drop-down list. Default format is 24-hour format.
Display week	Display the day of the week in the monitor time bar. Check the box to enable/disable. Default format is Disable.
System date	Define the system date. Default date is the current date.
System time	Define the system time. Default time is the current time.

Option	Description
Auto DST adjustment	Define DST is automatically. It depends on the time zone selected. Default format is Disable
Enable DST	Manually define DST. If this option is selected, the Auto DST adjustment option is disabled. Default format is Disable. Click the check box to enable or disable daylight savings time (DST).
From	Enter the start date and time for daylight savings.
To	Enter the end date and time for daylight savings.
DST bias	Set the amount of time to move DST forward from the standard time. Default is 60 minutes.

To set up the system time and date:

1. Click the **Display Mode Settings** icon in the menu toolbar.
2. Select **Time. Modify** the required settings.
3. Click the **Apply** button to immediately implement the changes.

Chapter 6

Controlling a PTZ camera

You can control PTZ dome cameras using the buttons on the front panel, the keypad, and IR remote control as well as using the PTZ control panel accessed with the mouse. Access to PTZ commands may require a password.

A detailed list of the PTZ commands available for many different camera protocols is available in Appendix F on page 153.

Calling up presets, tours and shadow tours

When in live view you can quickly call up the list of existing presets, preset tours and shadow tours by using the front panel, remote control, mouse and keypad.

Front panel	Press the joystick to Enter. PTZ control panel appears.
Mouse	Left-click the mouse on the desired camera image. The quick access toolbar appears. Click the PTZ control icon to enter PTZ mode. The PTZ control panel appears.
Remote control	Press the OK button. The PTZ control panel appears.
Keypad	Press the Enter ↵ button on the keypad. For further information, see Appendix D “KTD-405 keypad” on page 141.

If the display is in multiview format, it changes to full screen format for the selected camera. See Figure 20 below for a description of the PTZ control panel.

Figure 20: PTZ control panel

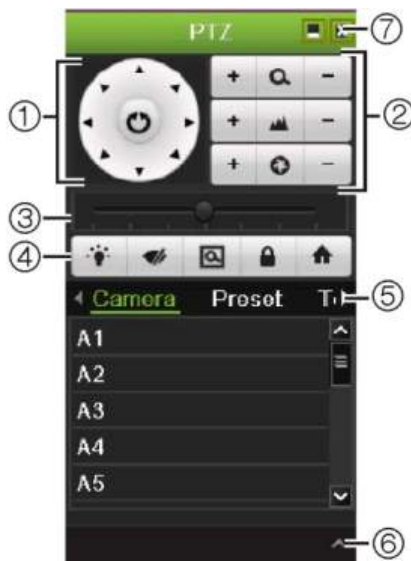







Table 14: Description of the PTZ control panel

Item	Name	Description
1.	Directional pad/auto-scan buttons	Controls the movements and directions of the PTZ. Center button is used to start auto-pan by the PTZ dome camera.
2.	Zoom, focus and iris	Adjusts zoom, focus and iris.
3.	PTZ movement	Adjusts the speed of PTZ movement.
4.	Toolbar	 Turns on/off camera light. This command is not supported on all PTZ cameras.  Turns on/off camera wiper. This command is not supported on all PTZ cameras.  Zoom area.  Centers the PTZ dome camera image. Not all PTZ cameras support this command.  Jumps to the home position.
5.	Select PTZ command	Displays the desired function from the scroll bar: camera, preset, preset tour or shadow tour.
6.	Open/close menu	Opens/closes the PTZ command section of the PTZ control panel.
7.	Exit	Exits the PTZ control panel.

Setting and calling up presets

Presets are previously defined locations of a PTZ dome camera. It allows you to quickly move the PTZ dome camera to a desired position. They are configured and modified from the PTZ configuration window (see Figure 21 below).

Note: The PTZ dome camera used must be able to support a preset command. See Appendix F on page 153 for the complete list of PTZ commands available by camera protocol.

Figure 21: PTZ configuration window

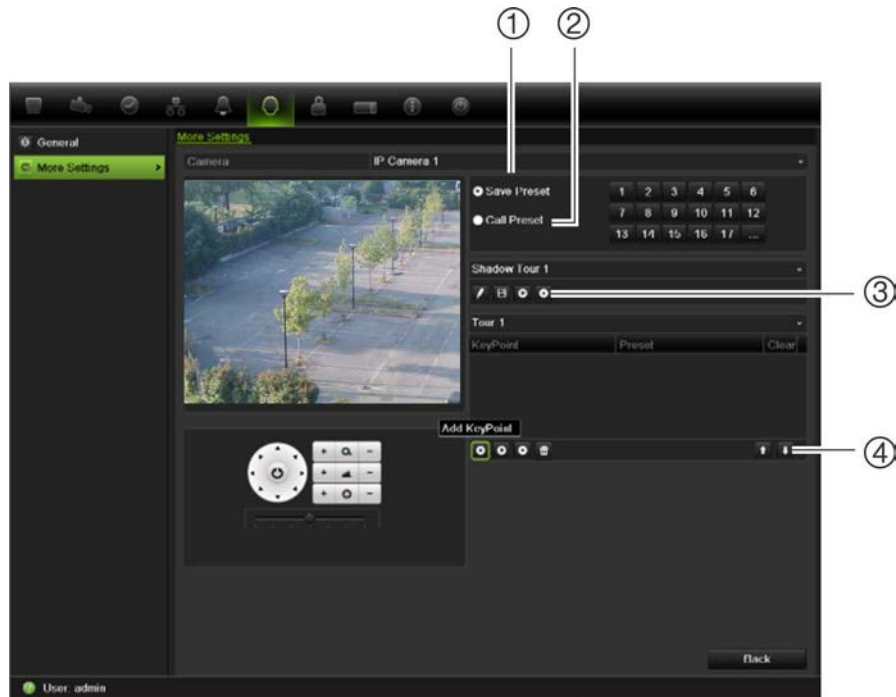











Table 15: Description of the PTZ configuration window

Item	Name	Description
1.	Save preset	Saves preset.
2.	Call preset	Calls up pre-existing preset.
3.	Shadow tour toolbar	 Starts recording the shadow tour.  Saves the shadow tour.  Starts the selected shadow tour.  Stops the selected shadow tour.
4.	Preset tour toolbar	 Adds a step to a selected preset tour.  Starts the selected preset tour.  Stops the selected preset tour.  Deletes all the preset tour steps.  Scrolls up the list.  Scrolls down the list.

To set up a preset:

1. Click the **PTZ Settings** icon on the menu toolbar and select **More Settings**.
2. Use the directional, zoom, focus and iris buttons to position the camera in the desired preset location.
3. Check **Save Preset** and enter a preset number. The preset is enabled and stored in the camera.

If the desired preset number is larger than the 17 numbers listed, click [...]. The Preset screen appears. Select a preset number from the dropdown list and click the **OK** button to save changes.

Note: Presets can be overwritten.

4. Click **Back** to return to live view.

To call up a preset:

- **PTZ control panel:**

1. In live view left-click the mouse and select the PTZ control icon in the quick access toolbar. The PTZ control panel appears. Select the desired camera from the toolbar.

– Or –

On the front panel, select the desired camera and press **Enter** on the joystick to call up the quick access toolbar. The PTZ control panel appears.

2. Scroll the toolbar to **Preset** and double-click the desired preset from the list. The camera immediately jumps to the preset position.

- **Menu toolbar:**

1. Click the **PTZ Settings** icon on the menu toolbar and select **More Settings**. The PTZ configuration window appears.
2. Check **Call Preset** and enter the preset number to call up. The camera immediately moves to that preset position.
3. Click **Back** to return to live view.

Setting and calling up preset tours

Preset tours move a PTZ dome camera to different steps (called “Keypoint” in the interface). The camera stays at a step for a set dwell time before moving on to the next step. The steps are defined by presets (see “Setting and calling up presets” on page 42.)

Each preset tour consists of steps. A step consists of a step number, a dwell time, and a speed.

The step number is the order the camera will follow while cycling through the preset tour. The dwell time is the length of time for which a camera stays at a

step before moving to the next one. The speed is the rate at which the camera will move from one key point to the next.

Note: The PTZ dome camera used must be able to support a preset tour command. See Appendix F on page 153 for the complete list of PTZ commands available by camera protocol.

To set up a preset tour:

1. Click the **PTZ Settings** icon on the menu toolbar and select **More Settings**.
2. Select the preset tour number.
3. In the preset tour toolbar, click  to add a step to the preset tour. The Keypoint window appears. Select the preset number, dwell time and speed of the step. Click **OK** to save the settings.

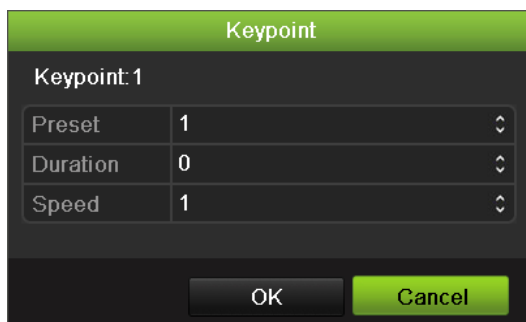

Note: A preset tour should have at least two presets.

4. Repeat step 3 to configure other steps (“Keypoints”) in the preset tour.

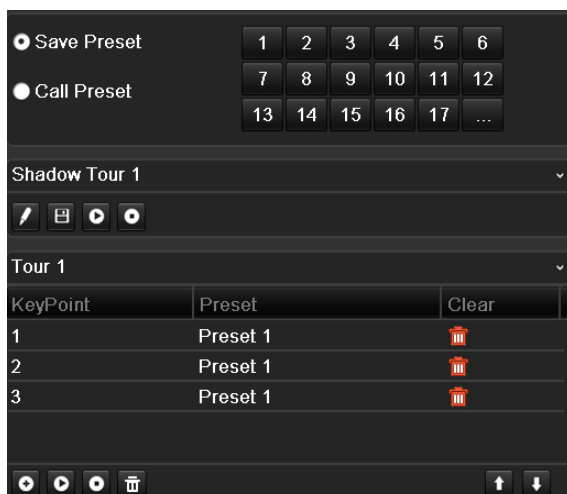

5. In the preset tour toolbar, click  to call up the preset tour.
6. Click **Back** to return to live view.

To delete a preset tour:

1. Click the **PTZ Settings** icon on the menu toolbar and select **More Settings**.
2. From the preset list, select a tour number and click  to delete the selected the preset tour.

– Or –

In the preset tour toolbar, click  to delete all the preset tours.

3. Click **Back** to return to live view.

To call up a preset tour:

- **PTZ control panel:**



1. In live view left-click the mouse and select the PTZ control icon in the quick access toolbar. The PTZ control panel appears. Select the desired camera from the toolbar.

– Or –

On the front panel, select the desired camera and press **Enter** on the joystick to call up the quick access toolbar. The PTZ control panel appears.

2. Scroll the toolbar to **Tour** and double-click the desired preset tour from the list. The camera immediately carries out the preset tour movement.

- **Menu toolbar:**



1. Click the **PTZ Settings** icon on the menu toolbar and select **More Settings**.
2. Select the desired preset tour from the list and click  to start the tour. Click  to stop the preset tour.
3. Click **Back** to return to live view.

Setting and calling up a shadow tour

The shadow tour command remembers the manually-controlled PTZ dome camera movement track. One shadow tour can be set up.

Note: The PTZ dome camera used must be able to support a shadow tour command. See Appendix F on page 153 for the complete list of PTZ commands available by camera protocol.

To set up a shadow tour:

1. Click the **PTZ Settings** icon on the menu toolbar and select **More Settings**.
2. Select the shadow tour from the list.
3. To record a new shadow tour, click  and use the directional buttons on the PTZ control panel to move the camera along the desired path.
4. Click  to save the shadow tour.

Note: The shadow tour can be overwritten.

5. Click **Back** to return to live view.

To call up a shadow tour:

- **PTZ control panel:**



1. In live view left-click the mouse and select the PTZ Control icon in the quick access toolbar. The PTZ control panel appears. Select the desired camera from the toolbar.

– Or –

On the front panel, select the desired camera and press **Enter** on the joystick to call up the quick access toolbar. The PTZ control panel appears.

2. Scroll the toolbar to **Shadow Tour** and double-click the shadow tour from the list. The camera immediately carries out the shadow tour movement.

- **Menu toolbar:**

1. Click the **PTZ Settings** icon on the menu toolbar and select **More Settings**.
2. Select the shadow tour from the list and click  to start the tour. Click  to stop the shadow tour.
3. Click **Back** to return to live view.

Chapter 7

Playing back a recording

The TVN 50 lets you to quickly locate and play back recorded video. There are four ways to play back video:

- Instant playback of the most recently recorded video
- All-day playback of the day's recorded video
- Search the video archives by specific time, date, bookmark, snapshot or event
- Search the system log

The NVR continues to record the live view from a camera while simultaneously playing back video on that camera display. You must have the access privilege to play back recordings (see “Customizing a user’s access privileges” on page 128 for more information).

Cameras in multiview mode play back simultaneously. This means, for example, that it is easy to follow the path of an intruder who has passed in front of several cameras.

Overview of the playback window

It is easy to manage playback from the playback window.

The playback video can be set up to display a time/date stamp for evidentiary purposes.

Figure 22: Playback window

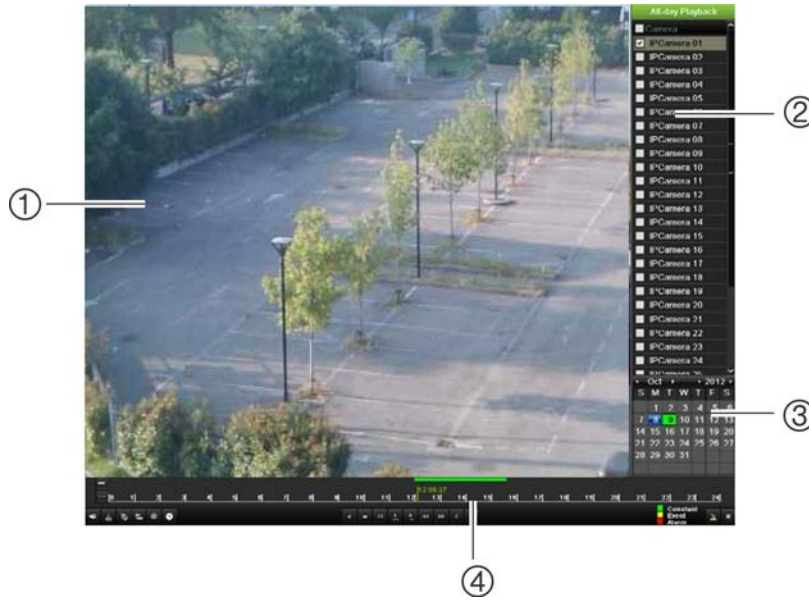

1. Playback viewer.
2. Camera panel. Select the cameras for playback. Move the mouse over the area to display the list of cameras available.
3. Calendar panel.
Blue: Current date
Green/Yellow/Red: Recordings available on the NVR.
4. Playback control toolbar. See Figure 23.

The playback control toolbar







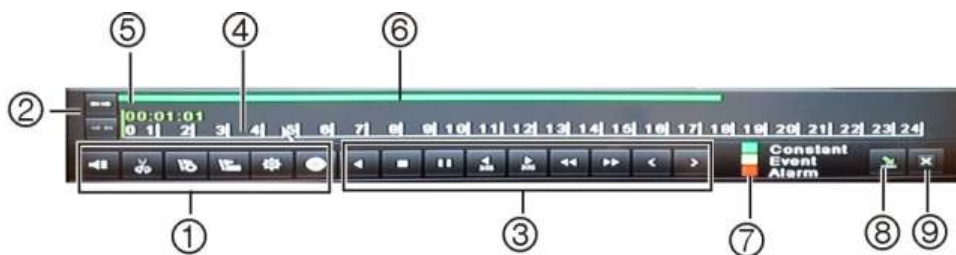



It is easy to manually control playback using the playback control toolbar. See Figure 23 below.

Note: The control toolbar does not appear for instant playback.

Figure 23: Playback control toolbar (all-day playback example shown)



Item	Description
1.	Audio and video control toolbar:
	/ Audio on/off.
	/ Start/stop a video clip during playback. Sections of a recording can be saved to an external storage device.
	Add default bookmark
	Add customized bookmark

Item	Description
	 Bookmark management. Click to see the list of bookmarks and their times.
	 Archive files
2.	Zoom control: Zoom in and out of the timeline to show the progress bar in greater or lesser detail.
3.	Playback control toolbar:
	 Reverse play the recording. Click again to pause.
	 Stop playback. Timeline jumps back to 00:00 time (midnight).
	 Play recording.
	 Fast forward playback by 30 seconds.
	 Reverse playback by 30 seconds.
	 Decrease playback speed: Options available are: single frame, 1/8 speed, 1/4 speed, 1/2 speed, normal, X2 speed, X4 speed, X8 speed, maximum speed.
	 Increase playback speed. Options available are: single frame, 1/8 speed, 1/4 speed, 1/2 speed, normal, X2 speed, X4 speed, X8 speed, maximum speed.
	 Previous file/day/event recording.
	 Play next file/day recording in the search result.
4.	Timeline: Allows you to jump forwards or backwards in time. The timeline moves left (oldest video) to right (newest video). Click a location on it for where you want playback to start. In all-day playback the cursor shows the actual time. In search playback, the cursor is a ball.
5.	Time bar: Time of actual playback. This is only displayed in all-day playback.
6.	Playback progress bar: This bar displays how far playback of the recording has progressed. It also indicates the type of recording.
7.	Recording type: Description of the color coding of recording types that appear in the playback progress bar. Green indicates continuous recording. Red indicates alarm/event recording. Yellow indicates motion recording.
8.	Hide the playback control toolbar.
9.	For all-day playback mode, quit playback and return to live view. For playback from search mode, quit playback and return to the search screen.

Playback pop-up menu

You can quickly access playback functions by placing the cursor on a playback image on screen and clicking the right-button of the mouse. The playback pop-up menu appears (see Figure 24 below).

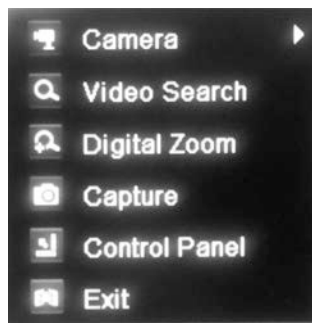
Figure 24: The all-day playback pop-up menu

Item	Name	Description
1.	Camera	Select a camera for playback. Note: This option is not available if you play back a video file from the list of a search result.
2.	Video search	Call up the Search window to search for recorded video files.
3.	Digital zoom	Enter the digital zoom function for the selected camera.
4.	Capture	Capture a snapshot of the video playing back.
5.	Control panel	Hide the playback control toolbar.
6.	Exit	Return to live view.

Instant playback



Use the quick access toolbar to quickly replay recorded video from the last five minutes. This can be useful to review an event that has just happened. Only one camera at a time can be selected. The default playback period of 5 minutes cannot be changed.

To instantly replay recorded video:

1. In live view mode left-click the mouse on the desired camera image. The quick access toolbar appears. Click **Instant Playback** .
2. Select the desired camera from the drop-down list and click **OK**.

Playback starts immediately. The Instant Playback scroll bar appears under the selected camera.



3. Click **Pause**  on the toolbar to pause playback.
Click **Play**  to restart playback.
Click **Stop**  to stop playback and return to live view.

All-day playback

Use this option to play back recorded video from the last day. Playback starts at midnight and runs for the 24-hour period. All-day playback is shown in full screen view. See Figure 23 on page 50 for a description of the playback control toolbar.

• Using the mouse:

1. In live view mode right-click the mouse on the desired camera image. In the mouse toolbar click **All-day Playback**.

The playback screen appears. By default, the camera is in full-screen mode.

2. To select more than one camera for multiview playback or to select playback from a different day, move the mouse to the right edge of the screen. The camera list and calendar appear. Check the desired cameras and/or another day. Up to 32 cameras can be selected.

Playback starts immediately.

Note: A message appears if there are no recordings found during this period.

3. Use the playback control toolbar to manually control playback.
4. Click **Exit**  to return to live view.

– Or –

Right-click the mouse and click **Exit** from the mouse menu to return to the previous screen.

• Using the front panel:

1. Select the camera for playback and press the **Play** button. Playback from the selected camera starts immediately.

Note: Multiview playback is only available using the mouse. If live view was showing multiview, only the camera in the top-left channel on screen will be played back.

2. To select a different camera for playback, press the numerical button of the desired camera.
3. Click **Live** to return to live view.

Searching recorded video

You can easily search and play back recorded videos by time, events, bookmarks, and video clips.

The Search window has four submenus that allow you to carry out different searches by theme:

Search type	Description
Normal	Search all recorded video by cameras, recording type, type of file protection (locked or unlocked) and time period.
Event	Search only event recorded files. Files can be searched by alarm inputs, motion detection, or POS/ATM text insertion. Note: Only motion detection and POS/ATM text insertion that have been recorded as events will be listed in this search. Motion and text insertion that is recorded as a non-event can be searched under the Normal menu.
Bookmark	Search only recorded files with bookmarks.
Picture	Search only recorded files with pictures.

Search results

A search will usually produce a list of files, which may extend to several pages. The files are listed by camera, and then for each camera by date and time. The latest file is listed first. See Figure 25 on page 55 for an example of a search.

Only one file can be played back at a time.

Figure 25: Example of a search result list

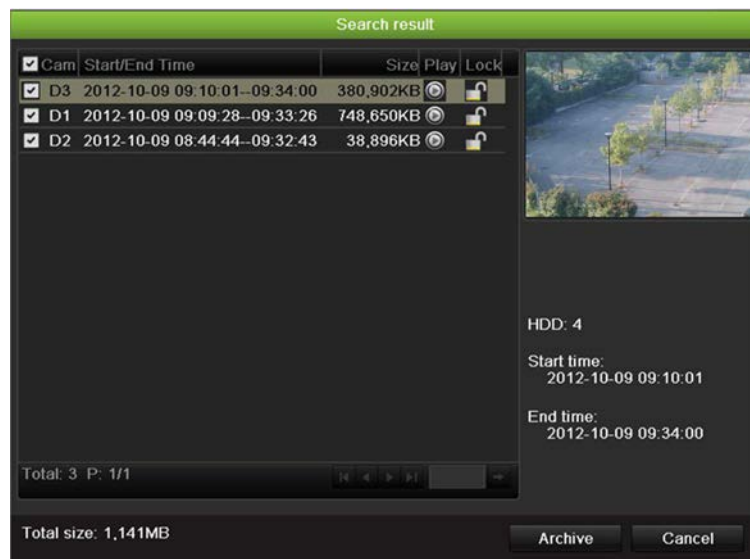

Playing back recordings by time and video type

You can search recorded video by time and video type, such as continuous recordings, motion, text insertion, alarm and all recordings. Video can be played back simultaneously across several cameras.

To play back search results:

1. In live view mode right-click the mouse and in the mouse menu select **Advanced Search > Normal**.
2. Select the desired cameras, record type, file type as well as start and end time of the recording.
3. Click **Search**. The list of search results appears.

If you selected “Motion” or “Text insertion” as the event type, select the required IP cameras. If you selected “Text insertion”, also enter the desired keyword.

4. Play back the search results:

If there is only one camera in the search result, click its playback button. Playback starts.

If there is more than one camera listed, click the playback button of one of the cameras. In the window that appears, select the cameras you want to play back simultaneously and click **OK**. Playback starts.



5. To hide the playback control toolbar during play back, right-click the mouse and select the **Control Panel** button in the playback control toolbar. Click again for the panel to reappear.
6. Use the playback control toolbar to manually control playback.

7. To play back another camera, move the cursor to the right edge of the screen to display the list of cameras and select the desired camera.
8. To do another search:
Click **Exit**  in the playback control toolbar to return to the search results screen.
- Or -
Right-click the mouse and select **Exit** from the list to return to the search results screen.
- Or -
Right-click the mouse and select **Video Search** from the list to return to the search screen.

Playing back recordings by event

You can search recorded video by event type: motion, alarm input and POS/ATM text insertion. Video can be played back simultaneously across several cameras.

To play back search results:

1. In live view mode right-click the mouse and in the mouse menu select **Advanced Search > Event**.
2. Select the desired event type as well as start and end time of the recording.
3. Select the desired alarm inputs.
4. Click **Search**. The list of search results appears.
5. Play back the search results:
If there is only one camera in the search result, click its playback  button. Playback starts.
If there is more than one camera listed, click the playback  button of one of the cameras. In the window that appears, select the cameras you want to play back simultaneously and click **OK**. Playback starts.
6. To hide the playback control toolbar during playback, right-click the mouse and select the **Control Panel** button in the playback control toolbar. Click again for the panel to reappear.
7. Use the playback control toolbar to manually control playback.
8. To play back another camera, move the cursor to the right edge of the screen to display the list of cameras and select the desired camera.
9. To do another search:
Click **Exit**  in the playback control toolbar to return to the search results screen.

- Or -

Right-click the mouse and select **Exit** from the list to return to the search results screen.



- Or -

Right-click the mouse and select **Video Search** from the list to return to the search screen.

Creating and playing back bookmarked recordings

You can bookmark the important scenes in a recorded file for later reference.

Bookmarks flag the start of a scene. Up to 64 bookmarks can be saved in a video file. There are two types of bookmarks:

- **Default bookmark** : All default bookmarks have the same generic name, "Bookmark".
- **Customized bookmark** : The bookmark is given a name for easy identification. The same name can be used for several bookmarks.

Both types can be searched.

To create a bookmark:

1. Open an all-day playback screen or the playback screen from a search result.
2. In the all-day playback recording, click the timeline bar where you want the bookmark to be. The green time line jumps to this position. Click the button for the type of bookmark you want, and enter the bookmark name if required.

In the playback recording from a search, click the scroll bar where you want the bookmark to be. The scroll bar ball jumps to this position. Click the button for the type of bookmark you want, and enter the bookmark name if required. The bookmark is saved.

3. Click the bookmark management  button to see the list of bookmarks saved. The name of a bookmark can be edited. The bookmark can also be deleted.

To play back a bookmark:

1. In live view mode right-click the mouse and select **Advanced Search > Bookmark** in the mouse menu.
2. Select the desired cameras as well as start and end time of the recording to be searched. Also select the type of bookmark to be searched.

If searching for customized bookmarks, enter a keyword from the bookmark name.



Click **Search**. The list of bookmarks appears.

3. Select a bookmark and do one of the following:
Click the **Edit** button to edit a bookmark's name.
Click the **Delete** button to delete a bookmark.
- Or -
Click the **Play** button to play back a bookmark.
4. When finished, click **Exit**.

Slideshow of snapshots

You can search video snapshots. See "Accessing frequently used commands" on page 31 on how to create snapshots.

To play back search results:

1. In live view mode right-click the mouse and in the pop-up menu select **Advanced Search > Picture Search**.
2. Select the desired cameras as well as start and end time of the recording to be searched.
3. Click **Search**. The list of snapshots appears.
4. Select a snapshot to see it in the thumbnail window. Click its **Play**  button to see it in full-screen mode.
5. When in full-screen mode, move the cursor to the right edge of the screen to see the complete list of snapshots found in the search. Click their **Play** buttons to see them in full-screen mode.
6. To see a slideshow of all the snapshots found, click the **▶** or **◀** buttons on the snapshot toolbar to sequence forwards or backwards through the shots.
7. To do another search:
Click **Exit**  in the snapshot toolbar to return to the search results screen.
- Or -
Right-click the mouse and select **Exit** from the list to return to the search results screen.
- Or -
Right-click the mouse and select **Picture** from the list to return to the search screen.
- Or -
Click **Picture Search** in the snapshot toolbar to return to the search results screen.

Playing back recordings from the system log

You can also playback recordings from the system log. The system log provides a much wider range of options for playback than Advanced Search, which deals with video detection and alarms only.

Figure 26: View log screen

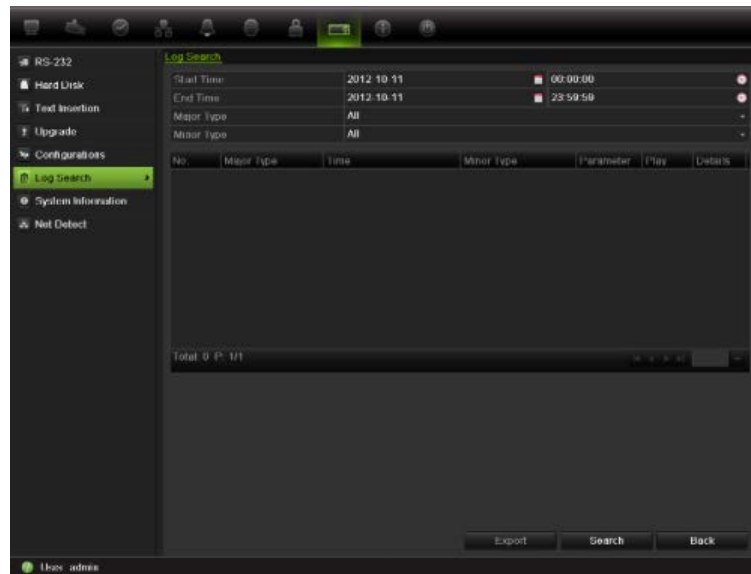

To play back video from the system log:

1. Click **System Settings > Log Search** in the menu toolbar.
2. Select the search start and end times.
3. Under **Major Type** and **Minor Type**, select an option from the drop-down list. The minor type list of options available depends on the option selected under major type.
4. Click the **Search** button. A list of results appears.
5. Select a file and click:
 - **Details:** Displays information on the log or recording. For a recording, it lists such information as start time, type of information, camera number, and gives a description on the types of events recorded and when record time was stopped.
 - **Play:** Click to start playback of the selected recording.
 - **Export:** Click to archive the selected file to a USB device. The export screen appears.
 - **Back:** Click to return to the previous screen.

Playing back frame-by-frame

You can easily play back a selected video at different speeds. This allows you to carefully examine an event frame-by-frame as it happens.

The current frame rate is shown on the right of the playback control toolbar.

To play back frame-by-frame:

• Using a mouse:

1. In playback mode click the **Speed Down** ⏪ and **Speed up** ⏩ buttons in the playback control toolbar until the speed changes to single frame.
2. Click the **Pause** button to advance the video frame by frame.

• Using the front panel:

1. In playback mode move the joystick to left and right to scroll down and up through the speed changes until single frame.
2. Press **Enter** with the joystick to advance the video frame by frame.
3. Press the **Play** button to continue playback at normal speed.

Digital zoom in playback

You can easily zoom in on an image during playback to see it in greater detail.

To digitally zoom-in during playback:

1. In playback mode right-click the mouse and click **Digital Zoom** in the pop-up menu. The playback control toolbar disappears.
2. Click the screen with the cursor.
The image zooms in and the digital view screen appears.
3. Left-click the mouse and drag the red square to the area of interest, or move the joystick on the front panel to position the red square. The selected area is magnified.
4. Right-click the mouse to quit the digital zoom mode and to return to full-screen playback mode. The playback control toolbar reappears.

Chapter 8

Archiving recorded files

Archive recorded files on an external device such as a USB flash drives, USB HDDs, eSATA HDD or a DVD writer.

Before starting to archive files, ensure that you have the backup device connected to the NVR. It can be detected automatically by the NVR.

It is important that the external storage device is set to the Export option in order to be able to archive. See ““Using an external recording device” on page 83”.

Note: The USB port on the rear panel does not support USB CD/DVD burners or USB HDDs.

Archiving files

There are two ways to archive files:

Quick Archive: Quick archive lets you archive recorded files quickly by using the Archive button on the front panel. The NVR then downloads all the recorded files on the unit to fill the available memory space on the media. This option is not available via the mouse.

Advanced Search screen: You can specify archiving settings such as a specific time and date period, recording type, start and end times, as well as cameras.

Using Quick Archive

To archive recorded video using Quick Archive:

1. Insert the backup device into the TVN 50.

If using a USB memory drive, insert the device into the USB port on the front panel. If using a digital video disk (DVD) or eSATA drive, insert the disc into the DVD drive. If more than one media type is found in the TVN 50, the USB device takes precedence over the others.

2. Press **Archive** on the front panel or remote control to open the quick archive screen.

3. Click **Start**. The unit starts to download all the files listed.

Note: If there is a capacity limitation on the backup device, only the most recent files will be backed up.

A message will appear to confirm when the download is complete.

Exporting recorded files to a backup device

You can insert a mini-USB hub to the USB port to attach a mouse for navigation or a USB drive for archiving. However, the unit may not support all types of USB hubs.

The Archive options available may depend on the type of backup device selected.

Figure 27: Example of an archive

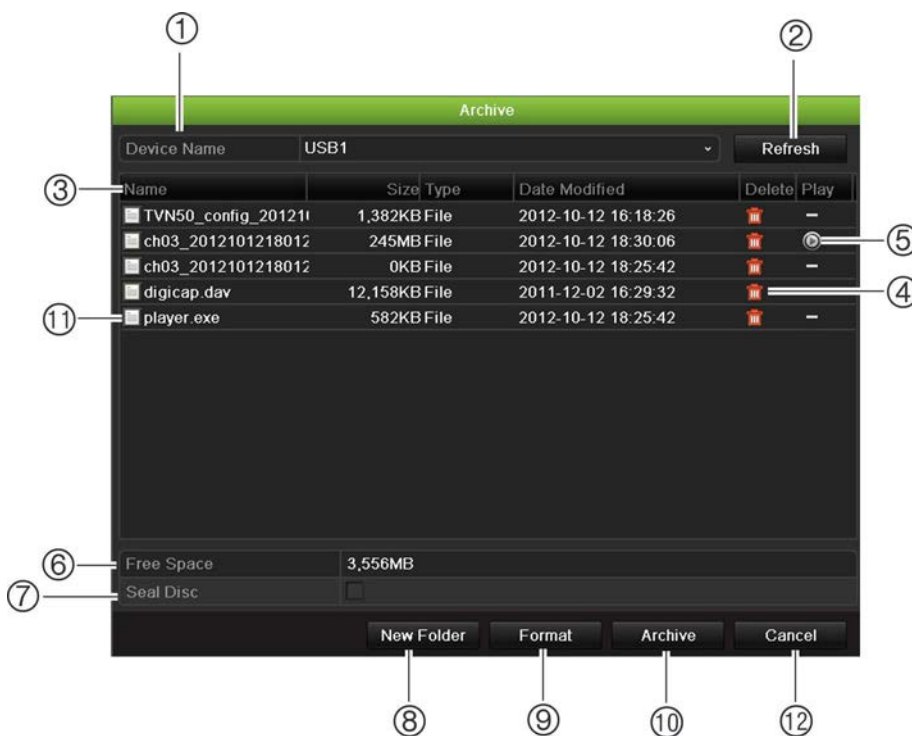

Item	Function	Description
1.	Device name	Select one of the storage media for archiving. If the backup device is not recognized: <ul style="list-style-type: none"> • Click the Refresh button • Reconnect device • Check for compatibility from vendor
2.	Refresh	Refresh the search results if any parameters have been modified.
3.	Name	Files found on the backup device are listed.
4.	Delete	Click to delete a selected file from the backup device.
5.	Play	Click to play selected file.

Item	Function	Description
6.	Free space	Free space available on the backup device is displayed.
7.	Seal disc	Select to prevent other files being recorded onto the disc.
8.	New folder	Create a new folder on the backup device. Files from the NVR can be archived to a specific folder.
9.	Format	Format the USB/eSATA drive.
10.	Archive	Start downloading selected files onto the backup device.
11.	Player Backup	Select to include a backup player.
12.	Cancel	Cancel search and return to previous menu.

To export recorded files to a backup device:

1. Connect the backup device to the NVR.

If using a USB memory drive, insert the device into the USB port on the front panel. If using a digital video disk (DVD) or eSATA drive, insert the disc into the DVD drive. If both media are found in the TVN 50, the USB device takes precedence over the DVD.

2. In live view mode press the **Search** button on the front panel or remote control.

- Or -

Right-click the mouse and select **Advanced Search**.

The Advanced Search screen appears.

3. Select the cameras and search parameters required.

Record type: All, constant, motion, text insertion, alarm, or manual.

File type: All, locked, or unlocked.

4. Select the desired start and end times and dates for the recordings.

5. Click **Search**. The list of results appears.

6. Select the files to export.

Note: You can click the Play button to verify that the selected files are the files to export.

7. Click **Archive**. The Archive screen appears.

8. Select the storage medium to export to from the drop-down list.

9. Click **Archive** to begin the backup process.

10. Click **OK** when archiving is completed. Click **Cancel** until you return to live view.



Creating and archiving video clips

You can save important scenes in a recorded file for later reference by creating video clips of selected portions of the file during playback. When an intruder, for example, crosses in front of several cameras you can save the video clip of the intruder's path across these cameras in a single file.

Up to 30 video clips can be made from a recording.

Note: This feature is only available using the mouse.

To export video clips during playback:

1. Connect the backup device to the NVR.
2. Search for the required files to play back. See "Searching recorded video" on page 54.
3. Select the file or files to play back and click **Play**. Playback starts immediately.
4. Click the playback timeline where you want the video clip to start and click the **Start Clip**  button.
5. Click the playback timeline where you want the video clip to stop and click the **End Clip**  button.
6. Repeat for additional clips.
7. Exit playback mode. A message appears asking if you want to save the video clips.
8. Click **Yes** to archive the clips. The Export screen appears.
Click **No** to exit and return to the previous screen. The clips are not saved.
9. In the Archive screen, select the backup device to be used from the drop-down list.
10. Click **Start**. File downloading starts.

Note: You can create a new folder for the video clips. Press the **New Folder** button and enter the folder name.

Archiving snapshots

You can save all the video snapshots recorded to a backup device.

To archive snapshots:

1. Connect the backup device to the NVR.
2. Search for the required snapshot files to play back. See "Slideshow of snapshots" on page 58. The list of snapshots appears.
3. Select the snapshots to backup.

4. Click **Archive**. Select the archiving device, if different from that listed.
5. Click **Archive**. Export starts immediately.
6. When completed, click **OK**. Click **Cancel** to return to the previous screen.

Managing backup devices

You can manage backup devices from the Export screen (see Figure 27 on page 62.)

The Export screen allows you to:

- **Create New Folder:** Create a new folder on the backup device.
- **Delete:** Delete a file or folder from the backup device.
- **Play:** Play the selected video file from the backup device.
- **Format:** Format the backup device.
- **Erase:** Erase files from a re-writable CD/DVD.

Playing back archived files on a PC

Use the standard file player software to play back the archived video on your PC. It is downloaded from the NVR when archiving files onto a backup device.

Chapter 9

Using the web browser

This chapter describes how you can use the web browser interface to configure the device, play back recorded video, search through event logs, and control a PTZ dome camera. You can also specify settings on the web browser interface to optimize video playback and recording performance when operating in a low or limited bandwidth environment.

Windows Vista and 7 users

Internet Explorer for Windows Vista and Windows 7 operating systems have increased security measures to protect your PC from any malicious software being installed. When using the NVR web browser interface, you can install ActiveX controls to connect and view video using Internet Explorer.

To have complete functionality of the web browser interface and the NVR player with Windows Vista and Windows 7, do the following:

- Run the Browser interface and the NVR player application as an administrator in your workstation
- Add the NVR's IP address to your browser's list of trusted sites

To add the NVR's IP address to Internet Explorer's list of trusted sites:

1. Open Internet Explorer.
2. Click **Tools**, and then **Internet Options**.
3. Click the Security tab, and then select the Trusted Sites icon.
4. Click **Sites**.
5. Clear the "Require server verification (https:) for all sites in this zone" box.
6. Enter the IP address or DDNS name in the "Add this website to the zone" field.
7. Click **Add**, and then click **Close**.
8. Click **OK** in the Internet Options dialog screen.
9. Connect to the TVN 50 for full browser functionality.

Accessing the web browser

To access the TVN 50, open a web browser and enter the IP address assigned to the TVN 50, as a web address. On the logon screen, enter the default user ID and password.

Note: Only one NVR can be viewed per browser.

User ID: admin

Password: 1234

The default values for TVN 50 network settings are:

- IP address - 192.168.1.82
- Subnet mask - 255.255.255.0
- Gateway address - 192.168.1.1
- Ports:

When using the browser:

RTSP port: 554

HTTP port: 80

When using TruNav:

RTSP port: 554

Server/Client software port: 8000

For more information on port forwarding, see Appendix C “Port forwarding information” on page 141.





Web browser overview





The NVR web browser lets you view, record, and play back videos as well as manage all aspects of the NVR from any PC with Internet access. The browser’s easy-to-use controls give you quick access to all TVN 50 functions. See Figure 28 below.

Figure 28: Live view in the web browser interface



Table 16: Description of live view in the web browser

Item	Name	Description
1.	Camera	View video and record video from the selected camera.
2.	Menu toolbar	Lets you do the following: <ul style="list-style-type: none"> • View live video • Play back video • Search for event logs • Configure settings • Log out of the interface
3.	Viewer	View live or playback video.
4.	Display format	Define how you want video to be displayed in the viewer: Multiview or full screen.
5.	Video function toolbar	Lets you do the following in live view: <ul style="list-style-type: none">  Switch between mainstream and substream.  Start/stop all streaming from selected cameras.  Start recording from selected cameras.  Turn POS/ATM text insertion on/off.  Take a video snapshot.

Item	Name	Description
		 View previous and next camera respectively.
		 If viewing in multiview format, live view moves to the next group of cameras for the selected number of video tiles.
		 Turn audio on/off
		 Turn microphone on/off
6.	PTZ panel	Hide/display the PTZ panel.

Using the web browser to configure the device

Click **Configuration** on the browser menu bar to display the configuration screen. There are two ways to configure the NVR: Local and Remote.

Local configuration

Local configuration lets you define communication and network parameters such as protocol type, maximum file size, stream type and network transmission settings. You can also specify the directory locations for saving recorded and playback video, captured images, and downloaded files.

Remote configuration

Remote configuration lets you remotely configure the following NVR settings:

See Figure 29 below for an example of the Configuration screen. See Table 17 on page 71 for an overview of the different browser menu functions. Please refer to the specific sections on the OSD menu functions for more information on configuring these functions.

Note: The configuration settings defined remotely are different from those that can be defined locally.

Figure 29: Remote browser configuration screen (Display Settings window shown)

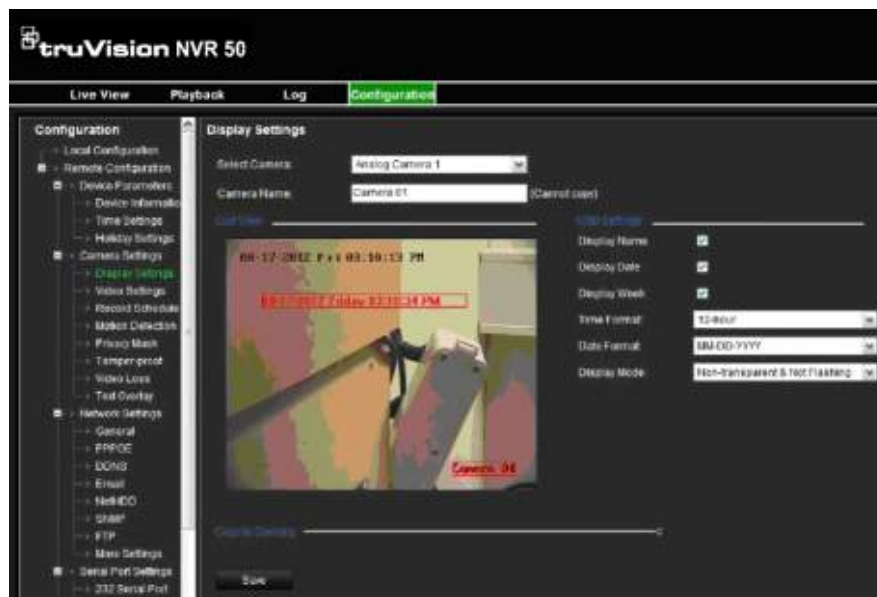

Table 17: Description of remote configuration menus

Menu	Function	Description
Device parameters	Device information	<p>Device name: Define the NVR name. The default name is TVN 21.</p> <p>Device number: The device number to use for the NVR when programming the remote control. The default value is 255.</p> <p>Zone ID: Each NVR in a daisy chain must have a unique zone ID so that it can be controlled by a KTD-405. The default value is 1.</p> <p>Overwrite: Enable or disable. Enabling this setting causes recorded files to be overwritten once the HDD is full.</p> <p>eSATA: Define how an external recording device saves records. See “Using an external recording device” on page 83 for more information.</p> <p>Event priority: Define the priority between text insertion event and motion alarm if both are triggered at the same time. Default is Motion alarm (Text In < Motion).</p>
	Time settings	Define time and date. See “Configuring time and date” on page 38 for more information. See “Configuring an NTP server” on page 102 for information on setting up NTP time settings.
	Holiday settings	Define how recordings occur during holiday periods. See “Holiday schedules” on page 86 for more information.
Camera settings	Display settings	Define which information is displayed on-screen. See “Configuring the camera OSD settings” on page 117 on page 115 for more information.
	Video settings	Define general recording settings. See “Defining a recording schedule” on page 84 for more

Menu	Function	Description
		information.
	Recording schedule	Define the recording schedules. See “Defining a recording schedule” on page 84 for more information.
	Motion detection	Define motion detection parameters. See “Setting up motion detection” on page 92 for more information.
	Privacy mask	Define the on-screen privacy mask areas. See “Setting up privacy masking” on page 118 for more information.
	Tamper-proof	Define the video tampering detection settings. See “Detecting video tampering” on page 98 for more information.
	Video loss	Define the video loss detection settings. See “Detecting video loss” on page 97 for more information.
	Text overlay	Add extra lines of text on screen. See “Text overlay” on page 78 for more information.
Network settings	General	Define the general network settings. See “Configuring general network settings” on page 99 for more information.
	PPPoE	Define the PPPoE settings. See “Configuring PPPoE” on page 101 for more information.
	DDNS	Define the DDNS settings. See “Configuring DDNS” on page 101 for more information.
	Email	Define the settings to send an e-mail. See “Configuring e-mail” on page 103 for more information.
	NethDD	Define the remote storage system for NVR recordings. See “Using a network storage system” on page 78 for more information.
	SNMP	Define the SNMP settings. See “Configuring SNMP” on page 103 for more information.
	FTP	This function is currently unavailable.
	More settings	Define a remote alarm host, multicast IP as well as the server, HTTP, and RTSP ports. See page 105 for more information.
Serial port settings	232 serial port	Define the RS-232 parameters. See “Configuring the RS-232 port” on page 121 for more information.
	485 serial port	Define the RS-485 parameters.
Alarm settings	Alarm input	Define the alarm input parameters for when an external alarm is triggered. See “Setting up external alarms” on page 94 for more information.
	Alarm output	Define the response when an external alarm is triggered. See “Setting up external alarms” on page 94 for more information.









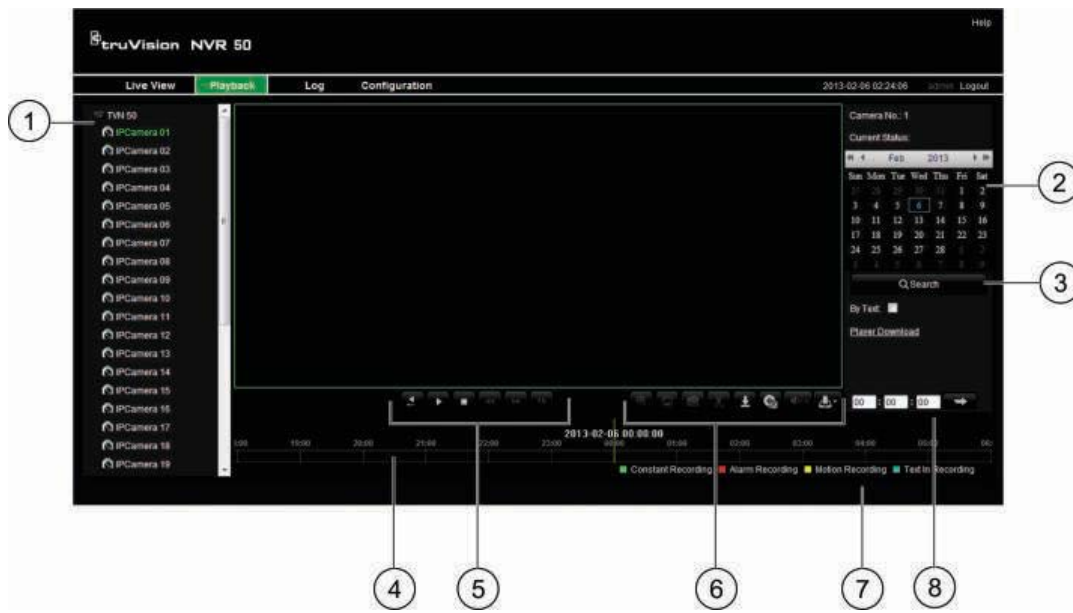

Menu	Function	Description
Notification		Define the notification parameters when irregular events occur such as HDD full. See “Description of alarm notification types” on page 91 and “Setting up system notifications” on page 96.
User management		Define, modify, and delete users. See Chapter 16 “User management” on page 127 for more information.
HDD management	Basic settings	Initialize the HDD. See “Initializing HDDs” on page 109 for more information.
	Storage mode	Define the storage capacity of the HDD. See “Controlling disk space on the HDD” on page 109 for more information.
Maintenance		Remotely update the NVR firmware, restore default factory settings, restart the NVR, and import/export parameters remotely. See Chapter 15 “NVR management” on page 121 for more information.
Text insertion		Define access device, access mode, and start string. See “Capturing text insertions” on page 76.
System information	Camera, Record, Alarm, Network, and HDD	Review the status of the cameras, recordings, alarms, network, and HDDs. See “Viewing system information” on page 123 for more information.

Searching and playing back recorded video

To search and play back recorded video, click Playback on the menu bar to display the Playback page shown in Figure 30 below.

Figure 30: Browser playback page



Item	Description
1.	Selected camera.
2.	Calendar: Selected day is highlighted.
3.	Search: Click to start searching recorded files for the selected camera.
4.	Timeline: The timeline moves left (oldest video) to right (newest video). Click a location on the timeline to move the cursor to where you want playback to start.
5.	Playback control toolbar: <ul style="list-style-type: none">  Reverse: Click to reverse playback.  Start/stop: Start or stop playback.  Stop playback. Timeline jumps back to 00:00:00 time (midnight) of the previous day.  Playback slow forward: Click to scroll through the different speeds available: single frame, 1/8 speed, 1/4 speed, 1/2 speed, normal, X2 speed, X4 speed, X8 speed, maximum speed. Current speed is displayed under the camera name on top right of window.  Playback fast forward: Click to scroll through the different speeds available: single frame, 1/8 speed, 1/4 speed, 1/2 speed, normal, X2 speed, X4 speed, X8 speed, maximum speed. Current speed is displayed under the camera name on top right of window.  Single frame: Click to play back one frame at a time.
6.	Audio and video control toolbar: <ul style="list-style-type: none">  Text insertion: Click to enable/disable POS/ATM text display in playback.  Snapshot: Capture a snapshot of the video.  Video clips: Start/stop video clip during playback. Sections of a recording can be saved to an external storage device.  Download: Download video clips.  Backup: Click to make back up of recorded files to save locally on the NVR. A list of the recorded files appears

Item	Description
	 Audio: Click to enable/disable audio.
7.	<p>Type of recording:</p> <p>Green: Indicates video recorded based on the recording schedule defined.</p> <p>Red: Indicates video recorded triggered by an alarm event.</p> <p>Yellow: Indicates video recorded triggered by motion detection.</p> <p>Blue: Indicates video recorded triggered by a POS/ATM text recording.</p>
8.	Jump start: Enter a precise time in the box and click the Go To button to jump start the playback at this selected time.

Select a camera and a day to search from on the calendar displayed, and then click Search. The timeline below the page indicates video recorded for the specified day. The timeline also classifies by color the type of recording with each type.

Click and drag the marker across the timeline on where you want video playback to begin, and then click Play on the playback control toolbar. You can capture a snapshot of a video image, save the video playback, or download the recorded video.

Searching for event logs

The NVR compiles a log of events, such as the start or end of video recording, NVR notifications, and alarms, through which you can easily search. Logs are categorized by the following types:

- **Alarm:** Includes motion detection, tamper detection, video tampering, and other alarm events
- **Notifications:** Includes system notifications such as video loss, HDD failures, and other system-related events
- **Operations:** Includes users access to the web interfaces and other operational events
- **Information:** Includes general information on the NVR actions, such as the start and end of video recording, etc.

To search for logs, click Log on the menu bar, select a log type, specify a date and time range, and then click Search.

Controlling a PTZ dome camera in the web browser

The web browser interface lets you control the PTZ functions of a dome camera. Click a PTZ dome camera and use the PTZ controls on the interface to control the PTZ functions.

Figure 31: PTZ controls

1. Directional pad/auto-scan buttons: Controls the movements and directions of the PTZ. Center button is used to start auto-pan by the PTZ dome camera.
2. Adjust zoom, focus, and iris.
3. Adjust speed of PTZ dome camera.
4. Start selected preset.

Capturing text insertions

Text insertion lets you insert or display text from a point-of-sale (POS) system on the video display of the NVR. The text is saved and time-stamped together with the video. You can then search the text for specific video clips. The text is displayed during playback.

The NVR supports POS and ATM text insertion via the UTC ProBridge accessory connected to the RS-232 port on the NVR. This feature is currently only available using the browser.

In both live view and playback, a camera set up for text insertion will display the video with the POS text overlay.

See Figure 32 below for an example of a video image in live view with text insertion.

Figure 32: Example of a video image with text insertion



To set up text insertion:

1. Click the **Configuration** tab in the browser toolbar and then select **232 Serial Port**.
2. Under Usage, select **ProBridge**.
3. In the submenu panel, select **Text Insertion**.
4. Check **Enable text insertion**.
5. Select the access device from the drop-down list.
6. Select the access mode. Only “ProBridge” is listed.
7. Under Start String, enter the desired transaction text, such as an ATM transaction number.
8. Click **Apply** to save the settings.

To search text insertion in recorded video:

1. In live view, check the **By text** check box.

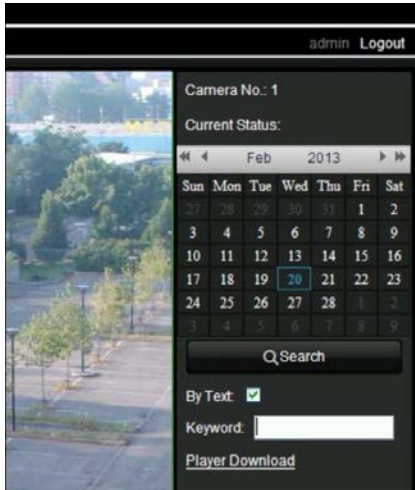

2. In the keyword text box that appears, enter the text for which you want to search.

Text overlay

You can add up to eight lines of text on screen via the browser. This option can be used, for example, to display emergency contact details. By default these lines of text are positioned along the top of the screen. The strings follow each other consecutively.

Note: This option is not available via the NVR.

To add on-screen overlay text:

1. Click the **Configuration** tab in the browser toolbar and then select **Camera Settings > Text Overlay**.
2. Select the desired camera.
3. Check the string box **1** for the first line of text.
4. Enter the text for string 1 in the column alongside. Up to 22 alphanumeric characters can be used.
5. Repeat steps 3 and 4 for each extra line of text, selecting the next string number.
6. Click **Save**.

Using a network storage system

You can use a network storage system (NAS) or storage area network (SAN) to remotely store NVR recordings.

To set up a network storage system:

1. Click the **Configuration** tab in the browser toolbar and then select **Network Settings > NetHDD**.
2. On the first line of **HDD No.**, enter the IP address of the desired remote storage system.
3. Enter the file path name to define where on the remote storage system you want to store the files.
4. Under **Type**, select type of storage system to be used: NAS or SAN. Default is NAS.
5. Up to eight remote storage systems can be set up.
6. Click **Save**.

Chapter 10

Recording

This chapter provides instructions on how to define the recording settings of your NVR. This chapter covers how you can configure your initial recording settings, schedule recordings, protect your recorded files, and set up your HDD for redundancy.

Enter menu mode by pressing the Menu button on the front panel or use the mouse menu to select Menu (see “Controlling live view mode” on page 28). See “Menu overview” on page 23 for a list of the menu icons.

Initializing recording settings

Before you can set up your NVR to begin recording, you must first configure general recording settings for the IP cameras.

Ensure that the HDD has been installed and initialized before configuring the recording settings. See Chapter 13 “HDD management” on page 109 for more information.

To configure recording settings:

1. Click the **Video Schedule** icon in the menu toolbar.
2. Select **Encoding > Record**.



3. Select the camera you want to configure.
4. Configure the following recording settings:
 - **Encoding parameters:** Select one of the stream types: Mainstream (TL-Hi), Mainstream (TL-Lo), Mainstream (Event), Mainstream (Alarm), or Substream.
 - **Stream type:** Select the type of stream to record, either video or video and audio.
 - **Resolution:** Select the resolution of the recording.
 - **Bit rate type:** Select Constant or Variable.
 - **Video quality:** Select the quality at which to record. If “Constant” was selected as the bit rate type, this option is unavailable.
 - **Frame rate:** Select the recording frame rate. 25 PAL (30 NTSC), 20, 18, 16, 15, 12, 10, 8, 6 (default), 4, 2, 1, 1/2, 1/4, 1/8, 1/16. Default is 25 (30).
 - **Max bit rate mode:** Select the general default or customized option.
 - **Max bit rate (kbps):** If the customized maximum bit rate mode was selected, enter the value here. It must be between 32 and 8192 kbps. It is calculated from the frame rate and time required.
 - **Pre-record:** This is the time the camera starts recording before the scheduled time or event. Select the time in seconds to start pre-recording before the scheduled time or event.

The maximum pre-recording times available depend on the constant bit rate. See “Maximum pre-recording times” on page 141 for more information.

- **Post-record:** This is the time the camera continues to record after the scheduled time or event. Select the time in seconds to stop post-recording after the scheduled time or event.
- **Auto-delete (day):** Select the number of days after which recorded video from the specified camera is permanently deleted from the HDD. A “day” is defined as the 24-hour period from when the auto delete mode (ADM) was set.

The maximum number of days that can be set is 60. However, the actual number of days permitted depends on the HDD capacity. If the value is set to '0', the option is disabled.

- **Record audio:** Select **Yes** to record sound with the images.
5. Click **Apply** to save the settings.
 6. Click the **Capture** tab and configure the settings for captured video, such as snapshots. Click **Apply** to save the settings.
 7. Click **Back** to return to live view.

Using an external recording device

You can use an external storage device, such as an eSATA HDD, to backup video or to add its recording capacity to that of the NVR itself. If you change this option, you must reboot the NVR to implement the change.

To define how the external recording device is used:

1. Click the **Video Schedule** icon in the menu toolbar.
2. Select **More Settings**.
3. Select one of the two options:

Record and Capture: Extend the recording capacity of the NVR.

Export: Backup data onto an eSATA backup device.

Note: If the external storage device is part of the total internal capacity of the NVR, then it is no longer available for backing up video.

4. Click **Apply**.

Configuring overwrite

You can select how the NVR responds when the HDDs become full and there is no longer sufficient space to save new data.

To configure for overwrite when the HDDs are full:

1. Click the **Video Schedule** icon in the menu toolbar.
2. Select **More Settings**.
3. Under **Overwrite**, select **Yes**.

Defining a recording schedule

Defining a recording schedule lets you specify when the NVR records video and under what circumstances. Each camera can be configured to have its own recording schedule.

The schedules are visually presented on a map for easy reference. See Figure 33 below for an example.

Figure 33: Description of the Schedule screen



1. **Camera.** Select a camera.
2. **Schedule time.** Represents the 24-hour cycle during which a schedule is selected.
3. **Schedule day.** There are seven days to select: Sunday (Sun), Monday (Mon), Tuesday (Tue), Wednesday (Wed), Thursday (Thu), Friday (Fri), and Saturday (Sat).
4. **Recording type.** There are five recording types to select, which are color-coded:
 - TL Time lapse (Green squares): Record of a specific day. Each green square in the timeline represents an hour in the 24-hour period.
 - TL-Hi (Dark green): High quality time lapse. Records high quality video.

- TL-Lo (Bright green): Low quality time lapse. Records low quality video. This could be used, for example, for night recordings when few events or alarms are expected. Saving the video in low quality helps save resources on the HDD.
 - Event (Yellow): Records only events, such as motion detection and POS/ATM text insertion.
 - Alarm (Red): Records only alarms.
 - None (Grey): No recording during this period.
5. **Timeline.** There is a 24-hour time line for each day. Up to eight recording periods can be scheduled during the 24-hour period.

Daily schedules

To set up a daily recording schedule:

1. Click the **Video Schedule** icon in the menu toolbar and select **Schedule**.
2. Select a camera.
3. Check the **Enable Schedule** box.
4. Click **Edit**. The following screen is displayed ((by default, **All Day** is selected):

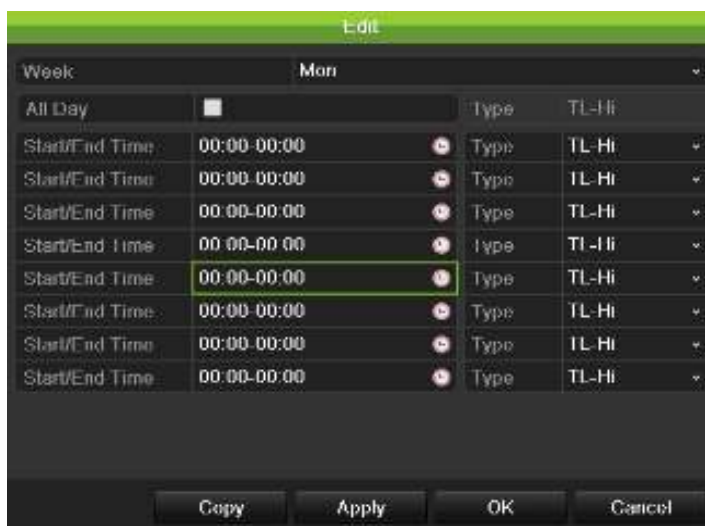

5. Select the day of the week for which you want to set up the schedule.
You can define a schedule for each day of the week.
6. Set the start and end time for recording.
Define a time period by entering a start (left column) and end (right column) time. You can schedule up to eight time periods. Click All Day to record all day.
Note: Time periods defined cannot overlap.
7. Select a recording type.
This setting instructs the NVR to begin recording when an alarm is triggered. The recording type can be based on time and triggered by motion detection

and/or an alarm. If set to TimeLapse (TL-Hi or TL-Lo), the NVR records continuously.

8. Click **Apply** to save settings
9. Repeat steps 3 to 8 for other days of the week or to copy the schedule settings to another day.

To copy the current schedule settings to another day of the week, click **Copy**. Select the number of the day of the week to which to copy the schedule and click **OK** to save changes and return to the Edit screen.

10. Repeat steps 3 to 9 for other cameras.
11. Click **Apply** to save the settings and then **OK** to return to the schedule screen.

Holiday schedules

As well as being able to schedule when recordings occur during the week, you can also schedule them for specific holidays in the year such as the first of January, or the second Wednesday of every month. You can schedule up to 32 holiday periods.

A holiday period can be scheduled for a particular day or as a block of days.

To set up a holiday recording schedule:

1. Click the **Display Mode Settings** icon in the menu toolbar and select **Holidays**.
2. Select a holiday period from the list and click **Edit** to modify the settings. The Edit screen appears.

Edit	
Holiday Name	Holiday1
Enable	<input type="checkbox"/>
Mode	By Month
Start Date	Jan 1
End Date	Jan 1

3. Enter the name of the holiday period and click **Enable**.
4. Select whether the holiday period will be categorized by date, week or month and then enter the start and end dates.

5. Click **Apply** to save the settings and then **OK** to return to the Edit screen.
6. Repeat steps 2 to 5 for other holiday periods.
7. Click **Back** to return to live view.

Motion detection schedules

For IP cameras you can configure from the NVR the schedule when the camera can be triggered by motion. However, you need to configure the area of the video display sensitive to motion from the camera itself.

For information on scheduling motion detections, see “Motion detection set up” on page 92.

External alarm schedules

The NVR can be scheduled to record when an alarm is triggered by an external alarm device such as a PIR detector or dry contacts. For information on scheduling external alarms, see “Triggering or clearing alarm outputs manually” on page 96.

Protecting recorded files

There are two methods to prevent recorded files from being inadvertently overwritten or deleted off the HDD. We highly recommend that important recorded events be protected from deletion. Recorded files can either be *locked* or the HDD that the files reside on can be set to *read only*.

Locking and unlocking recorded files

Lock files to protect them against being overwritten or deleted.

To lock or unlock a recorded file:

1. In live view enter the video search screen by pressing the **Search** button on the front panel or remote control, and then enter **Advanced Search**.

— Or —

In live view right-click the mouse to display the pop-up menu and select **Advanced Search**.

The Search screen appears.

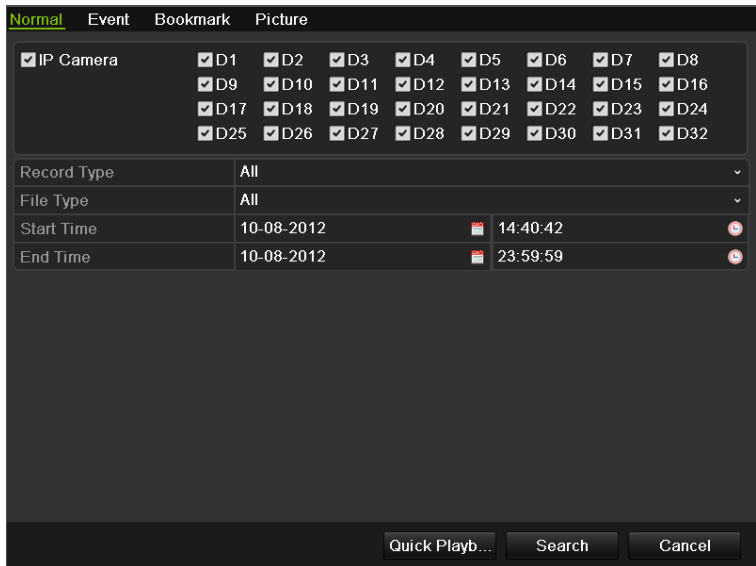

2. Search for the desired recording by entering the search parameters, which include the camera number, record type, file type, and start time and end time.
3. Click **Search**.

A list of recordings, similar to the figure below, matching the search parameters is displayed.

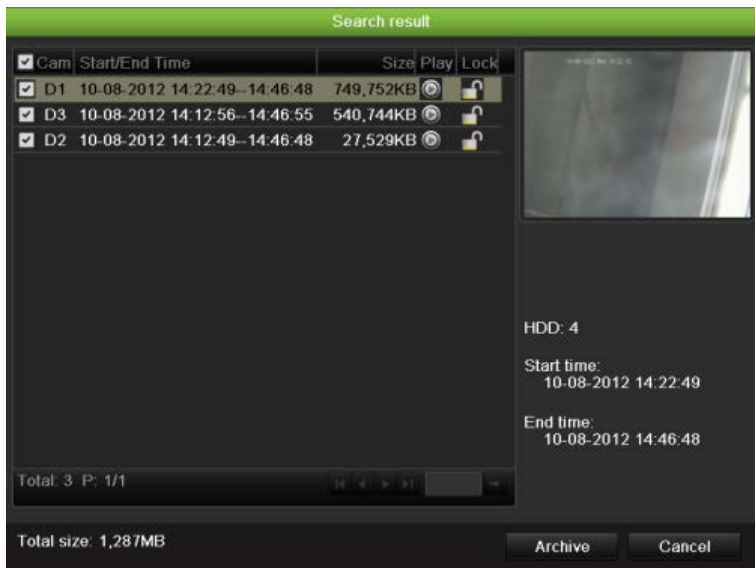

4. Select the file you want to lock/unlock.
5. Click to lock a file. Click again to unlock.

The Locked column indicates whether a file is locked or not. Closed lock icons indicate locked files while opened lock icons indicate unlocked files. The Lock button toggles between Lock and Unlock, depending on the file.

6. Click **Cancel** to return to live view.

Setting the HDD to read-only

When you set an HDD to *read-only*, recorded video files cannot be written to the HDD. If multiple HDDs are used, the NVR automatically records to the next HDD not set to *read-only*.

To set a HDD to read-only:

1. Click the **System Setting** icon in the menu toolbar.
2. Click **Hard Disk** to set up the HDD parameters.
3. Select the HDD you want to set to read-only.
4. Check **Read only**.
5. Click **Apply** to save the settings. The HDD is now read-only.

Note: In order to enable recordings on that particular HDD again, you must set the HDD status back to R/W (Read/ Write).

Configuring redundant recording

Setting up HDD redundancy lets your NVR redundantly record a copy of the videos onto multiple drives as a safeguard against losing all your files in case of disk failures. This process is also known as *mirroring*. You must have more than one HDD in your NVR to set up HDD redundancy.

Redundancy significantly reduces the storage capability of the HDDs. As a result you need to double your capacity to record video over a given time.

Note: You must set the storage mode of the HDD to Group before configuring the redundancy. See “Setting up HDD groups” on page 110 for more information.

To set up HDD redundancy:

1. Click the **System Setting** icon in the menu toolbar and select **Hard Disk**.
2. Click the **HDD Information** tab and select the HDD to be used for redundancy and click **Edit**.



3. In the Local HDD Settings screen, select **Redundancy**.
Verify at least one other HDD is set to R/W (read/write).
4. Click **Apply** to save the settings and then **OK** return to the previous screen.

5. In the menu toolbar, click the **Video Schedule > Encoding**.
6. Select the camera to be used for redundancy.
7. Check **Redundant Record/Capture**.
8. Click **Apply** to save the settings.
9. Repeat steps 7 to 9 for other cameras whose files you would like to be redundantly recorded.
10. Click **Back** to return to live view.

Note: The HDD set to redundancy stores an extra copy of the recording. When an HDD is set to redundancy, at least one other HDD must be set to the R/W status.

Capturing text insertions

The NVR supports Point-of-Sale (POS) and ATM text insertion via the UTC ProBridge accessory connected to the RS-232 port on the NVR.

The feature is currently only available via the browser (see “Capturing text insertions” on page 76).

Chapter 11

Alarm settings

This chapter describes setting up how the system will respond when an alarm is triggered.

Description of alarm notification types

When setting up the rules for alarm detection, you can specify how you want the NVR to notify you about an alarm or event. You can select more than one notification type. Not all notification types are available for all types of alarms.

The alarm notification types are:

- **Audible warning:** Triggers an audible *beep* when a notification or alarm is detected.
- **Notify surveillance center:** Sends a signal to TruVision Navigator or other software applications when an alarm or notification is detected.
- **Trigger alarm output:** Triggers an alarm output when a notification is detected for an external alarm. See “Setting up external alarms” on page 94 for information on configuring an alarm output.
- **Send e-mail:** Sends an e-mail when an alarm or notification is detected. See “Configuring e-mail” on page 103 for information on how to configure the NVR to send an e-mail.
- **Full screen monitoring:** When an alarm is triggered, the local spot monitor (VGA or BNC monitor) displays an image in live view mode. For alarms that are triggered simultaneously, images display one at a time every 10 seconds (default dwell time). You can set a different dwell time using the Dwell Time setting under the Display Settings>Layout screen. When the alarm stops, cycling of the images stops and you return to live view mode. This alarm option must be selected for each channel where it is required..

This alarm notification is not available for system alarms.

Setting up motion detection

Motion detection is one of the most important features of a NVR. With it there is no need to manually search through hours of video recordings to find an event. The NVR can be set up to trigger an alarm if it detects motion and to record it. You can then search these recorded motion activities for specific incidents. If enabled, motion detection recording can help increase the number of days your NVR can record.

You can mask out any areas of motion on an IP camera display that you do not want to trigger a recording such as a flag on a pole or a moving tree.

Select the level of sensitivity to motion.

You can set up the schedule from the NVR when the camera can be triggered by motion. However, you need to configure the area of the video display sensitive to motion from the IP camera itself.

Motion detection set up

To set up motion detection:

1. Click the **Camera Management** icon in the menu toolbar and select **Motion**.

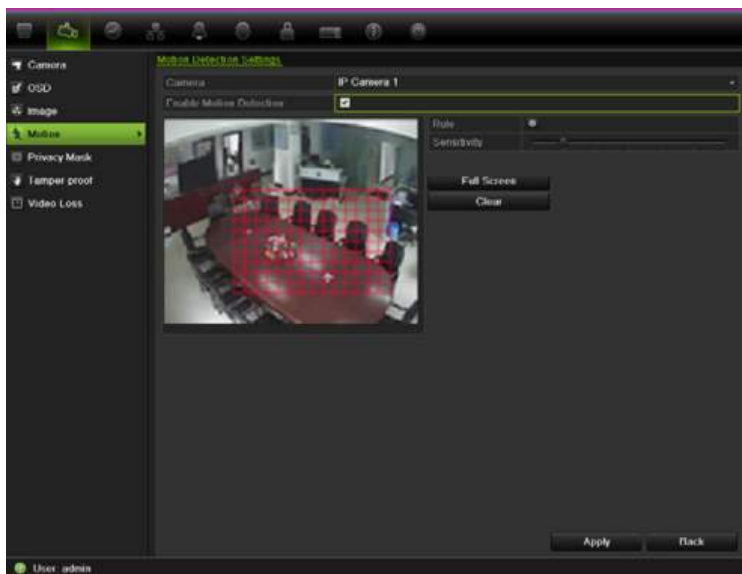

2. Select the IP camera to detect motion. Each camera must be set up individually.
3. Check **Enable Motion Detection**.
4. Select the areas sensitive to motion.

Click and drag the mouse cursor across the screen. The area selected appears as a red grid. Areas covered by the red grid are sensitive to motion detection.

Click **Full screen** to activate the whole screen or **Clear** to clear the screen.

Note: The motion grid is sensitive to motion during configuration.

5. Set the sensitivity level.

Drag the Sensitivity scroll bar to the desired sensitivity level. The highest value is on the right of the bar.

6. Select the cameras that will record the motion detected.

Click **Rule**. The Rule screen appears. Click the **Trigger Channel** tab and select the cameras that will record when a motion alarm is triggered. Click **Apply** to save the settings.

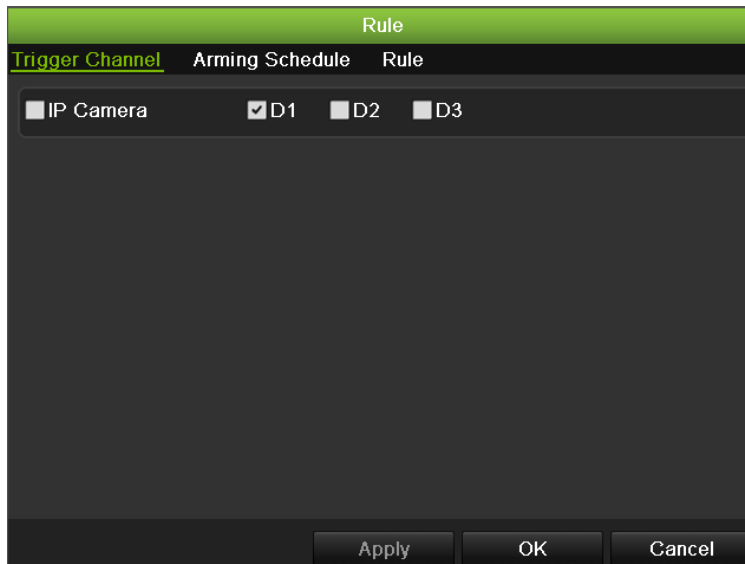

7. Select the recording schedules for motion detection.

Click the **Arming schedule** tab and select the day of the week and the time periods during the day when motion can be recorded. You can schedule up to eight time periods in a day. Default is 24 hours.

Click **Apply** to save the settings. Click **Copy** to copy the settings to other days of the week.

Note: Time periods defined cannot overlap.

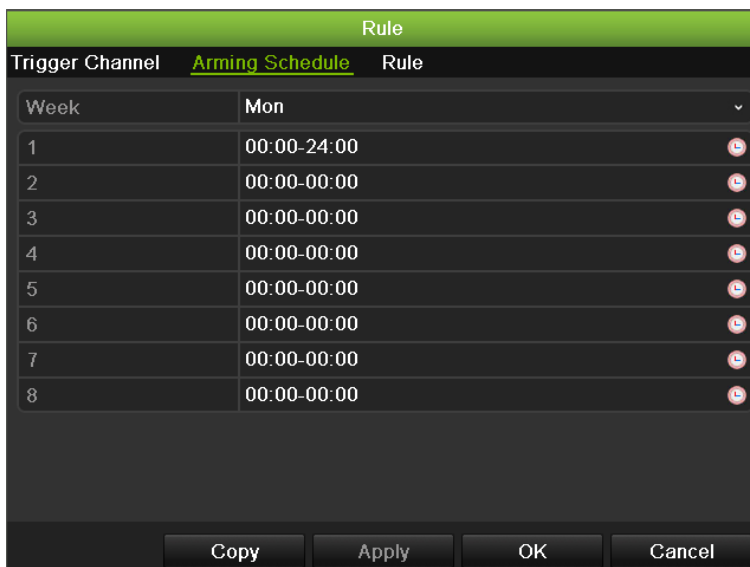

8. Select the response method to motion detection.

Click the Rule tab to define the method by which you want the NVR to notify you of the alarm. Click **Apply** to save settings.

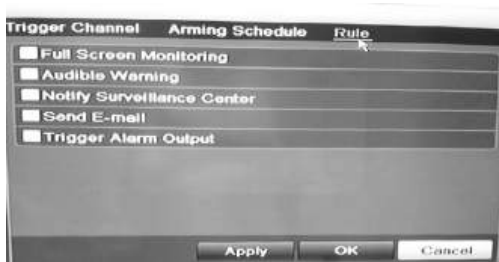

9. Click **OK** to return to the motion detection settings screen.
10. Click **Back** to return to live view.

Setting up external alarms

The NVR can be configured to record when an alarm is triggered by an external alarm device (for example, PIR detector, dry contacts, etc.).

To set up external alarms:

1. Click the **Alarm settings** icon in the menu toolbar and select **Alarm Input**.

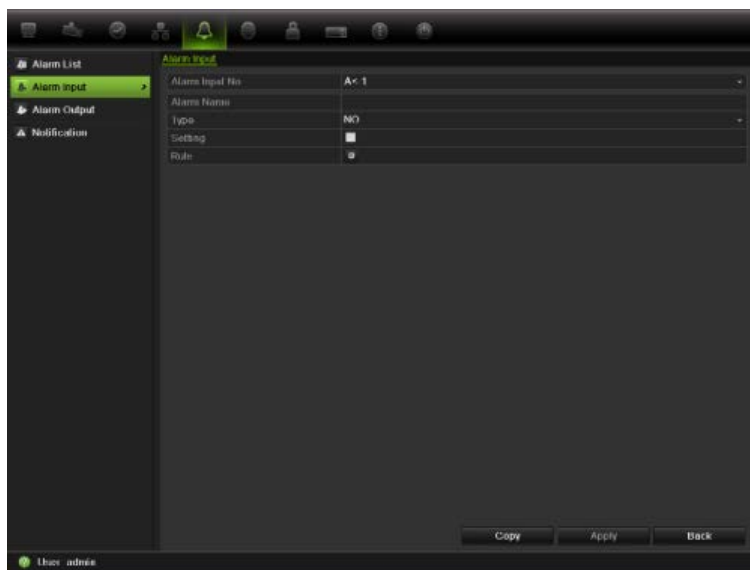

2. Select the alarm input number of a camera and enter the name of the input, if required.
3. Select the alarm input type, NO or NC.
4. Check the Setting box to enable the function and click **Rule** to set up the rules for the cameras to be triggered, their alarm schedules, method of alarm notification and PTZ function.
5. Select the cameras to be triggered when an external alarm is detected.

In the Rule window, click **Trigger channel** and select the cameras to be triggered for recording when an alarm is detected. Click **Apply** to save the settings.

6. Select the recording schedules for the external alarm.

Click the **Arming schedule** tab and select the day of the week and the time periods during the day when motion can be recorded. You can schedule up to eight time periods in a day. Default is 24 hours.

Click **Apply** to save the settings. Click **Copy** to copy the settings to other days of the week and holiday period.

Note: The time periods defined cannot overlap.

7. Select the response method to an external alarm.

Click the Rule tab to define the method by which you want the NVR to notify you of the alarm. Click **Apply** to save settings.

8. Select the PTZ camera function required in response to an external alarm.

Select the PTZ camera and the preset, preset tour or shadow tour that is triggered when the alarm is detected.

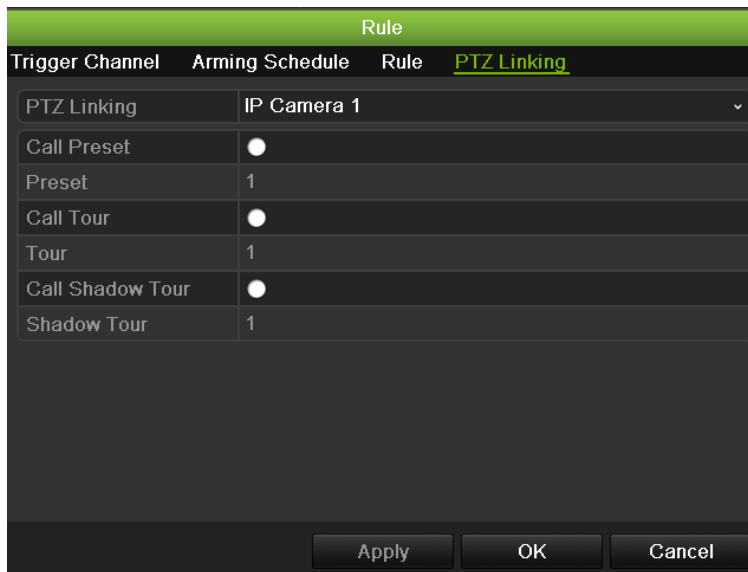

Click **Apply** to save the settings. Click **Copy** to copy the settings to other cameras, if required.

9. Click **OK** to return to the alarm input screen.
10. Click **Back** to return to live view.

To set up an alarm output:

Note: Not all IP cameras can be triggered by an alarm output.

1. Click the **Alarm Settings** icon in the menu toolbar and select **Alarm Output**.
2. Select the alarm output.
3. Select a timeout option.

The timeout setting lets you define how long a signal remains active after the alarm has ended.

4. Select the arming schedules for the alarm output.

Click **Rule** and select the day of the week and the time periods during the day when alarm outputs can be detected. You can schedule up to eight time periods in a day. Default is 24 hours.

Click **Apply** to save the settings. Click **Copy** to copy the settings to other days of the week and holiday period.

Note: The time periods defined cannot overlap.

5. Click **OK** to return to the alarm output screen.
6. Click **Back** to return to live view.

Triggering or clearing alarm outputs manually

When an alarm is activated, the NVR can be set up so that the alarm must be manually acknowledged in order to be silenced. See “Setting up external alarms” on page 94 for information on setting up an alarm to be manually cleared.

All user levels (administrator, manager and operator) can manually acknowledge an alarm.

To trigger or clear alarm outputs manually:

1. Click the **Alarm settings** icon in the menu toolbar and select **Alarm Output**.
2. Click the **Manual Alarm** tab.
3. Select the desired alarm output and click one of the following buttons:
 - **Clear:** Clear to stop alarm output.
 - **Trigger All:** Trigger all alarm outputs at once. This action could be done, for example, when you need to test them.
 - **Trigger:** Trigger the selected alarm output manually.
 - **Clear All:** Stop all alarm outputs at once.
4. Click **Back** to return to live view. The alarm is silenced.

Setting up system notifications

Setting up system notifications instructs the NVR to alert you when irregular events occur and how to alert you to the event.

You can quickly check the system status by looking at the status LEDs on the front panel. When there is an irregular event with the system, an icon appears on

screen to also alert you. See “Status information” on page 27 for further information.

The system notifications include:

- **HDD Full:** All installed HDDs are full (overwrite option is disabled).
- **HDD Error:** Errors occurred while files were being written to the HDD, no HDD installed or HDD had failed to initialize.
- **Network Disconnected:** Disconnected network cable.
- **IP Conflicted:** Conflict in IP address setting.
- **Illegal Login:** Wrong user ID or password used.
- **Abnormal Record:** Recording failed due to encoder or HDD problems.

See “Description of alarm notification types” on page 91 for information on the different alarm notification types available.

To set up system notifications:

1. Click the **Alarm settings** icon in the menu toolbar and select **Notification**.
2. Select a notification type. See “Description of alarm notification types” on page 91 for more information.
3. Check one or more response options: Audible warning, notify surveillance center, send e-mail, trigger alarm output.
4. Click **Apply** to save the settings.

Detecting video loss

Video may be lost if the video cable or camera develop a fault or are damaged. You can set up the NVR to detect video loss and trigger a system notification.

To setup video loss detection:

1. Click the **Camera management** icon in the menu toolbar and select **Video Loss**.
2. Select a camera to configure for video loss detection.
3. Check the **Enable Video Loss Alarm** box to enable the feature.
4. Click **Rules** next to the Video Loss Detection box to enter the Rules screen.
5. Click the **Rule** tab and select how you want the NVR to notify you of video loss. Click **Apply** to save the settings and then click **OK** to return to the previous screen.
6. Click the **Arming Schedule** tab and select the schedule of when you want video loss detection to be enabled. Schedule can be set for all week or any day of the week with up to 8 time periods per day.
7. Click the **Apply** button to save settings.

8. Click **Back** to return to live view.

Detecting video tampering

Video tampering, such as moving a camera to a different position, can also be detected and set to trigger an action on the NVR.

Only IP cameras can be selected. However, not all IP cameras may support this feature.

Note: It is strongly recommended not to configure for video tampering when using PTZ dome cameras.

To set up video tampering detection:

1. Click the **Camera management** icon in the menu toolbar and select **Tamper-Proof** to display the tamper-proof settings screen.
2. Select a camera to configure for tamper-proof.
3. Check the **Enable Tamper-proof** box to enable the feature.
4. Define a tampering area.

The tamper detection area setup interface lets you define an area on screen where you want camera tampering to be detected. Click and drag the mouse across an area to mark that area for video tampering. You can only set one tampering area with the full screen being the maximum area. Click **Clear** to clear the screen.

5. Select the tamper detection sensitivity level by clicking the sensitivity scroll bar. Higher sensitivity is to the right of the bar.
6. Select the arming schedules for the tamper.

Click **Rule** and then select the **Arming schedule** tab to select the day of the week and the time periods during the day when tamper can be detected. You can schedule up to eight time periods in a day. Default is 24 hours.

Click **Apply** to save the settings. Click **Copy** to copy the settings to other days of the week and holiday period.

Note: The time periods defined cannot overlap.

7. Select the response method to an external alarm.

Click **Rule** and then select the **Rule** tab to select the method by which you want the NVR to notify you of the alarm. Click **Apply** to save settings and then **OK** to return to the previous screen.

8. Click **Back** to return to live view.

Chapter 12

Network settings

You must configure your NVR's network settings before using it over the network. The NVR must have access to the internet when configuring the network settings.

Note: As every network configuration may differ, please contact your Network Administrator or ISP to see if your NVR requires specific IP addresses or port numbers.

Configuring general network settings

To configure general network settings:

1. Click the **Network settings** icon in the menu toolbar to display its screen.

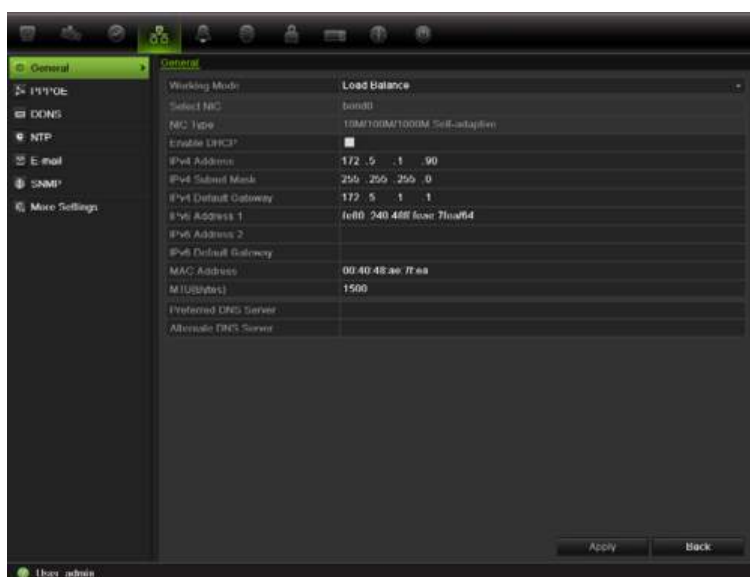

2. Click **General** and enter the required settings:

Option	Description
Working mode	<p>The NVR has two 10M/100M/1000M NIC cards that support net fault tolerance, load balance, and multi-address modes. Select one of the options:</p> <p>Net fault tolerance: When one LAN port fails, the other one takes over. This is the default option.</p> <p>Load balance: The bandwidth is divided over the two LAN ports with one IP address.</p> <p>Multi-address: Each LAN port is separate with its own IP address. This allows one LAN port for the IOP cameras and the other for client PCs such as TruNav.</p>
Select NIC	Select which LAN port is being defined.
NIC type	<p>Network interface card (NIC) is a device used to connect the NVR to a network. Select the NIC type used from the drop-down list.</p> <p>Default value is 10/100/1000M self-adaptive.</p>
Enable DHCP	<p>Check this box if you have a DHCP server running and want your NVR to automatically obtain an IP address and other network settings from that server.</p> <p>Default value is Enable.</p>
IPv4 address	<p>Enter the IP address for the NVR.</p> <p>Default value is 192.168.1.82.</p>
IPv4 subnet mask	<p>Enter the subnet mask for your network so the NVR will be recognized within the network.</p> <p>Default value is 255.255.255.0</p>
IPv4 default gateway	<p>Enter the IP address of your network gateway so the NVR will be recognized within the network. This is typically the IP address of your router.</p> <p>Default value is 192.168.1.1</p>
IPv6 address 1	<p>Enter the IPv6 address for the NVR.</p> <p>Default value is fe80::240:30ff:fe48:2975/64.</p>
IPv6 address 2	Enter the IPv6 address for the NVR.
IPv6 default gateway	<p>Enter the IPv6 address of your network gateway so the NVR will be recognized within the network. This is typically the IP address of your router.</p>
MAC address	Enter the MAC address.
MTU (bytes)	Enter a value between 500 and 9676. Default is 1500.
Preferred DNS server	Enter the preferred domain name server to use with the NVR.
Alternate DNS server	Enter the alternate domain name server to use with the NVR.
Main NIC (or Default route)	<p>Select the main LAN port when net fault tolerance or load balance mode is selected. LAN I is default.</p> <p>Select which LAN is the main route when multi-address mode is selected.</p>

3. Click **Apply** to save the settings.

Configuring PPPoE

You can connect the NVR directly to a DSL modem. To do this, you need to select the PPPoE option in the network settings. Contact your ISP to get the user name and password.

To configure general network settings:

1. Click the **Network settings** icon in the menu toolbar to display its screen.
2. Click **PPPoE** and check the enable PPPoE box.
3. Enter your user name and password and confirm the password.
4. Click **Apply** to save the settings.

Configuring DDNS

If your NVR is set up to use PPPoE as its default network connection, you can set up Dynamic DNS (DDNS) to be used in conjunction. You need to register with your ISP before configuring your system for use with DDNS.

There are two ways to set up a DDNS:

- **DynDNS:** Manually create your own host name. You will first need to create a user account using the hosting web site, DynDDNS.org.
- **ezDDNS:** Activate the DDNS auto-detection function to set up a dynamic IP address. The server is set up to assign an available host name to your NVR.

Figure 34: ezDDNS setup window

NAT translates the ports on the server. Consequently there is no need to remember the ports when connecting to the unit from the internet



Internal ports

External ports. These values can be modified to access several units over the internet

Note: This option is not shown when using the browser.

To set up DDNS:

1. Click the **Network settings** icon in the menu toolbar.
2. Click **DDNS** to display its screen.
3. Check the **DDNS** box to enable feature.
4. Select one of the DDNS types listed:
 - **ezDDNS:** Click the **Get URL** button. The URL address to access the unit is then displayed. If no host name is specified, the DDNS will allocate one automatically. Check the NAT box to enable this option and enter the NAT server port and NAT HTTP port values.
 - **DynDNS:** Enter the server address for DynDNS (i.e. members.dyndns.org). In the NVR domain name field, enter the domain obtained from the DynDNS web site. Then enter the user name and password registered in the DynDNS network.
5. Click **Apply** to save the settings.

Configuring an NTP server

A Network Time Protocol (NTP) server can also be configured on your NVR to keep the date and time current and accurate.

Note: If the device is connected to a public network, you should use a NTP server that has a time synchronization function, such as the server at the National Time Center (IP Address: 210.72.145.44) or europe.ntp.pool.org. If the device is setup in a more customized network, NTP software can be used to establish a NTP server used for time synchronization.

To set up an NTP server:

1. Click the **Network settings** icon in the menu toolbar.
2. Click **NTP** to display its screen.
3. Check the NTP box to enable feature. It is enabled by default.
4. Enter the NTP settings:
 - **Interval:** Time in minutes to synchronize with the NTP server. The value can be between 1 and 65535 minutes. Default is 60 minutes.
 - **NTP server:** IP address of the NTP server.
 - **NTP port:** Port of the NTP server.
5. Click **Apply** to save the settings.

Configuring e-mail

Your NVR can send e-mail notifications of alarms or notifications through the network.

Note: Ensure that the DNS address has been set up correctly beforehand.

To configure e-mail settings:

1. Click the **Network Settings** icon in the menu toolbar.
2. Click **E-mail** and enter the required settings.

Option	Description
Enable server authentication	Check the box if your mail server requires authentication and enter the login user name and password.
SMTP server	Enter the SMTP server's IP address.
SMTP port	Enter the SMTP port. The default TCP/IP port for SMTP is 25.
Enable SSL	Check the box to enable SSL if it is required by the SMTP server. This feature is optional.
Sender	Enter the name of the sender of the e-mail.
Sender's address	Enter the sender's e-mail address.
Select receivers	Select an e-mail recipient. Up to three receivers can be selected.
Receiver	Enter the name of the receiver of the e-mail.
Receiver's address	Enter the e-mail address of the receiver.
Enable Attached Picture	Check the Enable Attached Picture box if you want to send an e-mail with attached alarm images.
Interval	Select an interval range in the Interval box. The interval range represents the time range between the alarm images being sent. For example, if you set the interval range at two seconds, the second alarm image will be sent two seconds after the first alarm image.

3. Click **Test** to the test e-mail settings.

Note: We recommend that you test the e-mail settings after entering values in the e-mail window.

4. Click **Apply** to save the settings.

Configuring SNMP

SNMP is a protocol for managing devices on networks. When you enable SNMP in the menu, network management systems can retrieve NVR status information from the NVR via SNMP.

When you set the trap address and trap port in the NVR menu to the network management system's IP address and port number, and set up the network management system as trap receiver, trap notifications (such as startup) are sent

from the NVR to the network management system.

Before configuring this function, you must first install the SNMP software.

To configure SNMP protocol settings:

1. Click the **Network settings** icon in the menu toolbar.
2. Click **SNMP** and enter the required settings.
3. Click **Apply** to save the settings.

Configuring the FTP server

This function is currently unavailable.

Configuring a remote alarm host

If a remote alarm host is set, the NVR sends a signal to the host when an alarm is triggered. The remote alarm host must have the TruVision Navigator server software installed.

To set up a remote alarm host:

1. Click the **Network Settings** icon in the menu toolbar.
2. Click **More Settings**.
3. Enter Alarm Host IP and Alarm Host Port.

Alarm host IP represents the IP of the remote PC where the Network Video Surveillance software installed. The alarm host port value must be the same as software's alarm monitor port. Default port is 7200.

Configuring multicast

Setting up multicasting resolves limitation issues when streaming videos through a network access device. A multicast address spans the Class-D IP range of 224.0.0.0 to 239.255.255.255. We recommend that the IP address range of 239.252.0.0 to 239.255.255.255 be used.

To set up multicasting:

1. Click **Network Settings** icon in the menu toolbar and then click **More Settings**.
2. Enter a Multicast IP address.

Note: When adding a device to the Network Video Surveillance software, the multicast address must be the same as the NVR's multicast IP.

3. Click **Apply** to save the settings.

Configuring the server and HTTP ports

You can change the server and HTTP ports from the default settings in the Network Settings screen. The default server port is 8000 while that of the default HTTP port is 80.

Note: The server port has a port range of 1024 to 65535 and is used for remote client software access. The HTTP port is used for remote internet browser access.

To change the default ports:

1. Click the **Network Settings** icon in the menu toolbar and then click **More Settings**.
2. Enter the new Server Port and HTTP Port values.

Configuring the RTSP service port

The RTSP (Real Time Streaming Protocol) is a network control protocol designed for use in entertainment and communications systems to control streaming media servers.

To configure RTSP service port:

1. Click the **Network Settings** icon in the menu toolbar and then click **More Settings**.
2. Enter the RSTP port value. The default value 554.

Checking network status

You can easily check network traffic in order to obtain information about the NVR such as its linking status, MTU, sending/receiving rate, MAC address, and NIC type.

You can also check the network connection status by testing its delay and packet loss.

To check network traffic:

1. Click the **System Settings** icon in the menu toolbar and then click **Net detect** to display the Traffic screen. The information displayed is refreshed once a second.



To check network delay and packet loss:

1. Click the **System Settings** icon in the menu toolbar and then click **Net detect**.
2. Select the **Network Detection** tab.
3. Under the section “Network delay, Packet loss test”, enter the destination address and click **Test**.

The test result appears in a pop-up screen.

4. If you need to check the current network parameters, click the **Network** button to get an overview.

To check network statistics:

1. Click the **System settings** icon in the menu toolbar and then click **Net detect**.
2. Select the **Network Stat.** tab.
3. The latest information is displayed on the bandwidth used by remote live and playback as well by Net Receive Idle and Net Send Idle. Click **Refresh** to update the information.

Exporting network packet data

When the NVR is connected to a network, you can export the captured data packet to a USB-flash disk, SATA/eSATA CD-RW and other local backup devices.

To export network packet data:

1. Click the **System Settings** icon in the menu toolbar and then click **Net detect**.
2. Select the **Network Detection Status** tab.
3. Under the section “Network packet export”, click **Refresh** to get a list of the local backup devices available. Select one from the list.
4. Click **Export**. Up to 1M of data can be exported at a time.

Port forwarding

When using an internet connection, make sure that ports are open or forwarded, as follows:

- **When using TruNav:** Port 8000 and 554
- **When using a web browser:** Port 80 and 554

See “Appendix C “Port forwarding information” on page 141 for more information.

Chapter 13

HDD management

Initializing HDDs

The in-built HDD must be initialized before it can be used. You can also re-initialize the HDD. However, all data on the HDD will be destroyed.

To initialize a HDD:

1. Click the **System Settings** icon in the menu toolbar and then click **Hard Disk** to display its screen.
2. Select the HDD to be initialized.
3. Click the **Initialize** button to begin initialization.

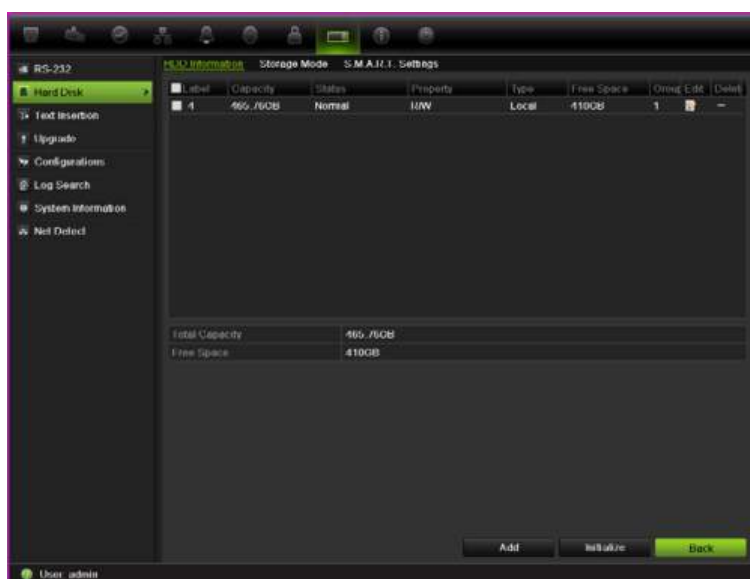

After the HDD has been initialized, the status of the HDD changes from Abnormal to Normal.

Controlling disk space on the HDD

You can allocate on a HDD the maximum permitted storage and snapshot capacities from each camera.

1. Click the **System Settings** icon in the menu toolbar and then click **Hard Disk**.
2. Click the **Storage mode** tab.
3. Under the Mode option, select **Quota**.
4. Select a camera whose storage capacity you want to change and enter the values in GB for maximum record capacity and maximum picture capacity. The maximum storage capacity of the HDD is listed.
5. Click **Apply** to save the settings.
6. If you want to copy these values to other cameras, click **Copy** and select the cameras. Click **OK**. Click **Apply** to save the settings.

Setting up HDD groups

Your NVR can organize multiple HDDs into groups. Videos from specified channels can be set to be recorded onto a particular HDD group. You could, for example, save the records from a couple of high priority cameras to one HDD, and save the recordings from all the other cameras to another HDD.

To set up a HDD group:

1. Click the **System Settings** icon in the menu toolbar and then click **Hard Disk**.
2. Select the **Storage Mode** tab.

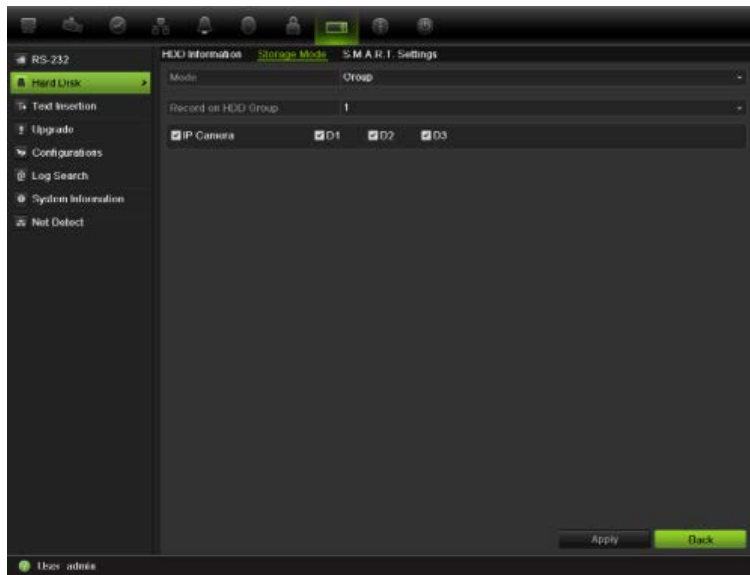

3. Under **Mode**, select **Group**.
4. Under **Record on HDD Group**, select the HDD group number.
5. Check the channels to be added to this group.
Note: By default, all channels belong to HDD group 1.
6. Click **Apply** to save the settings.

Setting the HDD property

You can change the behavior of your HDD by changing its property. It can be set to redundancy, read-only or read/write (R/W).

A HDD can be set to read-only to avoid important recorded files from being overwritten when the HDD becomes full.

Before changing the HDD property to “Redundancy”, there must be at least two HDDs installed in the NVR, you need to set the storage mode to “Group” and one of the other HDDs must be set to R/W. See “Setting up HDD groups” on page 110 for more information.

To change a HDD status property:

1. Click the **System Settings** icon in the menu toolbar and then click **Hard Disk**.
2. Click the **HDD Information** tab.
3. Select the HDD whose property you want to change.
4. Click the **Edit** icon . The Local HDD Settings screen appears.
5. Click the desired HDD property for the selected HDD.
6. Click the group number for this HDD.
7. Click **Apply** to save and exit the screen.

Note: Once set to read-only, the HDD cannot be used to save recorded files until it is set back to read/write (R/W). If the HDD that is currently being written to is set to read-only, the data is then recorded to the next HDD. If there is only one HDD present, setting it to read-only means the NVR cannot record.

Checking HDD status

You can check the status of any of the installed HDDs on the NVR at anytime.

To check the status of a HDD:

1. Click the **System Settings** icon in the menu toolbar and then click **Hard Disk**.
2. Note the status of the HDDs listed under the Status column.

If the status is listed as Normal or Sleeping, the HDD is in working order. If it is listed as Abnormal and has already been initialized, the HDD needs to be replaced. If the HDD is Uninitialized, you need to initialize it before it can be used in the NVR. Refer to “Initializing HDDs” on page 109 for more information.

Note: This information is also available under **System Settings > System Information > HDD** screen.

Configuring HDD alarms

HDD alarms can be set to trigger when an HDD is uninitialized or in an abnormal state.

To set HDD alarms:

1. Click the **Alarm settings** icon in the menu toolbar and select **Notification**.
2. Select the notification event to configure under Notification Type box.
3. Select **HDD Full** and check the desired notification method. See “Description of alarm notification types” on page 91 for more information.
Select **HDD Error** and check the desired notification method.
4. Click **Apply** to save the settings.

Managing eSATA

If you are using an external e-SATA device connected to the NVR, you can configure the e-SATA to record/capture or export video.

Select the Export option when using the eSATA as a backup. See “Using Quick Archive” on page 61 for further information.

Select the Record/Capture option to record and capture video. Information on the eSATA for this purpose can be seen under **System settings > Hard Disk > HDD Information**.

To set up the e-SATA device:

1. Click the **Video Schedule** icon in the menu toolbar and select **More Settings**.
2. Under **eSATA**, select the desired option: **Record/Capture** or **Export**.
3. Click **Apply** to save the settings.

Checking the S.M.A.R.T. information

S.M.A.R.T. (Self-Monitoring, Analysis and Reporting Technology) reports on a variety of hard drive attributes. It helps ensure that the HDD is functioning properly at all times while protecting video stored on the hard drive.

To view the S.M.A.R.T. information of a HDD:

1. Click the **System Settings** icon in the menu toolbar and then click **Hard Disk**.
2. Select the **S.M.A.R.T.** tab to display its screen.
3. Select the HDD whose data you want to see. A detail listing of S.M.A.R.T. information is displayed.

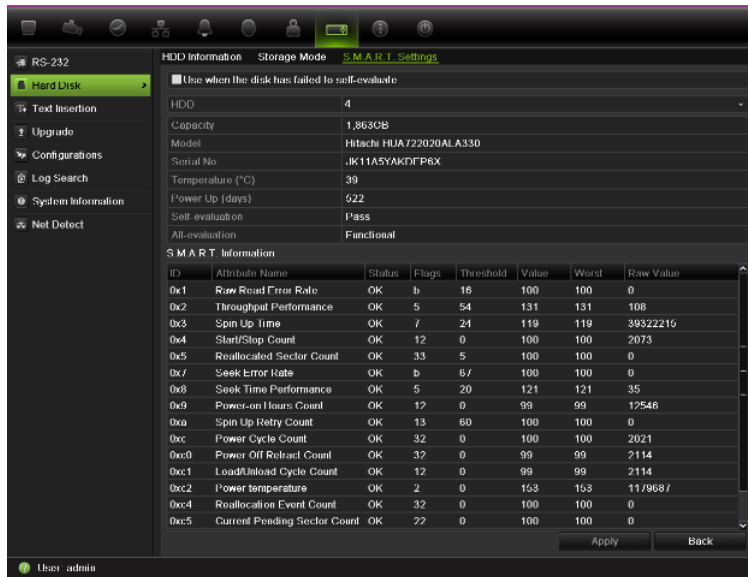

- If you want to continue to use a HDD when the S.M.A.R.T. test has failed, check the box **Use when the disk has failed to self-evaluate**. Click **Apply** to save the settings.

Chapter 14

Camera settings

The TVN 50 can support up to 32 network cameras.

Adding/removing IP cameras

Before adding an IP camera to the NVR system, it is important that the network settings of the NVR are correctly set up.

Figure 35: IP camera window

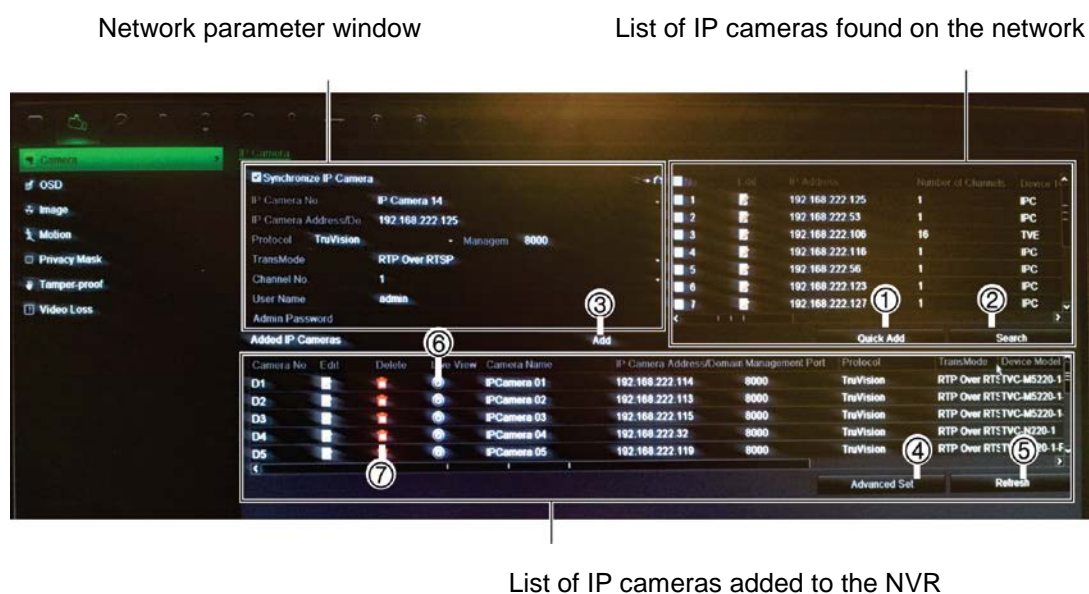

1. Quick Add: Add the selected cameras from the search results list to the NVR system without modifying the camera configuration.
2. Search: Search the network for available IP cameras.
3. Add: After entering the details of a camera in the configuration window, add it to NVR system.
4. Advanced Set: Modify the settings of a camera.
5. Refresh: Update the information displayed on a camera in the NVR device list.
6. Live view: View selected IP camera.
7. Delete: Delete selected IP camera.

There are two ways to add a camera to the NVR system:

- **Automatic:** Use this method if the IP cameras are located on the same LAN as the NVR.
- **Manual:** Use this method if the IP cameras are located on a different LAN from the NVR or are located on the internet. You can also synchronize the IP camera and NVR network parameters (see Figure 36).

Figure 36: Synchronize IP camera and NVR

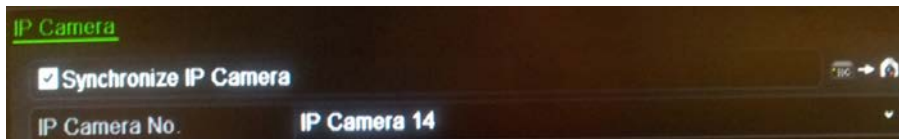

To automatically add an IP camera

1. Click the **Camera Management** settings icon in the menu toolbar and select **Camera**.
2. Click **Search** to locate any IP cameras located in the NVR LAN. When the search is complete, a list of the available cameras is shown.
3. Check the boxes of the desired cameras that you want to add to the NVR system.
4. Click **Quick Add** to add the selected cameras to the list of devices in the NVR system.

The cameras are added to the end of the list of devices.

5. To test if a camera connection is operational, select the desired camera from the list of devices connected to the NVR and click **Live**. A pop-up screen should appear showing the camera's live view.

To manually add an IP camera

1. Click the **Camera Management** settings icon in the menu toolbar and select **Camera**.
2. There are two ways to configure the IP camera:

Leave the **Synchronize IP Camera** check box unchecked. The IP camera's parameters are automatically retrieved by the NVR and displayed.

— Or —

Click the **Synchronize IP Camera** check box. The NVR parameters are pushed to the IP camera.

Note: If any of the values for the IP camera address, protocol, management port, user name, or camera admin password are incorrect, the NVR will not be able to communicate with the camera. If there is a connection problem, please check these values.

- Click **Add** to add the camera to the list of devices in the NVR system.

The camera is added to the end of the list of devices.

Note: Only one camera can be manually added at a time.

Configuring the camera OSD settings

The on-screen display (OSD) settings appear in live view mode and include the camera name, time and date. They also are included in recordings.

You can also adjust the transparency of the OSD relative to the background so that it is easier to read or is less prominent on screen.

To configure the OSD settings:

- Click the **Camera Management** settings icon in the menu toolbar and select **OSD**.



- Enter a name for the camera, if required.
- Check the Display Name, Display Date, and Display Week boxes to display the camera name, date, and week.
- Select a date format and a time format.
- Select how you want the camera information displayed.

Select one of the options from the drop-down list. Default is non-transparent/non-flashing.

- Transparent & flashing
 - Transparent & not flashing
 - Non-transparent & flashing
 - Non-transparent & non-flashing
- There are two red text boxes in the camera view screen; one for the camera name and the other for the date/time. Using the mouse, click and drag a text box to the desired position.
 - Click **Apply** to save the settings and then **Back** to return to live view.

Setting up privacy masking

You can define an area on screen to remain hidden from view. For example, you can choose to block the view of a camera when overlooking residential premises. This hidden area is referred to as privacy masking. Privacy masking cannot be viewed in live view or recorded mode, and appears as a blank area on the video image.

However, although you can select the privacy masking option for IP cameras, you cannot set up an area where it applies on-screen. Areas are selected from the IP camera itself. Refer to the IP camera user manual for information on doing this.

To setup a privacy mask:

1. Click the **Camera Management** icon in the menu toolbar and select **Privacy mask**.
2. Select the camera for which to set up privacy masking.
3. Check the **Enable Privacy Mask** box to enable the feature.
4. Set up the mask area. Up to four areas can be set.

Using the mouse, click and drag a privacy-mask box in the camera view screen over the desired area. You can set up to four areas for privacy masking. Masked areas are dimmed and outlined in four different colors. Click **Apply** to save settings.



To delete a mask, click **Clear** for that color mask.

5. Click **Apply** to save the settings and then click **Back** to return to live view.

Adjusting camera image settings

You may need to adjust the camera image depending on the location background in order to get the best image quality.

The system has four preset mode settings for frequently encountered lighting conditions; Standard, Indoor, Low light and Outdoor. However, you can also manually adjust the brightness, saturation, contrast, and hue values using the Customize option. Adjustments to the settings affect both live view and recorded images.

Note: These options can also be modified from the image settings button on the live view quick access toolbar (see “Accessing frequently used commands” on page 31.)

To adjust display settings:

1. Click the **Camera Management** icon in the menu toolbar and select **Image**.
2. Select the camera for which to adjust the video image settings.
3. Select the desired mode value. Changes are seen immediately on screen.

If “Customize” is selected, adjust the brightness, saturation, contrast, and hue values by dragging each scroll bar.

4. Click **Apply** to save the settings and then click **Back** to return to live view.

Chapter 15

NVR management

This chapter describes:

- Configuring the RS-232 port
- Updating system firmware
- Restoring default settings
- Viewing system information
- Viewing system logs

Configuring the RS-232 port

Use the **System Settings** menu to configure the RS-232 parameters such as baud rate, data bit, stop bit, parity, flow control, and usage.

There are three ways the RS-232 port can be used:

- **ProBridge:** POS and ATM text insertion supported via the ProBridge accessory connected to the RS-232 port. See “Capturing text insertions” on page 76 for more information.
- **ATS/Challenger:** NTP time sync supported to foreign device over the RS-232 port.
- **Technical support:** Console mode.

Updating system firmware

The firmware on the NVR can be updated using four methods:

- Via an USB device
- Over the network via an FTP server
- Via the NVR web browser
- Using TruVision Navigator. For further information, refer to the TruVision Navigator user manual.

The firmware upgrade file is labeled *tvn50.dav*.

To update the system firmware using a USB device:

1. Download on to a USB the latest firmware from our web site at:
<http://www.interlogix.com/library>
- Or -
www.utcssecurityproductspages.eu/videoupgrades
2. Connect the USB device to the NVR.
3. Click the **System Settings** icon in the menu toolbar.
4. Select **Upgrade > Local Upgrade**. The list of files on the USB is displayed.

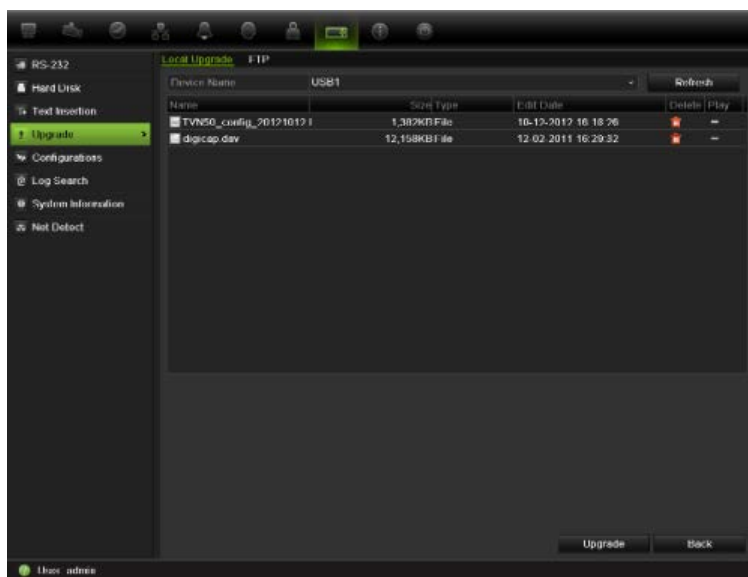

5. Select the file and click **Upgrade**. Click **Yes** to begin the upgrade process.
6. When the upgrade process is completed, reboot the NVR.

To update the system firmware via a FTP server:

For engineering purposes only.

Restoring default settings

To restore the default factory settings of the NVR:

1. Click the **System Settings** icon in the menu toolbar and select **Configuration**.
2. Click the **Default** tab. Click **OK** to confirm you want to restore default settings.

Note: Network information such as IP address, subnet mask, gateway, MTU, NIC working mode, server port and default route are not restored to factory default settings.

Viewing system information

To view system information:

1. Click the **System Settings** icon in the menu toolbar and select **System Information**.
2. To view device information, click the **Device Info** tab.
3. To view camera information, click the **camera** tab.

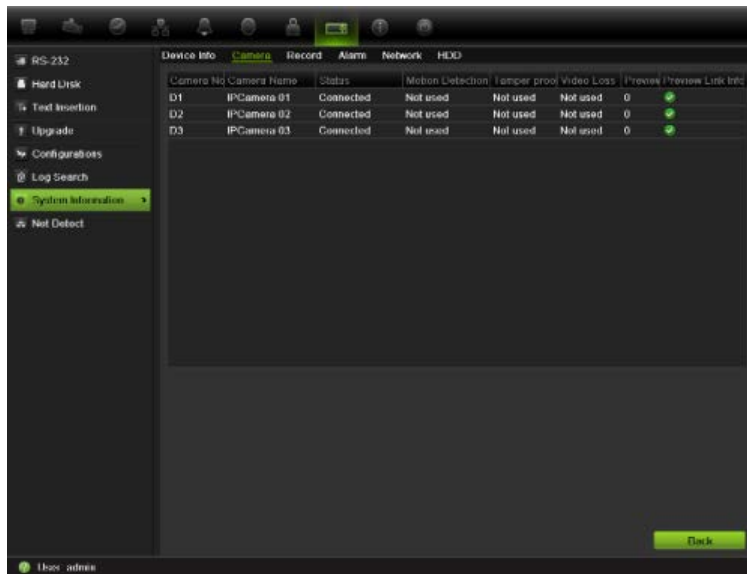

4. To view record information, click the **Record** tab.

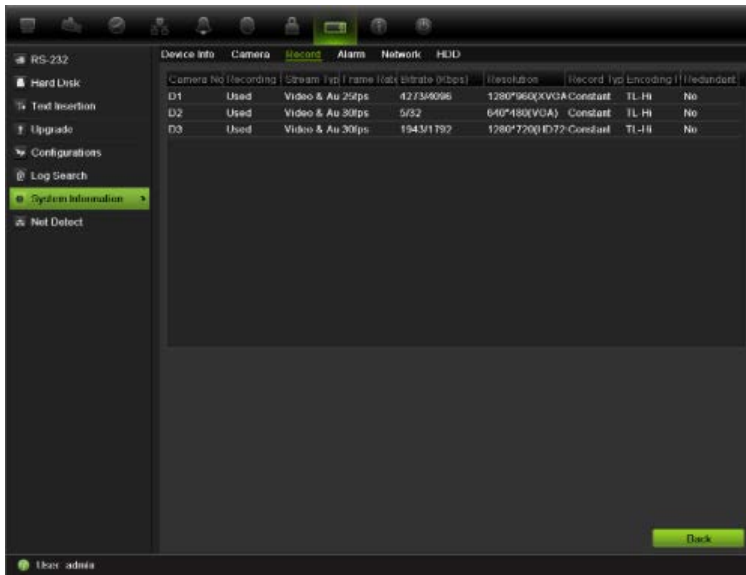

5. To view alarm information, click the **Alarm** tab.

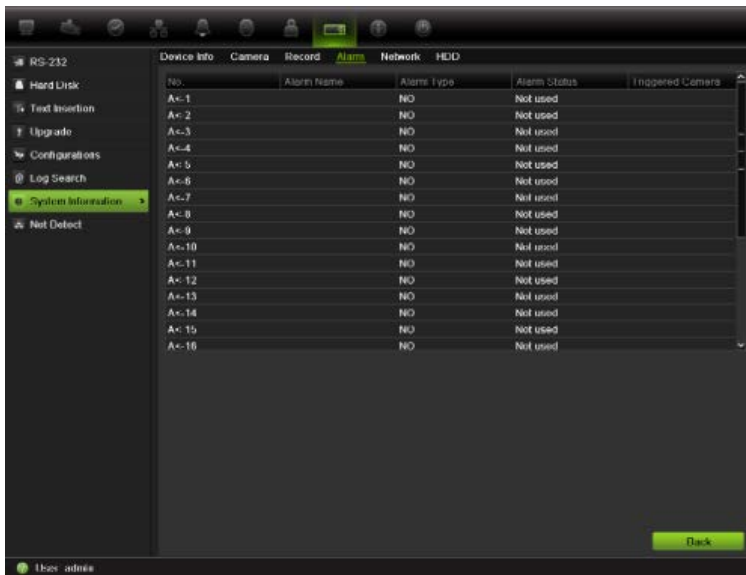

6. To view network information, click the **Network** tab.



7. To view HDD information, click the **HDD** tab.

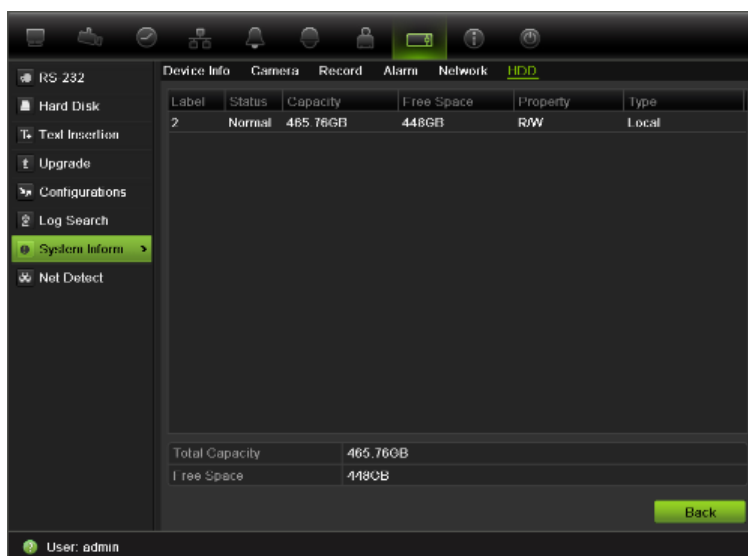

8. Click **Back** to return to live view.

Searching system logs for events

Many events of the NVR, such as operation, alarm and notification, are logged into the system logs. They can be viewed and exported at any time.

Up to 2000 log files can be viewed at once.

Log files can also be exported onto a USB device. The exported file is named according to the time it was exported. For example: *20120729124841logBack.txt*.

Note: Connect the backup device, such as a USB stick, to the NVR before commencing the log search.

To search and export log files:

1. Click the **System Settings** icon in the menu toolbar and select **Log search**.
2. Enter the search parameters and click **Search** to begin the search. The logs matching the search criteria are displayed.



3. To view more detail information about a particular log entry, select the entry and click or double-click the log entry.
5. If available, you can also view the associated video to the selected log entry by clicking its play button .
5. To export a log entry, select a log and click **Export**.
4. Click **Back** to return to live view.

Chapter 16

User management

By default the NVR comes with three user accounts: an Administrator account, an Operator account and a Guest account. These accounts provide multiple levels of access and functionality. See Table 18 below for a description of the different user accounts.

Table 18: User accounts

User	Description
Administrator	<p>The administrator account includes extended menu with full access to all settings. The Administrator has the authority to add, delete or configure parameters for many of the system functions.</p> <p>There can only be one administrator.</p> <p>The user name is admin. The name cannot be modified.</p> <p>The default password is 1234.</p>
Operator	<p>The operator account includes reduced menu access to Video settings (inaccessible features are not visible).</p> <p>The default user name is "operator".</p> <p>The default password is 4321.</p>
Guest	<p>The guest account includes menu access with no programming possibilities (inaccessible features are not visible).</p> <p>The default user name is "guest".</p> <p>The default password is Empty.</p>

Note: The default passwords should be changed for security reasons.

Adding a new user

Only a system administrator can create a user. You can add up to 31 new users. The access privileges of Operator and Guest users are predefined and cannot be modified

To add new users:

1. Click the **User Management** icon in the menu toolbar to display its screen.
2. Click **Add** to enter the Add User screen.
3. Enter the new user's name and password. Both the user name and password can have up to 16 alphanumeric characters.
4. Select the new user's access level: Operator or Guest.
5. Enter the user's MAC address to let the user access the NVR from a remote computer with this MAC address.
6. Click **Apply** to save the settings and **OK** to return to the previous screen.
7. Define the user's permissions.

Click the Permission button  for the new user. In the Permissions pop-up screen check the required access privileges for local, remote and camera configuration. See "Customizing a user's access privileges" below for the permission descriptions for each group.

Click **Apply** to save the settings and **OK** to return to the previous screen.

8. Click **Back** to return to live view.

Customizing a user's access privileges

Only an administrator can allocate access privileges to Operator and Guest users. The access privileges can be customized for each user's needs. The administrator's access privileges cannot be changed.

There are three types of privilege settings: Local Configuration, Remote Configuration, and Camera Configuration.

Note: Only the administrator can restore factory default settings.

Local configuration settings:

- **Local Log Search:** Search and view logs of the NVR.
- **Local Camera Management:** Locally adding, deleting, and editing of IP cameras.
- **Local Advanced Operation:** Access HDD management (including the initialization and modification of disk properties). Update system firmware as well as manually trigger and clear the I/O alarm output.
- **Local Shutdown/Reboot:** Shutdown or reboot the NVR.

Remote configuration settings:

- **Remote Log Search:** Remotely view logs that are saved on the NVR.
- **Remote Parameter Settings:** Delete and restore the factory defaults.
- **Remote Camera Management:** Remotely adding, deleting, and editing of IP cameras.
- **Remote Serial Port Control:** For future use.
- **Two-Way Audio:** Use two-way audio between the remote client and the NVR.
- **Remote Alarm Control:** Remotely trigger and clear the I/O alarm output. Alarm and notification settings must be configured properly to upload to host.
- **Remote Advanced Operation:** Remotely manage HDDs (initializing and setting properties for HDDs) as well as remotely update system firmware.
- **Remote Shutdown/Reboot:** Remotely shutdown or reboot the NVR.

Camera configuration settings:

By default, all IP cameras are enabled for operators for each of these settings and guests have Local Playback and Remote Playback privileges by default.

- **Remote Live View:** Select and view live video over the network.
- **Local Manual Operation:** Locally start/stop manual recording on any of the channels, snapshots, and video clips.
- **Local Playback:** Locally play recorded files that are on the NVR.
- **Remote Playback:** Remotely play and download recorded files that are on the NVR.
- **Local PTZ Control:** Locally controlling PTZ dome cameras.
- **Remote PTZ Control:** Remotely control PTZ dome cameras.
- **Local Video Export:** Locally back up recorded files from any of the channels.

To customize a user's access privileges:

1. Click the **User Management** icon in the menu toolbar to display its screen.
2. Click the Permission button  for the user whose access privileges need to be changed. The Permissions pop-up screen appears.
3. Click **Apply** to save the settings.
4. Click the **OK** button to return to the previous screen.
8. Click **Back** to return to live view.

Deleting a user

Only a system administrator can delete a user.

To delete a user from the NVR:

1. Click the **User Management** icon in the menu toolbar to display its screen.
2. Click the **Delete** button  for the user to be deleted.
3. Click **Yes** in the pop-up screen to confirm deletion. The user is immediately deleted.
4. Click **Back** to return to live view.

Modifying a user

A user's name, password, access level and MAC address can be changed. Only a system administrator can modify a user.

To modify a user:

1. Click the **User Management** icon in the menu toolbar to display its screen.
2. Click the **Edit** button  for the user whose access privileges need to be changed. The Edit User pop-up screen appears.
3. Edit the user information and click **Apply** to save the settings. .
4. Click the **OK** button to return to the previous screen.
5. Click **Back** to return to live view.

Changing the Admin password

The administrator's password can be changed in the **User Management** menu. Click the **Change Password** tab and enter the new information. The administrator's MAC address can be changed here too. Once completed, click **Apply** to save the settings.

Chapter 17

iTVRmobile

You can easily log on to the TVN 50 using the TruVision iTVRmobile application. Once installed on your iPhone, it can be used over a wireless network to remotely view live video from NVRs, IP cameras, PTZ cameras and DVSs. It can also be used to control PTZ cameras.

For detailed information on setting up and using the iTVRmobile application, please refer to the iTVRmobile user manual.

Setup and login

Download the **TruVision TVRmobile** application from the iTunes Store to your iPhone. The iTVRmobile appears on the iPhone home page:

Figure 37: iTVRmobile application icon



You need to register an administrator when using this application for the first time. Enter the user name and password in the register interface and click **Register** to complete user registration.

The next time the application is used, the user name of the last user is displayed by default. When logging in, you also can enable **Auto Login** so that the application will automatically login next time.

Once logged in, the iTVRmobile main menu appears. See Figure 38 below for further information.

Figure 38: Main menu description



Live	Live view mode and PTZ control.
Devices	Manage devices such as add a new device, delete a device, display information about the device.
Favorites	Define specific cameras as your favorites so that you can quickly jump to them.
Local Config	Configure the speed of PTZ control and auto login setup.
Account Setting	Password modification.
Help	Help information.
About	Software version.



Live view

Tap the iTVRmobile icon on the iPhone home page to open the application. Enter your user password, if requested. See Figure 39 for a description of the live view interface.

Figure 39: Live view and toolbar icons

The selected video tile is highlighted by a green frame



Button	Description
	Tap to return to the main menu. Note: This option is only available when in the iPhone is held in portrait orientation.
	This icon appears when there is no camera connected. Tap the cross to obtain the Select Channel screen and select a camera for live view from the list of devices.
	Tap to change the camera in the selected video tile. If there are already four video tiles open in multiview, the next camera selected will replace the camera that was first opened.



Stop: Tap to stop live streaming of video from the selected camera.



Bookmark: Tap to create bookmarks. Bookmarks are groups of cameras that can be accessed together.









Snapshot: Tap to take a snapshot of the live view images.



PTZ control: Tap to call up the PTZ control arrows on-screen for PTZ control.

To access live view:

1. In the main menu, tap **Live** to access live view. Live view is in 2X2 multiview mode by default. The selected video tile has a green frame.
2. Double-tap  or  to open the list of devices, bookmarks and favorites available and select the desired camera.
3. Tap the desired device, such as a NVR. All cameras listed under this device are shown.
4. Tap the desired camera in the list. The live view immediately appears on-screen. By default it occupies one of the four video tiles.
5. To display another camera in live view, double-tap  or  again and select the desired camera from the list. Repeat for the other two video tiles, if required.
6. To stop live view for a selected camera, select a camera. The selected camera has a green frame. Tap . A green cross appears in the video tile.
7. To return to the main menu, tap **iTVRmobile**.

Live view from the camera is not disconnected when accessing the main menu. You can, for example, change configuration settings and then return to live view by tapping  again. The application returns to the live view of the selected camera.

Controlling a PTZ camera

The application supports main and substream in live view. Substream is default. When selecting the main stream option in live view, please refer to the table below for the recommended parameter settings:

Table 19: Main stream recommended parameters

Resolution	Frame rate	Bit rate
XVGA	1 fps	320 Kbps
HD900	1 fps	320 Kbps
720P	1 fps	320 Kbps
UXGA	1 fps	320 Kbps
1080P	1 fps	320 Kbps
SVGA	4 fps	320 Kbps
VGA	4 fps	320 Kbps
4CIF	6 fps	512 Kbps
CIF	Max.	320 Kbps
DCIF	15 fps	512 Kbps
2CIF	Max.	512 Kbps
QCIF	Max.	320 Kbps



To control a PTZ camera:

1. In the main menu, tap **Live** to access live view.
2. Tap  to call up the PTZ toolbar and on-screen arrows.



3. Drag your finger across the on-screen arrows to carefully position the camera in the desired preset location.

 PTZ up
  PTZ down
  PTZ left
  PTZ right

4. To call up a preset position, tap  to bring up the Call/Set screen. Enter a preset number and tap **Call**. The camera moves to the preprogrammed position. Tap  again to exit the preset configuration screen.
5. To zoom in and out of the selected camera image, pinch the screen to zoom in or out. This option is only available for PTZ cameras.
6. To adjust the brightness of the camera image, tap the iris icon  to open the iris scrubber bar. Drag the playhead along the scrubber bar to adjust the image brightness.

Device management

The device list is empty by default. You must first add the required devices to the iTVRmobile device list before you can access them.

Note: Up to 16 devices can be added to the application.

To add a new device:

1. In the main menu, tap **Devices**. The Devices page appears. All devices already added to the app are listed.
2. Tap **Add**. The New Device page appears.
3. Enter the following information:
 - Device name:** Enter the name of the device to be linked, such as a TruVision NVR or TruVision IP cameras. The name can have up to 16 alphanumeric characters.
 - Register mode:** Select either IP or DDNS. Use DDNS when there is no fixed IP address available.
 - Address:** Enter the IP or dynamic name address of the device.
 - Port:** Enter the com port address of the device. For example, 8000 (default).
 - User name:** Enter the device's user name. It can have up to 16 alphanumeric characters.
 - Password:** Enter the device's password.
 - Chan. no.:** Enter the number of cameras to be linked.
4. Tap **Save** to save the settings. The device is added to the device list.
5. In the Device page, tap **Add** again to add another device to the application or tap **iTVRmobile** to exit and return to the main menu.

To modify or delete a device:

1. In the main menu, tap **Devices**. The Devices page appears. All devices already added to the app are listed.
2. To modify the parameters of a device: Tap  next to the selected device to be modified. The list of parameters that can be modified appears. Tap **Edit**. Tap the parameter to be modified and enter the new value using the keypad. Tap **Done** and then **Save** to save the changes or **Cancel** to abort and return to the Devices Detail screen.
3. To delete a device: Swipe your finger across the device to be deleted in the list. The Delete button appears. Tap **Delete**.
4. Tap **iTVRmobile** to exit and return to the main menu.

Favorites

Use the **Favorites** menu to manage frequently used cameras and bookmarks in live view.

Tap and navigate to 'Channels'->'MENU'->'ADD' to go to the Favorites interface. Tap the device to display the cameras list. Select any camera to add to your favorites list by selecting it.

To delete an item in Favorites, in the main menu tap and navigate to 'Bookmarks' or 'Channels'. The list of cameras or bookmarks appears. Tap the "Delete" button to delete it.

Local configuration

Use the **Local Config** menu to modify the speed of the pan and tilt movement of PTZ cameras as well as to enable/disable automatic login using the current user next time the applicatoin is used.

Change passwords

Use the **Account Setting** menu to modify your current password. Enter the old password, the new password and then confirm new password to complete the change.

Snapshots

Snapshots are automatically saved in the Photos application.

Appendix A

Specifications

TVN 5032	
Video & audio input	
Video compression	H.264
Audio compression	G729, G711, G726, G722, L16
Audio input	1-ch, BNC (2.0 Vp-p, 75 Ω)
Two-way audio	1-ch, RCA (2.0 Vp-p, 1 kΩ)
Video & audio output	
HDMI output	1-ch, Resolution: 1920 × 1080P / 60 Hz, 1920 × 1080P / 50 Hz, 1600 × 1200 / 60 Hz, 1280 × 1024 / 60 Hz, 1280 × 720 / 60 Hz, 1024 × 768 / 60 Hz
VGA output	1-ch, Resolution: 1920 × 1080P / 60 Hz, 1600 × 1200 / 60 Hz, 1280 × 1024 / 60 Hz, 1280 × 720 / 60 Hz, 1024 × 768 / 60 Hz
CVBS output	1-ch, BNC (1.0 Vp-p, 75 Ω), Resolution: PAL: 704 × 576; NTSC: 704 × 480
Video spot output	1-ch, BNC (1.0 Vp-p, 75 Ω), Resolution: PAL: 704 × 576; NTSC: 704 × 480
Playback resolution	5MP /3MP /1080P /UXGA /720P /VGA / 4CIF / 2CIF / CIF / QCIF
Frame rate	25 fps (PAL) / 30 fps (NTSC)
IP video input	32-ch, and Maximum Input bandwidth is 80Mbps
Audio output	2-ch, RCA (Linear, 600 Ω)
Audio bit rate	16 Kbps
Dual-stream	Support (Sub-stream at CIF/QCIF: 25 fps (PAL) / 30 fps (NTSC))
Stream type	Video, Video & Audio
Playback resolution	4CIF / 2CIF / CIF / QCIF
Synchronous playback	16-ch

TVN 5032	
Hard disk	
SATA	8 SATA interfaces
e-SATA	1 e-SATA interface
Capacity	Up to 2TB capacity for each disk
External interface	
Network interface	2 RJ45 10M / 100M / 1000M Ethernet interface
Serial interface	1 RS-232 interface (for ProBridge, Challenger, Technical Support); 1 RS-485 interface (for PTZ control); 1 RS-485 keyboard interface (for KTD405 keyboard control)
USB interface	3, USB 2.0
Alarm in	16
Alarm out	4
Miscellaneous	
Power supply	100 to 240 VAC, 6.3 A, 50 to 60 Hz
Power consumption (without HDD or DVD-R/W)	≤ 45 W
Operating temperature	-10 to +55 °C (14 to 131 °F)
Relative humidity	10 to 90%
Chassis	19-inch rack-mounted 2U chassis
Dimensions (W x H x D)	445 x 470 x 90 mm (17.5 x 18.5 x 3.54 in.)
Weight	≤ 8 kg (17.6 lb.) (without HDD or DVD-R/W)

Appendix B

PTZ protocols

Interlogix-485	PHILIPS
Interlogix-422	PHILIPS-3
Kalatel	SAE
DSCP	Samsung
HIKVISION	Siemens
Honeywell	SONY-EVI-D30/31
INFINOVA	SONY-EVI-D70
KTD-348	SONY-EVI-D100/P
LG MULTIX	TECHWIN
LILIN	VICON
PANASONIC_CS850	YOULI
PELCO-D	
PELCO-P	

Appendix C

Port forwarding information

A router is a device that lets you share your internet connection between multiple computers. Most routers will not allow incoming traffic to the device unless you have configured them to forward the necessary ports to that device. By default our software and devices (DVRs and NVRs) require the following ports to be forwarded:

Note: Port forwarding may reduce the security of the computers on your network. Please contact your network administrator or a qualified network technician for further information.

Table 20: Description of the ports

Port	Port name	Description
80	HTTP protocol	Used to connect via IE browser.
8000	Client Software Port	Used to connect to video streams.
554	RTSP Port	Real time streaming protocol. Used to record video remotely.
1024	RTSP Port for 3G/4G	Use with mobile apps. Used for 3G/4G connection.

Note: It is recommended that the RTSP port 1024 should only be used when experiencing connection issues over a 3G/4G connection.

For example: If the client port is changed to 9000 then the +200 port will be 9200. Using the default client port 8000 then the +200 port will be 8200.

Seeking further assistance

Third-party assistance on configuring popular routers can be found at:

<http://www.portforward.com/>

<http://canyouseeme.org/>

<http://yougetsignal.com>

Note: These links are not affiliated with nor supported by Interlogix technical support.

Many router manufacturers also offer guides on their websites as well as including documentation with the product.

On most routers the brand and model number is located on or near the serial number sticker on the bottom of the device.

If you cannot find any information for your particular router, please contact your router manufacturer or internet service provider for further assistance.

Appendix D

KTD-405 keypad

Supported firmware

TVN 50XX-YYY firmware	1.i or higher
KTD-405U (-2DU) keypad firmware:	1.4.00

Note: XX represents the number of video channels

YYY represents the NVR storage configuration such as 1T = 1 TB, etc.

Wiring the keypad

Connect the RS-485 bus of the KTD-405 I/O box to the TVN 50 Keyb A/B terminal port.

Table 21: Keypad and NVR connections

KTD-405 I/O box	TVN 50 connection
RS-485 A	Keyb A
RS-485 B	Keyb B

Figure 40: Keypad and NVR connections

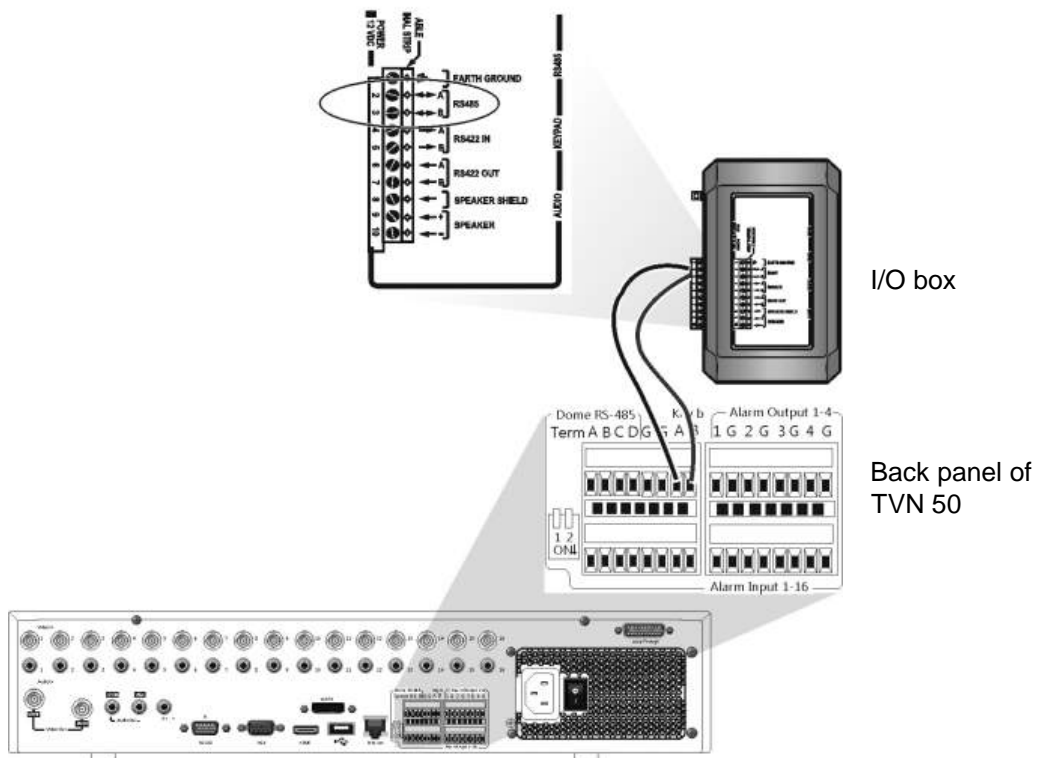

Setting up the keypad to work with the TVN 50

The keypad must be in zone mode to connect correctly with the TVN 50.

Further information on connecting and programming the KTD-405 keypad can be found in the user manual.

To set the keypad in zone mode:

1. Log into the keypad using the Admin password. Hold down the Enter button (↵) until a beep sounds and then enter the following code: **1 4 7 6**. Push the **seq** button to confirm.
2. Scroll through the menus with the **▶** button until this menu appears:

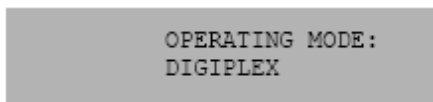

3. Change *Operating Mode* to *Zone* by moving the joystick down.
4. Quit the menu by pressing the **seq** button. The display will show, for example:

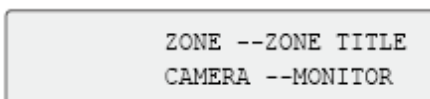

5. To connect it to the NVR, press the **zone** button and enter the ID number of the TVN 50. The default value is “1”.
6. To configure the NVR zone ID number, at the NVR enter the Monitor screen by selecting **Display Mode Settings** in the main menu and select **Monitor**. Under Zone ID, enter the zone ID value. The default value is “1”.

Note: The zone ID value must be identical for the NVR and keypad.

The TVN 50 is now connected to the KTD-405 keypad.

TVN 50 and keypad functions

The KTD-405U acts as a NVR control keypad when connected to the TVN 50. The keypad mimics many of the functions available from the front panel of the TVN 50.

Unavailable TVN 50 functions

The following TVN 50 functions are unavailable when using the keypad to control the TVN 50:

- Export video
- Shadow tour
- Select motion detection or tampering zones
- Archive records
- Capture video

If these functions are required, it is recommended to use a mouse in conjunction with the keypad as all TVN 50 functions will then be available.

Unavailable keypad functions

The following keypad buttons are unavailable when using the keypad to control the TVN 50:

Figure 41: Unavailable keypad buttons

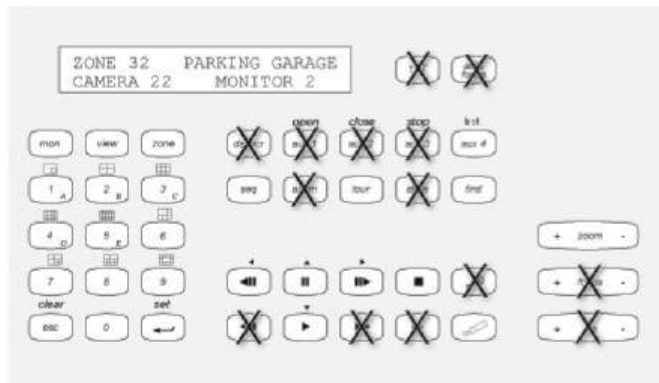

DSC/VCR	Autofocus	● (Record mode)
Aux 1	Alarm	Store
Aux 2	Iris +/-	▶▶ Fast forward
Aux 3	Focus +/-	◀◀ Fast backward
Aux 4	(Magnification)	
Ist		

Operating the keypad

You can navigate the NVR menus using the keypad buttons and joystick. However, not all maneuvers are available using the joystick.





See Table 22 on page 147 for the description of the NVR keypad mapping when using the KTD-405 keypad series. See Figure 41 above for a list of the keypad functions that are unavailable when connected to the NVR.

Example 1: To enter your password in the login screen using the keypad

1. In live view mode, press **esc** to activate the Login screen.
2. Press and hold **esc** and then press the arrow buttons (down, up, left, right) to move the cursor to the Password edit box. Once in the password box, release **esc**.
3. Press **Enter** () to activate the soft keyboard.
4. Press and hold **esc** and then press the arrow buttons to reach the first digit of the password. Release **esc** and press **Enter** () to select the digit.
Or move the joystick to the first digit of the password and press Enter ()
5. Repeat steps 2 to 4 for each digit of the password.
6. Move the cursor to the Enter button on the soft keyboard and press Enter () on the KTD-405 keypad to quit the soft keyboard.
7. Press and hold **esc** and then press the arrow buttons to navigate the cursor to activate OK button on the Login screen.

8. Press . The main menu appears.









Example 2: To modify a menu option using the keypad

1. In the main menu press and hold **esc** and then press the arrow buttons to navigate to the desired menu icon (for example, Display Mode Settings).
2. Press **esc** and  to go to setup menu.
3. Press **Zoom +** or **Zoom -** to scroll to the menu tab, **More Settings**.
4. When in the desired menu screen, press and hold **esc** and then press the arrow buttons to navigate the cursor to the option, **Menu Timeout**.
5. Press  to activate the dropdown menu.
6. Press and hold **esc** and then press the up/down arrow buttons to navigate to the desired option.
7. Press  to select the option.
8. Press and hold **esc** and then press the up/down arrow buttons to navigate to **Apply**. Press  to select it. Then navigate to **Back** to return to live view.

Instead of the arrow buttons, you can also use the joystick on the keyboard.

TVN 50 mapping to the KTD-405 keypad

Table 22: TVN 50 mapping to the KTD-405 keypad

Task	Keypad action	Further information
• Menu mode		
Call up or exit menu	In live view, press esc .	To exit the menu: go to the Power Manager menu and select Logout.
Move through the menus	Press and hold esc and then press the arrow buttons or use the joystick.	 Down ,  Up ,  Left ,  Right
Move between menu tabs	Press Zoom + or Zoom - to switch between menu tabs.	
Navigate to a menu option	Press and hold esc and then press the arrow buttons.	 Down ,  Up ,  Left ,  Right
Select a character or menu option	Press Enter ().	Note. If you press esc before pressing Enter , you quit the menu without saving any changes. It is the same as cancel.
Select the zone ID	Press zone to connect the keypad to the NVR and enter the Zone ID.	

Task	Keypad action	Further information
• Live view mode		
Call up a single camera	Press 0 to 9 and then press Enter (↵).	Using the numeric buttons 0 to 9 , enter the number of the camera and then press Enter (↵).
Call up multiview screens	Press view and then press button 5 to scroll through the next available multiview screen.	
Sequence through cameras	Press the seq button to scroll through the cameras in full screen.	
Switch to next/previous camera	Move the joystick to the right (= next camera), or the left (= previous camera)	
Switch between monitor A and monitor B	Press the mon button and button 1 to switch to monitor A. Press the mon button and button 2 to switch to monitor B.	
Manually acknowledge an alarm	Press Alarm .	
• PTZ functions		
Enter PTZ mode	In live view mode, press Enter (↵).	It is possible that you first need to login before you can access the PTZ mode.
PTZ functions (Up, Down, Left, Right, Zoom in, Zoom out)	Move the joystick to move the dome up, down, left and right Press zoom+ and zoom- .	KTD-405U : Turn the knob on the joystick to zoom in/zoom out. KTD-405-2DU : Press the zoom+ and zoom- buttons.
Call-up presets	Press Find + preset number.	Store presets via the configuration menu on the webpage of the IP dome
Call-up a preset tour	Press Tour + tour number	Store preset tours via the configuration menu on the webpage of the IP dome
Leave PTZ mode	Press esc .	
• Playback functions		
Search for recorded video	Press  .	Once password is entered, the Advanced Search menu appears.
All-day playback	Press  when in full screen.	All-day playback of the currently selected camera.
Stop playback	Press  to stop playback and return to live view mode.	

Task	Keypad action	Further information
Pause playback	Press to pause playback. Press ▶ to restart.	
Select one of the files in the search result screen	Press enter (↵) and move with the joystick to the desired file. Press ▶ to start playback.	
Change playback speed	Press and hold esc and then press the left/right arrow buttons or move the joystick to the left/right.	
Jump 30 seconds forwards or backwards during playback	Press and hold esc and then press the up/down arrow buttons or move the joystick up/down.	

Controlling a camera

When setting up and controlling your cameras in zone mode, refer to Table 23 below for the list of default PTZ addresses associated with a zone ID. This value is automatically populated in the system. You can modify the PTZ address in the PTZ menu to meet customer requirement.

Table 23: Default PTZ camera addresses by zone ID

Camera input	Zone ID of TVN 50															
	1	2	3	4	5	6	7	8	9	10	11	12	13	14	15	16
1	0	32	64	96	128	160	192	224	256	288	320	352	384	416	448	480
2	1	33	65	97	129	161	193	225	257	289	321	353	385	417	449	481
3	2	34	66	98	130	162	194	226	258	290	322	354	386	418	450	482
4	3	35	67	99	131	163	195	227	259	291	323	355	387	419	451	483
5	4	36	68	100	132	164	196	228	260	292	324	356	388	420	452	484
6	5	37	69	101	133	165	197	229	261	293	325	357	389	421	453	485
7	6	38	70	102	134	166	198	230	262	294	326	358	390	422	454	486
8	7	39	71	103	135	167	199	231	263	295	327	359	391	423	455	487
9	8	40	72	104	136	168	200	232	264	296	328	360	392	424	456	488
10	9	41	73	105	137	169	201	233	265	297	329	361	393	425	457	489
11	10	42	74	106	138	170	202	234	266	298	330	362	394	426	458	490
12	11	43	75	107	139	171	203	235	267	299	331	363	395	427	459	491
13	12	44	76	108	140	172	204	236	268	300	332	364	396	428	460	492
14	13	45	77	109	141	173	205	237	269	301	333	365	397	429	461	493
15	14	46	78	110	142	174	206	238	270	302	334	366	398	430	462	494
16	15	447	79	111	143	175	207	239	271	303	335	367	399	431	463	495

: KTD-405 keypad

Camera input	Zone ID of TVN 50															
	1	2	3	4	5	6	7	8	9	10	11	12	13	14	15	16
17	16	48	80	112	144	176	208	240	272	304	336	368	400	432	464	496
18	17	49	81	113	145	177	209	241	273	305	337	369	401	433	465	497
19	18	50	82	114	146	178	210	242	274	306	338	370	402	434	466	498
20	19	51	83	115	147	179	211	243	275	307	339	371	403	435	467	499
21	20	52	84	116	148	180	212	244	276	308	340	372	404	436	468	500
22	21	53	85	117	149	181	213	245	277	309	341	373	405	437	469	501
23	22	54	86	118	150	182	214	246	278	310	342	374	406	438	470	502
24	23	55	87	119	151	183	215	247	279	311	343	375	407	439	471	503
25	24	56	88	120	152	184	216	248	280	312	344	376	408	440	472	504
26	25	57	89	121	153	185	217	249	281	313	345	377	409	441	473	505
27	26	58	90	122	154	186	218	250	282	314	346	378	410	442	474	506
28	27	59	91	123	155	187	219	251	283	315	347	379	411	443	475	507
29	28	60	92	124	156	188	220	252	284	316	348	380	412	444	476	508
30	29	61	93	125	157	189	221	253	285	317	349	381	413	445	477	509
31	30	62	94	126	158	190	222	254	286	318	350	382	414	446	478	510
32	31	63	95	127	159	191	223	255	287	319	351	383	415	447	479	511

Appendix E

Maximum pre-recording times

The maximum pre-recording time that can be selected depends on the bit rate. Frame rate, resolution and image quality do not impact time.

Note: This information only applies when the bit rate is set to Constant (see “Initializing recording settings” on page 81 for more information).

Constant bit rate	Maximum pre-recording time (seconds)
32	30
48	30
64	30
80	30
96	30
128	30
160	30
192	30
224	30
256	30
320	30
384	30
448	30
512	30
640	30
768	30
896	30
1024	30
1280	25
1536	20

Constant bit rate	Maximum pre-recording time (seconds)
1792	15
2048	15
3072	10
4096	5

Appendix F

Supported PTZ commands

Table 24: Supported PTZ commands by camera protocols (Part 1)

Protocol	PTZ command												
	Tilt up	Tilt down	Pan left	Pan right	Left up	Left down	Right up	Right down	Auto pan	Zoom +	Zoom -	Focus +	Focus -
Interlogix-485	Y	Y	Y	Y	N	N	N	N	N	Y	Y	Y	Y
Interlogix-422	Y	Y	Y	Y	N	N	N	N	N	Y	Y	Y	Y
KALATEL	Y	Y	Y	Y	N	N	N	N	N	Y	Y	Y	Y
DSCP	Y	Y	Y	Y	N	N	N	N	N	Y	Y	Y	Y
HIKVISION	Y	Y	Y	Y	Y	Y	Y	Y	Y	Y	Y	Y	Y
Honeywell	Y	Y	Y	Y	N	N	N	N	N	Y	Y	Y	Y
INFINOVA	Y	Y	Y	Y	N	N	N	N	N	Y	Y	Y	Y
KTD-348	Y	Y	Y	Y	N	N	N	N	N	Y	Y	Y	Y
LG MULTIX	Y	Y	Y	Y	N	N	N	N	N	Y	Y	Y	Y
LILIN	Y	Y	Y	Y	N	N	N	N	N	Y	Y	Y	Y
PANASONIC_CS850	Y	Y	Y	Y	N	N	N	N	N	Y	Y	Y	Y
PELCO-D	Y	Y	Y	Y	Y*	Y*	Y*	Y*	Y	Y	Y	Y	Y
PELCO-P	Y	Y	Y	Y	Y*	Y*	Y*	Y*	Y	Y	Y	Y	Y
PHILIPS	Y	Y	Y	Y	N	N	N	N	N	Y	Y	Y	Y
PHILIPS-3	Y	Y	Y	Y	N	N	N	N	N	Y	Y	Y	Y
SAE	Y	Y	Y	Y	N	N	N	N	N	Y	Y	Y	Y
Samsung	Y	Y	Y	Y	N	N	N	N	N	Y	Y	Y	Y
Siemens	Y	Y	Y	Y	N	N	N	N	N	Y	Y	Y	Y
SONY-EVI-D30/31	Y	Y	Y	Y	N	N	N	N	N	N	N	N	N
SONY-EVI-D70	Y	Y	Y	Y	N	N	N	N	N	N	N	N	N
SONY-EVI-D100/P	Y	Y	Y	Y	N	N	N	N	N	N	N	N	N
TECHWIN	Y	Y	Y	Y	N	N	N	N	N	N	N	N	N
VICON	Y	Y	Y	Y	N	N	N	N	N	Y	Y	Y	Y

Protocol	PTZ command												
	Tilt up	Tilt down	Pan left	Pan right	Left up	Left down	Right up	Right down	Auto pan	Zoom +	Zoom -	Focus +	Focus -
YOULI	Y	Y	Y	Y	N	N	N	N	N	Y	Y	Y	Y

*: Hikvision only.

Table 25: Supported PTZ commands by camera protocols (Part 2)

Protocol	PTZ command										
	Iris+	Iris-	Light	Wiper	Zoom area	Center	Menu	Preset	Tour	Shadow tour	
Interlogix-485	Y	Y	N	N	N	N	N	Y	N	Y	
Interlogix-422	Y	Y	N	N	N	N	N	Y	N	Y	
KALATEL	Y	Y	N	N	N	N	N	Y	N	Y	
DSCP	Y	Y	N	N	N	N	N	Y	N	Y	
HIKVISION	Y	Y	N	N	Y	Y	Y	Y	Y	Y	
Honeywell	Y	Y	N	N	N	N	N	N	N	N	
INFINOVA	Y	Y	N	N	N	N	N	Y	N	Y	
KTD-348	Y	Y	N	N	N	N	N	Y	N	Y	
LG MULTIX	Y	Y	N	N	N	N	N	Y	Y	Y	
LILIN	Y	Y	N	N	N	N	N	N	N	N	
PANASONIC_CS850	Y	Y	N	N	N	N	N	Y	N	Y	
PELCO-D	Y	Y	Y**	Y#	N	N	N	Y	Y	Y	
PELCO-P	Y	Y	N	N	N	N	N	Y	Y	Y	
PHILIPS	Y	Y	N	N	N	N	N	N	N	N	
PHILPS-3	Y	Y	N	N	N	N	N	N	N	N	
SAE	Y	Y	N	N	N	N	N	Y	Y	Y	
Samsung	Y	Y	N	N	N	N	N	Y	N	Y	
Siemens	Y	Y	N	N	N	N	N	Y	N	Y	
SONY-EVI-D30/31	N	N	N	N	N	N	N	N	N	N	
SONY-EVI-D70	N	N	N	N	N	N	N	N	N	N	
SONY-EVI-D100/P	N	N	N	N	N	N	N	N	N	N	
TECHWIN	Y	Y	N	N	N	N	N	Y	N	N	
VICON	Y	Y	N	N	N	N	N	N	N	N	
YOULI	Y	Y	N	N	N	N	N	Y	N	N	

** : Aux. 2

: Aux. 1

Appendix G

Default menu settings

Display mode setting	
Monitor	
General	
	Language: English
	Device name: TVN 50
	Device address: 255
	Zone ID: 1
	VGA resolution: 1280*1024/60HZ
	HDMI resolution : 1280*720/60HZ(720P)
	Password required : Yes
	Scale output video: Yes
	Enable wizard: Yes
More setting	
	Monitor standard: NTSC/PAL. Auto detect at booting.
	Output mode: Standard
	Monitor brightness: 5
	Event hint: Yes
	Time bar transparent: Yes
	Enable Time Bar: Enabled
	Menu timeout: 5 min
	Mouse pointer speed: Lower
Layout	
General	
	Video output interface: VGA
	Live view mode: 4*4
	Dwell time: No swith
	Enable audio output: No
	Event output: HDMI

	Full screen monitoring dwell time: 10 s
View	Video output interface: VGA
	16 chan: 4*4 -A1 to A16
	8 chan: 3*3 - A1 to A8+1black screen
	4 chan: 2*2 - A1 to A4 (Different with PRD-5.1-138)
Time	
	Time setting
	Time Zone: GMT -8
	Time Format: 24-hour
	Display week: No
	Date Format: MM-DD-YYYY
	System date: Current system date
	System time: Current system time
	Auto DST Adjustment: No
	Enable DST: No
	From: Apr 1st Sun 2:00
	To: Oct last Sun 2:00
	DST bias: 60 min
Holiday	
	Holiday setting
	Status: All disable; Start date: 1st. Jan; End date: 1st Jan
Camera Management	
Camera	
	IP Camera
	Synchronize IP camera: No
	IP camera no.: IP camera 1
	IP camera address/domain: (Null)
	Protocol: TruVision
	Management port: 8000
	TransMode: RTP over RTSP
	Channel no.: 1
	User name: admin
	Admin password: (Null)

OSD	
	OSD setting
	Camera: Camera All
	Camera name: IPCamera 01
	Display name: Yes
	Display date: Yes
	Display week: Yes
	Date format: MM-DD-YYYY
	Time format: 24-hour or 12-hour AM/PM
	Display mode: Not transparent & not flashing
Image	
	Image setting
	Camera: Camera All
	Mode: Customize
Motion	
	Motion detection setting
	Camera: All
	Enable motion detection: No
	Rule: Trigger channel [camera-self]; Alarm schedule: All day for whole week; Rule: (Null)
	Sensitivity: Sensitivity 1
	Zone: (Null)
Privacy mask	
	Privacy mask setting
	Camera: All
	Enable privacy mask: No
	Zone: (Null)
Tamper proof	
	Tamper-proof setting
	Camera: All
	Enable tamper proof: No
	Rule: Alarm schedule all day for whole week; Rule: (Null)
	Sensitivity: Low
	Zone: (Null)
Video loss	
	Video loss setting
	Camera: All
	Enable video loss Alarm: No

		Rule: Alarm schedule all day for whole week; Rule: (Null)
Video Schedule		
Schedule		
Record		
		Camera: All
		Enable Schedule: Enable
		Schedule: All day for whole week TL-Hi
Encoding		
Record		
		Camera: All
		Encoding parameters: ->
		Stream type ->
		Resolution ->
		Bitrate type ->
		Video quality ->
		Frame rate ->
		Max. Bit rate mode ->
		Max. Bit rate ->
		Pre-record: 5 s
		Post-record: 5 s
		Auto delete: 0
		Record audio: Yes
Capture		
		Camera: All
		Resolution: 4 CIF
		Picture quality: Medium
More settings		
More settings		
		Event priority: Text In < Motion
		Overwrite: Yes
		eSATE: Record/Capture
Networking setting		
General		
General		
		Working Mode: Net Fault Tolerance
		Select NIC: bond0
		NIC Type: 10M/100M/1000M self-adaptive

		Enable DHCP: Yes
		IPv4 address: 192.168.1.82
		IPv4 subnet mask: 255.255.255.0
		IPv4 default gateway: 192.168.1.1
		IPv6 address1: fe80::240:3dff:fe7e:926f/64
		IPv6 address2: (Null)
		IPv6 address gateday: (Null)
		Mac address: (It depends)
		MTU: 1500
		Preferred DNS server: (Null)
		Alternate DNS server: (Null)
		Main NIC: LAN1
PPPoE		
	PPPoE	
		Enable PPPoE: No
		User name: (Null)
		Password: (Null)
		Confirm: (Null)
DDNS		
	DDNS	
		DDNS: Enable DDNS
		DDNS type: ezDDNS
		Server address: www.tvr-ddns.net
		Host Name: (Null)
		NAT: Disable
		Nat server port: 8000->0
		Nat HTTP port: 80->0
		NAT RTSP Service Port: 554
NTP		
	NTP	
		Enable NTP: No
		Interval:60min
		NTP server: time.nist.gov
		NTP Port:123
Email		
	Email	
		Enable server authentication: No
		User name: (Null)
		Password: (Null)

		SMTP server: (Null)
		SMTP port: 25
		Enable SSL: No
		Sender: (Null)
		Sender's address: (Null)
		Select receivers: Receiver 1
		Receiver: (Null)
		Receiver's address: (Null)
		Enable attached picture: No
		Interval: 2 s
SNMP		
	SNMP	
		Enable SNMP: No
		SNMP version: V2
		SNMP port: 161
		Read community: Public
		Write Community: Private
		Trap address: (Null)
		Trap port: 162
FTP	FTP	
		(Null)
More settings		
	More settings	
		Alarm host IP: (Null)
		Alarm host port: 0
		Server port: 8000
		HTTP port: 80
		Multicast IP: (Null)
		RTSP server port: 554

Alarm setting	
Alarm list	
	Alarm Inputs
	(A<-1 to A<-16)
	Alarm Outputs
	(A->1 to A->4)
Alarm Input	
	Alarm Input
	Alarm input no.: All
	Alarm name: (Null)
	Type: No
	Enable alarm input setting: No
	Rule: Trigger channel: No; Arming schedule: All day for whole week; Rule (Null); PTZ link: (Null)
Alarm Output	
	Alarm Output
	Alarm output no.: All
	Alarm name: (Null)
	Time out: 5 s
	Rule: All day for whole week
	Manual Alarm
	Trigger none
Notification	
	Notification
	HDD full: (Null)
	HDD error: Audio warning
	Network disconnected: (Null)
	IP conflicted: (Null)
	Illegal login: (Null)
	Abnormal record: Audio
PTZ setting	
General	
	General
	Camera: All
	Baud rate: 9600
	Date bit: 8
	Stop bit: 1
	Parity: None

		Flow ctrl: None
		PTZ protocol: Interlogix 485
		Address: 0 to 15 for camera 1 to 16
	More settings	
		(Null)
User setting		
	User	
		User management
		admin:1234
		operate: 4321
		guest: (Null)
		Change password
		(Null)
System setting		
	RS-232	
		RS-232 setting
		Baud rate: 115200
		Date bit: 8
		Stop bit: 1
		Parity: None
		Flow ctrl: None
		Usage: ProBridge
	Hard disk	
		(Null)
	Text Insertion	
		Text insertion
		Enable text insertion: No
		Access device: ATM
		Access mode: Probridge
		Start string: (Null)
	Upgrade	(Null)
	Configuration	(Null)
	Log search	
		Log search
		Current whole day, all types

System information	
	Device name: TVN 51
	Model: (model number)
	Serial no.: (Model's serial number)
	Firmware version:
	Encoding version:
	Panel version:
Net detect	
	Traffic:
	Network detection:
	Network delay, packet loss test
	Select NIC: bond0
	Destination address: (Null)
	Network packet export
	Device name: (Null)

Glossary

Term	Definition
Data redundancy	Writing data to two or more locations for backup and data recovery. For example, data can be stored on two or more HDDs.
DDNS	Dynamic DNS is a method, protocol, or network service that provides the capability for a networked device, such as a router or computer system using the Internet Protocol Suite, to notify a domain name server to change, in real time (ad-hoc) the active DNS configuration of its configured hostnames, addresses or other information stored in DNS
DHCP	Dynamic Host Configuration Protocol (DHCP) is a network application protocol used by devices (DHCP clients) to obtain configuration information for operation in an Internet Protocol network
Dual stream	Dual stream is a technology used to record high resolution video locally while transmitting a lower resolution stream over the network. The two streams are generated by the NVR, with the main stream having a maximum resolution of 4CIF and the substream having a maximum resolution of CIF.
DVR	Acronym for Digital Video Recorder. A DVR is device that is able to accept video signals from analog cameras, compress the signal and store it on its hard drives
HDD	Acronym for Hard Disk Drive. A storage medium which stores digitally encoded data on platters with magnetic surfaces
HTTP	Acronym for Hypertext Transfer Protocol. A protocol to transfer hypertext request and information between servers and browsers over a network
Hybrid DVR	A hybrid DVR is a combination of a DVR and NVR.
NTP	Acronym for Network Time Protocol. A protocol designed to synchronize the clocks of computers over a network.
NTSC	Acronym for National Television System Committee. NTSC is an analog television standard used in such countries as the United States and Japan. Each frame of an NTSC signal contains 525 scan lines at 60Hz
NVR	Acronym for Network Video Recorder. An NVR can be a PC-based or embedded system used for centralized management and storage for IP cameras, IP Domes and other DVRs.
PAL	Acronym for Phase Alternating Line. PAL is also another video standard used in broadcast televisions systems in large parts of the world. PAL signal contains 625 scan lines at 50Hz.

Term	Definition
PPPoE	Point-to-Point Protocol over Ethernet is a network protocol for encapsulating Point-to-Point Protocol (PPP) frames inside Ethernet frames. It is used mainly with ADSL services where individual users connect to the ADSL transceiver (modem) over Ethernet and in plain Metro Ethernet network.
PTZ	Acronym for Pan, Tilt, Zoom. PTZ dome cameras are motor driven systems that allow the camera to pan left and right, tilt up and down and zoom in and out
USB	Acronym for Universal Serial Bus. USB is a plug-and-play serial bus standard to interface devices to a host computer.

Index

A

- Active X, 67
- Alarm notifications
 - external alarms, 94
 - types, 91
 - video loss, 97
 - video tampering, 98
- Alarm outputs
 - manually acknowledging, 96
- Archiving
 - exporting files to a backup device, 62
 - quick archive, 61
 - snapshots, 64
 - video clips, 64
- Audio
 - connecting audio inputs and outputs, 8

B

- Back panel description, 4
- Backup devices
 - managing, 65
- Bookmarks
 - playback, 57
 - saving, 57
 - types, 57
- Brightness, contrast and saturation
 - modifying, 119

C

- Camera
 - adding/deleting, 115
- Cameras
 - privacy masking, 118
 - setting up sequencing, 35

D

- Daily schedules
 - recording, 85
- Date
 - configuring display, 38
- DDNS settings, 101
- Default menu settings, 155
- Default settings

- restore, 123

- Digital zoom
 - description, 32
 - quick access, 51
- Digital zoom in playback, 60
- DST
 - set up, 38

E

- E-mail notifications
 - set up, 103
- eSATA, 112
- Event logs
 - searching remotely, 75
- Export files, 65
- External alarm
 - setting up to record when triggered, 94
- External alarm schedules
 - recording, 87

F

- Factory default settings
 - restore, 123
- Firmware
 - updating, 122
- Frame-by-frame playback, 60
- Front panel description, 18
- Full screen viewing, 30

H

- HDD
 - checking status, 111
 - grouping, 110
 - initializing, 109
 - properties, 111
 - redundancy, 89
 - set to read only, 89
 - setting up HDD alarms, 112
- Holiday schedules
 - recording, 86
- HTTP port settings, 105

I

- Instant playback, 52

IP devices supported, 138

iTVRmobile

- device management, 135
- favorites, 136
- live view, 132
- login, 131
- PTZ camera control, 133

K

Keypad

- connecting to RS-485 port, 8
- wiring to the NVR, 5

KTD-405 keypad

- accessing NVR functions, 146
- controlling a camera, 149
- firmware supported, 143
- set up in zone mode, 144
- set up TVR 41 device address, 144
- wiring, 143

L

Language

- change GUI language, 36

Live view mode

- digital zoom, 32
- full screen view, 30
- multiview, 30
- sequencing cameras, 31
- switch monitors, 27
- time and date display, 38

Lock/unlock recorded files, 87

Login password, 36

Logs

- view system log, 125

M

Main menu

- accessing, 23
- description, 23
- icon descriptions, 23

Menu timeout

- change time, 36

Monitors

- change output mode, 36
- connecting, 8
- priority, 27
- switch monitors, 27

Motion detection, 92

- defining motion detection area, 92
- setting the sensitivity level, 92
- setting the target size, 92

Motion search toolbar

- quick access, 51

Mouse pointer speed

- change, 36

Mouse pop-up menu, 28

Multicast settings, 104

Multiview, 30

N

NAS, 78

Network packet data

- exporting, 106

Network settings

- general set up, 99

Network status, 105

Network storage system

- set up, 78

Network traffic

- checking, 105

Notifications

- alarm types, 91
- external alarms, 94
- system event types, 96

NTP server, 102

NVR, 36

NVR address

- change, 36

O

OSD settings, 117

Overwriting

- Protecting recorded files, 87

P

Password

- changing user password, 130
- default user passwords, 127
- enable/disable login password, 36

Playback

- bookmarks, 57
- changing playback speed, 60
- instant playback, 52
- interface overview, 49
- playing back archived files, 65
- pop-up menu description, 51
- search by event, 56
- search by time, 55
- search by video type, 55
- search results, 54
- snapshots, 58
- system log, 59
- using digital zoom, 60
- using the web browser, 73

Playback control panel

- description, 50

Playback control toolbar

- quick access, 51

Player

- using for playback, 65

Power up and down NVR, 11

PPPoE settings, 101

Pre-recording times

- maximum times, 151

- Preset tour
 - calling up, 46
- Preset tours
 - quick access, 42
- Presets
 - calling up, 44
 - quick access, 42
 - selecting, setting up and deleting, 43
- Privacy masking, 118
- Protecting recorded files, 87
- PTZ control panel
 - description, 42
- PTZ dome cameras
 - connecting to RS-485 port, 8
 - controlling remotely, 75
- PTZ protocols, 139
 - PTZ commands supported, 153

R

- Recorded files
 - lock/unlock, 87
 - Protect HDD, 89
- Recording
 - configuring settings, 81
 - protecting against overwriting, 87
 - recording schedules, 84
 - setting up HDD redundancy, 89
- Recording schedules
 - daily, 85, 86
 - defining, 84
 - external alarms, 87
- Remote alarm host settings, 104
- Remote control
 - connect to the NVR, 22
 - description, 20
- Resolution
 - change monitor resolution setup, 36
- RS-232 port
 - configuring, 121
- RTSP service port, 105

S

- S.M.A.R.T. information on a HDD, 112
- SAN, 78
- Sequencing cameras, 31, 35
- Setup wizard
 - using, 12
- Shadow tours
 - quick access, 42
 - setting up, 46
- Skip time
 - quick access, 51
- Snapshots
 - archiving, 64
 - capture remotely, 73
 - playback, 58
- SNMP protocol settings, 103
- Soft keyboard, 24

- Status icons
 - enable/disable display, 36
- System information
 - view, 123
- System logs
 - playback, 59
 - view, 125
- System notifications
 - event types, 96

T

- Text insertion
 - quick access to display, 51
 - search recorded video, 76
 - set up, 76
 - via local interface, 90
- Text overlay
 - browser, 78
- Time
 - configuring display, 38

U

- User privileges
 - camera configuration, 129
 - descriptions, 128
 - local configuration, 128
 - remote configuration, 129
- Users
 - adding a new user, 127
 - customizing user privileges, 128
 - deleting a user, 130
 - managing, 127
 - modifying user information, 130
 - user levels, 127

V

- Video format
 - PAL/NTSC, 11
- Video loss
 - setting up detection, 97
- Video output
 - change manually, 36
- Video tampering
 - setting up to detect, 98
- View system log, 125

W

- Web browser
 - accessing, 68
 - installing Active X, 67
 - local configuration of NVR, 70
 - remote configuration of NVR, 70
 - searching and playing back recorded video, 73
 - searching for event logs, 75
 - text insertion, 76

Index

text overlay, 78
video snapshot, 73
Wizard

enable/disable, 36

