





# TruVision TVC-6110-1 / TVC-6120-1 Camera User Manual

<b>Copyright</b>	© 2012 UTC Fire & Security. All rights reserved.
<b>Trademarks and patents</b>	The TruVision and Interlogix names and logo are trademarks of UTC Fire & Security. Other trade names used in this document may be trademarks or registered trademarks of the manufacturers or vendors of the respective products.
<b>Manufacturer</b>	UTC Fire & Security Americas Corporation, Inc. 2955 Red Hill Avenue, Costa Mesa, CA 92626-5923, USA Authorized EU manufacturing representative: UTC Fire & Security B.V. Kelvinstraat 7, 6003 DH Weert, The Netherlands
<b>Certification</b>	  N4131
<b>FCC compliance</b>	<b>Class A:</b> This equipment has been tested and found to comply with the limits for a Class A digital device, pursuant to part 15 of the FCC Rules. These limits are designed to provide reasonable protection against harmful interference when the equipment is operated in a commercial environment. This equipment generates, uses, and can radiate radio frequency energy and, if not installed and used in accordance with the instruction manual, may cause harmful interference to radio communications. Operation of this equipment in a residential area is likely to cause harmful interference in which case the user will be required to correct the interference at his own expense.
<b>ACMA compliance</b>	<b>Notice!</b> This is a Class A product. In a domestic environment this product may cause radio interference in which case the user may be required to take adequate measures.
<b>European Union directives</b>	<b>12004/108/EC (EMC directive):</b> Hereby, UTC Fire & Security declares that this device is in compliance or with the essential requirements and other relevant provisions of Directive 2004/108/EC
 	<b>2002/96/EC (WEEE directive):</b> Products marked with this symbol cannot be disposed of as unsorted municipal waste in the European Union. For proper recycling, return this product to your local supplier upon the purchase of equivalent new equipment, or dispose of it at designated collection points. For more information see: <a href="http://www.recyclethis.info">www.recyclethis.info</a> .
<b>Contact information</b>	For contact information, see <a href="http://www.utcfireandsecurity.com">www.utcfireandsecurity.com</a> or <a href="http://www.utcfssecurityproducts.eu">www.utcfssecurityproducts.eu</a> .

# Content

<b>Product overview</b>	<b>2</b>
Package Contents	2
Features	2
User guidelines	2
Product description	3
<b>Installation</b>	<b>4</b>
Attach the lens	4
Connect the cables	4
<b>Programming</b>	<b>6</b>
OSD control button	6
Access the Setup menu	6
Save changes	7
Select the lens type	7
Set shutter/AGC	8
Set white balance	9
Set backlight compensation (BLC)	10
Adjust the picture characteristics	10
Set ATR level	11
Set motion detection	11
Set the privacy mask area	12
Set Day/Night mode	13
Set image noise reduction	13
Set the camera ID	14
Set sync mode	14
Select the language	15
Reset camera settings	15
<b>Specifications</b>	<b>16</b>
Dimensions	16
<b>Menu Map</b>	<b>17</b>

# Product overview

The TVC-6110-1-N(-P)/ TVC-6120-1-N(-P) camera uses a digital signal processor (DSP) to process video signals. The camera includes a microcontroller to provide high-quality images with high-color reproduction and sharp pictures.

## Package Contents

The package contains the following:

- Box camera
- Lens mount cap
- C-Mount lens adapter

## Features

The camera includes the following features:

- Super HAD II (hole accumulated diode) technology
- High horizontal resolution 600 TVL
- Smart digital control automatic BLC (backlight compensation)
- Digital WDR (wide dynamic range)
- Advanced auto exposure system for both fixed iris and auto iris lenses to optimize the amount of light
- Internal synchronization
- Eight privacy mask areas to protect privacy concerns
- Signal-to-noise ratio better than 52 dB
- Long life and high reliability
- Isolated switching power 12 VDC and 24 VAC

## User guidelines

- Program the camera settings as much as possible before mounting the camera. Take appropriate safety precautions while completing programming after installation.
- Always use a 12 VDC or 24 VAC UL listed Class 2 power supply to power the camera.
- Do not use the camera over the temperature range specifications: -10°C to +50°C (14°F to 122°F)
- If the light source where the camera is installed experiences rapid, wide-variations in lighting, the camera may not operate as intended.

**WARNING:** To reduce the risk of fire or electronic shock, do not expose the camera to rain or moisture and do not remove the cover or back.

## Product description

Figure 1: Product description - TVC-6110-1-N(-P)

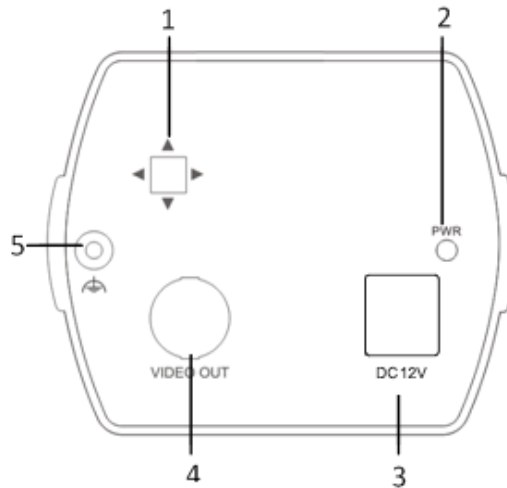

- 1. OSD control button
- 2. Power LED
- 3. 12 VDC Power
- 4. Video output
- 5. Ground

Figure 2: Product description – TVC-6120-1-N(-P)

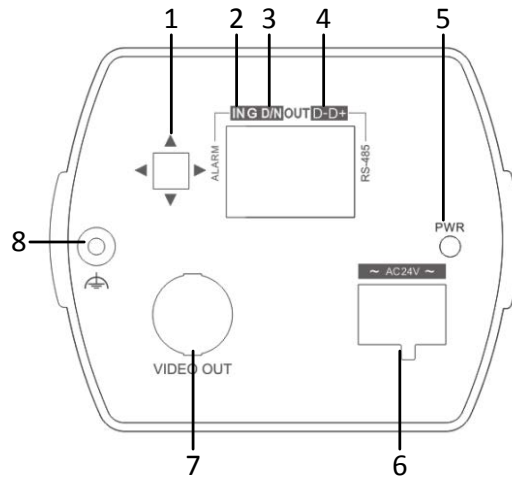

- 1. OSD control button
- 2. Alarm output/ground
- 3. D/N switch (3.3V)
- 4. RS-485 ports (D+, D-)
- 5. Power LED
- 6. 12 VDC/24 VAC dual power
- 7. Video output
- 8. Ground

# Installation

Please check the package contents and make sure that the device in the package is in good condition and all the assembly parts are included.

To install the camera you will need to prepare the mounting surface, mount the camera, attach the lens, and make cable connections.

**Note:** Before installing, please ensure that the mounting surface is strong enough to withstand three times the weight of the camera. If the mounting surface is not strong enough, the camera may fall and cause serious damage.

## Attach the lens

Refer to the instructions that came with the lens you purchased for complete installation instructions of that lens.

### To attach the lens:

1. Screw the lens clockwise onto the lens mount of the camera.

**Note:** Please prevent dust from entering between the lens mount and the lens.

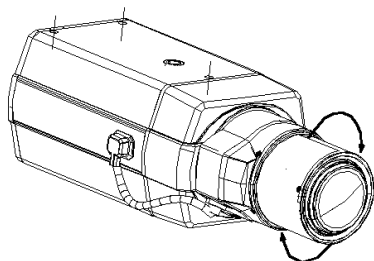

2. For optimal performance, please use an auto iris lens. Plug the auto-iris drive cable to the 4-pin interface on the side of the camera.

The 4 pins are: 1. Damper -; 2. Damper+; 3. Drive+; 4. Drive-

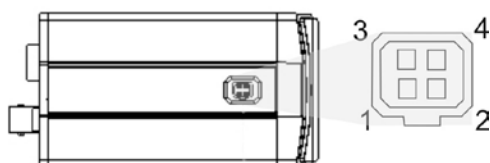

## Connect the cables

### To make cable connections:

1. Connect a coaxial cable from the camera's BNC connector to a CCTV monitor or video recording device.
2. Connect a 12 VDC or 24 VAC power supply to the power input.

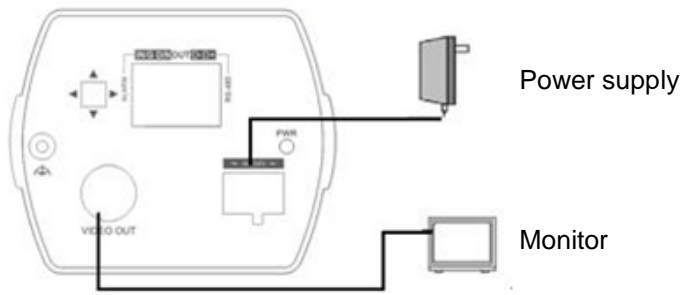

**Note:** TVC-6110-1-N(-P) is 12 VDC only.

# Programming

Once the camera hardware has been installed, the camera can then be configured.

Program the camera by attaching a standard video monitor to the system.

## To connect the monitor:

1. Plug the monitor output cable to the video monitor output connector.
2. Connect the BNC cable to the video monitor.
3. Press **Enter** on the OSD menu button to display the Setup menu. See Table 1 for instructions on how to move the cursor.

## OSD control button

The on-screen display (OSD) control button (see Figure 1) lets you manually control the camera functions. Table 1 below lists the OSD control button functions and describes their use.

Table 1: Using the OSD control button

Button direction	Description
Up	Moves the cursor upward to select an item
Left	Moves the cursor left to select or adjust the parameters of the selected item.
Right	Moves the cursor to the right to select or adjust the parameters of the selected item.
Down	Moves the cursor downward to select an item.
Enter	Press the center of the menu button to display the Setup menu. If the selected item has its own menu, press the button to enter a submenu.

## Access the Setup menu

The Setup menu provides access to the camera configuration options.

Figure 2: The Setup menu

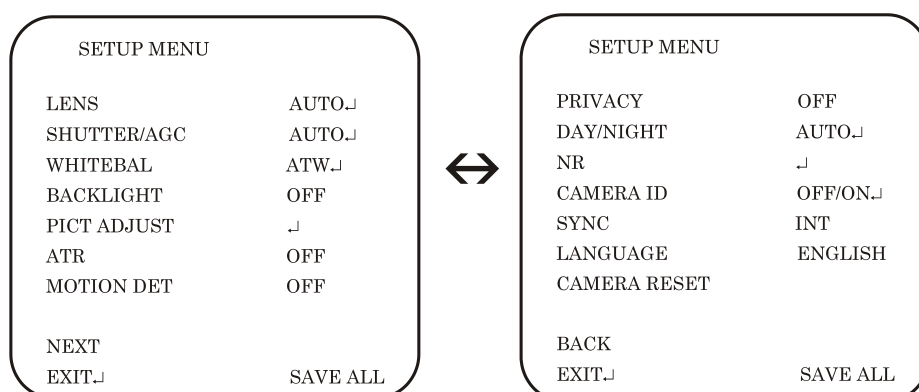



**Table 2: Setup menu description**

<b>Menu item</b>	<b>Description</b>
Lens	Defines autoiris or manual iris.
Shutter/AGC	Define the method of iris control, shutter and AGC.
White Bal	Defines the white balance (WB) set up.
Backlight	Defines the highlight compensation (HLC) and backlight compensation (BLC) set up.
Pict Adjust	Defines the image quality functions.
ATR	Defines the adaptive tone reproduction (ATR) set up.
Motion Det	Defines the motion detection set up.
Privacy	Defines privacy mask set up.
Day/Night	Defines the day/night (D/N) set up.
NR	Defines the digital noise reduction level.
Camera ID	Defines the camera ID displayed on-screen.
Sync	Displays the current synchronization mode.
Language	Defines the language of the OSD.
Camera Reset	Resets the camera to factory default settings.
Save All	Saves configuration changes made.
Exit	Exits the menu and returns to live mode.

**To access the Setup menu:**

1. Press the OSD control button to access the Setup menu and its submenus.
2. Push the button up/down to move between menu options.
3. Push the button left/right to select an option.
4. Select **Next** to move to the next Setup menu screen and **Back** to return to the previous Setup menu screen.
5. When in a sub menu, select **Return** to return to the previous menu.
6. To exit the Setup menu and return to normal camera operation mode, move the cursor to **Exit** at the bottom of the screen and press **Enter**.

## Save changes

Changes are not saved automatically. When all setup changes to the camera are done, move the cursor in the Setup menu to **Save All** and press Enter to save all changes made.

## Select the lens type

In the Setup menu, go to **Lens** and select the type of lens used with the camera, Auto or Manual. Select **Auto** to set the lens type to auto iris or select **Manual** for a manual lens. Manual is default. The Auto Iris or Manual menu appears.

### Manual menu:

Select a higher shutter speed value to see movement and a lower value to see clearer images. The shutter speed available are 1/50, 1/120, 1/250, 1/500, 1/1000, 1/2000, 1/4000 and 1/10000. The AGC value can be set between 6 and 44.8.

### Auto iris menu:

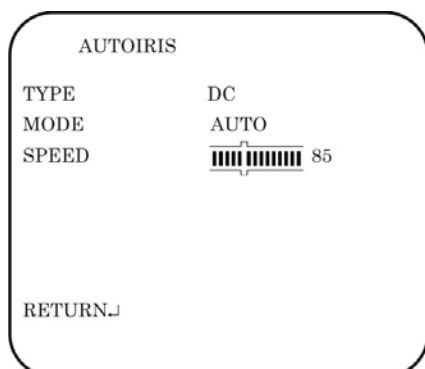

**Type:** Select the drive mode of the lens, DC or Video.

**Mode:** Select the iris control mode. Auto (automatically controlled depending on the light), Open (always open), or Closed (always closed).

**Speed:** When the mode is set to Auto, select the convergence speed of the iris between 0 and 255.

## Set shutter/AGC

In the Setup menu, go to **Shutter/AGC** and select the required iris control option, Manual or Automatic. Auto is default. The Manual or Auto menu appears:

### Automatic shutter menu:

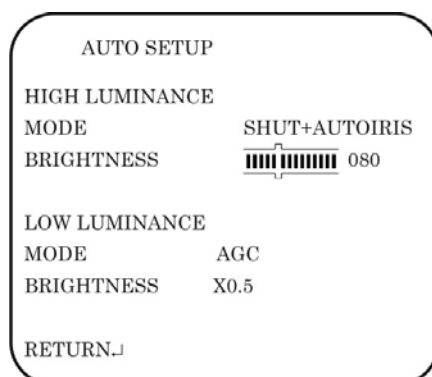

Select the parameters for high and low luminance conditions:

**High Luminance:** Sets the lux level for bright light conditions such as daylight.

**Mode:** When lens type is AUTO IRIS, you can choose SHUT+AUTO IRIS or AUTO IRIS mode. When the lens type is manual, only SHUT mode is available.

**Brightness:** Select the brightness level to which the iris and shutter speed will adjust automatically. The value ranges from 0 to 255.

**Low luminance:** Sets the lux level for low light conditions.

*Mode:* Only AGC is available.

*Brightness:* Adjust the brightness to X0.25, X0.50, X0.75 or X1.

**Manual shutter menu:**

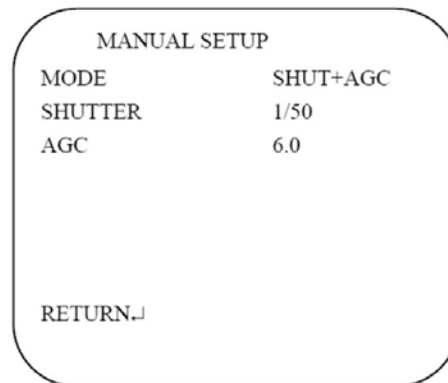

**Mode:** Only Shut/AGC available.

**Shutter:** Set the manual shutter to 1/60(1/50), 1/100(1/120), 1/250, 1/500, 1/1000, 1/2000, 1/4000 or 1/10000.

**AGC:** Set the gain level. A higher gain compensates for a brighter scene but noise increases. Manual AGC can be set to 6, 12, 18, 24, 30, 36, 42 or 44.8 dB.

## Set white balance

White balance (WB) tells the camera what the color white looks like. Based on this information, the camera will then continue to display all colors correctly even when the color temperature of the scene changes such as from daylight to fluorescent lighting, for example.

In the Setup menu, go to **White Bal** and select the options to be modified:

Menu Item	Description
ATW	<p>ATW (automatic tracing white balance) limits the color temperature range between 2,500 to 8,500°K to reduce excessive compensation for a large single-color object. Use it to automatically adjust the WB in real time as the lighting conditions change. It can be used for both indoor and outdoor locations.</p> <p>Set the following options:</p> <p><b>Speed:</b> Set the compensation speed. A lower value makes the AWB faster.</p> <p><b>Delay CNT:</b> Set the delay time between automatic adjustments of the AWB. A smaller value increases the frequency rate of AWB.</p> <p><b>ATW Frame:</b> X0.5, X1.0, X1.5, X2.0. Default is X2.0.</p> <p><b>Environment:</b> Select Indoor (ATW is compensated for low color temperature such as from incandescent lighting) or Outdoor (ATW is compensated for high color temperature such as from daylight). Default is Indoor.</p>
Push	<p>Like ATW, the Push function continually monitors/analyzes the color temperature of the incoming light and corrects the WB. However, Push</p>

Menu Item	Description
	has no limits between 1,800 to 10,500°K so it may over-compensate the WB for a large single-color object.
User1	This is a fixed white balance that is user-defined by blue and red gain parameters. Only use this function when there is steady light. Blue-gain from 0 to 255 Red- gain from 0 to 255
User2	This is a second fixed white balance that is user-defined by blue and red gain parameters. Only use this function when there is steady light. Blue-gain from 0 to 255 Red- gain from 0 to 255
Anti CR	The anti-color rolling mode function minimizes the color changes over long periods caused by very small differences between the flicker frequency of non-inverter fluorescent lights and the drive frequency of the image sensor devices.
Manual	Manually adjust the white balance by blue gain only. The red gain is automatically adjusted when the blue gain is changed. Only use this function when there is steady light. <b>Level UP:</b> Press Enter to increase the WB level. <b>Level DOWN:</b> Press Enter to decrease the WB level.
Push Lock	Press <b>Enter</b> to automatically adjust the white balance to the environment and lock it at this value.

## Set backlight compensation (BLC)

This feature tells the camera to adjust its total exposure (iris and shutter) to ignore the brightest areas of the image, and instead concentrate on darker areas.

In the Setup menu, go to **Backlight** and select the options to be modified:

**Off:** Option is disabled. Default setting.

**BLC (Backlight Compensation):** BLC can improve image quality when the background illumination is high. It prevents the object in the center from appearing too dark.

**HLC (Highlight Compensation):** HLC masks strong light sources, giving darker areas more detail. It is often used to help identify vehicle license plate numbers, for example.

## Adjust the picture characteristics

In the Setup menu, go to **Pict Adjust** and select the options to be modified.

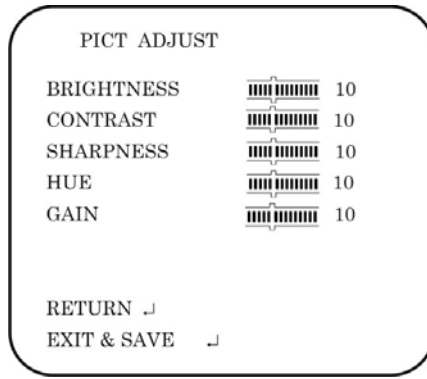

Set the camera image characteristics such as brightness, contrast, sharpness, hue, and saturation (called “Gain” here) of the picture. The parameters of each can be set between 0 and 255.

Use the mirror function to flip the camera image so that it is correctly orientated for viewing. The image can be flipped vertically, horizontally or horizontally-vertically (180 degrees). Default setting is Off.

## Set ATR level

This feature is similar to WDR (wide dynamic range). It is used when there are both bright and dark areas in the picture. It helps improve the contrast between objects.

In the Setup menu, go to **ATR** and select the desired luminance and contrast parameters.

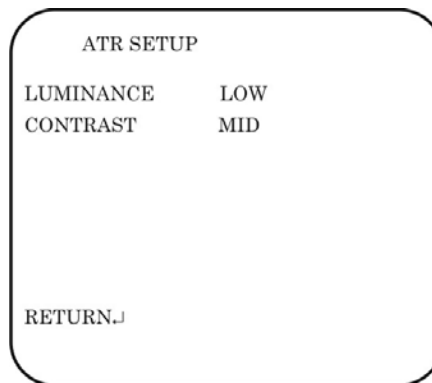

**Luminance:** Select the desired luminance level - High, medium, low (default)

**Contrast:** Select the desired contrast level - High, midhigh, mid (default), midlow, low

## Set motion detection

Use this function to identify when a moving object passes in front of the camera to activate an alarm. Up to four motion detection areas can be configured, each by size and location on-screen.

In the Setup menu, go to **Motion Det** and select the desired parameters. Default setting is Off.

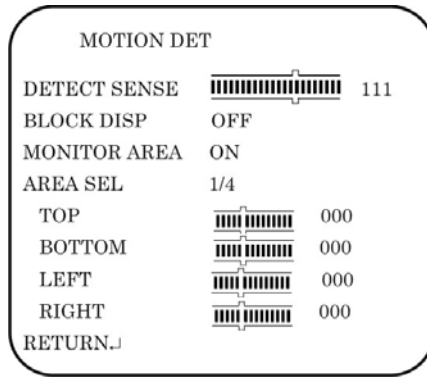

**Detect sense:** Set the sensitivity level for motion detection. A higher value is more sensitive.

**Block Disp:** When enabled, any movement detected will be tracked on-screen. Press Enter to enable or press the button again to cancel it.

**Monitor area:** When enabled, a square grid is displayed on-screen. It can only be enabled if *Block Disp* is also enabled.

**Area Sel:** Up to four motion-sensitive areas can be set. Set the size and position of each one.

## Set the privacy mask area

Use this function to mask out selected areas of the image. Up to eight privacy mask areas can be configured, each by size and location on-screen.

In the Setup menu, go to **Motion Det** and select the desired parameters.

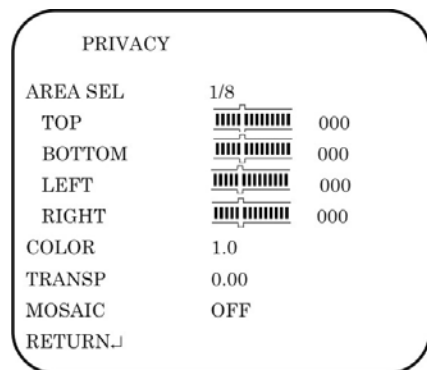

**Area Sel:** Up to eight privacy masks can be set. Select a mask and then set its size and position values using Top, Bottom, Left and Right.

**Color:** Select the color of the privacy mask.

**Transp:** Select the transparency shade of the privacy mask. The privacy mask is fully transparent at value 0.00 and not transparent at 1.00.

**Mosaic:** Enable this option to see the mask as a mosaic. Default is Off.

**Note:** Only four privacy mask areas can be set when motion detection is enabled.

## Set Day/Night mode

In the Setup menu, go to **Day/Night** and select the desired mode. The Day/Night mode has two options: Auto, Color and B/W.

Select Color to manually set the camera to color (day) mode.

Select Auto so that the camera can automatically switch between day (color) and night (black and white) mode.

### Auto mode:

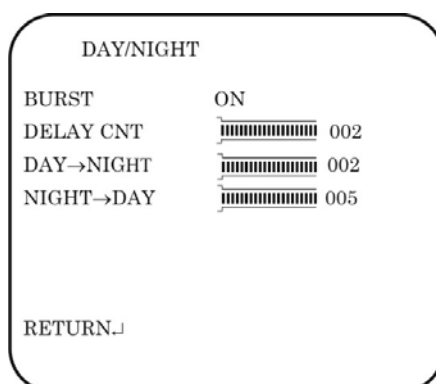

**Burst:** Enable/disable the color burst component of the video signal when the camera switches to B/W. ON mode maintains the same color signal in B/W so that the video signal provides better compatibility with certain color equipment. OFF mode removes the color burst signal B/W video and increase the total TV lines.

**Delay CNT:** This is the time in seconds before Day↔Night switches. A long delay response would be used, for example, to avoid switching from Night to Day mode when car headlights pass in front of the camera.

**Day→Night:** Set the threshold level on how dark it should be before switching from Day to Night mode. Lower (Higher) value makes the camera switched from Day to Night at lower (higher) illumination

**Night→Day:** Set the threshold level on how light it should be before switching from Night to Day mode.

---

**Caution:** If there is a minimal difference between the Day→Night and Night→Day values, then camera may switch between Day and Night mode repeatedly.

---

## Set image noise reduction

In the Setup menu, go to **NR** and select the desired mode. Set the noise reduction strength of the luminance signal (Y).

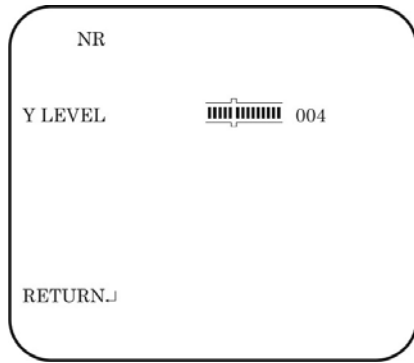

## Set the camera ID

In the Setup menu, go to **Camera ID** and press Enter to display the menu. The camera ID displayed on-screen can have up to 40 characters.

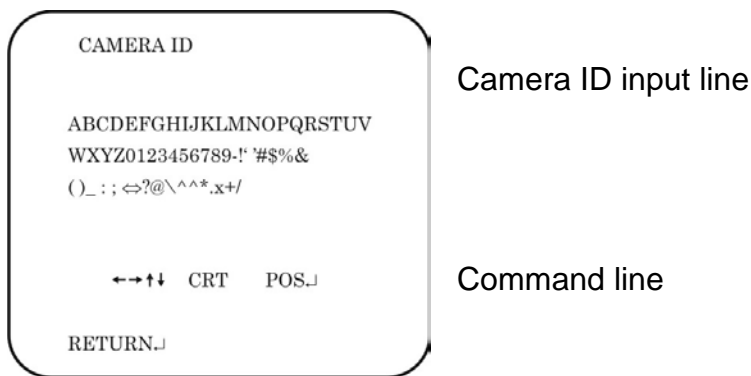

To enter a character, move the cursor to the desired character and press Enter to select it. It appears in the input line. Repeat the process until all characters are entered.

To move the character input position in the input line, move the cursor in the command line to ← or → and press Enter.

To clear the input line, move the cursor to CLR and press Enter.

To delete a character in the input line, select the character so that it blinks. Then move the cursor to CLR on the command line and press Enter.

To position the camera ID on-screen, move the cursor to POS and press Enter. The menu will then disappear on-screen and the camera ID will be displayed on the monitor. Use the menu button to move the camera ID to the desired position. Press Enter. The menu will reappear. Select Return to return to the previous menu.

## Set sync mode

Use the **Sync** menu to select the synchronization mode. Only one option is available: Internal.



## Select the language

Use this menu to select the OSD language.

In the Setup menu, go to **Language** and select the desired language. There are only two languages available, English and Japanese.

## Reset camera settings

Use this menu to reset the camera settings to factory default.

In the Setup menu, go to **Camera Reset** and press Enter.

# Specifications

Model	TVC-6110-1-N(P)	TVC-6120-1-N(P)
Pickup device	1/3" Super HAD CCD II	
Total pixels	NTSC: 811 x 508 / PAL: 795 x 596	
Effective pixels	NTSC: 768 x 494 / PAL: 752 x 582	
Resolution	600 TVL	
Synchronization system	Internal	Internal / Line up
Scanning system	2:1interlace	
IR cut	NA	Yes
S/N ratio	52 dB (AGC Off)	
Electronic shutter	PAL: 1/50 to 1/10,000 s NTSC: 1/60 to 1/10,000 s	
Minimum illumination	0.01 lux (F1.2, AGC X1)	
Video output	1 Vpp composite output (75 ohm/BNC)	
White balance	ATW/ PUSH/ USER1/ USER2/ ANTI CR/ MANUAL/ PUSH LOCK	
Lens type	C/CS-DC	
Power supply	12 VDC	24 VAC / 12 VDC
Current	160 mA	330mA
Power consumption	Max. 2.0 W	Max. 4.0 W
Operating temperature	-10 to +50 °C (14 to 122 °F)	
Weight	400 g (0.88 lbs)	

## Dimensions

(Units of measurement = mm)

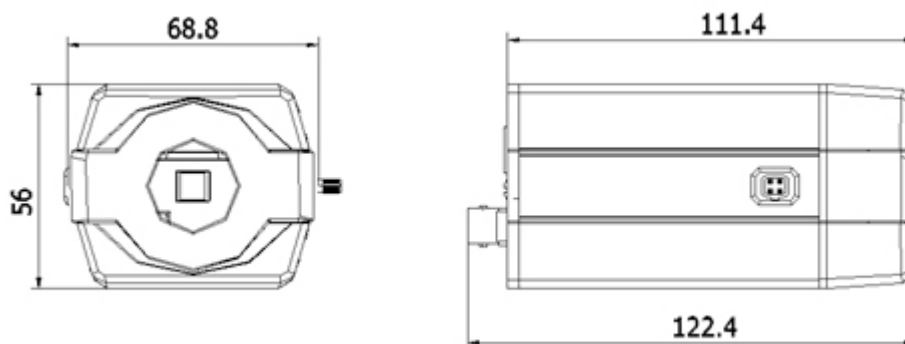

# Menu Map

