



D8020

D8020-R3

D8020WDM

D8020WDM-R3

D8030WDM

D8030WDM-R3

IFS Fiber Module Installation & Operation Instructions

D8000 SERIES

Same Pinout for Channels 1 - 8

Pin 1  Pin 8

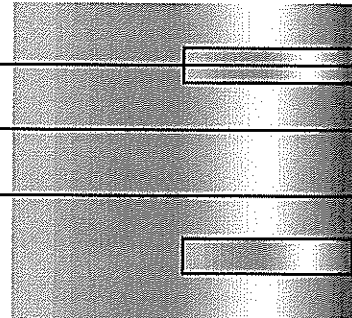
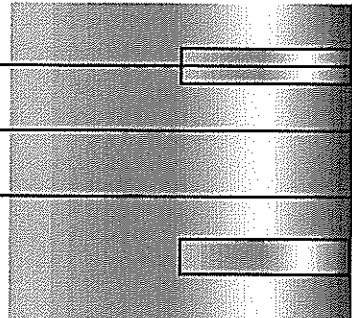
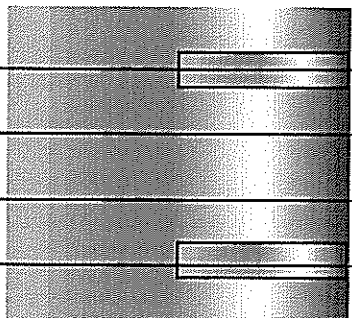
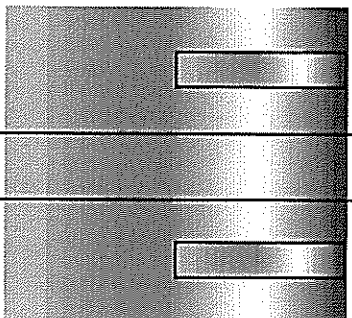
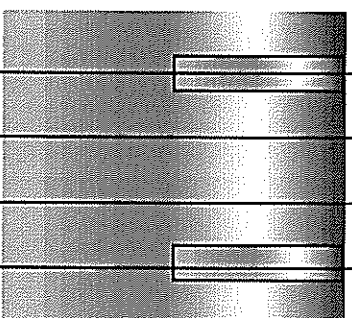
<p>RS232 DCE MODE</p>	 <p>4 — Ground 5 — Data Input 6 — Data Output</p>
<p>RS232 DTE MODE</p>	 <p>4 — Ground 5 — Data Output 6 — Data Input</p>
<p>RS422 MODE</p>	 <p>8 — + Data Output 7 — - Data Output 3 — + Data Input 2 — - Data Input</p>
<p>RS485 MODE 2 - WIRE</p>	 <p>3 — + Data Input / Output 2 — - Data Input / Output</p>
<p>RS485 MODE 4 - WIRE</p>	 <p>8 — + Data Output 7 — - Data Output 3 — + Data Input 2 — - Data Input</p>

D8000 SERIES

PLEASE NOTE:

The yellow RJ-45-to-screw clamp terminal strip data cables that come with this device must be used with **this device only**.

Due to a recent manufacturing issue, the cables that are provided with this device must be used with this device. These cables are not back compatible with older D8000 series devices. Please use these cables with this device only. We apologize for any inconvenience that this might cause.

D8000 Series

Data Cable and Wiring Diagram

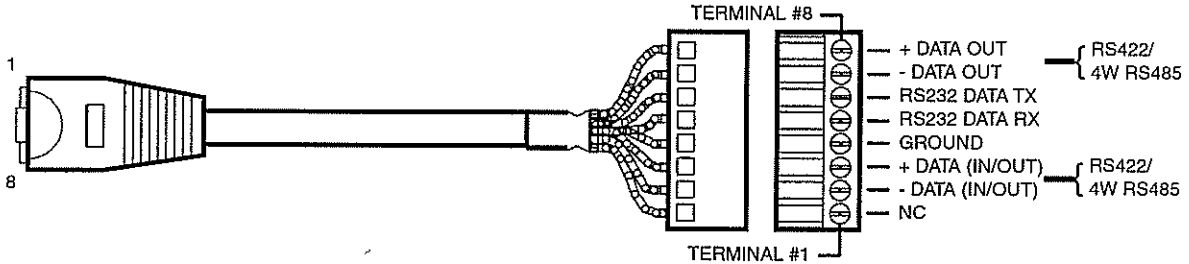

D8000 SERIES

RS-232 Data (DCE Mode)	<table border="0"> <tr><td>8</td><td>●</td><td></td></tr> <tr><td>7</td><td>●</td><td></td></tr> <tr><td>6</td><td>●</td><td>TX Data Output</td></tr> <tr><td>5</td><td>●</td><td>Rx Data Input</td></tr> <tr><td>4</td><td>●</td><td>Ground</td></tr> <tr><td>3</td><td>●</td><td></td></tr> <tr><td>2</td><td>●</td><td></td></tr> <tr><td>1</td><td>●</td><td></td></tr> </table>	8	●		7	●		6	●	TX Data Output	5	●	Rx Data Input	4	●	Ground	3	●		2	●		1	●	
8	●																								
7	●																								
6	●	TX Data Output																							
5	●	Rx Data Input																							
4	●	Ground																							
3	●																								
2	●																								
1	●																								
RS-232 Data (DTE Mode)	<table border="0"> <tr><td>8</td><td>●</td><td></td></tr> <tr><td>7</td><td>●</td><td></td></tr> <tr><td>6</td><td>●</td><td>TX Data Input</td></tr> <tr><td>5</td><td>●</td><td>Rx Data Output</td></tr> <tr><td>4</td><td>●</td><td>Ground</td></tr> <tr><td>3</td><td>●</td><td></td></tr> <tr><td>2</td><td>●</td><td></td></tr> <tr><td>1</td><td>●</td><td></td></tr> </table>	8	●		7	●		6	●	TX Data Input	5	●	Rx Data Output	4	●	Ground	3	●		2	●		1	●	
8	●																								
7	●																								
6	●	TX Data Input																							
5	●	Rx Data Output																							
4	●	Ground																							
3	●																								
2	●																								
1	●																								
RS-422 Data	<table border="0"> <tr><td>8</td><td>●</td><td>+ Data Out</td></tr> <tr><td>7</td><td>●</td><td>- Data Out</td></tr> <tr><td>6</td><td>●</td><td></td></tr> <tr><td>5</td><td>●</td><td></td></tr> <tr><td>4</td><td>●</td><td>Ground</td></tr> <tr><td>3</td><td>●</td><td>+ Data In</td></tr> <tr><td>2</td><td>●</td><td>- Data In</td></tr> <tr><td>1</td><td>●</td><td></td></tr> </table>	8	●	+ Data Out	7	●	- Data Out	6	●		5	●		4	●	Ground	3	●	+ Data In	2	●	- Data In	1	●	
8	●	+ Data Out																							
7	●	- Data Out																							
6	●																								
5	●																								
4	●	Ground																							
3	●	+ Data In																							
2	●	- Data In																							
1	●																								
2 - Wire RS-485 Data	<table border="0"> <tr><td>8</td><td>●</td><td></td></tr> <tr><td>7</td><td>●</td><td></td></tr> <tr><td>6</td><td>●</td><td></td></tr> <tr><td>5</td><td>●</td><td>Ground</td></tr> <tr><td>4</td><td>●</td><td>+ Data In/Out</td></tr> <tr><td>3</td><td>●</td><td>- Data In/Out</td></tr> <tr><td>2</td><td>●</td><td></td></tr> <tr><td>1</td><td>●</td><td></td></tr> </table>	8	●		7	●		6	●		5	●	Ground	4	●	+ Data In/Out	3	●	- Data In/Out	2	●		1	●	
8	●																								
7	●																								
6	●																								
5	●	Ground																							
4	●	+ Data In/Out																							
3	●	- Data In/Out																							
2	●																								
1	●																								
4 - Wire RS-485 Data	<table border="0"> <tr><td>8</td><td>●</td><td>+ Data Out</td></tr> <tr><td>7</td><td>●</td><td>- Data Out</td></tr> <tr><td>6</td><td>●</td><td></td></tr> <tr><td>5</td><td>●</td><td></td></tr> <tr><td>4</td><td>●</td><td>Ground</td></tr> <tr><td>3</td><td>●</td><td>+ Data In</td></tr> <tr><td>2</td><td>●</td><td>- Data In</td></tr> <tr><td>1</td><td>●</td><td></td></tr> </table>	8	●	+ Data Out	7	●	- Data Out	6	●		5	●		4	●	Ground	3	●	+ Data In	2	●	- Data In	1	●	
8	●	+ Data Out																							
7	●	- Data Out																							
6	●																								
5	●																								
4	●	Ground																							
3	●	+ Data In																							
2	●	- Data In																							
1	●																								

A

B

Simplex single mode fiber optic cable

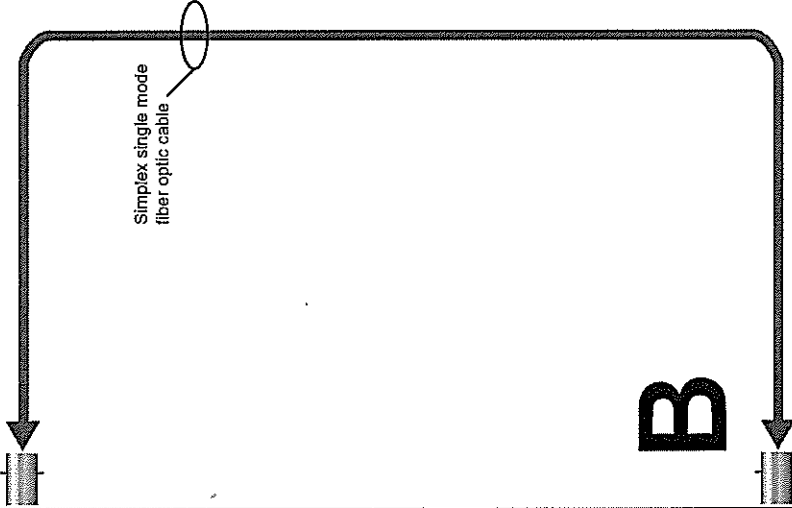

D8030WDMA
8 CHANNEL DATA TRANSCEIVER

International
Fiber
Systems
Incorporated
ifs
203.426.1180
www.ifs.com

SW	232	422	2W	4W
			485	485
1	OFF	OFF	ON	ON
2	ON	OFF	OFF	ON

POWER [| | - - 2
+ 12 VDC - 1

D8030WDMB
8 CHANNEL DATA TRANSCEIVER

International
Fiber
Systems
Incorporated
ifs
203.426.1180
www.ifs.com

SW	232	422	2W	4W
			485	485
1	OFF	OFF	ON	ON
2	ON	OFF	OFF	ON

POWER [| | - - 2
+ 12 VDC - 1

D8000 SERIES

NOTE: WITHOUT PROPER FIBER CONNECTION, LED'S DO NOT INDICATE CORRECT OPERATIONAL STATUS OF THE UNIT.

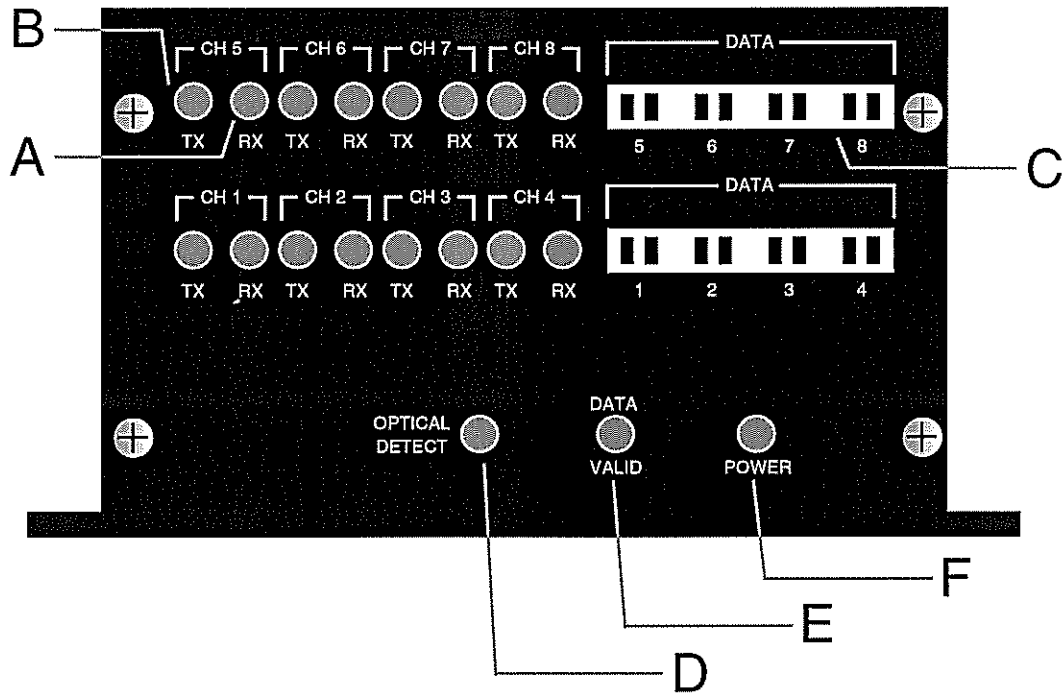

A	Data Receiver Indicator	LEDs changes from Red to Green
B	Data Transmit Indicator	
C	Data Format Switches	
D	Optical Detect Indicator	LEDs changes from Red to Green
E	Data Valid Indicator	
F	Power Indicator	LED Illuminates

DATA FORMAT SWITCH SETTINGS				
SWITCH	RS232	RS422	2-WIRE RS485	4-WIRE RS485
1	OFF	OFF	ON	ON
2	ON	OFF	OFF	ON

D8000 SERIES

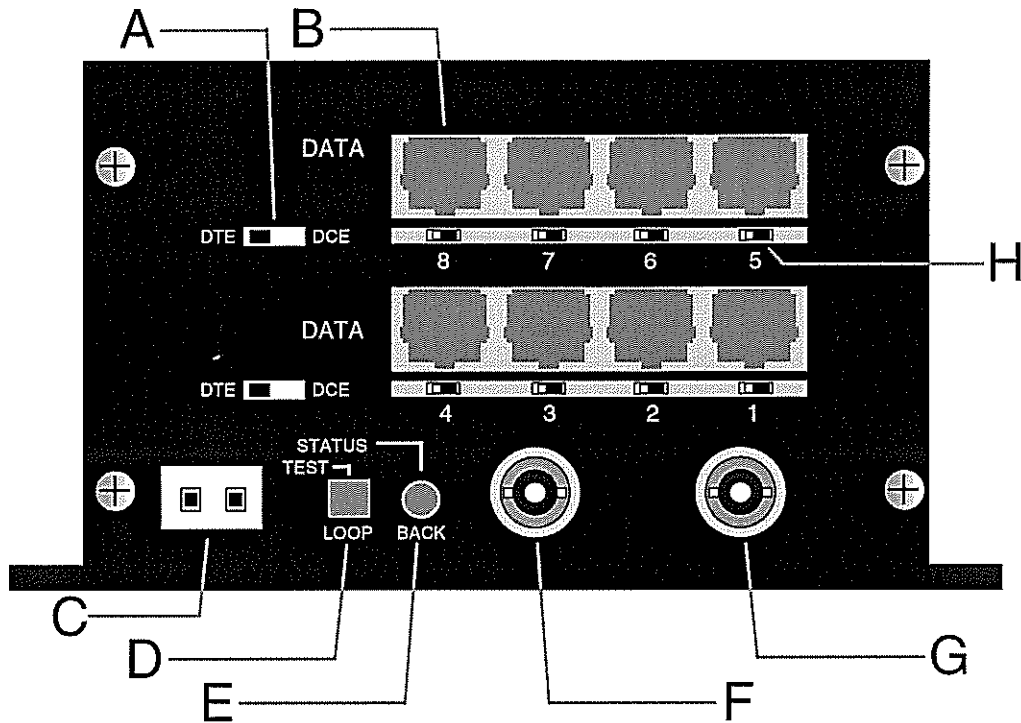

A	DTE/DCE Switch Legend for DCE/DTE Switches(See H)	
B	Data Input/Output Connectors	
C	Power Supply Connector	
D	TLoop Back Test Push - Button (verify link data)	
E	Loop Back Test Status Indicator	After Loop Back Test Push - Button is depressed: Green = Successful Test Red = Test Failure
F	Fiber Input (2 fiber versions ONLY; not present with WDM modles)	
G	Fiber Output (2 fiber version ONLY; fiber input / output f or WDM models)	
H	DTE/DCE Switches (one each for channels 1 - 8)	

NOTE: DTE/DCE switch applicable for RS232 ONLY.

FCC Compliance

This device complies with Part 15 of the FCC Rules. Operation is subject to the following two conditions: (1) This device may not cause harmful interference, and (2) this device must accept any interference received, including interference that may cause undesirable operation.

Changes or modifications not expressly approved by International Fiber Systems, Inc. could void the user's authority to operate the equipment.

NOTE: This equipment has been tested and found to comply with the limits for a Class A digital device, pursuant to Part 15 of the FCC Rules. These limits are designed to provide reasonable protection against harmful interference when the equipment is operated in a commercial environment. This equipment generates, uses and can radiate radio frequency energy and, if not installed and used in accordance with the instruction manual, may cause harmful interference to radio communications. Operation of this equipment in a residential area is likely to cause harmful interference in which case the user will be required to correct the interference at his own expense.

CLASS 1 LASER PRODUCT
(For purposes of IEC 60825-1)

Complies with FDA Performance Standard for Laser Products
Title 21
Code of Federal Regulations
Subchapter J



Comprehensive Lifetime Warranty

(a) Seller warrants to the original End User that products and any services furnished hereunder will be free from defects in material and workmanship as of the date of delivery, and will conform to Seller's published technical specifications. The foregoing shall apply only to failures to meet said warranties which appear within that period of time during which the Products are installed in their original installation for the original End User and operator of such Products; provided, however, that in the event of product discontinuance, warranty support is limited to five (5) years from the announcement of discontinuance. Notwithstanding the preceding sentence, the duration of the warranty period for products not manufactured by Seller (e.g., fiber optic cabling, test equipment, power supplies or batteries) shall be the warranty period offered by the original manufacturer, if any.

(b) The conditions of any tests shall be mutually agreed upon and Seller shall be notified of, and may be represented at, all tests that may be made. The warranties and remedies set forth herein are conditioned upon (a) proper storage, installation, use and maintenance, and conformance with any applicable recommendations of Seller and (b) Buyer promptly notifying Seller of any defects and, if required, promptly making the product available for correction.

(c) If any product or service fails to meet the foregoing warranties, Seller shall thereupon correct any such failure either at its option,

(i) by repairing any defective or damaged product or parts of the products, or (ii) by making available any necessary repaired or replacement products or parts thereof. Any repaired or replacement part or product shall be warranted for the remaining period of the original Warranty Period. Seller shall pay, or credit Buyer for, the cost of freight for all return shipments of products or parts to Buyer. Where a failure cannot be corrected by Seller's reasonable efforts, the parties will negotiate an equitable adjustment in price.

(d) The preceding paragraph sets forth the exclusive remedies for claims based on defect in or failure of products or services, whether the claim is in contract, indemnity, warranty, tort (including Seller's negligence), strict liability or otherwise and however instituted. Upon the expiration of the warranty period, all such liability shall terminate and BUYER shall have a reasonable time, within thirty days after the warranty period, to give written notice of any defects which appeared during the warranty period. The foregoing warranties are exclusive and in lieu of all other warranties, whether written, oral, implied or statutory. **NO IMPLIED OR STATUTORY WARRANTY OF MERCHANTABILITY OR FITNESS FOR PARTICULAR PURPOSE SHALL APPLY.** Seller does not warrant any products or services of others which BUYER has designated.

Contacting us

For help installing, operating, maintaining, and troubleshooting this product, refer to this document and any other documentation provided. If you still have questions, contact us during business hours (Monday through Friday, excluding holidays, between 5 a.m. and 5 p.m. Pacific Time).

Sales and support contact information

North America	Toll-free: 855.286.8889 in the US, including Alaska and Hawaii; Puerto Rico; Canada. Outside the toll-free area: 503.885.5700. E-mail: techsupport@interlogix.com
Europe	Select <i>Contact Us</i> at www.utcssecurityproducts.eu
Australia	security.tech.support@interlogix.com.au

Note: Be ready at the equipment before calling.

Online

Another great resource for assistance with your Interlogix product is our online publication library. To access the library, go to our website at the following location:

<http://www.interlogix.com/transmission>¹

1. Many Interlogix documents are provided as PDFs (portable document format). To read these documents, you will need Adobe Reader, which can be downloaded free from Adobe's website at www.adobe.com.

Product Disassembly Instructions for WEEE

Per European Directive 2002/95/EC Waste Electrical and Electronic Equipment

Required Tools:





- One number 2 Phillips (crosstip) screwdriver.**
- One number 2 flat screwdriver.**

For the enclosed box version:

- 1. Locate and remove box cover securement screws. Usually, but not limited to, at least 4 screws.**
- 2. Lift off box top cover.**
- 3. Locate and remove securement screws for printed circuit board.**
- 4. If there are multiple boards to the assembly, continue removing securement screws until none are left.**
- 5. Lift off printed circuit board.**
- 6. Disassembly of box version of product is complete.**

For rack version:

- 1. Locate and remove securement screws for printed circuit board. Usually, but not limited to, at least 4 screws.**
- 2. If there are multiple boards to the assembly, continue removing securement screws until none are left.**
- 3. Lift off printed circuit board(s).**
- 4. Disassembly of rack card version of product is complete.**

Copyright	© 2011 UTC Fire & Security. All rights reserved.
Trademarks and patents	Interlogix and IFS names and logos are trademarks of UTC Fire & Security. Other trade names used in this document may be trademarks or registered trademarks of the manufacturers or vendors of the respective products.
Manufacturer	UTC Fire & Security Americas Corporation, Inc. 2955 Red Hill Avenue, Costa Mesa, CA 92626-5923, USA Authorized EU manufacturing representative: UTC Fire & Security B.V. Kelvinstraat 7, 6003 DH Weert, The Netherlands
Certification	  N4131
ACMA compliance	Notice! This is a Class A product. In a domestic environment this product may cause radio interference in which case the user may be required to take adequate measures.
Canada	This Class A digital apparatus complies with Canadian ICES-003. Cet appareil numérique de la classe A est conforme à la norme NMB-003 du Canada.
European Union directives	2004/108/EC (EMC directive): Hereby, UTC Fire & Security declares that this device is in compliance with the essential requirements and other relevant provisions of Directive 2004/108/EC.
 	2002/96/EC (WEEE directive): Products marked with this symbol cannot be disposed of as unsorted municipal waste in the European Union. For proper recycling, return this product to your local supplier upon the purchase of equivalent new equipment, or dispose of it at designated collection points. For more information see: www.recyclethis.info .
Contact information	For contact information, see www.interlogix.com .