



GE Security

**466-1873-01 Rev B
July 2004**

www.gesecurity.com

**Part No:
60-875
60-910 (Not investigated for use by UL)
600-1012**

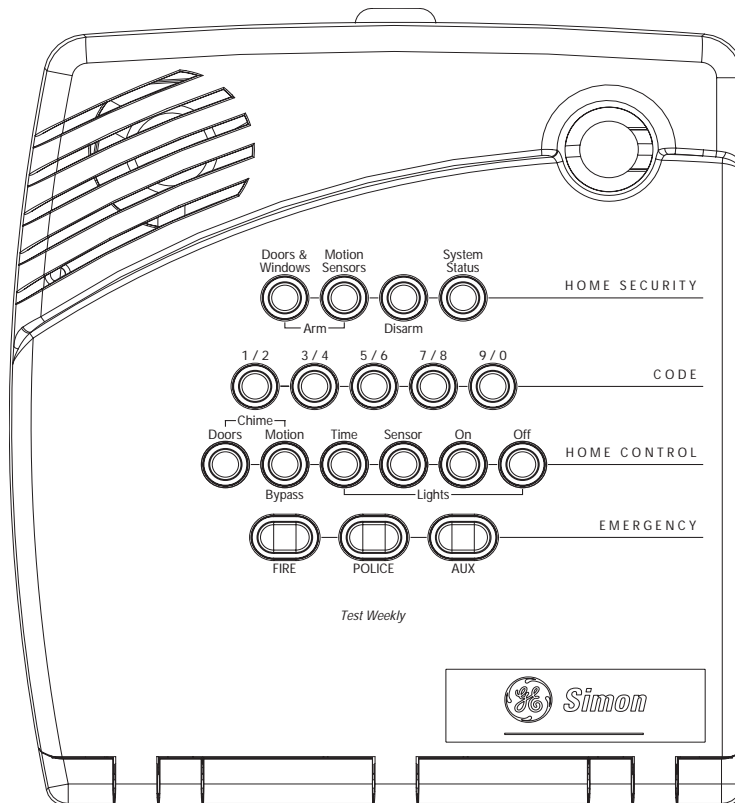

Simon Security System

Installation Instructions

FCC Notices

FCC Part 15 Information to the User

Changes or modifications not expressly approved by GE Security can void the user's authority to operate the equipment.

FCC Part 15 Class B

This equipment has been tested and found to comply with the limits for a Class B digital device, pursuant to part 15 of the FCC Rules. These limits are designed to provide reasonable protection against interference in a residential installation.

This equipment generates, uses, and can radiate radio frequency energy and, if not installed and used in accordance with the instructions, may cause harmful interference to radio communications. However, there is no guarantee that interference will not occur in a particular installation.

If this equipment does cause harmful interference to radio or television reception, which can be determined by turning the equipment off and on, the user is encouraged to try to correct the interference by one or more of the following measures:

- Reorient or relocate the receiving antenna.
- Increase the separation between the equipment and receiver.
- Connect the affected equipment and the panel receiver to separate outlets, on different branch circuits.
- Consult the dealer or an experienced radio/TV technician for help.

FCC ID: B4Z-787E-SIMON

ACTA Part 68

This equipment complies with Part 68 of the FCC Rules. Located on this equipment is a label that contains, among other information, the FCC registration number and the ringer equivalence number (REN) for this equipment. If requested, this information must be provided to the telephone company.

FCC Part 68 Registration No. B4ZUSA-27621-AL-E REN: 0.2B

The REN is used to determine the maximum number of devices that may be connected to your telephone line. Excessive RENs on a telephone line may result in devices not ringing in response to an incoming call. In most areas, the sum of all device RENs should not exceed five (5.0). To be certain of the number of devices that may be connected to a line, as determined by the total RENs, contact the local telephone company. For products approved after July 23, 2001, the REN for this product is part of the product identifier that has the format US:AAAEQ##TXXXX. The digits represented by ## are the REN without a decimal point (e.g., 03 is a REN of 0.3). For earlier products, the REN is separately shown on the label.

A plug and jack used to connect this equipment to the premises wiring and telephone network must comply with the applicable FCC Part 68 rules and requirements as adopted by ACTA. A compliant telephone cord and modular plug is provided with this product. It is designed to be connected to a compliant modular jack that is also compliant. See the Installation Instructions for details.

Alarm dialing equipment must be able to seize the telephone line and place a call in an emergency situation. It must be able to do this even if other equipment (telephone, answering system, computer modem, etc.) already has the telephone line in use. To do so, alarm dialing equipment must be connected to a properly installed RJ31X jack that is electrically in series and ahead of all other equipment attached to the same telephone line. Proper installation is depicted in the following diagram. If you have any questions concerning these instructions, consult your local telephone company or a qualified installer about installing an RJ31X jack and alarm dialing equipment for you.

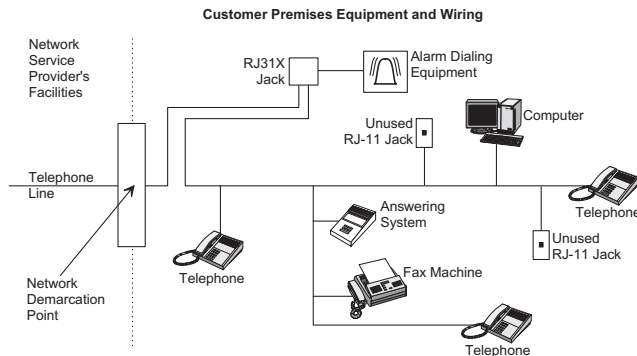

If this equipment causes harm to the telephone network, the telephone company may temporarily disconnect your service. If possible, you will be notified in advance. When advance notice is not practical, you will be notified as soon as possible. You will also be advised of your right to file a complaint with the FCC.

The telephone company may make changes in its facilities, equipment, operations, or procedures that could affect the operation of the equipment. You will be given advance notice in order to maintain uninterrupted service.

If you experience trouble with this equipment, please contact the company that installed the equipment for service and/or repair information. The telephone company may ask you to disconnect this equipment from the network until the problem has been corrected or you are sure that the equipment is not malfunctioning.

This equipment may not be used on coin service provided by the telephone company. Connection to party lines is subject to state tariffs.

Patent Information

This product and the use of this product may be covered by one or more of the following patents: 5,805,063, 5,872,512, 5,942,981, 5,686,896, 5,686,885, 4,855,713. Except expressly provided herein, the purchase of this product shall not constitute a license or otherwise provide a right to practice a method covered by any of the identified patents. GE Security hereby grants the purchaser of this product a limited, non-exclusive license to practice the methods patented in the identified patents solely with products manufactured, sold or licensed by GE Security. This license grant does not extend to the use of unlicensed, third party products with this product.

Canada Notice

The Canadian Department of Communications label identifies certified equipment. This certification means that the equipment meets certain telecommunications network protective, operational, and safety requirements. The department does not guarantee the equipment will operate to the user's satisfaction.

Before installing this equipment, users should ensure that it is permissible to be connected to the facilities of the local telecommunications company. The equipment must also be installed using an acceptable method of connection. In some cases, the company's inside wiring associated with a single-line individual service may be extended by means of a certified connector assembly (telephone extension cord). The customer should be aware that compliance with the above conditions may not prevent degradation of service in some situations.

Repairs to certified equipment should be made by an authorized Canadian maintenance facility designated by the supplier. Any repairs or alterations made by the user to this equipment, or equipment malfunctions, may give the telecommunications company cause to request the user to disconnect the equipment.

For your protection, make sure that the electrical ground connections of the power utility, telephone lines, and internal metallic water pipe system, if present, are connected together



Do not attempt to make connections yourself. Contact the appropriate electrician or electric inspections authority.

The Load Number (LN) assigned to each terminal device denotes the percentage of the total load to be connected to a telephone loop which is used by the device, to prevent overloading. The termination on a loop may consist of any combination of devices subject only to the requirement that the total of the LNs of all the devices does not exceed 100. Load Number: .1 The term "IC:" before the certification/registration number only signifies that the Industry Canada technical specifications were met. IC: 867A 787SIMON

"AVIS: - L'étiquette du ministère des Communications du Canada identifie le matériel homologué. Cette étiquette certifie que le matériel est conforme à certaines normes de protection, d'exploitation et de sécurité des réseaux de télécommunications. Le ministère n'assure toutefois pas que le matériel fonctionnera à la satisfaction de l'utilisateur.

Avant d'installer ce matériel, l'utilisateur doit s'assurer qu'il est permis de le raccorder aux installations de l'entreprise locale de télécommunication. Le matériel doit également être installé en suivant une méthode acceptée de raccordement. Dans certains cas, les fils intérieurs de l'entreprise utilisés pour un service individuel à ligne unique peuvent être prolongés au moyen d'un dispositif homologué de raccordement (cordon prolongateur téléphonique interne). L'abonné ne doit pas oublier qu'il est possible que la conformité aux conditions énoncées ci-dessus n'empêchent pas la dégradation du service dans certaines situations. Actuellement, les entreprises de télécommunication ne permettent pas que l'on raccorde leur matériel à des jacks d'abonné, sauf dans les cas précis prévus par les tarifs particuliers de ces entreprises.

Les réparations de matériel homologué doivent être effectuées par un centre d'entretien canadien autorisé désigné par le fournisseur. La compagnie de télécommunications peut demander à l'utilisateur de débrancher un appareil à la suite de réparations ou de modifications effectuées par l'utilisateur ou à cause de mauvais fonctionnement.

Pour sa propre protection, l'utilisateur doit s'assurer que tous les fils de mise à la terre de la source d'énergie électrique, des lignes téléphoniques et des canalisations d'eau métalliques, s'il y en a, sont raccordés ensemble. Cette précaution est particulièrement importante dans les régions rurales.

Avertissement. - L'utilisateur ne doit pas tenter de faire ces raccordements lui-même; il doit avoir recours à un service d'inspection des installations électriques, ou à un électricien, selon le cas".

Une note explicative sur les indices de charge (voir 1.6) et leur emploi, à l'intention des utilisateurs du matériel terminal, doit être incluse dans l'information qui accompagne le matériel homologué. La note pourrait être rédigée selon le modèle suivant:

"L'indice de charge (IC) assigné à chaque dispositif terminal indique, pour éviter toute surcharge, le pourcentage de la charge totale qui peut être raccordée à un circuit téléphonique bouclé utilisé par ce dispositif. La terminaison du circuit bouclé peut être constituée de n'importe quelle somme des indices de charge de l'ensemble des dispositifs ne dépassant pas 100."

L'Indice de charge de cet produit est _____.



©2004 GE Security. Simon is a registered trademark of GE Security. All other trademarks are properties of their owners.

All rights reserved.

1275 Red Fox Road
Arden Hills, MN 55112
Technical Support: 800-777-2624

Contents

About This Manual 1

Special Installation Requirements	1
UL Listed Installations.....	1
SIA System Requirements	2
Central Station Reporting	3
UL Canada Listed Installations.....	3
California State Fire Marshall Listed Installations	3

Planning the Installation 4

Standard Panel	4
----------------------	---

System Overview 4

System Components	4
Control Panel	4
System Devices.....	5

Planning Sensor Types & Locations 7

Device Locations	7
Control Panel	7
Remote Handheld Touchpad.....	8
QS1500 Keypad.....	8
Keychain Touchpad	8
Dialog Telephone Interface Module	8
X10 Modules.....	8
House Code and Unit Numbers	8
Manually Controlling Lights	8

Installing the System 9

Materials Needed	9
Opening the Panel Cover and Chassis	9
Mounting the Panel.....	10
Wall Mounted Panel.....	10
Tabletop Mounted Panel	10
Connecting Hardwire Devices.....	11
AC Terminals.....	11
HWIN1, HWIN2, and DCOUT Terminals	11
Wiring Interior Sirens	11
LD105 Hardwire Interior Siren.....	12
Wiring Exterior Sirens	12
Hardwire Exterior Siren with Supervision.....	12
Hardwire Exterior Siren without Supervision	13
Wiring Hardwire Contacts	13
Wiring a Phone Line to the Panel	13
Full Line Seizure.....	14

No Line Seizure	15
Wiring the Power Transformer	15
Powering Up the Panel	15
Installing the Panel Backup Battery	15
Applying AC Power	16
Installing X10 Modules	16
Lamp and Appliance Modules	16
Universal Module	16
Sensor Installation	17

Programming

17

Entering Program Mode	17
Exiting Program Mode	17
Reset Memory to the Factory Defaults	17
Set the Clock	17
Adding (Learning) Sensors	18
X10 Module Operation	20
Ethernet Interface Module	21
Requirements	21
Activate the Ethernet Interface Module	21
Numbered Options	22
Option 01: Panel Piezo Beeps	22
Option 02: Panel Voice	23
Option 03: Latchkey	24
Option 04: Primary Phone Number	24
Option 05: Secondary Phone Number	25
Option 06: Downloader Phone Number	25
Option 07: Account Number	25
Option 08: Phone Lock	26
Option 09: Downloader Code	26
Option 10: Entry Delay	26
Option 11: Exit Delay	27
Option 12: Phone 1 Reports	27
Option 13: Phone 2 Reports	27
Option 14: DTMF Dialing	28
Option 15: No Activity Timeout	28
Option 16: Auto Phone Test	29
Option 17: Dialer Delay	29
Option 18: Alarm Cancel Report	29
Option 19: RF Timeout	30
Option 20: Manual Phone Test	30
Option 21: Opening Reports	30
Option 22: Closing Reports	31
Option 23: Force Armed Report	31
Option 24: AC Power Failure Report	31
Option 25: CPU Low Battery Report	32
Option 26: Fail to Communicate	32
Option 27: Ring/Hang/Ring	32
Option 28: No Delay from Keychain Touchpad	33
Option 29: Panel Piezo Alarms	33
Option 30: Panel Panic Alarms	34
Option 31: Downloader Enable	34

Option 32: 300 Baud.....	34
Option 33: Audio Verification	35
Option 34: Fail to Open Report	35
Option 35: Fail to Close Report.....	35
Option 36: Sensor Activated Light Lockout Start Time	36
Option 37: Sensor Activated Light Lockout Stop Time	36
Option 38: Auto Arm.....	37
Option 39: Siren Timeout	37
Option 40: Trouble Beeps.....	38
Option 41: Chime Voice	38
Option 42: Speaker Level.....	38
Option 43: Numeric Pager/Voice Event Notification Phone Number	39
Option 44: Numeric Pager/Voice Event Notification Phone 3 Reports.....	39
Option 45: Sensor Alarm Restoral Report.....	40
Option 46: Fire Shutdown - AVM	40
Option 47: AVM Mode.....	41
Option 48: Panic Talk - AVM.....	41
Option 49: Arming LEDs Shutdown	41
Option 50: RF Jam Detect	42
Option 51: 24 Hour Sensor Tamper.....	42
Option 52: Unvacated Premises.....	42
Option 53: Hardwire Siren Supervision.....	43
Option 54: Access Code Length	43
Option 55: Status Beep Volume.....	44
Option 56: Call Waiting.....	44
Option 57: Supervisory/Tamper Report.....	44
Option 58: Remote Touchpad Arming.....	45
Option 59: Exit Extension	45
Option 60: Secure Arming.....	45
Option 61: Demo Mode.....	46
Option 62: Supervisory Protest.....	46
Option 63: 24 Hour Time.....	46
Option 64: No Arm on Panel Low Battery	47
Option 65: No Usage Report	47
Option 66: External Siren Delay.....	47
Option 67: Quick Exit.....	48
Option 68: Swinger Shutdown.....	48
Option 69: SIA Limits	48
Option 70: Not Available	49
Option 71: Programming Report	49
Option 72: Supervisory Time.....	49
Option 73: Modem Sensitivity.....	50
Option 74: Silent Panel Police Panic	50
Option 75: VOX Mic Gain	50
Option 76: VOX Gain Range.....	51
Option 77: Manual Mic Gain.....	51
Option 78: VOX Receiver Gain.....	51
Option 79: Panel Cover Tamper	52
Option 80: Alarm Report Verification	52
Option 81: Heating Set Point.....	52
Option 82: Cooling Set Point.....	53
Option 83: X10/RF Light Control	53

Option 84: European Compliance.....	53
Option 85: Smoke Supervision.....	53
Option 86: Fire Alarm Verify.....	54
Option 87: 2-Way RF Touchpad Voice.....	54
Option 88: Custom Defaults.....	54
Option 89: Serial Port Protocol.....	54
Option 90: Comm Channel 1 Reports.....	55
Option 91: Comm Channel 2 Reports.....	55
Option 92: Comm Channel 3 Reports.....	55
Option 93: DTIM Reports Phone 1.....	56
Option 94: DTIM Reports Phone 2.....	56
Option 95: Not Available.....	56
Option 96: HWIN2 Output Function.....	57
Option 97: HWIN1 Output Function.....	57
Programming System Access Codes.....	57

Testing the System **58**

Control Panel.....	58
Sensor Testing.....	59
Improving Sensor/Panel Communication.....	61
Antenna.....	61
If a Sensor Fails the Sensor Test.....	61
Phone Communication.....	61
Off-Site Phone Operation.....	62
Central Station Communication.....	62
Dialog Telephone Interface Module (DTIM).....	63
Pager Communication.....	63
2-Way Voice Operation.....	64
Voice Event Notification.....	65
RF Thermostat Operation.....	65
Personal Help Button.....	65
X10 Operation.....	65
Manual Lamp Module Control.....	65
X10 Siren and Lamp Module Functions.....	66

Emergency Planning **66**

Appendix A: **68**

Troubleshooting.....	68
System Status.....	68
Control Panel.....	68
Options (Programmable by the homeowner).....	68
Sensors.....	68
X10 Modules.....	69

Appendix B: System Configuration **70**

Alphabetical Listing of Sensor Names.....	70
Cross-Zoning.....	72
System Access Codes.....	73
Option Settings.....	73

Appendix C: Software Release Notes **77**

Software Version 4.0..... 77
Dialog Telephone Interface Module (DTIM) 77
Ethernet Interface Module 77
Option Changes..... 77
New Options 77

Specifications **78**

Quick Reference Table **Back Page**

About This Manual

This manual provides information for planning, installing, programming, and testing this security system. When necessary, this manual refers you to other documentation included with compatible devices.

Planning sheets are included for you to record sensor locations and software programming settings.

Special Installation Requirements

This security system can be used as a fire warning system, an intrusion alarm system, an emergency notification system, or any combination of the three.

Some installations may require configurations dictated by city/state codes, insurance, or Underwriter's Laboratories (UL). This section describes the various component and configuration listings.

UL Listed Installations

This section describes the requirements for UL Listed installations.

Basic System

- Control Panel:
 - 60-875-95R (basic panel)
 - 60-875-01-95R (with *2-way voice)
 - 60-875-10-3 (with *transmitter)
 - 60-875-11-3 (with *2-way voice and *transmitter)
 - 600-1012 (Broadband Ready)
- Backup Battery 6V 1.2 AH (34-025) (Portalac model # PE6V1.2)
- Standard Class II 9 VAC, 700 mA Power Transformer (22-109-ITI) or Class II 9 VAC, 700 mA Line Carrier Power Transformer (22-129-ITI). Obtained through GE Security.
- Hardwire Siren (13-046)

Household Burglary Alarm System Unit (UL 1023)

Basic system, plus:

- Hardwire Magnetic Contact (13-068 or 13-071) or Wireless Learn Mode Door/Window Sensor (60-670)
- Option 01: Panel Piezo Beeps set to on
- Option 10: Entry Delay set to 45 seconds or less
- Option 11: Exit Delay set to 60 seconds or less
- Option 19: RF Timeout set to less than 24 hours
- Option 29: Control Panel Alarms turned on
- Option 38: Auto Arm set to on
- Option 39: Siren Timeout set to 4 minutes or more
- Option 40: 7 set to on
- Option 50: RF Jam Detect set to on
- Option 53: Hardwire Siren Supervision set to on if Option 29: Control Panel Alarms is set to off
- Option 59: Exit Extension set to off
- Option 67: Quick Exit set to off

Household Fire Warning System (UL 985)

Basic system, plus:

- Wireless Smoke Sensor 60-848-95 learned into sensor group 26
- Option 01: Panel Piezo Beeps turned on

Note

* Not investigated for use by UL.

- Option 29: Control Panel Alarms set to on
- Option 39: Siren Timeout set to 4 minutes or more
- Option 40: Trouble Beeps set to on
- Option 50: RF Jam Detect set to on
- Option 53: Hardwire Siren Supervision set to on if Option 29: Control Panel Alarms is set to off
- Option 85: Smoke Supervision must be set to on

UL 1023 & 985 24-Hour Backup

- For 24-hour backup, the total current draw for all connected devices is limited to 25 mA (during normal standby conditions) using a 1.2 AH battery.

UL 1635 Digital Alarm Communicator System

Same as UL 1023 & 985, plus:

- Option 12: Phone 1 Reports set to 0 or 1
- Option 16: Auto Phone Test set to 001
- Option 19: RF Timeout set to less than 4 hours
- Option 24: AC Power Failure Report set to on
- Option 25: CPU Low Battery Report set to on
- Option 26: Fail to Communicate set to on
- Option 50: RF Jam Detect set to on
- Option 10 and 17: Entry Delay plus the Dialer Delay must not exceed 60 seconds

Note

These option settings are in addition to UL 1023 and 985 and are required only if the system is set up for Central station reporting.

SIA System Requirements

SIA system requirements are the same as those described for a UL Listed Basic System on page 1, plus:

- If multiple annunciation is required, use Hardwire Siren part no.13-046.

Note

UL requirements take priority over SIA requirements.

SIA Setting Requirements

The following table describes programming requirements to meet ANSI-SIA CP-01.

Opt. #	Function	Programming Page Reference	Testing Page Reference	Default Setting	Required Setting
10	Entry Delay	26	58	30 sec.	30-254 sec.
11	Exit Delay	27	58	60 sec.	45-254 sec.
17	Dialer Delay	29	58	30 sec.	15-45 sec.
38	Auto Arm	37	58	On	On
45	Sensor Alarm Restoral Report	40	58	Off	3
52	Unvacated Premises	42	58	On	On
56	Call Waiting	44	58	Off	On if reporting to central station and customer has call waiting service
59	Exit Extension	45	58	On	On
68	Swinger Shutdown	48	58	On (one trip)	On (one trip)
69	SIA Limits	48	58	On	On
86	Fire Alarm Verify	54	58	Off	On

Opt. #	Function	Programming Page Reference	Testing Page Reference	Default Setting	Required Setting
N/A	Duress/Panic Code	57	58	Disabled	Disabled
N/A	Cross Zoning	71	58	Disabled	Enabled for PIRs

The following table describes non-programmable (hard coded) system operation as required to meet ANSI-SIA CP-01 and is provided only for your reference.

Function	Operation
Silent Exit	All annunciators enabled
Remote Arming Exit Time & Progress Annunciation	All annunciators enabled
Abort Annunciation	Enabled
Cancel Report Annunciation	Enabled
Recent Closing	Enabled (2 minute window)
Exit Error	Enabled
Restoration of Power	Panel resumes operation in same arming state and disregards alarm signals from sensors for the first 60 seconds after power restoration

Central Station Reporting

Note

The communication path between the panel and the receivers listed below can be either DACT or internet. One is not a backup for the other.

The panel has been tested with the following central station receivers using SIA and Contact ID reporting formats:

- Radionics D6600 Central Station Receiver
- Sur-Gard Central Station Receiver with models SG-DRL2A and SG-CPM2
- CS5000 Digital Alarm Communicator Receiver
- Osborne-Hoffman (OH2000E) Network Receiver

UL Canada Listed Installations

This section describes the requirements for CUL (UL Canada) Listed installations.

Canadian Standards CSA Certified Accessories

Residential Burglary Alarm System Unit (ORD-C1023-1974)

Basic system as described for “UL 1023 Listed Installations” plus:

- Hardwire Magnetic Contact (13-068 or 13-071) or Wireless Learn Mode Door/Window Sensor (60-670)
- Option 39: Siren Timeout set to 5 minutes or more

Residential Fire Warning System Control Unit (ULC-S545-M89)

Basic system as described for “UL 985 Listed Installations” plus:

- Wireless Smoke Sensor 60-848-95 learned into sensor group 26
- Option 39: Siren Timeout set to 5 minutes or more
- For 24-hour backup, the total current draw for all connected devices is limited to 33 mA (during normal standby conditions) using a 1.2 AH battery.

California State Fire Marshall Listed Installations

Applied for.

Note
Before beginning installation, installers must verify compatibility with the following central station receivers.

Planning the Installation

This section describes system capabilities to help you get familiar with the system. “Appendix B” provides planning sheets with tables that let you record the hardware and programming configuration of the system. Fill in all necessary information ahead of time to help prepare for system installation.

Standard Panel

The following describes the basic panel (out-of-box) hardware capabilities.

- **Power:** Input for an AC step-down, plug-in style transformer.
- **2 Siren Outputs/Zone Inputs:** Terminals for connecting hardwire sirens or normally closed (NC) loop switch circuits.
- **Phone Line Connection:** Allows panel to communicate with central monitoring station, voice event notification and/or pagers.

System Overview

This section gives an overview of the components that make up the system (control panel and system devices). Before installation, plan your system layout and programming using the worksheets in “Appendix B.”

System Components

The security system has three types of components: the control panel, devices that report to the panel and devices that respond to commands from the panel (see Figure 1).

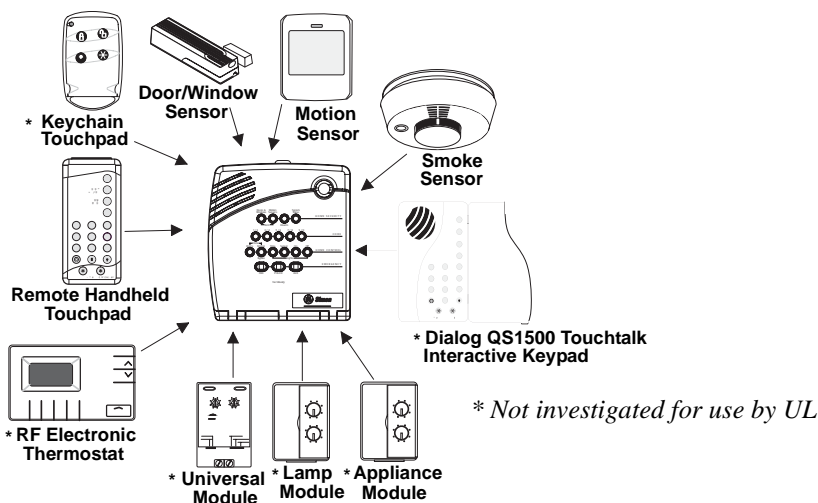

Figure 1. Typical Security System Components

Control Panel

The control panel is the main processing unit for all system functions. It receives and responds to signals from wireless sensors and wireless touchpads throughout the premises. For monitored systems, the panel can be connected to the premises phone line for central monitoring station, pager and/or voice event notification reporting.

Two panel models are available. One has an on-board 2-way voice microphone, the other does not. The Interrogator[®] 200 Audio Verification Module can be added to either panel.

An optional Braille Kit (60-915) is available for visually impaired users.

Note

ToolBox has not been investigated by UL and should not be used to program panels in UL listed systems.

User Interface

When the panel cover is closed, the panel buttons *operate* the security system. The user operates the panel by pressing panel buttons or by using a touchpad. See the User Manual for complete operation instructions.

When the panel cover is open, the buttons *program* the security system. The panel can be programmed on-site by the installer or user, or from off-site using ToolBox[®] software. See the “Programming” section of this manual for complete on-site programming instructions. See the ToolBox manual and ToolBox on-line help for off-site programming instructions.

Panel Tamper

If the panel cover is opened while the system is armed, an intrusion alarm occurs. When the system status button is subsequently pressed, the panel says *System Access Alarm*.

System Devices

The system can monitor up to 24 sensors and may use any of the following:

Door/Window Sensor (60-670)

For intrusion protection, install Door/Window sensors on all ground-floor doors and windows. At a minimum, install them in the following locations:

- All easily accessible exterior doors and windows.
- Interior doors leading into the garage.
- Doors to areas containing valuables such as cabinets and closets.

Indoor Motion Sensor (60-639)

Indoor motion sensors are ideal whenever it is not practical to install door/window sensors on every opening. Identify areas where an intruder is likely to walk through. Large areas in an open floor plan, downstairs family rooms, and hallways are typical locations for indoor motion sensors. For installations with pets, use the SAW Pet Immune PIR (60-807).

Outdoor Motion Sensor (60-639)

Use outdoor motion sensors to detect motion in a protected outdoor area. Detected motion in this protected area can sound chimes or turn on outside lights. **Do not use Outdoor Motion Sensors for intrusion protection.**

Freeze Sensor* (60-742)

Freeze sensors detect low temperature conditions which may indicate a furnace failure. The sensor contains a bimetallic thermal switch connected to the built-in transmitter. The sensor transmits an alarm signal to the panel when the surrounding temperature drops to about 41°F (5°C). When the temperature rises to 50°F (10°C), the sensor transmits a restore signal.

Water Sensor* (60-744)

Water sensors detect a water leak/rising water. The detector is connected to the sensor by an 8-foot (2.4-meter) cable. Water that reaches both detector contact points activates the sensor, causing it to transmit an alarm signal.

Smoke Sensor (60-848-95)

Smoke sensors provide fire protection by causing an alarm to sound throughout the house. You can add smoke sensors near sleeping areas and on every floor of the house. Avoid areas that could have some smoke or exhaust such as attics, kitchens, above fireplaces, dusty locations, garages, and areas with temperature extremes. In these areas you may want to install Rate-of-Rise sensors to detect extreme temperature changes. See “Emergency Planning” and the instructions packaged with the smoke sensor for complete placement information.

Carbon Monoxide (CO) Alarm* (60-652-95)

The Learn Mode™ CO Alarm alerts users to hazardous levels of carbon monoxide gas. If dangerous concentrations of gas are present, the red indicator light comes on, the internal siren goes off, and an alarm is transmitted to the panel. The panel sounds its own alarm and reports to the central station.

Keychain Touchpad* (60-659)

The Keychain Touchpad lets you turn the system on and off from right outside the home or activate a panic alarm if there is an emergency. If you have X10 Lamp Modules, you can use keychain touchpads to turn all system controlled lights on and off.

ELM (Encrypted Learn Mode) Keychain Touchpad (60-832)

The ELM (Encrypted Learn Mode™) 2-Button Keychain Touchpad is an alkaline battery-powered, wireless touchpad that allows users to arm and disarm their system, and activate a police or auxiliary panic alarm. Random encrypted signal transmissions provide high security to help prevent signal copying.

Remote Handheld Touchpad (60-671)

The Remote Handheld Touchpad lets you turn the system on and off while in the home, turn system controlled lights on and off (all or individual lights), or activate a panic alarm if there is a non-medical emergency.

Dialog QS1500 Touchtalk Interactive Keypad* (60-924-01-3)

The wall-mounted wireless Dialog QS1500 Touchtalk Interactive Keypad combines a conventional Learn Mode™ touchpad with an RF receiver, speech chip, and voice amplification circuit.

Dialog RF Electronic Thermostat* (60-909-95)

The Dialog RF Electronic Thermostat provides a money saving and convenient way to monitor and control temperatures. The thermostat uses low and high temperature limits to save energy. Temperature limits set on the thermostat determine when the heat or air conditioning turns on. There can be only one RF Thermostat per system.

Water Resistant Personal Help Button* (60-906-95)

The Water Resistant Personal Help Button is a wireless device used for activating police, medical or auxiliary alarms through your system. When the help button is pressed, the light mounted under the cover will blink and an alarm signal is transmitted.

X10 Modules*

When the panel is powered using the line carrier power transformer, the system can work with any of the following modules:

- X10 Lamp Module (13-403)
- X10 Appliance Module (13-402)
- X10 Powerhorn/Remote Siren Module (13-398)
- X10 Universal Module (13-399)

Interrogator 200 Audio Verification Module* (60-787)

The Audio Verification Module (AVM) gives the central station operator the ability to hear what's happening at the premises during an alarm and to speak directly to the system user. The operator can then determine how serious an alarm is, find out what kind of help is needed, and dispatch the appropriate assistance. Only one AVM may be installed per panel.

Ethernet Interface Module (60-938)

The Ethernet Interface Module is designed to provide an additional reporting method for Simon panels. The module reports events to the premisesconnect.com web site and up to two Osborne Hoffman (OH2000E) network receivers.

Preemisesconnect.com is used by:

- Installers - to aid in installation and maintenance of security systems.

Note

The ELM Keychain Touchpad is only compatible with Simon® 3 panels version 3.3 and later.

Note

Use of X10 modules has not been investigated by UL.

- Dealers - to simplify customer and account management.
- First Responders - to identify where and how to respond.
- Customers - to receive event notifications and to control their security system.

Dialog™ Telephone Interface Module (DTIM) (60-879-95R)

Note
 The DTIM doesn't support AVM, remote access or any call back from the central station. It is for reporting purposes only.

The DTIM is a battery operated communication link between the security system control panel and the central monitoring station. The DTIM receives radio signals from the panel, then uses the phone line to report security system events to the central station.

* Not investigated for use by UL.

Planning Sensor Types & Locations

The first step to an easy and successful installation is to decide what areas or items to protect, which lights or appliances to operate, and the best location for the panel, touchpad, sensors, and sirens.

Metal objects, mirrors, and metallic wallpaper can block signals sent by the wireless sensors. Make sure there are no metal objects in the way when installing the system.

Use the planning tables in “Appendix B” to determine the appropriate Sensor Type for the sensors you will be adding. You’ll need to understand the application for each sensor. For example, Keychain Touchpads are typically programmed as sensor group 01 (Portable panic), used to send an intrusion alarm to a central monitoring station. This sensor type is instant intrusion, it does not require restoral or supervisory communication with the panel and it is active in 4 arming levels (disarm, arm doors & windows, arm motion sensors, and arm doors/windows and motions sensors).

Recommended Sensor Groups

Device	Recommended Sensor Group
Keychain Touchpad	01, 03, 06, 07
ELM Keychain Touchpad	01, 03, 06, 07
Remote Handheld Touchpad	01, 03, 06, 07
QS1500 Keypad	01, 03, 06, 07
Indoor Motion Sensor	17 (intrusion), 25 (chime)
Outdoor Motion Sensor	25
Smoke Sensor	26
Exterior Door	10
Interior Door	14
Window Sensor	13
CO Alarm	34
Freeze Sensor	29
Water Sensor	38
RF Electronic Thermostat	36
Personal Help Button	01, 03
DTIM	08, 36

Device Locations

Control Panel

Locate the panel where alarm sounds can be heard and is easily accessible for operation.

Do not install the panel near a window or door where it can be reached easily by an intruder.

Remote Handheld Touchpad

Locate Remote Handheld Touchpads where they will be convenient and offer quick access to the user.

QS1500 Keypad

Locate QS1500 Keypads where they will be convenient and offer quick access to the user. When mounted, they must be within 600 feet (183 meters) of the control panel.

Keychain Touchpad

Keychain Touchpads attach to the owner's key ring or can be conveniently carried.

Dialog Telephone Interface Module

Mount the DTIM within 100 feet (30 meters) of the panel, but no closer than 10 feet (3 meters) to another DTIM or the panel.

X10 Modules

The system can control up to 8 individual unit numbers on Lamp, Wall switch, Appliance, and Universal Modules.

House Code and Unit Numbers

Each device (lamp, appliance, etc.) controlled by the panel must have an identification setting. The modules use two dials to set identification codes: one with letters A through P and one with numbers 1 through 16.

The lettered dial sets the house code, which enables the system to differentiate this home from other homes in the area. Set all modules (except the remote siren) and the panel to the same house code.

The numbered dial sets the unit number, which identifies and lets you control a specific device. Each device must have a unique unit number (1-8) to be individually controlled. For example, lights and appliances operated from a Remote Handheld Touchpad or operated by a sensor; or lights programmed to go on during the entry/exit delay or at scheduled times.

Note

All Lamp Modules with the same house code will turn on or flash as a group during an alarm or when operating the "Light" button on a Keychain Touchpad.

Note

When unit numbers 9-16 are used for lamp modules, they can only be controlled by an all on or all off command. A lamp will flash to the arming level if its unit number is set to 10. A lamp set to unit number 10 will flash once if the panel is disarmed, twice if doors & windows are armed, etc. The remote siren can be set to any unit number to hear alarm sounds. Set it to unit number 9 to also hear arming level beeps, status beeps, and trouble beeps. Do not use a lamp module to control appliances. Use an appliance module, since the wattage rating on Lamp Modules is less than on Appliance Modules.

Manually Controlling Lights

Lights with even unit numbers (2, 4, 6, 8) can be controlled from either the panel, Remote Handheld Touchpad or QS1500 Keypad. Lights with odd unit numbers (1, 3, 5, 7) can only be controlled from a Remote Handheld Touchpad or QS1500 Keypad.

➤ To Fill Out the Home Control Planning Table:

1. Set the house code on all modules (except the remote siren) to the same letter.
2. Set the Remote Siren house code to the *next* alphabetical letter. For example, if you chose house code B in step 1 above, set the remote siren house code to C.
3. Set the module unit numbers.
4. List the location of the lamp or appliance in the Location column of the Home Control Planning Table.
5. Write the location of each Lamp Module on an adhesive note and label the module.
6. Decide if the device should be activated by sensors, entry/exit delay, time, or a combination. An example of sensor activation is using a motion sensor to turn on a light. Record the information in the appropriate columns.

Note

The house code instructions that come with the Power-horn Siren won't work with this panel. Follow the house-code instructions given here.

Note

If you are using a Universal Module to operate a device, make sure to assign a unique unit number to this module, choosing from 1-8.

Use the following tables to help you further plan X10 module installation.

X10 House Code Assignments

X10 Device	Settings
Lamp, Appliance, Universal	Set all modules to the same house code (A - O) except the remote sirens.
Remote Siren	House code must be set to the next higher alphabetical letter.

X10 Unit Number Assignments

Unit #	Result
1 - 8	<ul style="list-style-type: none"> Used for sensor-activated, time-activated, and entry/exit delay lights. Sensor activated lights are enabled and disabled by pressing the LIGHTS Sensor Activated button on the panel. Time activated lights are enabled and disabled by pressing the LIGHTS Time Activated button on the panel. If using the universal module to operate a device, be sure to assign a unique unit number. The STAR button on the KeyChain Touchpad activates the universal module controlled device or to turn on special lights if programmed.
9	<ul style="list-style-type: none"> Used for remote siren or light control. For remote siren use, sirens with this setting sound alarms, arming level beeps, status beeps, and trouble beeps. For light control, lamp modules with this setting are controlled by an all on or all off command.
10	<ul style="list-style-type: none"> Used for remote siren or light control. For remote siren use, sirens with this setting only sound alarms. For light control, lamps will flash according to selected arming level and are controlled by an all on or all off command.
11 - 16	<ul style="list-style-type: none"> Used for lamp modules and controlled by an all on or all off command.

Installing the System

This section describes how to open the panel for mounting, mount the panel, connect sirens, hardwire contacts, and the AC power transformer.

Materials Needed

- Pencil
- Phillips Screwdriver

Opening the Panel Cover and Chassis

Tabs at the top of the panel secure and release the front cover and the chassis. The plastic hinges on the panel bottom allow the cover and chassis to swing down and out of the way (see Figure 2).

Note

If Option 40 Trouble Beeps is on, the panel will sound six trouble beeps every minute the panel cover is open.

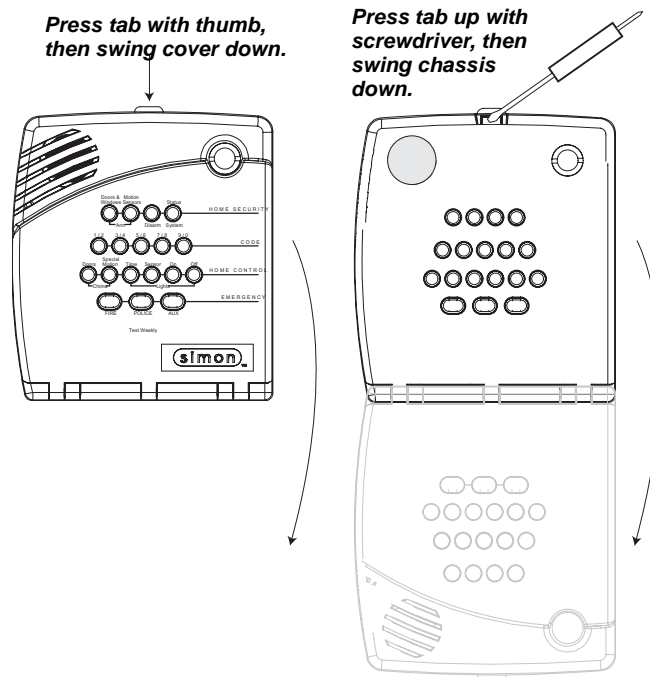

Figure 2. Opening the Panel Cover and Chassis

Mounting the Panel

The panel must be securely mounted on a wall or on the optional Tabletop Base.

Wall Mounted Panel

The panel must be securely mounted to the wall using the 4 screws supplied to prevent accidental movement and to protect the consumer from the system wiring and terminals.

1. Choose a panel location.
2. Run all necessary power, phone, siren, and hardwire contact wires to the desired panel location.
3. Refer to Figure 3 (Wall Mount) for mounting hole locations.
4. Hold the panel against the wall and mark the mounting hole locations with a pencil.
5. Insert wall anchors into holes where studs are not present.
6. Install all screws and tighten gently.

Tabletop Mounted Panel

The tabletop base must be fitted to the back of the panel if the panel is to be used on a table or bench.

1. Select a suitable location near power and phone line.
2. Run all necessary wires from the panel through the openings in the tabletop base.
3. Refer to Figure 3 (Tabletop Mount) for mounting hole locations.
4. Place the panel back on the tabletop base until the top and bottom panel mounting holes line up with the mounting holes on the tabletop base.
5. Secure the panel to the tabletop base with the screws provided.
6. Ensure the cables are neat and will not create a tripping hazard.

Note

When choosing the AC outlet location for the AC power transformer, make sure the outlet is not controlled by a switch or that it is not part of a ground fault interrupt circuit (GFI).

Note

A tabletop mounted application is only recommended when the panel requires the power and telephone cable as the only hardwire connections. Use the wall mounted position in all other applications.

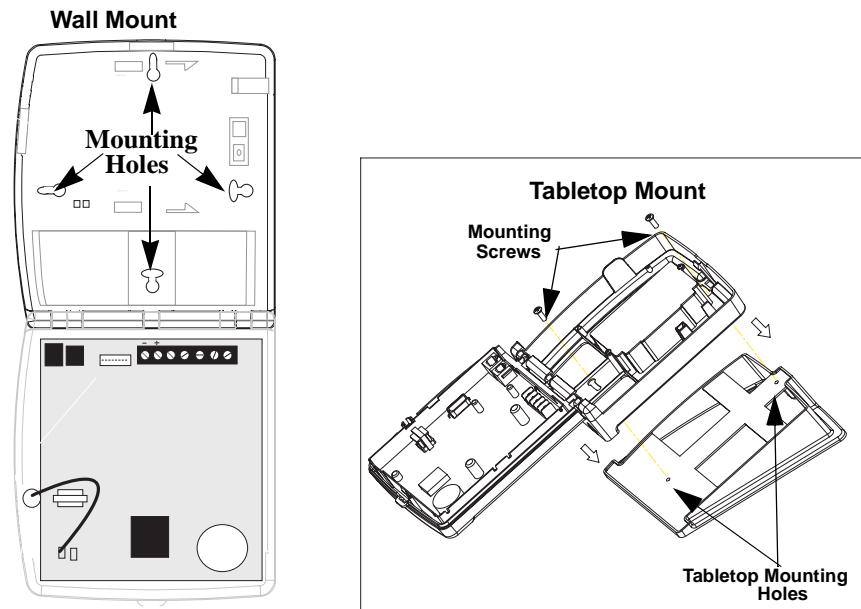

Figure 3. Panel Mounting Hole Locations

Connecting Hardwire Devices

The panel has 5 screw terminals located on the upper-right corner of the circuit board (see Figure 3) for connecting AC power, sirens and/or hardwire detectors.

AC Terminals

These terminals are used for connecting a Class II 9 VAC, 700 mA AC power transformer. For systems with no X10 modules, use transformer part no. 22-109-ITI. For systems with X10 modules, use transformer part no. 22-129-ITI.

Note

All inputs and outputs are Class II power limited circuits.

HWIN1, HWIN2, and DCOUT Terminals

These terminals are dual purpose and can be used for either siren or hardwire detector connections. Options 96 and 97 control how the output on HWIN1 and HWIN2 will function.

Sirens

From the factory, these terminals are set up for siren operation with HWIN1 handling interior sirens (status and alarm sounds), HWIN2 handling exterior sirens (alarm sounds only), and DCOUT providing the positive (+) voltage.

With Option 53: Hardwire Siren Supervision turned on, sirens connected to HWIN1 and HWIN2 are supervised and require a 4.7k resistor in the circuit. If either of these terminals is not used with Option 53 on, you must connect a 4.7k resistor between the unused terminal and DCOUT.

Note

The total current available from the DCOUT terminal is 250 mA (50 mA with the Ethernet Interface Module installed) at up to 122° F (50° C).

Hardwire Detectors

To set up HWIN1 and/or HWIN2 for hardwire detectors, make the required connections as described under “Wiring Hardwire Contacts,” then proceed to the “Programming” section to add (learn) them into panel memory.

Wiring Interior Sirens

Panel terminal HWIN1 can be used for connecting interior sirens and activates for status and alarm sounds.

For circuit supervision, which allows the panel to detect if the siren wire is cut (open), Option 53: Hardwire Siren Supervision must be turned on (see the “Programming” section) and interior sirens must be wired with a resistor in the circuit.

LD105 Hardwire Interior Siren

Connect the LD105 Hardwire Interior Siren (13-374) to the panel using a 4.7k resistor (included with siren) as shown in Figure 4. The resistor must be connected across the siren wires as close to the siren as possible.

Note

Do not install the resistor at the panel terminals. This does not provide supervision of the wire.

Note

If you are installing only an interior siren and no exterior siren and Option 53 is on, you must connect a 4.7k resistor between the HWIN2 and DCOUT terminals in addition to the resistor between HWIN1 and DCOUT shown in Figure 4.

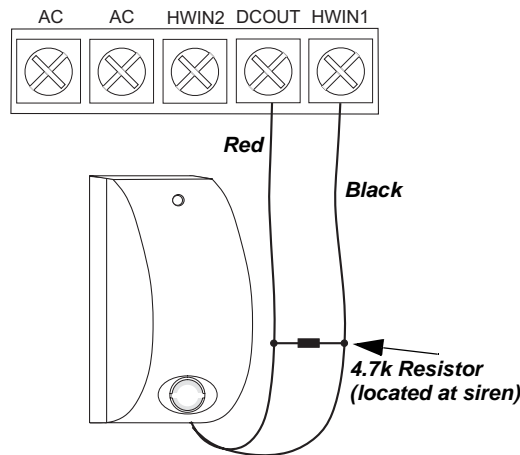

Figure 4. Hardwire Interior Siren with Supervision

Wiring Exterior Sirens

Panel terminal HWIN2 can be used for connecting exterior sirens and activates when intrusion and fire alarms occur.

Exterior sirens can be wired with or without a resistor in the circuit for supervision. For circuit supervision which allows the panel to detect if the siren wire is cut (open), Option 53: Hardwire Siren Supervision must be turned on (see the “Programming” section).

Hardwire Exterior Siren with Supervision

Connect the Hardwire Exterior Siren (13-046) to the panel using a 4.7k resistor (included with siren) as shown in Figure 5. The resistor must be connected across the siren wires as close to the siren as possible.

Note

Do not install the resistor at the panel terminals. This does not provide supervision of the wire.

Note

If you are installing only an exterior siren and no interior siren and Option 53 is on, you must connect a 4.7k resistor between the HWIN1 and DCOUT terminals in addition to the resistor between HWIN2 and DCOUT shown in Figure 5.

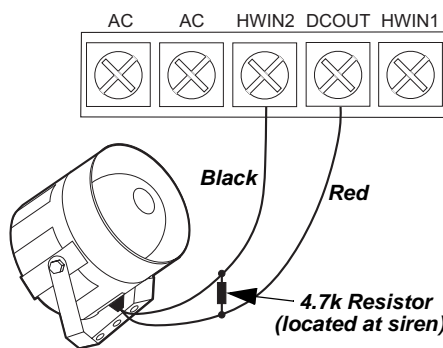

Figure 5. Hardwire Exterior Siren with Supervision

Hardwire Exterior Siren without Supervision

With Option 53 turned off, connect the Hardwire Exterior Siren (13-046) to the panel without a resistor as shown in Figure 6

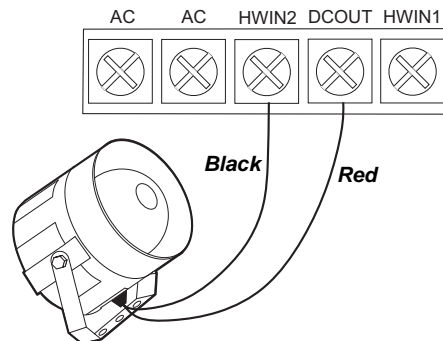

Figure 6. Hardwire Exterior Siren without Supervision

Wiring Hardwire Contacts

You can connect hardwire reed switches (normally closed loop only) to HWIN1 and/or HWIN2, if either terminal is not being utilized for a hardwire siren.

Important !

Connect only normally closed (N/C) reed switches to HWIN1 and/or HWIN2. Other types of hardwire detectors should not be used.

Note

Do not install the resistor at the panel terminals. This does not provide supervision of the wire.

The total resistance of the wire loop must not exceed 3 ohms. This allows you to use up to 200 feet (61 meters) of 2-conductor, 22-gauge stranded wire.

Connect hardwire reed switches to the panel using a 47k resistor as shown in Figure 7. The resistor must be connected at the last switch in the circuit.

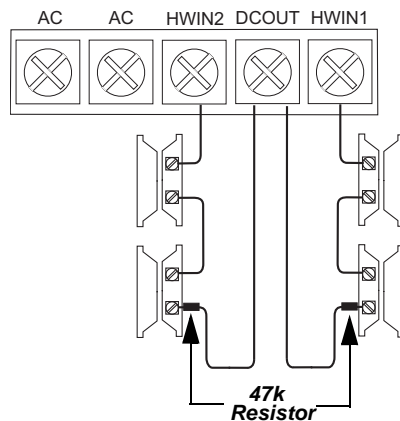

Figure 7. Connecting Normally Closed Hardwire Reed Switches

Wiring a Phone Line to the Panel

You can connect a phone line to the panel for systems monitored by a central monitoring station and/or systems that notify users by a digital pager or voice event notification.

Basically, there are two methods for connecting the panel to a phone line; full line seizure and no line seizure.

Full Line Seizure

This method requires that the panel be wired ahead (or in front) of all other phones, answering machines, computers, or other devices on the phone line. This allows the panel to take over (seize) the phone line, even if another device on the line is in use.

An RJ-31X (CA-38A) jack should be installed when wiring for full line seizure. This lets the user quickly and easily disconnect the panel from the phone line in case the panel disables the phone line due to a malfunction.

Full Line Seizure Wiring with an RJ-31X

1. Run a 4-conductor cable from the TELCO block to the RJ-31X (A in Figure 8).
2. Connect the 4-conductor cable wires to the RJ-31X (B in Figure 8).
3. Disconnect the Green and Red premises phone jack wires from the TELCO block and splice them to the 4-conductor cable Black and White (or Yellow) wires (C in Figure 8). Use weatherproof wire connectors for these splices.
4. Connect the 4-conductor cable Green and Red wires to the TELCO block TIP (+) and Red to RING (-) posts (D in Figure 8).
5. Connect the phone cord included with the panel to the RJ-31X and the panel LINE IN jack (E in Figure 8)

Note

For UL Listed systems, the RJ-31X jack must be mounted within 5 feet (1.5 meters) of the panel.

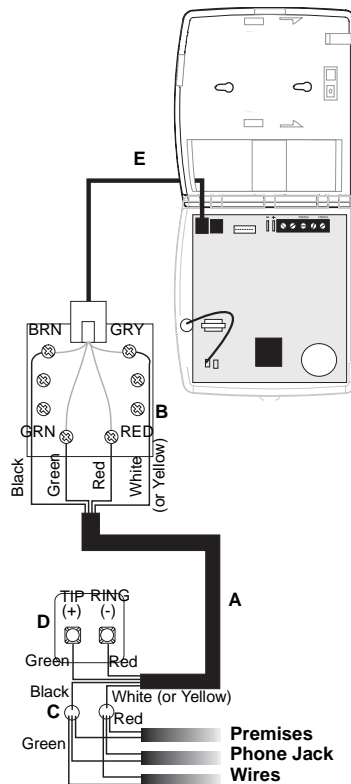

Figure 8. Full Line Seizure Wiring with an RJ-31X

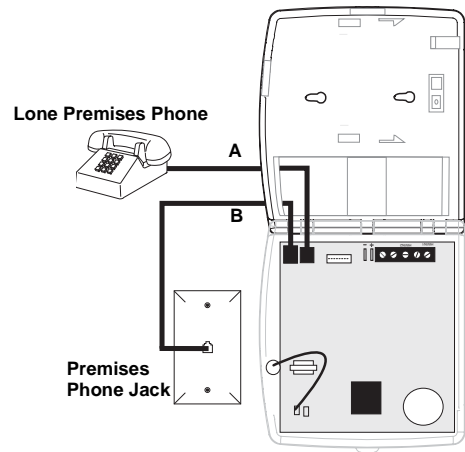

Figure 9. Full Line Seizure Wiring with 1 Premises Phone

Full Line Seizure Wiring with 1 Premises Phone

If a single phone is all that exists on the premises, full line seizure can be accomplished without an RJ-31X.

1. Disconnect the phone from the premises phone jack and plug it into the panel PHONE jack (A in Figure 9). This jack is disconnected automatically whenever the panel reports.
2. Connect the phone cord included with the panel to the panel LINE IN jack and the premises phone jack (B in Figure 9).

Note

If the customer ever adds a phone or other phone device to another phone jack, full line seizure no longer exists. Inform the customer to contact you if they want to add a phone or other device so that you can rewire for full line seizure by adding an RJ-31X.

Note

Connecting the panel to a standard phone (voice) line in this manner should be avoided. Other devices in use at the same time the panel is using the line can prevent reports from going through.

No Line Seizure

This method is typically used where DSL (digital subscriber line) service exists. DSL allows multiple devices on a single phone line to be used simultaneously. Simply connecting the panel LINE IN jack to an available phone jack on the premises is all that is required.

An in-line filter may be required to ensure panel reporting is successful.

* For UL installations, installer needs to verify line seizure.

Wiring the Power Transformer

Connect the power transformer to the panel AC terminals as shown in Figure 10.

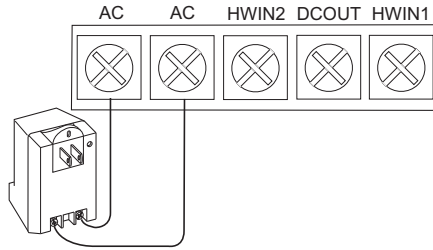

Figure 10. Connecting the Power Transformer

Note

Do not plug in the transformer at this time

Powering Up the Panel

When applying power to the panel connect the battery first, then plug in the AC power transformer. This sequence prevents a battery fault condition.

Installing the Panel Backup Battery

1. Remove the cover from the Battery Compartment (A in Figure 11).
2. Connect the red and black battery leads (included with panel) to the battery and panel terminals (see B in Figure 11).
3. Place the battery in the compartment, running the wires through the openings in the top and bottom of the compartment.

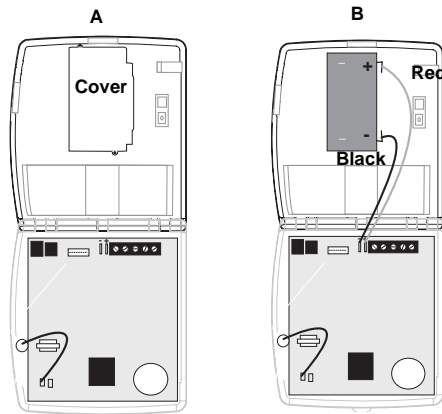

Figure 11. Installing the Panel Backup Battery

4. Replace the cover to the Battery Compartment (see Figure 12).



Caution

Tighten the screws to the Battery Compartment securely. Failure to do so could result in damage to the panel board when the cover and chassis are closed.

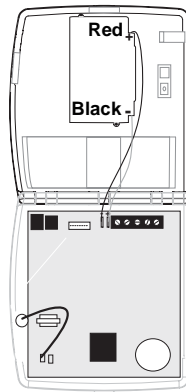

Figure 12. Battery Connected in Compartment

Note

Make sure the outlet is not controlled by a switch or that it is not part of a ground fault interrupt circuit (GFIC).

Applying AC Power

1. Remove the center screw from the outlet cover plate and hold the cover plate in place.



Warning

Use extreme caution when securing the transformer to a metal outlet cover. You could receive a serious shock if a metal outlet cover drops down onto the prongs of the plug while you are securing the transformer and outlet cover to the outlet box.

2. Plug the transformer into the lower receptacle of the outlet so that the hole in the transformer tab lines up with the outlet cover screw hole. The panel voice should announce "Hello, system XX is OK"
3. Insert the cover plate screw through the transformer tab and the outlet cover plate. Tighten the screw firmly.

Installing X10 Modules

Lamp and Appliance Modules

1. Set the unit code dial to a unit number different from all other X10 modules (between 1 and 8).
2. Set the house code for the installation.
3. Plug the module into a wall outlet.
4. Plug the lamp/appliance into the module.



Caution

Do not plug in appliances or lamps with 300-watt or larger bulbs into Lamp Modules

Note

See "Light and Appliance Controls" to program a Key-chain Touchpad to activate a Universal Module controlled device.

Universal Module

1. Set the unit code dial to a unit number different from all other X10 modules (between 1 and 8).
2. Set the house code for the installation.
3. Set the module switches to momentary and relay only.
4. Connect the module terminals to the desired device terminals.
5. Plug the universal module into a wall outlet.

Sensor Installation

Program sensors and devices before you install them. Use the following section to program the panel and add the sensors to panel memory.

Programming

Entering Program Mode

There are 2 codes you can use to enter program mode.

Utility Access Code 1 (Dealer Code)

Depending upon how Option 54 is set, the default utility access code is 654321, 54321, 4321 (factory default), or 321. This code can be used for all programming.

Utility Access Code 2 (Installer Code)

Depending upon how Option 54 is set, the default access code is 654321, 54321, 4321 (factory default), or 321. This code is limited to changing all but the following: Utility Access Code 1, Options 4, 5, 6, 8, 9, 12, 13, 54, and 69.

1. Open the panel cover.
2. Enter Utility Access Code 1 or 2 using the numbered keys.

The panel is now in program mode. Follow the programming arrows on the panel label. The system prompts you through programming steps with beeps and voice messages.

➤ Program the panel in this order:

1. Set the panel clock.
2. Add (learn) sensors.
3. Set House Code and Light & Appliance Controls (Entry/Exit activated lights, Sensor activated lights, Time activated lights).
4. Change numbered Options as needed.

Exiting Program Mode

Close the cover to exit program mode when you are finished programming.



Do not power down the panel while in program mode or all programming will be lost. The panel stores programmed information only when you exit program mode (close the cover and leave closed for at least 5 seconds).

Caution

Reset Memory to the Factory Defaults

1. Open the panel cover and enter Utility Access code 1.
2. Unplug the transformer and disconnect the battery.
3. Simultaneously press and hold **Cancel**, **Clock Set**, and **Minutes +**.
4. Restore power to the panel with the battery while pressing these three buttons. The panel announces "Hello. System XX OK." Release the buttons.
5. Plug in the transformer to the outlet.

Set the Clock

1. Press **Clock Set** from the Start Menu.
2. Press the **Hours +** and **-** keys and listen to the voice prompts. Stop when panel voice announces the correct hour.
3. Press the **Minutes +** and **-** keys and listen to the voice prompts. Stop when the panel announces the correct minutes.
4. Press **Done**. The panel announces the set time.

Note

Do not remove panel power while in program mode. Programming changes are saved only when exiting program mode (closing the panel cover).

Note

If Option 8: Phone Lock is on, options 04, 05, 06, 07, 08, 09, 12, 13, 54, 56 and Dealer Code will not reset to their defaults.

Adding (Learning) Sensors

These instructions describe how to add sensors, touchpads and other system devices into panel memory. The panel recognizes a sensor when you press a sensor program button, press and release a tamper switch, press a sensor test button, or put a sensor into alarm.

Note

The hardwire inputs must have sirens or hardwire sensors with 47k Ohm resistors connected between the DCOUT and HWIN1 or HWIN2 terminals before learning in a sensor. If one of these connections is not made, the panel will learn in a hardwire zone.

Note

If you are installing a sensor on a gun case, jewelry box, or similar usage, and the sensor is active in level one, you must sub-disarm to avoid putting the panel into alarm when the sensor and the magnet are separated.

The following table, “Device Programming,” describes the programming button location for each device.

Device Programming

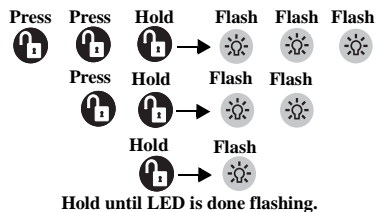
Device	To Program
Door/Window Sensor	Press button on top of sensor (cover removed) or trip tamper
Motion Sensor	Press button on back of sensor (mounting plate removed) or trip tamper
Smoke Sensor	Trip tamper, press test button, remove from base or put sensor in alarm
Keychain Touchpad	Press and hold Lock & Unlock buttons together
ELM Keychain Touchpad	 <p>Hold until LED is done flashing.</p>
Remote Handheld Touchpad	Press the EMERGENCY buttons
QS1500 Keypad	Press Lights Off button 6 times
Hardwire Sensors	Separate sensor from magnet
CO Alarm	Plug in the module wait 5-7 seconds press and hold the test button for 9 beeps
Freeze & Water	Trip tamper or press and hold button on top of the sensor (cover removed) until control panel confirms programming. If button is not held down long enough, SYSTEM STATUS reports sensor as open.
Dialog RF Electronic Thermostat	Unplug the thermostat from the base plate, wait a few seconds, then plug the thermostat back into the base plate.
Personal Help Button	Press the help button until the light blinks.

Device Programming

Device	To Program
DTIM Note <i>When changes are made to panel programming options that affect DTIM (i.e. phone numbers), the DTIM is not updated until panel programming mode is exited. After a few minutes, the DTIM should be updated.</i>	Press and release the DTIM tamper switch as follows: <ol style="list-style-type: none"> 1. Press 3 times, holding the tamper switch down on the third press until the LED flashes 3 times. Release after third flash. 2. Immediately press 2 times, holding the tamper switch down on the second press until the LED flashes 2 times. Release after second flash. 3. Immediately press and hold, then wait for the panel to beep once indicating it learned the DTIM. Release the tamper switch.

When adding (learning) sensors, the panel uses an ascending numbering sequence starting with 1. You can override this by entering a 2 digit sensor number using the numbered keys immediately after entering the sensor group.

Use the Table in Appendix B, which was filled out during the system planning, to help program sensors.

Note

*For a more specific location name, press **Option #** for compass directions (north, northeast, east, southeast, south, southwest, west, northwest).*

➤ **To add a hardware or RF sensor or remote control:**

1. Press **Add**. The panel announces “Select from Main Menu.”
2. Press **Sensor/Remote**. The panel announces “Press button on sensor.”
3. Press the sensor program button or release sensor tamper switch. The panel announces “Keychain Remote. Press sensor again for next name or press Done to select.”
4. Press **Sensor/Remote** repeatedly until you hear the name or item you want to use. An alphabetical list of names the panel uses appears in Appendix B. Each name may be used more than once.
5. Press **DONE** when you hear the desired name. The panel announces “Use numbered keys to enter sensor group.”
6. Enter the 2-digit sensor group. The panel announces the sensor group and the first available sensor number, then prompts you to press **DONE** to accept.
7. Press **DONE**. The panel confirms programming by announcing the sensor number, name, and group.

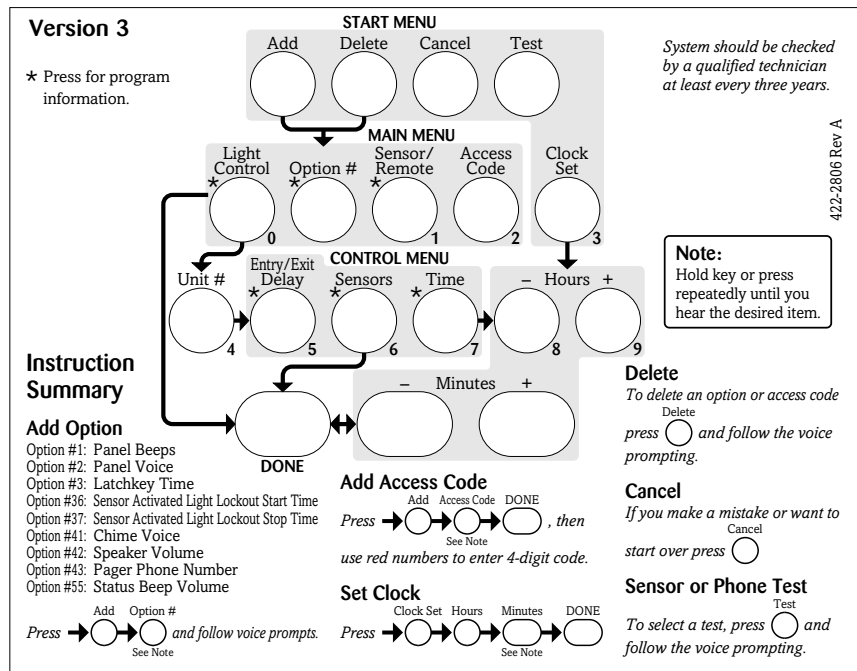

➤ **To delete sensors:**

1. Press **Delete**. The panel announces “Select from Main Menu.”
2. Press **Sensor/Remote** repeatedly until you hear the name and number you want deleted, then press **DONE**. The panel announces that the sensor is deleted.

X10 Module Operation

Use the following procedure to program X10 module operations into panel memory. Notice that the **Light Control** button is used to program **all** X10 module operations (light, appliance, and universal).

➤ **To program the house code:**

1. Press **Add**.
2. Press **Light Control** repeatedly until you hear the desired house code letter.
3. Press **DONE**.
4. Set the HOUSE dial on each lamp, appliance, and universal module, to the same letter.
5. Set the HOUSE dial on powerhorn/remote sirens to the next sequential alphabetical letter.

➤ **To add an entry/exit activated module:**

1. Press **ADD**.
2. Press **Light Control**.
3. Press **Unit #** repeatedly until you hear the unit number that matches the one you chose for the module.
4. Press **Entry/Exit Delay**. The panel confirms your programming.

➤ **To add a sensor-activated module:**

1. Press **ADD**.
2. Press **Light Control**.
3. Press **Unit #** repeatedly until you hear the unit number that matches the one you chose for the module.
4. Press **Sensors** until you hear the sensor you want to control the light.

Note
A Keychain Touchpad button can also be programmed to control a light or appliance module.

5. Press **DONE**. The panel confirms your programming.
- **To add a time-activated module:**
 1. Press **Add**.
 2. Press **Light Control**.
 3. Press **Unit #** until you hear the unit number that matches the one you chose on the module.
 4. Press **Time**.
 5. Press **Hours** and **Minutes** to set the beginning of the schedule.
 6. Press **DONE**.
 7. Press **Hours** and **Minutes** to set the end of the schedule.
 8. Press **DONE**. The panel confirms your programming.
- **To delete an Entry/Exit-activated module:**
 1. Press **Delete**.
 2. Press **Light Control**.
 3. Press **Unit #** repeatedly until you hear the unit number you want deleted.
 4. Press **Entry/Exit Delay**, then press **DONE**. The panel confirms your programming.
- **To delete a sensor-activated module:**
 1. Press **Delete**.
 2. Press **Light Control**.
 3. Press **Unit #** repeatedly until you hear the unit number you want deleted.
 4. Press **Sensors** until you hear the one you want deleted.
 5. Press **DONE**. The panel confirms your programming.
- **To delete a time-activated module:**
 1. Press **Delete**.
 2. Press **Light Control**.
 3. Press **Unit #** repeatedly until you hear the unit number you want deleted.
 4. Press **Time**.
 5. Press **DONE**. The panel confirms your programming.

Ethernet Interface Module

Requirements

- Broadband Internet connection (DSL or cable modem)
- An available 10-Base-T or 10/100-Base-T Ethernet Port

Note

Devices between the Ethernet Interface module and the transmission line (hub, router, cable modem, etc. must be UL listed and must not receive power from a switched outlet.



Caution

If connecting devices ("hub", router, cable modem) do not have battery backup, the system will lose communication with the reporting station if AC power is lost.

Activate the Ethernet Interface Module

In order to program the module through the Simon panel you must activate the connection between the panel and module. Activating the communication channel and gaining access to the module's Remote Options is accomplished by turning Option 89 On. Follow the instructions below to activate the module.

- **To activate the Ethernet Interface module:**
 1. Enter Utility Access Code 1 (Dealer Code) if you are not already in program mode.
 2. Press **Add**.

3. Press Option #.
4. Press 8, then 9.
5. Press Done. The panel announces “Option 89 is on.”
6. Verify both the red and green LEDs on the module and ethernet connector are blinking.

See Options 89-92 in this manual for custom programming options. See the *Ethernet Interface Installation Instructions (466-2161)* for more information on this module.

Numbered Options

Numbered options let you customize system operation according to dealer and user needs.

The “Option Settings” table in Appendix B lists all system options and their characteristics. Fill in the last column of the table before programming to help speed up the programming process.

There are two ways to reach the desired option setting.

- Press **Add** or **Delete**, then press **Option #** repeatedly until you hear the option you want changed.

Or—

- Press **Add** or **Delete**, **Option #**, then enter the option number using the numbered keys.

The following instructions use the last method.

Note

Although the panel voice prompts you through programming, it is not necessary to wait for the complete message before pressing the next button in the programming sequence.

Option 01: Panel Piezo Beeps	<i>(Default = on)</i>
<p>Determines whether the panel piezo produces beeps based on system activity (on) or is silent (off). The following table describes all possible beeps.</p> <p>Note <i>For all UL listed systems, Option 1 must be on (added).</i></p>	<p>➤ To turn on Panel Piezo Beeps, press:</p> <ol style="list-style-type: none"> 1. Add 2. Option # 3. 01 4. DONE <p>➤ To turn off Panel Piezo Beeps, press:</p> <ol style="list-style-type: none"> 1. Delete 2. Option # 3. 01 4. DONE

Panel Piezo Beeps

Activity	Piezo Beep Response
ARM Doors & Windows	<p>Exit Delay—2 beeps sound every 5 seconds and 2 times per second during the last 10 seconds.</p> <p>Silent Exit—2 beeps sound at the beginning of the exit delay and 2 more sound just before the exit delay expires.</p> <p>Entry Delay—2 beeps sound every 5 seconds and 2 times per second during the last 10 seconds.</p>

Panel Piezo Beeps

Activity	Piezo Beep Response
ARM Motion Sensors	Exit Delay—3 beeps sound every 5 seconds and 3 times per second during the last 10 seconds. Silent Exit—3 beeps sound at the beginning of the exit delay and 3 more sound just before the exit delay expires. Entry Delay—3 beeps sound every 5 seconds and 3 times per second during the last 10 seconds.
ARM Doors/Windows & Motion Sensors	Exit Delay—4 beeps sound every 5 seconds and 4 times per second during the last 10 seconds. Silent Exit—4 beeps sound at the beginning of the exit delay and 4 more sound just before the exit delay expires. Entry Delay—4 beeps sound every 5 seconds and 4 times per second during the last 10 seconds.
DISARM	1 beep
CHIME DOORS	2 beeps (when programmed)
CHIME SPECIAL MOTION	3 beeps (when programmed)
Trouble Beeps	6 beeps every minute. Press SYSTEM STATUS to stop beeps for 4 hours.
No Activity	20 beeps every minute for 5 minutes (when programmed)

Option 02: Panel Voice <i>(Default = on)</i>	
<p>Determines whether the panel announces all status, alarm, and program mode messages (on), or only announces messages for canceled alarms, open sensors (protesting), when SYSTEM STATUS is pressed, or if the panel is in program mode (off).</p>	<p>➤ To turn on Panel Voice, press:</p> <ol style="list-style-type: none"> 1. Add 2. Option # 3. 02 4. DONE <p>➤ To turn off Panel Voice Beeps, press:</p> <ol style="list-style-type: none"> 1. Delete 2. Option # 3. 02 4. DONE

Option 03: Latchkey*(Default = off)*

Determines whether the panel reports a Latchkey alarm if the system is not disarmed at a preset time between midnight and 11:59 P.M. (on). If the Latchkey feature is disabled (off), the panel will not report a Latchkey alarm.

Note

The system clock must be set for the Latchkey feature to work.

➤ To turn set Latchkey, press:

1. Add
2. Option #
3. 03
4. Press the Hours +/- buttons to select the correct hour.
5. Press the Minutes +/- buttons to select the correct minute.
6. DONE

➤ To turn off Latchkey, press:

1. Delete
2. Option #
3. 03
4. DONE

Option 04: Primary Phone Number*(Default = off)*

Lets you program up to a 26-digit central monitoring station receiver phone number for monitored systems (on), or delete an existing primary phone number (off).

- Press **Test** for each required pause
- Press **Add** for a *
- Press **Delete** for a #

Each pause, * and # uses one of the 26 available places.

Note

Pressing DONE is required if you enter fewer than 26 digits. The phone number is automatically stored without pressing DONE if all 26 places are used.

➤ To set Primary Phone Number, press:

1. Add
2. Option #
3. 04
4. Use the numbered keys to enter the phone number (up to 26 digits).
5. DONE

➤ To delete Primary Phone Number, press:

1. Delete
2. Option #
3. 04
4. DONE

Option 05: Secondary Phone Number*(Default = off)*

Lets you program up to a 26-digit central monitoring station receiver/numeric pager/voice event notification phone number for monitored systems (on), or delete an existing secondary phone number (off).

- Press **Test** for each required pause
- Press **Add** for a *
- Press **Delete** for a #

Each pause, * and # uses one of the 26 available places.

Note

For numeric pagers, add 2 pauses at the end of the number. Some pagers may require 3, 4 or more additional pauses to work correctly. Pagers that require the panel to dial more than 26 digits will not work. The panel calls a numeric pager twice for each report. Silent alarms report to a pager as an intrusion alarm. See the Table "Pager Reporting Messages" for more reporting information.

Pressing DONE is required if you enter fewer than 26 digits. The phone number is automatically stored without pressing DONE if all 26 places are used.

➤ **To set Secondary Phone Number, press:**

1. Add
2. Option #
3. 05
4. Use the numbered keys to enter the phone number (up to 26 digits).
5. DONE

➤ **To delete Secondary Phone Number, press:**

1. Delete
2. Option #
3. 05
4. DONE

Option 06: Downloader Phone Number*(Default = off)*

Lets you program up to a 26-digit phone number for a computer modem for using ToolBox Downloader (on), or delete an existing phone number (off).

Press Test for each required pause, Add for a *, and Delete for a # (each of which uses one of the 26 available places).

Note

Pressing DONE is required if you enter fewer than 26 digits. The phone number is automatically stored without pressing DONE if all 26 places are used.

➤ **To set Downloader Phone Number, press:**

1. Add
2. Option #
3. 06
4. Use the numbered keys to enter the phone number (up to 26 digits).
5. DONE

➤ **To delete Downloader Phone Number, press:**

1. Delete
2. Option #
3. 06
4. DONE

Option 07: Account Number*(Default = 00000)*

Lets you program up to a 10-character alphanumeric account number (on) or delete an existing account number (off).

To enter letters (A - F only), press 9 then the Minutes + button. The panel announces the letter A. Continue pressing the Minutes + button to progress through the alphabet.

Note

The CID format only supports account numbers with letters B through F, or numbers 0 through 9 (or a combination of those letters and numbers).

Pressing DONE is required if you enter fewer than 10 characters. The account number is automatically stored without pressing DONE if 11 characters are entered, of which only the first 10 are stored.

➤ **To set Account Number, press:**

1. Add
2. Option #
3. 07
4. Use the keys to enter the account number (up to 10 characters).
5. DONE

➤ **To delete Account Number, press:**

1. Delete
2. Option #
3. 07
4. DONE

Option 08: Phone Lock*(Default = off)*

Prevents resetting of phone/reporting related Options 04, 05, 06, 07, 08, 09, 12, 13, 54, 56 and Utility Code 1 when a memory clear is performed (on), or resets these options to their default values when a memory clear is performed (off).

➤ To turn on Phone Lock, press:

1. Add
2. Option #
3. 08
4. DONE

➤ To turn off Phone Lock, press:

1. Delete
2. Option #
3. 08
4. DONE

Option 09: Downloader Code*(Default = 12345)*

Lets you set a unique 5-digit code that is required for initiating ToolBox sessions (on) or sets the code to its default (off).

The code must be 5 digits long and can range from 00000 to 99999. The Downloader Code must match the downloader access code in the ToolBox account to perform ToolBox sessions.

Note

The downloader code should always be changed from the default setting to avoid competitor theft.

➤ To set Downloader Code, press:

1. Add
2. Option #
3. 09
4. Use the numbered keys to enter the downloader code (5 digits).
5. DONE

➤ To delete Downloader Code, press:

1. Delete
2. Option #
3. 09
4. DONE

Option 10: Entry Delay*(Default = 030 sec.)*

Determines how much time the user has to disarm the system after entering the armed premises through a designated delay door, before an alarm occurs. Beeps sound during the entire delay time to remind the user to disarm the system.

When turned on, the Entry Delay can be set from 005-254 seconds (030-254 if SIA Limits Option 69 is on). All entries must be 3 digits. When turned off, the Entry Delay is set to 005 seconds.

Note

For UL listed systems, the entry delay must not exceed 45 seconds.

➤ To set Entry Delay, press:

1. Add
2. Option #
3. 10
4. Use the numbered keys to enter the 3-digit delay time.
5. DONE

➤ To turn off Entry Delay, press:

1. Delete
2. Option #
3. 10
4. DONE

Option 11: Exit Delay*(Default = 060 sec.)*

Determines how much time the user has to leave the premises through a designated delay door after arming the system. Beeps sound after arming the system to remind the user to leave the armed premises.

If a delay door is opened after the Exit Delay expires, the Entry Delay begins. If the user arms the system with No Delay and opens a delay door after the Exit Delay expires, an alarm occurs.

When turned on, the Exit Delay can be set from 005-254 seconds (045-254 if SIA Limits Option 69 is on). All entries must be 3 digits. When turned off, the Exit Delay is set to 005 seconds.

Note

For UL listed systems, the exit delay must not exceed 60 seconds.

➤ **To set Exit Delay, press:**

1. Add
2. Option #
3. 11
4. Use the numbered keys to enter the 3-digit delay time.
5. DONE

➤ **To turn off Exit Delay, press:**

1. Delete
2. Option #
3. 11
4. DONE

Option 12: Phone 1 Reports*(Default = 00)*

Determines the primary phone number (Option 4) report content and reporting format. All entries must be 2 digits.

Note

UL has only verified reporting compatibility with the CS5000 Digital Alarm Communicator Receiver. For UL listed systems, Phone 1 Reports must be set to 0 or 1.

The Phone 1 & 2 Reports table below describes the choices.

Alarms include: Fire, Intrusion, Emergency, Silent, and Alarm Cancels.

Non-alarms include: Latchkey, No Activity, Openings, Closings, Fail to Open, Fail to Close, Force Armed, AC Power Failure, CPU Low Battery, and Trouble Restorals.

Note

This option must be turned off if using a DTIM to transmit on the regular phone line.

➤ **To set Phone 1 Reports, press:**

1. Add
2. Option #
3. 12
4. Use the numbered keys to enter 00 - 10 (see table below).
5. DONE

➤ **To turn off Phone 1 Reports, press:**

1. Delete
2. Option #
3. 12
4. DONE

Option 13: Phone 2 Reports*(Default = off)*

Determines the secondary phone number (Option 5) report content and reporting format. The Phone 1 & 2 Reports table below describes the choices. All entries must be 2 digits.

Note

This option must be turned off if using a DTIM to transmit on the regular phone line.

➤ **To set Phone 2 Reports, press:**

1. Add
2. Option #
3. 13
4. Use the numbered keys to enter 00 - 10 (see table below).
5. DONE

➤ **To turn off Phone 2 Reports (return to default), press:**

1. Delete
2. Option #
3. 13
4. DONE

Phone 1 & 2 Reports

Setting #	Content	Format
Off	None	None
00	All	SIA
01	All	Contact ID
02	Alarms only	SIA
03	Alarms only	Contact ID
04	Non-Alarms only	SIA
05	Non-Alarms only	Contact ID
06	Phone Failure (backup)	SIA
07	Phone Failure (backup)	Contact ID
08	Latchkey, No Activity, Phone Test, Openings, Closings, Fail to Open/Close, AC Power Restorals/Failures	Pager
09	Same as setting 8 plus Alarms	Pager
10	Alarms and Latchkey only (See Options 43 and 44 for more details.)	Voice Event Notification

Option 14: DTMF Dialing

(Default = on)

Determines whether the panel uses DTMF (on) or pulse (off) for dialing programmed phone numbers.

➤ **To turn on DTMF Dialing, press:**

1. Add
2. Option #
3. 14
4. DONE

➤ **To turn off DTMF Dialing, press:**

1. Delete
2. Option #
3. 14
4. DONE

Option 15: No Activity Timeout

(Default = off)

Determines whether the panel sends a No Activity report to a central station or pager when the programmed time period elapses (on), or if the feature is disabled (off).

No activity means control panel, remote handheld, and key-chain touchpad buttons have not been pressed and sensors have not been tripped within a specified period of time (except sensors in group 25).

The timeout can be set from 02 - 24 hours. All entries must be 2 digits.

➤ **To set No Activity Time-out, press:**

1. Add
2. Option #
3. 15
4. Use the numbered keys to enter a time 02 - 24 (all entries must be 2 digits).
5. DONE

➤ **To turn off No Activity Time-out, press:**

1. Delete
2. Option #
3. 15
4. DONE

Option 16: Auto Phone Test		<i>(Default = off)</i>
<p>Determines whether the panel automatically performs a periodic phone test (on) or not (off).</p> <p>The test interval can be from 001 - 254 days. Entries must be 3 digits. The time of day the panel performs the test is determined by Option 72: Supervisory Time, which must be turned on for this feature to work.</p> <p>Note For UL 1635 listed systems, Auto Phone Test must be set to 001 days.</p>	<p>➤ To set Auto Phone Test, press:</p> <ol style="list-style-type: none"> 1. Add 2. Option # 3. 16 4. Use the numbered keys to enter the number of days 001 - 254 (all entries must be 3 digits). 5. DONE <p>➤ To turn off Auto Phone Test, press:</p> <ol style="list-style-type: none"> 1. Delete 2. Option # 3. 16 4. DONE 	

Option 17: Dialer Delay		<i>(Default = 030)</i>
<p>Determines whether the panel delays dialing programmed phone numbers before sending reports (on), or if dialing begins immediately (off).</p> <p>If Option 21: Opening (Disarming) Reports is on, the panel does not delay dialing if the system is disarmed before the delay time expires. The panel dials immediately for both the alarm and opening report.</p> <p>Note Regardless of this option setting, the panel always dials immediately for alarms from sensors in groups 0-8, 26, for alarms triggered by the control panel or remote handheld touchpad emergency buttons, and for programming, AC power failure, and low battery reports.</p> <p>The delay time can be set from 005 - 254 seconds (015 to 045 if Option 69: SIA Limits is on). Entries must be 3 digits.</p> <p>Note For UL installations, the Dialer Delay must not exceed 45 seconds.</p>	<p>➤ To set Dialer Delay, press:</p> <ol style="list-style-type: none"> 1. Add 2. Option # 3. 17 4. Use the numbered keys to enter the time 005 - 254 seconds (all entries must be 3 digits). 5. DONE <p>➤ To turn off Dialer Delay, press:</p> <ol style="list-style-type: none"> 1. Delete 2. Option # 3. 17 4. DONE 	

Option 18: Alarm Cancel Report		<i>(Default = 006)</i>
<p>Sets the time frame that determines whether the panel reports an alarm cancel message to the central station.</p> <p>If the system is disarmed from an alarm state within the programmed time, the panel sends an alarm cancel message to the central station. An alarm cancel message is not reported if the system is disarmed after the programmed time expires.</p> <p>The time can be set from 006 - 255 minutes. Entries must be 3 digits. When set to 255, the panel always reports alarm cancel messages. Turning off this option disables alarm cancel reporting.</p>	<p>➤ To turn on Alarm Cancel Report, press:</p> <ol style="list-style-type: none"> 1. Add 2. Option # 3. 18 4. Use the numbered keys to enter the time 006 - 255 minutes (all entries must be 3 digits). 5. DONE <p>➤ To turn off Alarm Cancel Report, press:</p> <ol style="list-style-type: none"> 1. Delete 2. Option # 3. 18 4. DONE 	

Option 19: RF Timeout*(Default = 12 hours)*

Determines the time period the panel must receive at least one supervisory signal from learned sensors before identifying a sensor failure and sounding trouble beeps. Any sensor failure is reported immediately and again at the supervisory time (Option 72: Supervisory Time).

The timeout can be set from 02-36 hours. Entries must be 2 digits.

Note

Setting this feature to 2 hours (02) may cause false reports. For UL 1635 listed systems, RF Timeout must be set to less than 4 (04) hours. For UL 1023 listed systems, RF Timeout must be set to less than 24 hours.

➤ To change RF Timeout, press:

1. Add
2. Option #
3. 19
4. Use the numbered keys to enter the time 02 - 36 hours (all entries must be 2 digits).
5. DONE

➤ To reset RF Timeout (return to default), press:

1. Delete
2. Option #
3. 19
4. DONE

Option 20: Manual Phone Test*(Default = on)*

Determines whether the user can perform a manual phone test to verify communication to a central station/pager (on), or not (off).

➤ To turn on Manual Phone Test, press:

1. Add
2. Option #
3. 20
4. DONE

➤ To turn off Manual Phone Test, press:

1. Delete
2. Option #
3. 20
4. DONE

Option 21: Opening Reports*(Default = off)*

Determines whether the panel sends opening reports to a central station or pager whenever the system is disarmed (on), or not (off).

➤ To turn on Opening Reports, press:

1. Add
2. Option #
3. 21
4. DONE

➤ To turn off Opening Reports, press:

1. Delete
2. Option #
3. 21
4. DONE

Option 22: Closing Reports	<i>(Default = off)</i>
<p>Determines whether the panel sends closing reports to a central station or pager whenever the system is armed (on), or not (off).</p>	<p>➤ To turn on Closing Reports, press:</p> <ol style="list-style-type: none"> 1. Add 2. Option # 3. 22 4. DONE <p>➤ To turn off Closing Reports, press:</p> <ol style="list-style-type: none"> 1. Delete 2. Option # 3. 22 4. DONE

Option 23: Force Armed Report	<i>(Default = off)</i>
<p>Determines whether the panel sends a force armed report to a central station or pager if the user bypasses protesting sensors (indirect bypass) when arming the system (on), or not (off).</p>	<p>➤ To turn on Force Armed Report, press:</p> <ol style="list-style-type: none"> 1. Add 2. Option # 3. 23 4. DONE <p>➤ To turn off Force Armed Report, press:</p> <ol style="list-style-type: none"> 1. Delete 2. Option # 3. 23 4. DONE

Option 24: AC Power Failure Report	<i>(Default = off)</i>
<p>Determines whether the panel sends AC power failure reports to a central station or pager after the programmed time expires (on), or not (off).</p> <p>When the panel is without AC power for 30 seconds, the panel LEDs turn off. When the panel is without AC power for the programmed time, an AC power failure is reported. The panel reports an AC power restoral when AC power returns to the panel.</p> <p>The time can be set from 005-254 minutes. Entries must be 3 digits.</p> <p>Note For UL listed systems, AC Power Failure must be set to 15 minutes.</p>	<p>➤ To turn on AC Power Failure Report, press:</p> <ol style="list-style-type: none"> 1. Add 2. Option # 3. 24 4. Use the numbered keys to enter the time 005 - 254 minutes (all entries must be 3 digits). 5. DONE <p>➤ To turn off AC Power Failure Report, press:</p> <ol style="list-style-type: none"> 1. Delete 2. Option # 3. 24 4. DONE

Option 25: CPU Low Battery Report*(Default = on)*

Determines whether the panel sends a low CPU battery report to the central station when the panel backup battery voltage drops below 5.4 volts (on), or not (off).

Note

For UL listed systems, CPU Low Battery Report must be on.

➤ **To turn on CPU Low Battery Report, press:**

1. Add
2. Option #
3. 25
4. DONE

➤ **To turn off CPU Low Battery Report, press:**

1. Delete
2. Option #
3. 25
4. DONE

Option 26: Fail to Communicate*(Default = on)*

Determines whether the panel and interior sirens sound trouble beeps if it is unable to successfully send a report to a central station or pager (on), or not (off).

Note

For UL listed systems, Fail to Communicate must be on.

➤ **To turn on Fail to Communicate, press:**

1. Add
2. Option #
3. 26
4. DONE

➤ **To turn off Fail to Communicate, press:**

1. Delete
2. Option #
3. 26
4. DONE

Option 27: Ring/Hang/Ring*(Default = 1)*

Determines when the panel answers a remote phone access or Toolbox call. Depending on whether an answering machine exists at the panel location, off-site access to the panel can be done with a series of phone calls or just one.

For off-site access where an answering machine does not exist, the user or ToolBox operator simply calls the panel location once and listens for 10 rings. The panel should answer after the tenth ring.

For off-site access where an answering machine exists, the user or ToolBox operator must perform the following steps:

1. Call the panel location.
2. Let the phone ring once, then hang up.
3. Wait at least 10 seconds but not more than 40, then call the panel location again. The panel should answer on the first ring.

If set to 1 or 5, perform steps 1 - 3 once.

If set to 2 or 6, perform steps 1 - 3 twice.

If set to 3 or 7, perform steps 1 - 3 three times.

The table below shows the available settings.

➤ **To turn on Ring/Hang/Ring, press:**

1. Add
2. Option #
3. 27
4. Use the numbered keys to enter 1 - 7 (see table below).
5. DONE

➤ **To turn off Ring/Hang/Ring (disable remote access), press:**

1. Delete
2. Option #
3. 27
4. DONE

Ring/Hang/Ring Settings

Setting	Control Panel answers after:
1	ring/hang/ring or 10 rings
2	ring/hang/ring/hang/ring or 10 rings
3	ring/hang/ring/hang/ring/hang/ring or 10 rings
4	10 rings
5	ring/hang/ring
6	ring/hang/ring/hang/ring
7	ring/hang/ring/hang/ring/hang/ring
Off	Disabled—no remote (off-site) access

Option 28: No Delay from Keychain Touchpad

(Default = off)

Determines whether a keychain touchpad arms the system with no delay (on) or not (off).

Note

When this feature is on, the system must be disarmed before entering the premises, since it is disabling the Entry Delay. If Option 58: Remote Touchpad Arming is on, keychain touchpads cannot disarm the system and will cause an alarm upon entering.

➤ **To turn on No Delay from Keychain Touchpad, press:**

1. Add
2. Option #
3. 28
4. DONE

➤ **To turn off No Delay from Keychain Touchpad, press:**

1. Delete
2. Option #
3. 28
4. DONE

Option 29: Panel Piezo Alarms

(Default = on)

Determines whether the panel piezo emits alarm sounds (on) or not (off).

Note

For UL listed systems where this option is off, at least one UL listed external audible signal device must be used and Option 53: Hardwire Siren Supervision must be on.

➤ **To turn on Panel Piezo Alarms, press:**

1. Add
2. Option #
3. 29
4. DONE

➤ **To turn off Panel Piezo Alarms, press:**

1. Delete
2. Option #
3. 29
4. DONE

Option 30: Panel Panic Alarms*(Default = on)*

Determines whether the panel panic buttons (police, auxiliary, and fire) activate alarms when pressed (on), or not (off).

➤ To turn on Panel Panic Alarms, press:

1. Add
2. Option #
3. 30
4. DONE

➤ To turn off Panel Panic Alarms, press:

1. Delete
2. Option #
3. 30
4. DONE

Option 31: Downloader Enable*(Default = on)*

Determines whether the panel can be accessed using Tool-Box (on), or not (off).

➤ To turn on Downloader Enable, press:

1. Add
2. Option #
3. 31
4. DONE

➤ To turn off Downloader Enable, press:

1. Delete
2. Option #
3. 31
4. DONE

Option 32: 300 Baud*(Default = on)*

Determines whether the baud rate used by the panel for central station or ToolBox communication is 300 bps (on) or 110 bps (off).

➤ To turn on 300 Baud, press:

1. Add
2. Option #
3. 32
4. DONE

➤ To turn off 300 Baud, press:

1. Delete
2. Option #
3. 32
4. DONE

Option 33: Audio Verification*(Default = off)*

Determines whether the system can perform 2-way voice audio sessions with a central station operator (on), or not (off).

Note

Panel voice announcements are silenced during audio sessions. If the operator does not terminate the session correctly, panel announcements may not occur for up to 90 seconds after the operator hangs up. If this option is off, Option 47: AVM Mode and Option 48: Panic Talk—AVM will not work.

For this option to work correctly, the panel must have a 2-way voice microphone or an Interrogator 200 Audio Voice Module attached.

➤ To turn on Audio Verification, press:

1. Add
2. Option #
3. 33
4. DONE

➤ To turn off Audio Verification, press:

1. Delete
2. Option #
3. 33
4. DONE

Option 34: Fail to Open Report*(Default = off)*

Determines whether the panel sends a Fail to Open report to a central station or pager if the system has not been disarmed by the programmed time (on), or not (off).

Note

System time must be set correctly for this feature to work.

➤ To turn on Fail to Open Report, press:

1. Add
2. Option #
3. 34
4. Press the Hours +/- buttons to select the correct hour.
5. Press the Minutes +/- buttons to select the correct minute.
6. DONE

➤ To turn off Fail to Open Report, press:

1. Delete
2. Option #
3. 34
4. DONE

Option 35: Fail to Close Report*(Default = off)*

Determines whether the panel sends a Fail to Close report to a central station or pager if the system has not been armed by the programmed time (on), or not (off).

Note

System time must be set correctly for this feature to work.

➤ To turn on Fail to Close Report, press:

1. Add
2. Option #
3. 35
4. Press the Hours +/- buttons to select the correct hour.
5. Press the Minutes +/- buttons to select the correct minute.
6. DONE

➤ To turn off Fail to Close Report, press:

1. Delete
2. Option #
3. 35
4. DONE

Option 36: Sensor Activated Light Lockout Start Time		<i>(Default = off)</i>
<p>Sets the START time that determines when the panel prevents the sensor activated lights feature from turning on sensor activated lights.</p> <p>Note <i>System time must be set correctly for this feature to work.</i></p> <p>When a time value is set (on) and the sensor activated lights feature is on, the panel prevents sensor activated lights from turning on between the programmed start time (this option) and the programmed stop time (Option 37).</p> <p>Note <i>Both Options 36 and 37 must have a time programmed for this feature to work correctly.</i></p> <p>When both Options 36 and 37 are turned off and the sensor activated lights feature is on, sensor activated lights turn on at all times.</p>	<p>➤ To set Sensor Activated Light Lockout Start Time, press:</p> <ol style="list-style-type: none"> 1. Add 2. Option # 3. 36 4. Press the Hours +/- buttons to select the correct hour. 5. Press the Minutes +/- buttons to select the correct minute. 6. DONE <p>➤ To turn off Sensor Activated Light Lockout Start Time, press:</p> <ol style="list-style-type: none"> 1. Delete 2. Option # 3. 36 4. DONE 	

Option 37: Sensor Activated Light Lockout Stop Time		<i>(Default = off)</i>
<p>Sets the STOP time that determines when the panel prevents the sensor activated lights feature from turning on sensor activated lights.</p> <p>Note <i>System time must be set correctly for this feature to work.</i></p> <p>When a time value is set (on) and the sensor activated lights feature is on, the panel prevents sensor activated lights from turning on between the programmed start time (Option 36) and the programmed stop time (this option).</p> <p>Note <i>Both Options 36 and 37 must have a time programmed for this feature to work correctly.</i></p> <p>When both Options 36 and 37 are turned off and the sensor activated lights feature is on, sensor activated lights turn on at all times.</p>	<p>➤ To set Sensor Activated Light Lockout Stop Time, press:</p> <ol style="list-style-type: none"> 1. Add 2. Option # 3. 37 4. Press the Hours +/- buttons to select the correct hour. 5. Press the Minutes +/- buttons to select the correct minute. 6. DONE <p>➤ To turn off Sensor Activated Light Lockout Stop Time, press:</p> <ol style="list-style-type: none"> 1. Delete 2. Option # 3. 37 4. DONE 	

Option 38: Auto Arm*(Default = on)*

Determines how long the system protests (announces open/failed sensors) when attempting to arm with open/failed sensors, before bypassing these sensors and automatically arming the rest of the system.

Note

The panel protests an arming attempt when it has not received a restore (close) signal from sensors learned into restore-specific sensor groups. Sensors learned into group 26 (Fire) cannot be bypassed. See "Sensor Group Characteristics" in "Appendix B" to identify sensor groups with restore signal requirements.

When this option is on, the panel announces all open/failed sensors repeatedly for 4 minutes, then automatically bypasses the open sensors and arms the rest of the system. If a sensor is opened during the exit delay and then left open, the panel will go into alarm after the exit delay has expired.

Note

This option must be on for Option 52 and 59: Unvacated Premises and Exit Extension to work correctly.

If there are open sensors, pressing the ARM Doors & Windows button a second time (before the 4-minute time expires) bypasses all open sensors and arms the rest of the system. Pressing this button a third time eliminates the entry delay.

If there are no open sensors, pressing the ARM Doors & Windows button a second time (before the exit delay expires) eliminates the entry delay.

Note

For UL Listed systems, this option must be on.

When this option is off, the panel announces all open/failed sensors once, then automatically bypasses the open sensors and arms the rest of the system after the exit delay has expired. If other sensors are opened during the exit delay, they will also be bypassed if left open.

Note

If a Group 13 (Instant Perimeter) sensor is opened during the exit delay, the panel goes into immediate alarm.

➤ **To turn on Auto Arm, press:**

1. Add
2. Option #
3. 38
4. DONE

➤ **To turn off Auto Arm, press:**

1. Delete
2. Option #
3. 38
4. DONE

Option 39: Siren Timeout*(Default = 004 minutes)*

Determines how long sirens sound alarms if no one is present to disarm the system.

The time can be set from 002 - 254 minutes. Entries must be 3 digits. When this feature is turned off, sirens sound alarms until the alarm is canceled (system is disarmed).

Note

For UL listed systems, Siren Timeout must be set to at least 4 minutes.

➤ **To set Siren Timeout, press:**

1. Add
2. Option #
3. 39
4. Use the numbered keys to enter the time 002 - 254 minutes (all entries must be 3 digits).
5. DONE

➤ **To turn off Siren Timeout, press:**

1. Delete
2. Option #
3. 39
4. DONE

Option 40: Trouble Beeps		<i>(Default = on)</i>
<p>Determines whether the panel, X10, and hardwire interior sirens sound six beeps every minute when a trouble condition occurs (on) or not (off). The following conditions cause trouble beeps:</p> <ul style="list-style-type: none"> • AC power failure (when Option 24 is on) • Low CPU battery • Sensor failure (supervisory) • Sensor trouble (i.e. low battery, tamper, etc.) • Fail to communicate • Restoration of Power (if no DTIM installed) • No Activity timer has timed out. Trouble beeps continue for 5 minutes and if the panel does not see activity, trouble beeps stop and the panel reports the no activity to the central station. <p>Trouble beeps can be silenced by arming or disarming the system, or by pressing the STATUS button. Trouble beeps resume 4 hours later if the trouble condition is not cleared.</p> <p>Note For UL listed systems, Trouble Beeps must be on.</p>	<p>➤ To turn on Trouble Beeps, press:</p> <ol style="list-style-type: none"> 1. Add 2. Option # 3. 40 4. DONE <p>➤ To turn off Trouble Beeps, press:</p> <ol style="list-style-type: none"> 1. Delete 2. Option # 3. 40 4. DONE 	

Option 41: Chime Voice		<i>(Default = off)</i>
<p>Determines whether the panel announces the sensor number and name (on) or only sounds beeps (off), when the CHIME Doors or CHIME Special Motion features are on and sensors in groups 10, 13, and 25 are tripped while the system is disarmed.</p>	<p>➤ To turn on Chime Voice, press:</p> <ol style="list-style-type: none"> 1. Add 2. Option # 3. 41 4. DONE <p>➤ To turn off Chime Voice, press:</p> <ol style="list-style-type: none"> 1. Delete 2. Option # 3. 41 4. DONE 	

Option 42: Speaker Level		<i>(Default = 8)</i>
<p>Sets the volume of voice messages from the panel speaker.</p> <p>The volume can be set from 1 (lowest) to 8 (highest). Resetting this option returns the setting to the default value.</p> <p>This option returns to the default setting (8) when deleted.</p>	<p>➤ To set Speaker Level, press:</p> <ol style="list-style-type: none"> 1. Add 2. Option # 3. 42 4. Use the numbered keys to enter 1 - 8. 5. DONE <p>➤ To reset Speaker Level (return to default), press:</p> <ol style="list-style-type: none"> 1. Delete 2. Option # 3. 42 4. DONE 	

Option 43: Numeric Pager/Voice Event Notification Phone Number

(Default = off)

Lets you program up to a 26-digit phone number for numeric pager or voice event notification (on), or delete an existing phone number (off).

When used to call a numeric pager, a 3-digit code appears on the pager display to identify the report. When used to call a remote phone (Voice Event Notification), a person at the remote phone location can hear system voice alarm announcements. See the "Testing" section for more information.

Press Test for each required pause, Add for a *, and Delete for a # (each of which uses one of the 26 available places).

Note

Some pagers may require more than 3 or 4 additional pauses after the last digit to work correctly (see Option 05).

Pressing DONE is required if you enter fewer than 26 digits. The phone number is automatically stored without pressing DONE if all 26 places are used.

➤ **To set Numeric Pager/Voice Event Notification Phone Number, press:**

1. Add
2. Option #
3. 43
4. Use the numbered keys to enter the phone number (up to 26 digits).
5. DONE

➤ **To delete Numeric Pager/Voice Event Notification Phone Number, press:**

1. Delete
2. Option #
3. 43
4. DONE

Option 44: Numeric Pager/Voice Event Notification Phone 3 Reports

(Default = off)

Determines the report content and reporting format when Option 43: Numeric Pager/Voice Event Notification Phone Number is programmed. The table below describes the choices. All entries must be 2 digits.

➤ **To set Numeric Pager/Voice Event Notification Phone 3 Reports, press:**

1. Add
2. Option #
3. 44
4. Use the numbered keys to enter 08, 09 or 10 (all entries must be 2 digits).
5. DONE

➤ **To turn off Numeric Pager/Voice Event Notification Phone 3 Reports (return to default), press:**

1. Delete
2. Option #
3. 44
4. DONE

Phone 3 Reports

Setting #	Content	Format
Off	None	None
08	Latchkey, No Activity, Phone Test, Openings, Closings, Fail to Open/Close, AC Power Restorals/Failures	Numeric Pager
09	Same as setting 8 plus Alarms	Numeric Pager
10	Alarms and Latchkey only	Voice Event Notification

Option 45: Sensor Alarm Restoral Report*(Default = off)*

Determines whether the panel reports sensor alarm restorals (on), or not (off). The table below describes the possible settings.

➤ **To turn on Sensor Alarm Restoral Report, press:**

1. Add
2. Option #
3. 45
4. Use the numbered keys to enter 1, 2 or 3.
5. DONE

➤ **To turn off Sensor Alarm Restoral Report, press:**

1. Delete
2. Option #
3. 45
4. DONE

Sensor Alarm Restoral Settings

Setting	When Restorals are Reported
Off	No restoral reporting
1	Immediately after sensor is closed or restored after dial delay
2	After siren timeout expires if sensor is restored
3	When system is disarmed if sensor is restored

Option 46: Fire Shutdown - AVM*(Default = off)*

Determines whether system sirens are silenced during a 2-way audio session (on) or not (off). Beeps sound every 10 seconds while sirens are silenced.

➤ **To turn on Fire Shutdown - AVM, press:**

1. Add
2. Option #
3. 46
4. DONE

➤ **To turn off Fire Shutdown - AVM, press:**

1. Delete
2. Option #
3. 46
4. DONE

Option 47: AVM Mode		<i>(Default = off)</i>
<p>Determines whether the panel hangs up and waits for a callback from the central station operator before starting an audio session (on), or stays on line with the central station for an instant audio session (off).</p> <p>Note Option 33: Audio Verification must be on for this feature to work.</p>	<p>➤ To set AVM Mode to Callback, press:</p> <ol style="list-style-type: none"> 1. Add 2. Option # 3. 47 4. DONE <p>➤ To set AVM Mode to Instant, press:</p> <ol style="list-style-type: none"> 1. Delete 2. Option # 3. 47 4. DONE 	

Option 48: Panic Talk - AVM		<i>(Default = off)</i>
<p>Determines whether the central station operator can talk to the user during a silent alarm (off) or just listen in on the premises (on).</p> <p>Silent alarms occur when sensors learned into groups 02 or 03 are tripped, when the Panic Code is entered, or when the panel Police button is pressed and Option 74: Silent Panel Police Panic is turned on.</p> <p>Note Option 33: Audio Verification must be on for this feature to work.</p>	<p>➤ To turn on Panic Talk - AVM, press:</p> <ol style="list-style-type: none"> 1. Add 2. Option # 3. 48 4. DONE <p>➤ To turn off Panic Talk - AVM, press:</p> <ol style="list-style-type: none"> 1. Delete 2. Option # 3. 48 4. DONE 	

Option 49: Arming LEDs Shutdown		<i>(Default = off)</i>
<p>Determines whether the panel LEDs (buttons) turn off 30 seconds after the last button press (on), or remain on for the entire arming period (off).</p>	<p>➤ To turn on Arming LEDs Shutdown, press:</p> <ol style="list-style-type: none"> 1. Add 2. Option # 3. 49 4. DONE <p>➤ To turn off Arming LEDs Shutdown, press:</p> <ol style="list-style-type: none"> 1. Delete 2. Option # 3. 49 4. DONE 	

Option 50: RF Jam Detect*(Default = off)*

Determines whether the panel checks for and reports RF interference/jam to the central station (on), or not (off).

If this option is on and the panel receives a constant 319.5 MHz signal, the panel speaker announces “RF Failure” and reports the condition to the central station. Touchpads will announce “Option 50 Detected”. If this option is off, the panel does not detect an RF jam.

Note

For UL listed systems, RF Jam Detect must be on.

➤ To turn on RF Jam Detect, press:

1. Add
2. Option #
3. 50
4. DONE

➤ To turn off RF Jam Detect, press:

1. Delete
2. Option #
3. 50
4. DONE

Option 51: 24 Hour Sensor Tamper*(Default = off)*

Determines whether the system (armed or disarmed) goes into and reports an alarm anytime a sensor tamper switch is tripped (on), or only when the system is armed and a tamper switch of an armed sensor is tripped (off).

➤ To turn on 24 Hour Tamper, press:

1. Add
2. Option #
3. 51
4. DONE

➤ To turn off 24 Hour Tamper, press:

1. Delete
2. Option #
3. 51
4. DONE

Option 52: Unvacated Premises*(Default = on)*

Determines whether the system automatically arms down to level 2 (ARM Doors & Windows) if the user arms the system to level 4 (ARM Doors & Windows, + ARM Motion Sensors) without leaving the premises (on), or remains at the armed level chosen by the user (off).

Note

If Options 81 and 82 are programmed, the RF Thermostat will change from Energy Saving Mode to normal operating mode when the panel is armed to level 2.

This feature does not work from a keychain touchpad.

Option 38: Auto Arm must be on for this feature to work.

➤ To turn on Unvacated Premises, press:

1. Add
2. Option #
3. 52
4. DONE

➤ To turn off Unvacated Premises, press:

1. Delete
2. Option #
3. 52
4. DONE

Option 53: Hardwire Siren Supervision*(Default = off)*

Determines whether the panel monitors hardwired sirens for open conditions (on), or not (off).

If this option is turned on, sirens connected to the panel terminals require an EOL resistor in the wire circuit (see “Installing the System” for siren wiring). If this option is turned off, EOL resistors are not required whether sirens are connected or not.

Note

For UL listed systems, this feature must be on and EOL resistors installed. Also for UL Listed systems, this feature must be on if Option 29: Panel Piezo Alarms is off.

➤ **To turn on Hardwire Siren Supervision, press:**

1. Add
2. Option #
3. 53
4. DONE

➤ **To turn off Hardwire Siren Supervision, press:**

1. Delete
2. Option #
3. 53
4. DONE

Option 54: Access Code Length*(Default = 4)*

Determines how many digits are in all access codes.

Turning on this option lets you set the access code length to 3, 4, 5, or 6 digits. Turning off this option resets the access code length to the default setting, resets Master, Utility 1, and Utility access codes.

Read the following before changing this option.

- This option affects all system access codes (Master, Utility 1, Utility 2, Panic, and User).
- Changing the access code length changes the Master, Utility 1, and Utility 2 access codes to their respective defaults as described in the table below.

Note

Changing the Access Code Length clears/deletes any User Codes that were previously programmed. If the customer wants the Access Code Length changed, it should be set before programming any new (unprogrammed) access codes, whenever possible.

➤ **To change Access Code Length, press:**

1. Add
2. Option #
3. 54
4. Use the numbered keys to enter 3, 4, 5 or 6.
5. DONE

➤ **To reset Access Code Length (to default), press:**

1. Delete
2. Option #
3. 54
4. DONE

Access Code Length Defaults

Setting	Default Code
3	Master—123 Utility 1—321 Utility 2—321
4	Master—1234 Utility 1—4321 Utility 2—4321
5	Master—12345 Utility 1—54321 Utility 2—54321
6	Master—123456 Utility 1—654321 Utility 2—654321

Option 55: Status Beep Volume*(Default = 07)*

Determines the panel piezo volume level for status sounds such as arming, trouble, and status beeps.

The volume can be set from 1 (lowest) to 10 (highest). Resetting this option returns the volume to the default setting. Entries must be 2 digits.

This option returns to the default setting (07) when deleted.

➤ **To set Status Beep Volume, press:**

1. Add
2. Option #
3. 55
4. Use the numbered keys to enter 01 - 10 (entries must be 2 digits).
5. DONE

➤ **To reset Status Beep Volume (return to default), press:**

1. Delete
2. Option #
3. 55
4. DONE

Option 56: Call Waiting*(Default = off)*

Lets you program up to a 26-digit number or code that disables call waiting or any other phone service before dialing central station, pager, or voice event notification phone numbers (on). When this option is turned off, the panel dials only the central station or pager phone numbers.



DO NOT change Option 56 from its default if the customer doesn't have call waiting. Verify with the customer that they have call waiting with their phone service provider before changing this option from its default. Changing this option from its default without call waiting will prohibit the panel from calling the central station.

Caution

Press Test for each required pause, Add for a *, and Delete for a # (each of which uses one of the 26 available places).

Note

Pressing DONE is required if you enter fewer than 26 digits. The phone number is automatically stored without pressing DONE if all 26 places are used.

➤ **To program Call Waiting, press:**

1. Add
2. Option #
3. 56
4. Use the numbered keys to enter the phone number (up to 26 digits).
5. DONE

➤ **To delete Call Waiting, press:**

1. Delete
2. Option #
3. 56
4. DONE

Option 57: Supervisory/Tamper Report*(Default = off)*

Determines whether the panel sends supervisory reports to a central station as a tamper (on) or a supervisory (off).

Note

This option is typically used only in Europe where a supervisory condition is required to report as a tamper.

➤ **To report supervisories as Tamper Reports, press:**

1. Add
2. Option #
3. 57
4. DONE

➤ **To report supervisories as Supervisory Reports, press:**

1. Delete
2. Option #
3. 57
4. DONE

Option 58: Remote Touchpad Arming*(Default = off)*

Determines whether keychain and remote touchpads can disarm the system only during exit and entry delays (on), or arm and disarm the system anytime (off).

**Caution**

If this option and Option 28 (No Delay from Keychain Touchpad) are on, users cannot enter and/or disarm using remote touchpads without causing an alarm.

➤ **To turn on Remote Touchpad Arming, press:**

1. Add
2. Option #
3. 58
4. DONE

➤ **To turn off Remote Touchpad Arming, press:**

1. Delete
2. Option #
3. 58
4. DONE

Option 59: Exit Extension*(Default = on)*

Determines whether the panel restarts the exit delay time if the user enters the armed premises during the initial exit delay period (on), or not (off).

Turning on this feature allows users to re-enter during the exit delay period, without disarming and then re-arming the system. Turning off this feature requires the user to disarm and re-arm the system.

Note

Option 38 must be ON for exit extension to work.

For UL listed systems, Exit Extension must be off.

➤ **To turn on Exit Extension, press:**

1. Add
2. Option #
3. 59
4. DONE

➤ **To turn off Exit Extension, press:**

1. Delete
2. Option #
3. 59
4. DONE

Option 60: Secure Arming*(Default = off)*

Determines whether an access code is required when arming the system (on) or not (off).

This option does not affect keychain touchpad arm/disarm operation.

➤ **To turn on Secure Arming, press:**

1. Add
2. Option #
3. 60
4. DONE

➤ **To turn off Secure Arming, press:**

1. Delete
2. Option #
3. 60
4. DONE

Option 61: Demo Mode*(Default = off)*

Determines whether the panel operates as a demonstration model (on) or a standard panel (off).

Turning on this feature disables low battery supervision and allows the microphone to remain on continuously during an AVM session. System time setting is not required when this setting is on.

➤ To turn on Demo Mode, press:

1. Add
2. Option #
3. 61
4. DONE

➤ To turn off Demo Mode, press:

1. Delete
2. Option #
3. 61
4. DONE

Option 62: Supervisory Protest*(Default = off)*

Determines whether the panel protests arming if it has not received a supervisory signal from any sensor 15 minutes before arming (on) or not (off).

Note

This feature must be turned on for European installations, but turned off for U.S. installations.

➤ To turn on Supervisory Protest, press:

1. Add
2. Option #
3. 62
4. DONE

➤ To turn off Supervisory Protest, press:

1. Delete
2. Option #
3. 62
4. DONE

Option 63: 24 Hour Time*(Default = off)*

Determines whether the panel uses a 24-hour clock (on) or 12-hour clock (off).

➤ To turn on 24 Hour Time, press:

1. Add
2. Option #
3. 63
4. DONE

➤ To turn off 24 Hour Time, press:

1. Delete
2. Option #
3. 63
4. DONE

Option 64: No Arm on Panel Low Battery*(Default = off)*

Determines whether the system prevents users from arming if a low CPU battery condition exists (on) or not (off).

➤ **To turn on No Arm on Panel Low Battery, press:**

1. Add
2. Option #
3. 64
4. DONE

➤ **To turn off No Arm on Panel Low Battery, press:**

1. Delete
2. Option #
3. 64
4. DONE

Option 65: No Usage Report*(Default = off)*

Determines whether the panel sends a No Usage report to the central station if the user has not operated the system before the programmed time expires (on) or not (off). The timer starts each time the system is disarmed.

This is a customer service feature that alerts the central station if a customer is not using their security system. The service provider can then contact the customer to find out why the system is not being used, and help correct any problems for the customer.

The time can be set from 001 to 254 days. Entries must be 3 digits.

➤ **To turn on No Usage Report, press:**

1. Add
2. Option #
3. 65
4. Use the numbered keys to enter 001 - 254 days (entries must be 3 digits).
5. DONE

➤ **To turn off No Usage Report, press:**

1. Delete
2. Option #
3. 65
4. DONE

Option 66: External Siren Delay*(Default = off)*

Determines whether external siren activation is delayed 30 seconds after an alarm caused by a delayed sensor (on), or if external siren activation is immediate upon alarm activation (off).

➤ **To turn on External Siren Delay, press:**

1. Add
2. Option #
3. 66
4. DONE

➤ **To turn off External Siren Delay, press:**

1. Delete
2. Option #
3. 66
4. DONE

Option 67: Quick Exit	<i>(Default = off)</i>
<p>Determines whether pressing the Disarm button when the system is armed activates the exit delay time to allow exit and re-entry without disarming the system (on) or not (off).</p> <p>This feature is useful if the user wants to step outside briefly and return, such as to get the paper. If the system is armed and the user presses the Disarm button, the panel announces "Exit time on" and sounds exit delay beeps. This allows a designated entry/exit door to be open for up to 2 minutes without causing an alarm. When the door is closed, the beeps stop and the door is armed again.</p> <p>Note For UL listed systems, Quick Exit must be off.</p>	<p>➤ To turn on Quick Exit, press:</p> <ol style="list-style-type: none"> 1. Add 2. Option # 3. 67 4. DONE <p>➤ To turn off Quick Exit, press:</p> <ol style="list-style-type: none"> 1. Delete 2. Option # 3. 67 4. DONE

Option 68: Swinger Shutdown	<i>(Default = on)</i>
<p>Determines whether the panel prevents the same sensor from activating an alarm more than once in a single arming period (on) or not (off).</p> <p>Note Swinger Shutdown does not affect smoke and fire sensors.</p>	<p>➤ To turn on Swinger Shutdown, press:</p> <ol style="list-style-type: none"> 1. Add 2. Option # 3. 68 4. DONE <p>➤ To turn off Swinger Shutdown, press:</p> <ol style="list-style-type: none"> 1. Delete 2. Option # 3. 68 4. DONE

Option 69: SIA Limits	<i>(Default = on)</i>
<p>Determines whether Entry, Exit, and Dialer delay times fall within SIA limits (on) or factory ranges (off).</p> <p>The table below shows the available settings when this option is on or off.</p> <p>Note If options 10, 11 or 17 are set outside the SIA limits while Option 69 is OFF, turning Option 69 ON will not affect options 10, 11 or 17 until they are manually changed.</p> <p><i>Not investigated for use by UL.</i></p> <p>Note When this option is off, there are no CS reports for sensor tests.</p>	<p>➤ To turn on SIA Limits, press:</p> <ol style="list-style-type: none"> 1. Add 2. Option # 3. 69 4. DONE <p>➤ To turn off SIA Limits, press:</p> <ol style="list-style-type: none"> 1. Delete 2. Option # 3. 69 4. DONE

SIA Limits

Affected Option	SIA Limits (Option 69 on)	Factory Ranges (Option 69 off)
Option 10: Entry Delay	030-254 seconds	005-254 seconds

SIA Limits

Affected Option	SIA Limits (Option 69 on)	Factory Ranges (Option 69 off)
Option 11: Exit Delay	045-254 seconds	005-254 seconds
Option 17: Dialer Delay	015-045 seconds	005-254 seconds

Option 70: Not Available

Option 71: Programming Report

(Default = off)

Determines whether the panel sends a report to the central station anytime the programming mode is entered/exited (on) or not at all (off).

The panel sends a report whenever the dealer (Utility 1) or installer (Utility 2) code is used to enter programming mode and another report is sent when the programming session ends (when the cover is closed).

➤ **To turn on Programming Report, press:**

1. Add
2. Option #
3. 71
4. DONE

➤ **To turn off Programming Report, press:**

1. Delete
2. Option #
3. 71
4. DONE

Option 72: Supervisory Time

(Default = 12:00am)

Determines when the panel reports supervisory conditions (sensor failures) and automatic phone tests to the central station.

Note

The panel clock must be set to the correct time for this option and Option 16: Auto Phone Test to work correctly.

➤ **To set Supervisory Time, press:**

1. Add
2. Option #
3. 72
4. Press the Hours +/- buttons to select the correct hour.
5. Press the Minutes +/- buttons to select the correct minute.
6. DONE

➤ **To turn off (disable) Supervisory Time, press:**

1. Delete
2. Option #
3. 72
4. DONE

Option 73: Modem Sensitivity*(Default = off)*

Determines whether the modem sensitivity is set to normal (off) or high (on).

Note

This feature should be used only if the panel experiences consistent trouble reporting to the central station. Otherwise, leave this option off.

➤ To turn on Modem Sensitivity, press:

1. Add
2. Option #
3. 73
4. DONE

➤ To turn off Modem Sensitivity, press:

1. Delete
2. Option #
3. 73
4. DONE

Option 74: Silent Panel Police Panic*(Default = off)*

Determines whether pressing the panel police panic button causes an audible (off) or silent (on) alarm.

Note

For UL Listed systems, this option must be off (audible).

➤ To turn on Silent Panel Police Panic, press:

1. Add
2. Option #
3. 74
4. DONE

➤ To turn off Silent Panel Police Panic, press:

1. Delete
2. Option #
3. 74
4. DONE

Option 75: VOX Mic Gain*(Default = 14)*

Sets the mic gain (sensitivity) that triggers the voice-activated switching (VOX).

Room size, acoustics, and furnishings where the panel or Interrogator 200 are located will influence the setting. The available settings are 01 (low) - 64 (high). Entries must be 2 digits.

For panels with a built-in microphone, a setting of 14 is recommended. For systems using the Interrogator 200, a setting of 7 should be used.

➤ To set VOX Mic Gain, press:

1. Add
2. Option #
3. 75
4. Use the numbered keys to enter 01 - 64 (entries must be 2 digits).
5. DONE

➤ To reset VOX Mic Gain (return to default), press:

1. Delete
2. Option #
3. 75
4. DONE

Option 76: VOX Gain Range	<i>(Default = 64)</i>
<p>Sets the gain range for the voice-activated switching (VOX).</p> <p>The available settings are 01 (low) - 64 (high). Entries must be 2 digits.</p> <p>For best results, this option should be set equal to or greater than Option 75: VOX Mic Gain. For panels with a built-in microphone, this option should be set to the default value.</p> <p>Note <i>This option works in conjunction with Option 75: VOX Mic Gain. It is important to follow the setting recommendations as described to achieve acceptable operation.</i></p>	<p>➤ To set VOX Gain Range, press:</p> <ol style="list-style-type: none"> 1. Add 2. Option # 3. 76 4. Use the numbered keys to enter 01 - 64 (entries must be 2 digits). 5. DONE <p>➤ To reset VOX Gain Range (return to default), press:</p> <ol style="list-style-type: none"> 1. Delete 2. Option # 3. 76 4. DONE

Option 77: Manual Mic Gain	<i>(Default = 64)</i>
<p>Determines the gain level (sensitivity) during 2-way audio sessions, when Option 33: Audio Verification is set to 0 or 1 (Speak).</p> <p>Room size, acoustics, and furnishings where the panel or Interrogator 200 are located will influence the setting. The available settings are 01 (low) - 64 (high). Entries must be 2 digits.</p> <p>For panels with a built-in microphone, a setting of 64 is recommended. For systems using the Interrogator 200, a setting of 20 should be used.</p>	<p>➤ To set Manual Mic Gain, press:</p> <ol style="list-style-type: none"> 1. Add 2. Option # 3. 77 4. Use the numbered keys to enter 01 - 64 (entries must be 2 digits). 5. DONE <p>➤ To reset Manual Mic Gain (return to default), press:</p> <ol style="list-style-type: none"> 1. Delete 2. Option # 3. 77 4. DONE

Option 78: VOX Receiver Gain	<i>(Default = 06)</i>
<p>Determines the receiver gain level during 2-way audio sessions.</p> <p>If the VOX is switching the speaker on when the central station operator is not talking, lower both this setting and Option 75: VOX Mic Gain setting. If the VOX is not switching the speaker on when the central station operator is talking, raise this setting and lower Option 75: VOX Mic Gain setting.</p> <p>Note <i>Changing this setting does not affect speaker volume.</i></p> <p>This option can be set from 01 - 10. Entries must be 2 digits.</p>	<p>➤ To set VOX Receiver Gain, press:</p> <ol style="list-style-type: none"> 1. Add 2. Option # 3. 78 4. Use the numbered keys to enter 01 - 10 (entries must be 2 digits). 5. DONE <p>➤ To reset VOX Receiver Gain (return to default), press:</p> <ol style="list-style-type: none"> 1. Delete 2. Option # 3. 78 4. DONE

Option 79: Panel Cover Tamper*(Default = off)*

Determines whether the panel activates a tamper alarm anytime the cover is opened (on), or only when the system is armed (off).

To enter program mode when this option is on, you must first enter the Master Access code, then open the cover and enter program mode within 10 seconds.

➤ To turn on Panel Cover Tamper, press:

1. Add
2. Option #
3. 79
4. DONE

➤ To turn off Panel Cover Tamper (return to default), press:

1. Delete
2. Option #
3. 79
4. DONE

Option 80: Alarm Report Verification*(Default = off)*

Determines whether the panel verifies successful alarm reports to the central station/pager with the voice message "Phone communication okay" (on), or not (off).

➤ To turn on Alarm Report Verification, press:

1. Add
2. Option #
3. 80
4. DONE

➤ To turn off Alarm Report Verification (return to default), press:

1. Delete
2. Option #
3. 80
4. DONE

Option 81: Heating Set Point*(Default = off)*

If the room temperature falls below the Heating Set Point, the RF Electronic Thermostat will turn the furnace on until the room temperature returns to the Heating Set Point.

The Heating Set Point can be set between 51°F and 91°F

See the *Dialog RF Electronic Thermostat Instructions (466-1931)* for more information on its use.

➤ To adjust Heating Set Point, press:

1. Add
2. Option #
3. 81
4. Use the numbered keys to enter 51 - 91.
5. DONE

➤ To turn off Heating Set Point (return to default), press:

1. Delete
2. Option #
3. 81
4. DONE

Option 82: Cooling Set Point		<i>(Default = off)</i>
<p>If the room temperature rises above the Cooling Set Point, the RF Electronic Thermostat will turn the air conditioner on until the room temperature returns to the Cooling Set Point.</p> <p>The Cooling Set Point can be set between 51°F and 91°F</p> <p>See the <i>Dialog RF Electronic Thermostat Instructions (466-1931)</i> for more information on its use.</p>	<p>➤ To adjust Cooling Set Point, press:</p> <ol style="list-style-type: none"> 1. Add 2. Option # 3. 82 4. Use the numbered keys to enter 51 - 91. 5. DONE <p>➤ To turn off Cooling Set Point (return to default), press:</p> <ol style="list-style-type: none"> 1. Delete 2. Option # 3. 82 4. DONE 	

Option 83: X10/RF Light Control		<i>(Default = off)</i>
<p>Determines what type of light control will be used by the panel.</p> <p>If this option is on, the panel uses the GE RF light control modules to control lights.</p> <p>If this option is off, the panel uses X10 modules to control lights.</p>	<p>➤ To turn on X10/RF Light Control, press:</p> <ol style="list-style-type: none"> 1. Add 2. Option # 3. 83 4. DONE <p>➤ To turn off X10/RF Light Control (return to default), press:</p> <ol style="list-style-type: none"> 1. Delete 2. Option # 3. 83 4. DONE 	

Option 84: European Compliance		<i>(Default = off)</i>
For European installations.		

Option 85: Smoke Supervision		<i>(Default = off)</i>
<p>Determines how often the panel must receive supervisory signals from the smoke sensors.</p> <p>If this option is on, the panel must receive at least one supervisory signal from smoke sensors every four hours or it will identify a sensor failure and sound trouble beeps.</p> <p>If this option is off, the time for receiving supervisory signals is determined by Option 19: RF Timeout.</p> <p>Note For UL 985 listed systems, option 85 must be set to on.</p>	<p>➤ To turn on Smoke Supervision, press:</p> <ol style="list-style-type: none"> 1. Add 2. Option # 3. 85 4. DONE <p>➤ To turn off Smoke Supervision (return to default), press:</p> <ol style="list-style-type: none"> 1. Delete 2. Option # 3. 85 4. DONE 	

Option 86: Fire Alarm Verify (Default = off)

Determines when a fire alarm is reported to the central station.

If this option is on, a single smoke sensor must stay in alarm for at least one minute before the panel reports the alarm to the central station. If a second (different) smoke sensor goes into alarm before the Siren Timeout (Option 39) expires, the panel immediately reports the alarm to the central station.

If this option is off, the panel immediately reports an alarm to the central station when a smoke sensor goes into alarm.

➤ **To turn on Fire Alarm Verify, press:**

1. Add
2. Option #
3. 86
4. DONE

➤ **To turn off Fire Alarm Verify (return to default), press:**

1. Delete
2. Option #
3. 86
4. DONE

Option 87: 2-Way RF Touchpad Voice (Default = off)

Determines the amount of broadcast speech that is sent to 2-Way RF touchpads (Dialog QS1500 Touchtalk Interactive Keypad).

If this option is on, the panel will send broadcast speech messages to the touchpads for arming, disarming, alarm cancel and dialer abort events.

If this option is off, the panel only sends broadcast speech messages to the touchpads for voice chime events.

See the *Dialog QS1500 Touchtalk Interactive Keypad Instructions (466-2105)* for more information on its use.

➤ **To turn on 2-Way RF Touchpad Voice, press:**

1. Add
2. Option #
3. 87
4. DONE

➤ **To turn off 2-Way RF Touchpad Voice (return to default), press:**

1. Delete
2. Option #
3. 87
4. DONE

Option 88: Custom Defaults

Important !

DO NOT attempt to change or program this option without authorization from GE Security. Changing this option could make your panel inoperable.

Option 89: Serial Port Protocol (Default = off)

Determines if the Ethernet Interface module is enabled.

If this option is on, the Ethernet Interface module protocol on the serial port connector is enabled.

If this option is off, the downloader protocol on the serial port connector is disabled.

➤ **To turn on Serial Port Protocol, press:**

1. Add
2. Option #
3. 89
4. DONE

➤ **To turn off Serial Port Protocol (return to default), press:**

1. Delete
2. Option #
3. 89
4. DONE

Option 90: Comm Channel 1 Reports*(Default = off)*

The setting for this option determines which reports are sent to central station receiver 1 by the Ethernet Interface module.

- Off = no reports
- 0 = all event reports
- 1 = alarms and manual comm test

Note

When this option is on, only SIA accounts will report phone communication failures to premisesconnect.com.

➤ To set Comm Channel 1 Reports, press:

1. Add
2. Option #
3. 90
4. Use the numbered keys to enter 0 or 1.
5. DONE

➤ To turn off Comm Channel 1 Reports (return to default), press:

1. Delete
2. Option #
3. 90
4. DONE

Option 91: Comm Channel 2 Reports*(Default = off)*

The setting for this option determines which reports are sent to central station receiver 2 by the Ethernet Interface module.

- Off = no reports
- 0 = all event reports
- 1 = alarms and manual comm test

Note

When this option is on, only SIA accounts will report phone communication failures to premisesconnect.com.

➤ To set Comm Channel 2 Reports, press:

1. Add
2. Option #
3. 91
4. Use the numbered keys to enter 0 or 1.
5. DONE

➤ To turn off Comm Channel 2 Reports (return to default), press:

1. Delete
2. Option #
3. 91
4. DONE

Option 92: Comm Channel 3 Reports*(Default = off)*

The setting for this option determines which reports are sent to premisesconnect.com by the Ethernet Interface module.

- Off = no reports
- 0 = all event reports

Note

When this option is on, only SIA accounts will report phone communication failures to premisesconnect.com.

➤ To set Comm Channel 3 Reports, press:

1. Add
2. Option #
3. 92
4. Use the numbered keys to enter 0.
5. DONE

➤ To turn off Comm Channel 3 Reports (return to default), press:

1. Delete
2. Option #
3. 92
4. DONE

Option 93: DTIM Reports Phone 1*(Default = off)*

The setting for this option determines what events the DTIM reports on phone 1 (Option 04).

Note

See *Option 12: Phone 1 Reports*, for more information on Phone 1 reporting formats.

- Off = no reports
- 0 = all events SIA format
- 1 = all events CID format
- 2 = alarms and manual phone test SIA format
- 3 = alarms and manual phone test CID format
- 4 = non alarms only SIA format
- 5 = non alarms only CID format

➤ **To set DTIM Reports Phone 1, press:**

1. Add
2. Option #
3. 93
4. Use the numbered keys to enter 0 - 5.
5. DONE

➤ **To turn off DTIM Reports Phone 1 (return to default), press:**

1. Delete
2. Option #
3. 93
4. DONE

Option 94: DTIM Reports Phone 2*(Default = off)*

The setting for this option determines what events the DTIM reports on phone 2 (Option 05).

Note

See *Option 13: Phone 2 Reports*, for more information on Phone 2 reporting formats.

- Off = no reports
- 0 = all events SIA format
- 1 = all events CID format
- 2 = alarms and manual phone test SIA format
- 3 = alarms and manual phone test CID format
- 4 = non alarms only SIA format
- 5 = non alarms only CID format
- 6 = backup channel SIA format
- 7 = backup channel CID format

➤ **To set DTIM Reports Phone 2, press:**

1. Add
2. Option #
3. 94
4. Use the numbered keys to enter 0 - 7.
5. DONE

➤ **To turn off DTIM Reports Phone 2 (return to default), press:**

1. Delete
2. Option #
3. 94
4. DONE

Option 95: Not Available

Option 96: HWIN2 Output Function*(Default = 1)*

The setting for this option determines how the HWIN2 output will function.

- Off = no output
- 1 = exterior siren output
- 2 = output activated when armed
- 3 = output activated when disarmed
- 4 = fail to communicate output; activates when fail to communicate condition occurs (Option 26 must be on)
- 5 = alarm output activated when panel is in alarm

➤ **To set HWIN2 Output Function, press:**

1. Add
2. Option #
3. 96
4. Use the numbered keys to enter 1 - 5.
5. DONE

➤ **To turn off HWIN2 Output Function, press:**

1. Delete
2. Option #
3. 96
4. DONE

Note

When hardwired sensors are on HWIN2, this option should be set to Off.

Option 97: HWIN1 Output Function*(Default = 1)*

The setting for this option determines how the HWIN1 output will function.

- Off = no output
- 1 = interior siren output
- 2 = output activated when armed
- 3 = output activated when disarmed
- 4 = fail to communicate output; activates when fail to communicate condition occurs (Option 26 must be on)
- 5 = alarm output activated when panel is in alarm

➤ **To set HWIN1 Output Function, press:**

1. Add
2. Option #
3. 97
4. Use the numbered keys to enter 1 - 5.
5. DONE

➤ **To turn off HWIN1 Output Function, press:**

1. Delete
2. Option #
3. 97
4. DONE

Note

When hardwired sensors are on HWIN1, this option should be set to Off.

Programming System Access Codes

Utility Access Code 1 (Dealer Code)

Depending upon how Option 54 is set, the default utility access code is 654321, 54321, 4321 (factory default), or 321. This code can be used for all programming.

Utility Access Code 2 (Installer Code)

Depending upon how Option 54 is set, the default access code is 654321, 54321, 4321 (factory default), or 321. This code is limited to changing all but the following: Utility Access Code 1, Options 4, 5, 6, 8, 9, 12, 13, 54, 56 and 69.

Utility Access Code 3 (For Future Use)

Master Access Code

Depending upon how Option 54 is set, the default Master Access Code is 123456, 12345, 1234 (factory default), or 123. This code is used to: disarm the panel, subdisarm the panel, program light control, set the system clock, program the master code, program access codes 1-5, program the panic code, perform a sensor or phone test, and program options 1, 2, 3, 31, 36, 37, 41, 42, 43, 55, 81 and 82.

Access Codes (1 - 5)

The panel can have up to 5 secondary user access codes. These could be used by children, a baby sitter, or a service person to disarm (or arm if Option 60 is on). These codes cannot be used for programming.

Panic Code

The Panic Code is able to arm, disarm, or subdisarm the panel and send a silent alarm to the Central Station. There will be no indication of an alarm at the panel.

Note

Because different codes can be entered using the same button presses you have to use caution when programming the panic code. You need to ensure that the panic code does not use the same button presses as other access codes. For example if the master code is 1234, do not program the panic code to be 2244. The panel would interpret these codes to be the same code.

➤ To add a code:

1. Press **Add**.
2. Press **Access Code** button. Continue pressing this button until you hear the access code to be changed.
3. Press **DONE**.
4. Enter the new access code by using the numbered keys. The panel announces the new code.

➤ To delete a code:

1. Press **Delete**.
2. Press **Access Code**. Continue pressing this button until you hear the access code to be deleted.
3. Press **DONE**. The panel announces the code is deleted.

Testing the System

This section describes how to perform the following test procedures:

- Control Panel
- Testing sensors
- Testing phone communication
- Testing central station communications
- Testing the X10 Lamp Modules

You should test the system after installing, after servicing, and after adding or removing devices from the system.

Control Panel

Test the Control Panel by pressing the buttons as described below.

- **ARM Doors & Windows**-The panel arms Doors & Windows. Press twice to eliminate the programmed entry delay. The button will blink when No Entry Delay is on.
- **ARM Motion Sensors**-The panel will arm Motion Sensors. Press twice to turn Latchkey on. The button blinks when Latchkey is on.
- **DISARM** -The panel will prompt you to enter an access code. Enter the appropriate code and the panel will disarm Doors, Windows, and Motion Sensors.

Note

An access code is required when arming if Option 60: Secure Arming is on.

Important !

40 keypresses for invalid codes (i.e. 10 invalid 4-digit codes) will cause a system access alarm. The alarm locks all touchpads, except keychains, for 90 seconds.

Arming Levels

Arming Level	Description of Level
0	Sub-disarms (Master Access and Panic codes only), and bypasses 24 hour intrusion sensors (Master Access Code only). Fire sensors (group 26) cannot be sub-disarmed.

Arming Levels

Arming Level	Description of Level
1	Disarm the system
2	Arm Doors and Windows
3	Arm Motions
4	Arm Doors, Windows, and Motions

No beeps verify sub-disarms (LED blinks).

One beep indicates the system is disarmed

Two beeps verify that Door/Window sensors are armed.

Three beeps verify that Motion Sensors are armed.

Four beeps verify that both Door/Window and Motion sensors are armed.

- **SYSTEM STATUS**-Press to determine system status and system time.
- **CHIME Doors**-Press to enable two beeps that sound from interior sirens, panel siren, and the X10 powerhorn siren (if set to unit number 9) when a protected door or window learned into sensor group 10 or 13 is opened. If Option 41: Chime Voice is on, the panel speaker also announces the sensor name and number.
- **CHIME Special Motion**- Press to enable three beeps that sound from interior sirens, panel siren, and the X10 powerhorn siren (if set to unit number 9) when a Motion Sensor that is programmed as sensor type 25 is activated. If there are no sensors learned into sensor group 25, this function will not be available. If Option 41: Chime Voice is on, the panel speaker also announces the sensor name and number.
- **LIGHTS Time Activated**-Press to enable system controlled lights to turn on/off at a scheduled time.
- **LIGHTS Sensor Activated**-Press to enable system controlled lights to turn on for 4 minutes when a specific sensor is tripped.
- **AUX, POLICE, FIRE**-Press and hold or press twice quickly to activate a non-medical, police, or fire emergency alarm

Sensor Testing

We recommend that you test the sensors after all programming is completed and whenever a sensor-related problem occurs.

1. Place all sensors in their secured (non-alarm) state.
2. Open the panel cover.
3. Enter the appropriate access code.
4. Press **Test**.

The panel responds with *Sensor test, press again to change or DONE to select.*

5. Press **DONE**.

The panel will prompt you to trip each sensor one at a time. You may follow the panel voice prompting or test the sensors in any order. Use the "Sensor Tripping Instructions" table to trip sensors.

Sensor Tripping Instructions

Sensor	Do This
Door/Window	Open the secured door or window.
Freeze	Remove sensor cover. Apply ice in a plastic bag to the sensor (for 10-15 minutes). Do not allow the sensor to get wet.

Note

While the sensor test is a valuable installation and service tool, it only tests sensor operation for the current conditions. You should perform a sensor test after any change in environment, equipment, or programming.

Sensor Tripping Instructions

Sensor	Do This
Water	Press a wet rag or wet finger over both of the round, gold-plated terminals on the underside of the detector.
Carbon Monoxide Alarm	Unplug the CO Alarm. Plug it back in, wait 5 seconds, then press the TEST/RESET button until the unit beeps 8 times.
Glass Guard	Tap the glass 3 or 4 inches (8 cm) from the sensor.
Motion Sensor	Avoid the Motion Sensor field of view for 5 minutes, then enter its view.
Rate-of-Rise Heat Detector	Rub your hands together until warm, then place one hand on the detector for 30 seconds.
Shock	Tap the glass twice, away from the sensor. Wait at least 30 seconds before testing again.
Smoke	Press and hold the test button until the system sounds transmission beeps.
Personal Help Button	Press and hold the help button until the light blinks and the panel sounds at least 7 beeps.
KeyChain Touchpad	Press and hold LOCK and UNLOCK simultaneously for 3 seconds.
Remote Handheld Touchpad / QS1500 Keypad	Press and hold the 2 EMERGENCY buttons simultaneously for 3 seconds.
RF Electronic Thermostat / DTIM	Automatically tested when sensor test begins.

6. Interior sirens and speakers sound transmission beeps and a voice announcement identifies the tripped sensor. Each beep represents one RF packet. **Count the number of beeps** and refer to the “Minimum Beeps” table for minimum requirements. After the beeps, the panel announces, *Sensor Name is activated, sensor status is XX* (XX = number of RF packets). The system will continue to prompt for sensors that have not yet been tested. When all sensors have been tested the panel will announce, *Sensor test complete, press DONE*.

Note

If a sensor does not meet the minimum transmission beep requirements, refer to the “If a Sensor Fails the Sensor Test” section of this manual

Minimum Beeps

Type of Sensor	Number of Beeps
Wireless Intrusion Sensors	7–8
Wireless Smoke & Heat Sensors	7–8
Wireless Environmental/Personal Help Buttons	7–8
Hardwire Loops, RF Thermostat, DTIM	1
Emergency Buttons (Remote Handheld Touchpads only)	7-8

7. Press **DONE**. The panel announces, *Sensor Test OK*.
8. If **Cancel** or **DONE** is pressed and the panel has not heard from all sensors, the panel will respond, *Sensor test canceled or failure*.

Improving Sensor/Panel Communication

Antenna

The panel antenna can be put into the wall to increase the panel RF range.



Do not do this for installations that require antenna tamper for external antennas.

Caution

If a Sensor Fails the Sensor Test

If sirens do not beep when a sensor is tripped, use an RF Sniffer (60-401) test tool to verify that the sensor is transmitting. Constant beeps from the RF Sniffer indicate a runaway (faulty) sensor. Replace the sensor.

If possible, locate sensors within 100 feet (30 meters) of the panel. While a sensor may have a range of 500 feet (152 meters) or more out in the open, the environment at the installation site can have a significant effect on transmitter range. A change in sensor location may help overcome adverse wireless conditions and can be accomplished by the following:

- reposition the sensor
- relocate the sensor
- if necessary, replace the sensor

➤ To reposition a sensor

1. Rotate the sensor and test for improved sensor communication at 90 and 180 degrees from the original position.
2. If poor communication persists, relocate the sensor.

➤ To relocate a sensor

1. Test the sensor a few inches from the original position.
2. Increase the distance from the original position and retest until an acceptable location is found.
3. Mount the sensor in the new location.
4. If no location is acceptable, replace the sensor.

➤ To replace a sensor

1. Test a known good sensor at the same location.
2. If the transmission beeps remain below the minimum level, avoid mounting a sensor at that location.
3. If the known-good sensor functions, contact GE Security for repair or replacement of the problem sensor.

Phone Communication

Perform a phone test to check the phone communication between the panel and the central station.

➤ * To perform a phone test or Downloader (DL) phone test

1. Open the panel cover.
2. Enter the appropriate access code.
3. Press **Test** twice to perform a phone test

OR

Press **Test** three times to perform a DL phone test.

4. Press **DONE**. The panel confirms that a phone test or downloader phone test has begun. When the phone test is complete, the panel will announce *Phone Test is*

OK within 3 minutes. The panel will say *Phone test is on* three times if you have a pager. Your pager will display 101 101 if the phone test to the pager was successful.

If the test is unsuccessful, the **SYSTEM STATUS** button will light and the panel will say *Phone communication failure* within 10 minutes.

If the panel announces *Phone communication failure*, proceed to the following instructions.

➤ **If the phone test fails**

1. Check that the panel is connected to the phone jack.
2. Check the phone number programmed into the panel.
3. Perform the phone test again.
4. If the phone test fails again, check the phone connection wiring.

* *Not investigated for use by UL.*

Off-Site Phone Operation

Test the system from a remote phone by calling the panel and using the commands in the following table.

Remote Phone Operation

System Function	Phone Command
DISARM	* + CODE + 1
ARM Doors/Windows	* + CODE + 2
ARM Motion Sensors	* + CODE + 3
ARM Doors/Windows with No Entry Delay	* + CODE + 2 + 2
ARM Motion Sensors with Latchkey	* + CODE + 3 + 3
ARM Doors/Windows and Motion Sensors	* + CODE + 2 + 3
ARM Doors/Windows with No Entry Delay and Motion Sensors with Latchkey	* + CODE + 2 + 2 + 3 + 3
Toggle Lights	* + CODE + 0
System Status	* + CODE + # + 1
Audio Verification	* + CODE + 5 + X (X = a command from Audio Verification Set)
Terminate Session	* + CODE + 9

Central Station Communication

After performing sensor and phone tests, check that the system is reporting alarms successfully to the central station.

➤ **To test communication with the central station:**

1. Call the central station and tell the operator that you will be testing the system.
2. Arm the system.
3. Test each of the wireless panic buttons and trip at least one sensor of each type (fire, intrusion, etc.) to verify that the appropriate alarms are working correctly.

- When you finish testing the system, call the central station to verify that the alarms were received.

Sensor/User Reporting Codes

Arm or Disarm from:	Reports as User:
Panel, Remote Handheld Touchpad or QS1500 Keypad	0
Keychain Touchpad	1-24 (sensor number)
Panel Aux Panic	25
Panel Tamper	26
Panel Police Panic	27
Panel Fire Panic	28
Utility Access Code 1	28
Utility Access Code 2	29
Master Code	30
Access Codes 1-5	31-35
Panic Code	36

Dialog Telephone Interface Module (DTIM)

The following describes the basic steps for testing transmitting range from the DTIM to the panel. For complete testing instructions, see the *DTIM installation instructions*.

- Place the DTIM in the desired location, between 10 and 100 feet (3 and 30 meters) from the panel.
- Put the panel into sensor test mode (See “Sensor Testing”). The panel should sound 1 beep. This indicates good reception from the DTIM to the panel.

Note

If you don't hear a beep, test the DTIM in different locations. Mounting locations should be limited to areas where the panel responds with a beep. Also, you may not get any beeps if a neighboring Simon panel is in a downloading session with ToolBox®.

- To retest transmitting range after relocating the DTIM (or after a neighboring system is finished downloading), you must exit and re-enter sensor test mode.
- Exit from test mode after determining acceptable locations.

Pager Communication

Use the following table to determine what the numeric message is reporting.

Pager Reporting Message

Reports	Numeric Message
Phone Test	-101 -101
AC Power Restoral	-102 -102
AC Power Failure	-103 -103
Latchkey	-104 -104
No Activity	-105 -105
Panic Code	-106 -106

Pager Reporting Message

Reports	Numeric Message
Emergency	-107 -107
Intrusion	-108 -108
Fire	-109 -109
Openings	-110 -110
Closings	-111 -111
Fail to Open	-112 -112
Fail to Close	-113 -113
Bypass	-114-114
Restoral	-115-115
Supervisory	-116-116
Trouble	-117-117
Tamper	-118-118
Gas	-119-119
Freeze	-120-120
Environmental	-121-121
Programing/Sensor Test	-122-122

Note

Panel voice announcements are silenced during AVM sessions. If the operator does not terminate the session correctly, panel announcements may not occur for up to 90 seconds after the operator hangs up.

Note

To conduct an audio session using remote phone access see the Table "Phone Commands for Remote Access" in the "Testing" section.

2-Way Voice Operation

To initiate an audio session, the central station operator must perform the following steps:

1. After the panel has completed reporting the alarm, pick up the CS phone and press the  button to start the audio session.
2. Press 1 or 0 to speak, 2 for VOX operation, and 3 or 6 to listen.
3. Press 99 to terminate the session.

Audio Verification Set

Phone Button(s)	Function
0-1	Speak
2	VOX operation
3 or 6	Listen
7	Extend session for 90 more seconds
88	Terminates session with call back (the panel answers on the first ring if called within 5 minutes)
99	Terminates session with no call back

Voice Event Notification

Testing this feature requires two people; one at the alarm site and the other at the location the panel is programmed to call (Options 5 and/or 43). The panel only reports alarms and Latchkey when this feature is set up.



If the system is monitored by a central station, contact them first before setting off any alarms to avoid a false dispatch.

Caution

1. Contact the central monitoring station (if system is monitored) to inform them you are testing the system and not to dispatch authorities.
2. At the system site, put the system into an alarm condition.
3. At the calling location, pick up the phone after it starts ringing. You should hear the panel voice announce "Press star for alarm."
4. Press * and the panel voice identifies the alarm. If there is more than one alarm in progress, the user must press * for the panel voice to identify them.
5. After all alarms have been identified, the panel announces "Press # to exit."
6. Press # to terminate the call.

Important !

You must terminate the call by pressing #. Otherwise, the panel may not disconnect from the phone line for up to 2 minutes.

RF Thermostat Operation

The following information is important for the RF Thermostat to function through your control panel:

- The panel needs to be armed to Level 4 (Doors & Windows and Motion Sensors) for Energy Saving Mode to work.
- If there are no Motion Sensors in the system, the Motion Sensors button must still be pressed (armed to level 4).
- Both options can be turned on at the same time.
- Thermostat has to be in Auto Mode for Options 81 and 82 to work correctly.
- If Options 81 and 82 are programmed, the RF Thermostat will go from Energy Saving Mode to normal operating mode when the panel is armed to level 2.

Personal Help Button

The following information is important for the Personal Help Button to function through your control panel:

- Test the help button from several locations within the premises to check for a consistent response.
- Instruct the user to test the help button weekly
- Decide how the user wants to access the help button (wall mount, belt clip, wrist band or necklace)

For more information on the Personal Help Button refer to the *Water Resistant Personal Help Button Installation Instructions (466-1815)*.

X10 Operation

The following sections describe how to test X10 Lamp, Siren, Appliance, and Universal Module operation.

Manual Lamp Module Control

- **Control Panel:** Press the Lights On button and the unit # of the lamp module using the numeric buttons to test individual lamp modules 2, 4, 6, and 8. The panel responds with *Lights # on/off*. Press the Lights On button twice to turn on all lamp modules. Press the Lights Off button twice to turn off all lamp modules.

- **Keychain Touchpad:** Press the **LIGHT** button repeatedly to turn all lights on and off. The panel responds with *Lights on/off*.
- **Remote Handheld Touchpad/QS1500 Keypad:** Press the **Lights On** button and the **unit #** of the lamp module using the numeric buttons to test individual lamp modules 1 - 8. The panel responds with *Lights # on/off*. Pressing the **Lights On** or **Off** button twice, turns all the lights on or off.

X10 Siren and Lamp Module Functions

All sirens turn off when the system is disarmed or when the siren timeout expires. Siren priority is as follows:

1. Fire (highest priority)
2. Intrusion
3. Emergency

If an alarm of greater priority occurs during an alarm of lower priority, the greater priority alarm sirens sound. Fire alarms sound a temporal 3 pattern (0.5 seconds on, 0.5 seconds off for three beeps then 1.5 seconds off).

Note

The X10 Siren must be set to unit #9 to “hear” emergency alarms and Status Beeps. To “hear” emergency alarms only, set to unit #10.

Alarm Siren and X10 Light Information

	Fire	Intrusion	Emergency
X10 Lights	Steady	Flashing	Steady
X10 Siren	Steady	Steady	Alarm beeps
Interior & Panel Siren	Temporal 3	Steady	Fast on/off
Exterior Siren	Temporal 3	Steady	

Emergency Planning

Emergency Planning Floor Plan

Use these guidelines when drawing an emergency floor plan for the homeowner:

- Show all building levels.
- Show exits from each room (2 exits per room are recommended).
- Show the locations of all security system components.
- Show the locations of any fire extinguishers.

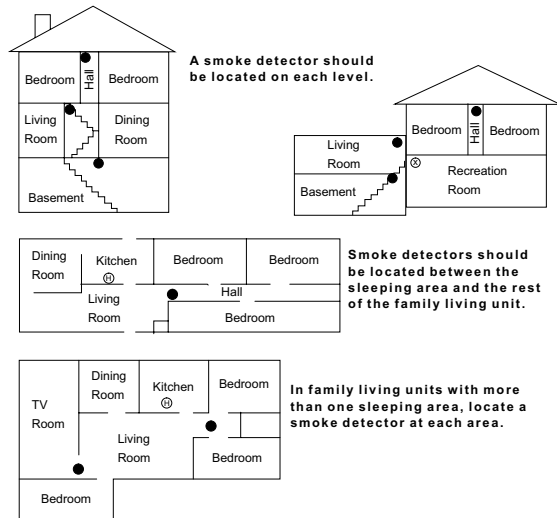

A smoke detector should be located on each level.

Smoke detectors should be located between the sleeping area and the rest of the family living unit.

In family living units with more than one sleeping area, locate a smoke detector at each area.

NOTE: Ceiling-mounted smoke detectors should be located in the center of the room or hall, or not less than 4 inches from the wall. When the detector is mounted on the wall, the top of the detector should be 4 to 12 inches from the ceiling.

NOTE: Do not install smoke detectors where normal ambient temperatures are above 100°F or below 40°F. Also, do not locate detectors in front of AC/ Heat registers or other locations where normal air circulation will keep smoke from entering the detector.

NOTE: Additional information on household fire warning is available at nominal cost from: The National Fire Protection Association, Batterymarch Park, Quincy, MA 02269. Request Standard No. NFPA74.

- Required smoke detector
- ⊕ Heat detector
- ⊗ Indicates smoke detector is optional if door is not provided between basement and recreation rooms.

Figure 13. Diagram of Smoke Detector Locations

System Status

How to clear SYSTEM STATUS (Alarm Memory)

From a disarmed state press SYSTEM STATUS, listen to the status message, then press DISARM.

Panel announces *Siren 1 failure or Siren 2 failure*.

- Turn option 53 off if a hardwire siren or sensor is not connected.
- Check for the correct end-of-line resistor in HWIN 1 and 2 circuits.

Panel announces *Low Battery*.

- Check that panel backup battery is connected.
- Check panel backup battery voltage. If less than 5.4 volts, replace battery, clear system status message and run a sensor test.
- If AC power has been off for an extended period, the backup battery could still be charging.

Panel announces *RF Failure*. Touchpads announce *Option 50 Detected*.

- Option 50 is RF jam detect. The control panel has detected RF interference.

Panel announces that a sensor is open.

- See Sensors section below.

Panel announces *System time is not set*.

- Set the system time.

Control Panel

Panel announces *Function not available* when Chime Doors is pressed.

- No sensors are programmed using sensor type 10 or 13.

Panel announces *Function not available* when Chime Special Motion is pressed.

- No sensors are programmed using sensor type 25.

Panel announces *Function not available* when LIGHTS Time Activated is pressed.

- No time activated lights have been programmed.

Panel announces *Function not available* when LIGHTS Sensor Activated is pressed.

- No sensor activated lights have been programmed.

Panel announces *Invalid. Sensor already programmed as Sensor Name*.

- This sensor is already programmed. Delete sensor if not correctly programmed.

Options (Programmable by the homeowner)

Panel does not beep.

- Turn on (add) Option 1.

Latchkey does not function.

- Latchkey time (option 3) is not set. Set Latchkey time.
- Latchkey is not enabled. Enable Latchkey by pressing ARM Motion Sensors twice.
- The phone number is not programmed properly. Reprogram the phone number. (options 13 or 43)
- System Time is not set. Set system time.

Sensors

A sensor does not work.

- Make sure the battery is good and installed correctly.
- Check for interference from metal objects. Move or rotate the sensor.
- Move the sensor to a new location.

Door or window is closed, but the panel announces it is open.

- Be certain the arrow on the magnet and the guide line on the transmitter are aligned and within 1/4 inch of each other.
- The sensor tamper switch may be open (cover off).

Motion sensors go off continuously.

- Be sure the sensor is mounted on a solid surface and the viewing field is free from sources of changing temperature.

Motion sensor does not respond to motion.

- Make sure the sensor battery is good and installed correctly. Wait 2 minutes after installing a new battery to test the sensor.
- Adjust the sensor mounting.
- Leave the area for 3 minutes, then retest.
- The environment is too hot or too cold. Outdoor sensors will operate between 32° and 120°F (0° and 49°C).
- Dirt or dust may be causing the problem. Wipe the sensor with a clean, damp cloth.

X10 Modules

All Lamp Modules or Siren not working.

- Be sure the panel transformer is plugged into an outlet that is not controlled by a switch.
- Check that the panel is powered using the line carrier power transformer.
- House code was programmed incorrectly.

One Lamp Module or Siren is not working.

- Unplug nearby equipment that may be causing interference (light dimmer switches, televisions, appliances with older motors).
- Check that the switch on the lamp or appliance is turned on and remains on.
- Make sure the lamp has a working bulb.
- Make sure the lamp or appliance is plugged into the Lamp/Appliance Module, the Module is plugged into the outlet and the outlet is not controlled by a switch.
- Make sure the House and Unit Codes are correct.
- Move the Module to a different outlet that is on the same phase (branch) of the household electrical circuit as the panel.

Time or sensor activated light not working.

- Make sure you have programmed the light to be activated by a timer or sensor.
- Make sure the system clock is set.
- Make sure these functions have been enabled by pressing the LIGHTS Time Activated/Sensor Activated button on the panel. The functions are enabled if the button is lit.

**Appendix B:
System
Configuration**

Sensor Assignments/Locations

Sensor No.	Device	Sensor Group	Sensor Name/Location	Notes
01				
02				
03				
04				
05				
06				
07				
08				
09				
10				
11				
12				
13				
14				
15				
16				
17				
18				
19				
20				
21				
22				
23				
24				

Alphabetical Listing of Sensor Names

Attic, Back Door, Back Window, Basement, Basement Window, Bathroom, Bathroom Window, Bedroom, Bedroom Window, Child's Room, Child's Room Window, Closet, Den, Den Window, Dining Room, Dining Room Window, Downstairs, Downstairs Window, Front Door, Front Window, Garage, Garage Door, Garage Window, Guest Room, Guest Room Window, Hallway, Keychain Remote, Kitchen, Kitchen Window, Laundry Room, Laundry Room Window, Living Room, Living Room Window, Master Bedroom, Master Bedroom Window, Medicine Cabinet, Module, Office, Office Window, Patio Door, Phone Communication Module, Porch, Porch Window, Special Chime, System Panic, Touchpad Remote, Upstairs, Upstairs Window, Utility Room

Sensor Group Characteristics

Type	Name/Application	Siren Type	Delay	Restoral	Supervisory	Active in Levels
00	Fixed Panic: 24 hour audible fixed emergency button	Intrusion	I	No	Yes	1234
01	Portable Panic: 24 hour audible portable emergency buttons	Intrusion	I	No	No	1234
02	Fixed Panic: 24 hour silent fixed emergency buttons. Status light will not blink.	Silent	I	No	Yes	01234
03	Portable Panic: 24 hour silent portable emergency buttons. Status light will not blink.	Silent	I	No	No	01234
04	Fixed Auxiliary: 24 hour auxiliary sensor	Emergency	I	No	Yes	01234
05	Fixed Auxiliary: 24 hour emergency button. Siren shut off confirms CS report	Emergency	I	No	Yes	01234
06	Portable Auxiliary: 24 hour portable auxiliary alert button	Emergency	I	No	No	01234
07	Portable Auxiliary: 24 hour portable auxiliary button. Siren shut off confirms CS report	Emergency	I	No	No	01234
08	Special Intrusion: such as gun cabinets and wall safes. DTIM (tamper only)	Intrusion	I	Yes	Yes	1234
09	Special Intrusion: such as gun cabinets and wall safes.	Intrusion	S	Yes	Yes	1234
10	Entry/Exit Delay: Entry/Exit Delay that require a standard delay time. Chime	Intrusion	S	Yes	Yes	24
13	Instant perimeter: Exterior doors and windows. Chime.	Intrusion	I	Yes	Yes	24
14	Instant Interior: Interior doors	Intrusion	F	Yes	Yes	234
15	Instant Interior: Interior PIR motion sensors*	Intrusion	F	No	Yes	234
16	Instant Interior: Interior doors	Intrusion	F	Yes	Yes	34
17	Instant Interior: PIR motion sensors and Sound sensors*	Intrusion	F	No	Yes	34
18	Instant Interior Cross-Zone# PIR motion sensors*	Intrusion	F	No	Yes	34
19	Delayed Interior: interior doors that initiate a delay before going into alarm*	Intrusion	S	Yes	Yes	34
20	Delayed Interior: PIR motion sensors that initiate a delay before going into alarm*	Intrusion	S	No	Yes	34
21	Local Instant Interior: 24 hour local alarm zone protecting anything that opens and closes. No Reports	Intrusion	I	Yes	Yes	1234
22	Local delayed interior: same as group 21, plus activation initiates a delay before going into alarm. No reports.*	Intrusion	S	Yes	Yes	1234
23	Local instant Auxiliary: 24 hour local alarm zone protecting anything that opens and closes.‡ No reports	Emergency	I	Yes	Yes	01234
24	Local Instant Auxiliary: 24 hour local alarm zone protecting anything that opens and closes. Sirens shut off at restoral. No reports.*	Emergency	I	Yes	Yes	01234
25	Local Special Chime: Notify the user when a door is opened. Sounds emit from a local annunciator.* Direct Bypass and Unbypass when no Special Motion Chime sensors are in the security system. No reports	Three Beeps	I	No	Yes	01234
26	Fire: 24 hour fire, rate-of-rise heat, and smoke sensors§.	Fire	I	Yes	Yes	01234
27	Lamp control or other customer feature.‡ No reports	Silent	I	Yes	Yes	01234

* This type is not certified as a primary protection circuit for UL-listed systems and is for supplementary use only.

§ This type is required for UL-listed residential fire alarm applications.

‡ This type has not been investigated by UL.

See "Cross Zoning" section on page 72

Delays:

I = Instant Delay (no delay, immediate alarm)

S = Standard Delay (alarm sounds after programmed entry delay time)

F = Follower Delay (alarm sounds immediately if entry/exit delay is not active, otherwise alarm sounds after programmed entry delay time)

Sensor Group Characteristics

Type	Name/Application	Siren Type	Delay	Restoral	Supervisory	Active in Levels
28	PIR motion sensor, sound sensor or pressure mat.‡ No reports	Silent	I	No	Yes	01234
29	Auxiliary: Freeze Sensors	Trouble Beeps	I	Yes	Yes	01234
32	PIR motion sensor or sound sensor‡ No reports	Silent	I	No	No	01234
34	Carbon Monoxide Alarm	Emergency	I	Yes	Yes	01234
35	Entry/Exit Delay Interior PIR Motion	Intrusion	S	No	Yes	234
36	Special Intrusion: such as gun cabinets and wall safes. Reports as tamper if tripped. RF Thermostat. DTIM (tamper only).	Intrusion	I	Yes	Yes	1234
37	Light Switch Control: X10 Modules turn either on or off when a door is opened. No reports.	Silent	I	No	Yes	01234
38	Auxiliary: Water Sensors.	Trouble Beeps	I	Yes	Yes	01234

* This type is not certified as a primary protection circuit for UL-listed systems and is for supplementary use only.

§ This type is required for UL-listed residential fire alarm applications.

‡ This type has not been investigated by UL.

See "Cross Zoning" section on page 72

Delays:

I = Instant Delay (no delay, immediate alarm)

S = Standard Delay (alarm sounds after programmed entry delay time)

F = Follower Delay (alarm sounds immediately if entry/exit delay is not active, otherwise alarm sounds after programmed entry delay time)

Cross-Zoning

Note

Cross-Zoning is not recommended for exit/entry zones. Each zone has the ability to individually protect the intended area. (e.g. motion detector patterns overlap).

Cross-Zone (Two-Trip) refers to two different Group 18 sensors that must be tripped within two minutes of each other to report an alarm to the central station. The diagram in Figure 14 shows the path of a person walking from the kitchen to the living room. When the person is detected walking through the kitchen, the motion sensor in the kitchen is tripped, sounding a local alarm. If motion is detected by the living room motion sensor within two minutes, an alarm report will be sent to the central station.

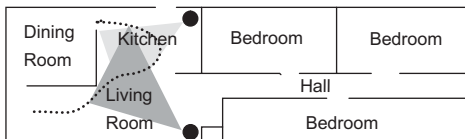

- ▼ Detection Path/Kitchen Motion Sensor
- ▲ Detection Path/Living Room Motion Sensor
- Motion Sensor
- Path of Person Walking

Figure 14. Cross-Zone Diagram

Home Control Planning Table

Module			Activated by		Time Activated	
Unit #	Type	Location	Sensor	Entry/Exit	Start Time	Stop Time
Example	Lamp	Hall lamp	Motion	Yes	8 p.m.	10:30 p.m.
1						
2						
3						
4						
5						
6						
7						
8						

System Access Codes

The factory default settings are 4-digit access codes, but the default codes will change whenever Option 54 (Access Code Length) is reset. The default for each access code length is listed.

System Access Codes

Type	Default	Installer Settings
Utility Access Code 1	654321, 54321, 4321, or 321	
Utility Access Code 2	654321, 54321, 4321, or 321	
Master Access Code	123456, 12345, 1234, or 123	
Access Code 1	None	
Access Code 2	None	
Access Code 3	None	
Access Code 4	None	
Access Code 5	None	
Panic Code	None	

Option Settings

Opt. #	Function	Default	Delete	Range	Who Can Change:	Installer Settings
01	Panel Piezo Beeps (must be on for UL listed systems)	On	Off	On/Off	U1 U2 M	
02	Panel Voice	On	Off	On/Off	U1 U2 M	
03	Latchkey Option	Off	Off	12:00 Midnight - 11:59 PM	U1 U2 M	
04	Primary Phone Number	Off	Off	26 digits	U1	
05	Secondary Phone Number	Off	Off	26 digits	U1	

Opt. #	Function	Default	Delete	Range	Who Can Change:	Installer Settings
06	Downloader Phone Number	Off	Off	26 digits	U1	
07	Account Number	00000	00000	0 - FFFFFFFF	U1 U2	
08	Phone Lock	Off	Off	On/Off	U1	
09	Downloader Code	12345	12345	00000-99999	U1	
10	Entry Delay (must be 45 seconds or less for UL listed systems)	030 sec	005 sec	005-254 sec 030-254 if Option 69 is added	U1 U2	
11	Exit Delay (must be 60 seconds or less for UL listed systems)	060 sec	005 sec	005-254 sec 045-254 if Option 69 is added	U1 U2	
12	Phone 1 Reports (must be 00 or 01 for UL listed systems)	00	Off	00-10	U1	
13	Phone 2 Reports	Off	Off	00-10	U1	
14	DTMF	On	Pulse	On/Off	U1 U2	
15	No Activity Report	Off	Off	02-24 hrs	U1 U2	
16	Auto Phone Test (must be set to 001 for UL listed systems)	Off	Off	001-254 days	U1 U2	
17	Dialer Delay	030	Off	005-254 sec 015-045 is Option 69 is added	U1 U2	
18	Alarm Cancel	006	Off	006-255 min	U1 U2	
19	RF Timeout (SUPSYNC) (must be set to less than 04 for UL 985 & 1635 Listed systems, or less than 24 for UL 1023 Listed systems)	12 hrs	12 hrs	02-36 hrs	U1 U2	
20	Manual Phone Test	On	Off	On/Off	U1 U2	
21	Opening Reports	Off	Off	On/Off	U1 U2	
22	Closing Reports	Off	Off	On/Off	U1 U2	
23	Force Armed Report	Off	Off	On/Off	U1 U2	
24	AC Power Failure Report (must be added for UL listed systems)	Off	Off	005-254 min	U1 U2	
25	CPU Low Battery Report (must be added for UL listed systems)	On	Off	On/Off	U1 U2	
26	Fail to Communicate (must be added for UL listed systems)	On	Off	On/Off	U1 U2	
27	Ring/Hang/Ring	1	Off	1-7	U1 U2	
28	No Delay from Key Chain Touchpad	Off	Off	On/Off	U1 U2	
29	Panel Piezo Alarms (must be added for UL listed systems OR a siren must be connected)	On	Off	On/Off	U1 U2	
30	Panic Alarms	On	Off	On/Off	U1 U2	
31	Downloader Enable	On	Off	On/Off	U1 U2 M	
32	300 Baud Central Station Communications	On	110 Baud	On/Off	U1 U2	
33	Audio Verification	Off	Off	On/Off	U1 U2	
34	Fail to Open	Off	Off	12:00 Midnight - 11:59 PM	U1 U2	
35	Fail to Close	Off	Off	12:00 Midnight - 11:59 PM	U1 U2	
36	Sensor Activated Light Lockout Start Time	Off	Off	12:00 Midnight - 11:59 PM	U1 U2 M	

Opt. #	Function	Default	Delete	Range	Who Can Change:	Installer Settings
37	Sensor Activated Light Lockout Stop Time	Off	Off	12:00 Midnight - 11:59 PM	U1 U2 M	
38	Auto Arm (must be added for UL listed systems)	On	Off	On/Off	U1 U2	
39	Siren Time Out (must be greater than 4 minutes for UL listed systems)	004 min	Siren never times out	002 - 254 minutes/ no time out	U1 U2	
40	Trouble Beeps (must be added for UL listed systems)	On	Off	On/Off	U1 U2	
41	Chime Voice	Off	Off	On/Off	U1 U2 M	
42	Speaker Level	8	8	1-8	U1 U2 M	
43	Pager Phone Number	Off	Off	26 digits	U1 U2 M	
44	Pager Phone 3 Reports	Off	Off	08-10	U1 U2	
45	Sensor Alarm Restoral	Off (0)	Off (0)	0 - 3	U1 U2	
46	Fire Shutdown - AVM	Off	Off	On/Off	U1 U2	
47	Audio Verification Mode	Off	Off	On (Callback) Off (Instant)	U1 U2	
48	Panic Talk - AVM	Off	Off	On/Off	U1 U2	
49	Arming LEDs Shutdown	Off	Off	On/Off	U1 U2	
50	RF Jam Detect (must be added for UL listed systems)	Off	Off	On/Off	U1 U2	
51	24 Hour Sensor Tamper	Off	Off	On/Off	U1 U2	
52	Unvacated Premises	On	Off	On/Off	U1 U2	
53	Hardwire Siren Supervision (must be added for UL listed systems if Option 29 is deleted)	Off	Off	On/Off	U1 U2	
54	Access Code Length	4	4	3-6	U1	
55	Status Beep Volume	07	07	01 - 10	U1 U2 M	
56	Call Waiting	Off	Off	1-26 digits/Off	U1 U2	
57	Supervisory Tamper Report	Off	Off	On/Off	U1 U2	
58	Remote Touchpad Arming	Off	Off	On/Off	U1 U2	
59	Exit Extension (must be deleted for UL listed systems)	On	Off	On/Off	U1 U2	
60	Secure Arming	Off	Off	On/Off	U1 U2	
61	Demo Mode	Off	Off	On/Off	U1 U2	
62	Supervisory Protest	Off	Off	On/Off	U1 U2	
63	24 Hour Clock	Off	Off	On/Off	U1 U2	
64	No Arm on Panel Low Battery	Off	Off	On/Off	U1 U2	
65	No Usage Report	Off	Off	1-254/Off	U1 U2	
66	External Siren Delay	Off	Off	On/Off	U1 U2	
67	Quick Exit (must be disabled for UL listed systems)	Off	Off	On/Off	U1 U2	
68	Swinger Shutdown	On	Off	On/Off	U1 U2	
69	SIA Limits	On	Off	On/Off	U1	
70	Not Available					
71	Programming Report	Off	Off	On/Off	U1 U2	
72	Supervisory Time	Midnight	Off	12:00 Midnight - 11:59 PM	U1 U2	

Opt. #	Function	Default	Delete	Range	Who Can Change:	Installer Settings
73	Modem Sensitivity	Off (normal)	Off	On (high)/Off (normal)	U1 U2	
74	Panel Police Panic Audio	Off (audible)	Off	On (silent)/Off (audible)	U1 U2	
75	VOX Mic Gain	14	14	01 - 64	U1 U2	
76	VOX Gain Range	64	64	01 - 64	U1 U2	
77	Manual Mic Gain	64	64	01 - 64	U1 U2	
78	VOX Receiver Gain	06	06	01 - 10	U1 U2	
79	Panel Tamper Alarm	Off	Off	On/Off	U1 U2	
80	Alarm Report Verification	Off	Off	On/Off	U1 U2	
81	Heating Set Point	Off	Off	51°F - 91°F (10°-33°C)	U1 U2	
82	Cooling Set Point	Off	Off	51°F - 91°F (10°-33°C)	U1 U2	
83	X10 RF Light Control	Off	Off	On/Off	U1 U2	
84	European Compliance (for European installations)					
85	Smoke Supervision (must be set to on for UL 985 listed systems)	Off	Off	On/Off	U1 U2	
86	Fire Alarm Verify	Off	Off	On/Off	U1 U2	
87	2-Way RF Touchpad Voice	Off	Off	On/Off	U1 U2	
88	Custom Defaults (for custom installations) Important ! <i>DO NOT attempt to change or program this option without authorization from GE Security. Changing this option could make your panel inoperable.</i>					
89	Serial Port Protocol	Off	Off	On/Off	U1 U2	
90	Comm Channel 1 Reports	Off	Off	0 - 1	U1 U2	
91	Comm Channel 2 Reports	Off	Off	0 - 1	U1 U2	
92	Comm Channel 3 Reports	Off	Off	Off - 0	U1 U2	
93	DTIM Reports Phone 1	Off	Off	0 - 5	U1 U2	
94	DTIM Reports Phone 2	Off	Off	0 - 7	U1 U2	
95	Not Available					
96	HWIN2 Output Function	1	Off	1 - 5	U1 U2	
97	HWIN1 Output Function	1	Off	1 - 5	U1 U2	
<i>U1 = Utility Access Code 1 U2 = Utility Access Code 2 M = Master Access Code</i>						

Appendix C: Software Release Notes

Software Version 4.0

The following features were changed/added for software version 4.0.

Dialog Telephone Interface Module (DTIM)

The DTIM is a battery operated communication link between the security system control panel and the central monitoring station. The DTIM receives radio signals from the panel, then uses the phone line to report security system events to the central station.

Ethernet Interface Module

The Ethernet Interface module is an ethernet module designed to provide an additional reporting method for Simon panels. The module reports events to the premisesconnect.com web site and up to two Osborne Hoffman (OH2000E) network receivers.

Premisesconnect.com is used by:

- Installers - to aid in installation and maintenance of security systems.
- Dealers - to simplify customer and account management.
- First Responders - to identify where and how to respond.
- Customers - to control their security system.

Option Changes

Option 12

Option 12 settings are now off and 00 - 10.

Option 13

Option 13 default changed from 0 to off.

Option 44

Option 44 default changed from 09 to off.

New Options

Option 87 2-Way RF Touchpad Voice

Determines the amount of broadcast speech that is sent to 2-Way RF touchpads (Dialog QS1500 Touchtalk Interactive Keypad).

If this option is on, the panel will send broadcast speech messages to the touchpads for arming, disarming, alarm cancel and dialer abort events.

If this option is off, the panel only sends broadcast speech messages to the touchpads for voice chime events.

Option 88 Custom Defaults

Custom default settings for custom installations

Option 89 Serial Port Protocol

Determines if the Ethernet Interface Module is enabled.

If this option is on, the Ethernet Interface module protocol on the serial port connector is enabled.

If this option is off, the downloader protocol on the serial port connector is enabled.

Option 90 Comm Channel 1 Reports

The setting for this option determines which reports are sent to central station receiver 1 by the Ethernet Interface module.

Option 91 Comm Channel 2 Reports

The setting for this option determines which reports are sent to central station receiver 2 by the Ethernet Interface module.

Option 92 Comm Channel 3 Reports

The setting for this option determines which reports are sent to the premisesconnect.com website by the Ethernet Interface module.

Option 93 DTIM Reports Phone 1

The setting for this option determines what events the DTIM reports on phone 1.

Option 94 DTIM Reports Phone 2

The setting for this option determines what events the DTIM reports on phone 2.

Option 96 HWIN2 Output Function

The setting for this option determines how the HWIN2 output will function.

Option 97 HWIN1 Output Function

The setting for this option determines how the HWIN1 output will function.

Specifications

Power Requirements:9 VAC, 700 mA

Rechargeable Batteries: ..6.0 VDC, 1.2 Ah Lead-Acid. The battery will last 24 hours with no AC and specified standby load

Radio Frequency:319.5 MHz (60-875) 433 MHz (60-910)

Nominal Range:500 feet (152 meters), open-air receiving range



















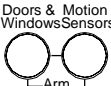



















Storage Temperature Range:-29° to 140° F (-34° to 60° C)

Operating Temperature Range: 32° to 120° F (0° to 49° C)

Maximum Humidity:90% relative humidity, noncondensing

Auxiliary Power:Unregulated 5.1 - 12 VDC, power-limited to 250 mA (maximum) @ 10 VDC

Quick Reference Table

How to ...	Control Panel	Remote Handheld Touchpad	Keychain Touchpad	Remote Phone
Disarm the System (Level 1)	 + Access Code	Disarm  + Access Code	 Press once	Press * + Code + 1
Subdisarm the System (Level 0)	Enter Master Code while system is disarmed	Enter Master Code while system is disarmed		Press * + Master Code + 1
Arm Only - Doors & Windows (Level 2)	 Press once	ARM Doors & Windows  Press once	 Press once	Press * + Code + 2
Arm Only - Motion Sensors (Level 3)	 Press once	ARM Motion Sensors  Press once		Press * + Code + 3
Arm Doors, Windows & Motion Sensors (Level 4) ~	 Press each button once	ARM Doors & Windows  ARM Motion Sensors  Press each button once	 Press twice	Press * + Code + 2 + 3
Activate No Entry Delay	 Press twice	ARM Doors & Windows  Press twice	 Press once (if programmed)	Press * + Code + 2 + 2
Activate Latchkey Feature	 Press twice	ARM Motion Sensors  Press twice	 Press 3 times	Press * + Code + 3 + 3
Activate a Panic Alarm	 Press twice	 Press both Emergency buttons and hold for 3 seconds	 Press both & hold for 3 seconds	
Check the System Status	 Press once	SYSTEM STATUS  Press once		Press * + Code + # + 1
Set Doors or Special Motion to Chime	  Press either Doors or Motion once			
Direct Bypass a Sensor	 Press once to bypass, then code. Press again to unbypass			
Turn Time Activated Lights On/Off	 Press once			
Turn Sensor Activated Lights On/Off	 Press once			
Turn On/Off Special Lights	 OR  Press once + even unit number	 + Unit # OR  + Unit #	 Press once	
Turn All Lights On/Off	 OR  Press twice	 Press twice OR  Press twice	 Press once	Press * + Code + 0

~ Automatically activates Energy Saving Mode for systems with an RF Thermostat