



IFS MC355-1T/1S

Quick Installation Guide

Copyright	© 2012 UTC Fire & Security Company. All rights reserved.
Trademarks and patents	Interlogix, IFS MC355-1T/1S, the IFS Brand and logo are trademarks of UTC Fire & Security. Other trade names used in this document may be trademarks or registered trademarks of the manufacturers or vendors of the respective products.
Manufacturer	UTC Fire & Security Americas Corporation, Inc. 2955 Red Hill Avenue, Costa Mesa, CA 92626-5923, USA
EU	Authorized EU manufacturing representative: UTC Fire & Security B.V. Kelvinstraat 7, 6003 DH Weert, Netherlands
Version	This document applies to IFS MC355-1T/1S version 1.0.
Certification	  
FCC compliance	<p>Class A: This equipment has been tested and found to comply with the limits for a Class A digital device, pursuant to part 15 of the FCC Rules. These limits are designed to provide reasonable protection against harmful interference when the equipment is operated in a commercial environment. This equipment generates, uses, and can radiate radio frequency energy and, if not installed and used in accordance with the instruction manual, may cause harmful interference to radio communications. Operation of this equipment in a residential area is likely to cause harmful interference in which case the user will be required to correct the interference at his own expense.</p>
Canada	<p>This Class A digital apparatus complies with Canadian ICES-003.</p> <p>Cet appareil numérique de la classe A est conforme à la norme NMB-003 du Canada.</p>
ACMA compliance	<p>Notice! This is a Class A product. In a domestic environment this product may cause radio interference in which case the user may be required to take adequate measures.</p>

European Union directives

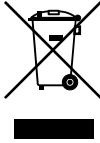

2004/108/EC (EMC directive): Hereby, UTC Fire & Security declares that this device is in compliance with the essential requirements and other relevant provisions of Directive 2004/108/EC

2002/96/EC (WEEE directive): Products marked with this symbol cannot be disposed of as unsorted municipal waste in the European Union. For proper recycling, return this product to your local supplier upon the purchase of equivalent new equipment, or dispose of it at designated collection points. For more information see: www.recyclethis.info.

Contact information

www.utcfireandsecurity.com or www.interlogix.com

Customer support

www.interlogix.com/customer-support

Contents

Package Contents	1
Hardware & Software requirements	1
Wiring the Power Inputs	2
Web Management	3
Logging in to Media Converter	4
Hardware & Password Reset	6
Contacting Technical Support	7

Package Contents

Thank you for purchasing the IFS 10/100/1000-T to mini-GBIC Industrial Managed Media Converter, MC355-1T/1S.

Open the package containing the MC355-1T/1S and carefully unpack it. The box should contain the following items:

- MC355-1T/1S x1
- User's Manual CD x1
- Quick Installation Guide x1
- Wall Mount Kit x 4
- DIN Rail Kit x 1

If any of the items in the package are damaged or missing, please contact your distributor or IFS sales rep. If possible, retain the original carton and packaging material in case of need to return the product for repair/replacement.

Hardware & Software requirements

- Client workstations running Windows 98/ME, NT4.0, 2000/XP, Vista, MAC OS9 or later, Linux, UNIX or other platform compatible with TCP/IP protocols
- Workstation installed with Ethernet NIC (Network Card)
- Ethernet Port connection
- Network cables - Use standard network (UTP) cables with RJ45 connectors
- PC installed with WEB Browser and JAVA runtime environment Plug-in

Note: We recommended using Internet Explore 6.0 or above to access the MC355-1T/1S Industrial Managed Media Converter.

Wiring the Power Inputs

The 6-contact terminal block connector on the top panel of Industrial Managed Media Converter is used for two DC redundant power supply inputs. Please follow the steps below to insert the power wires.

1. Insert the positive / negative DC power wires into the contacts 1 and 2 for POWER 1, or 5 and 6 for POWER 2. Figure 1 shows PWR1 and PWR2 of the Industrial Managed Media Converter.

Figure 1: PWR1 & PWR2 of Industrial Managed Media Converter

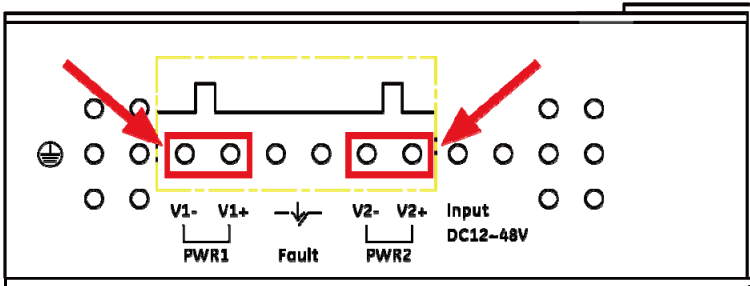

V1- V1+ V2- V2+

2. Tighten the wire-clamp screws to prevent the wires from disconnecting. Figure 2 shows PWR1 and PWR2 pin of the terminal block.

Figure 2: PWR1 & PWR2 of Industrial Managed Media Converter

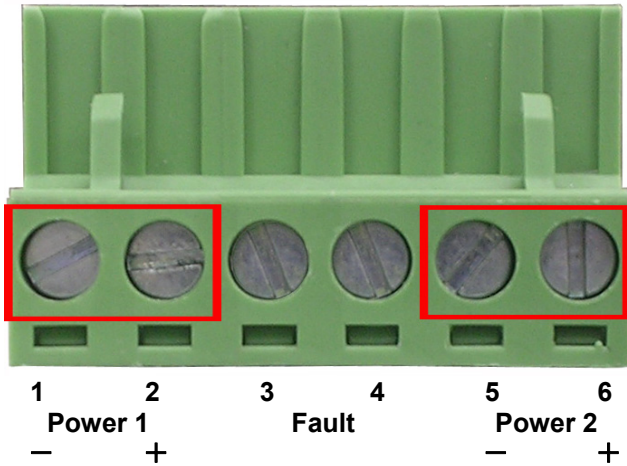

Note: The wire gauge for the terminal block should be in the range between 12 ~ 24 AWG.

Web Management

The MC355-1T/1S has a built-in browser interface. The media converter can be managed remotely by having a remote host with a Web browser, such as Microsoft Internet Explorer, Mozilla Firefox, Google Chrome or Apple Safari.

To be able to login to the media converter, the administrator workstation should be set to the same IP range and subnet mask. Default IP address for media convert is 192.168.0.100, and the default subnet mask is 255.255.255.0. Therefore, the administrator PC should be set to 192.168.0.x (where x is a number between 1 and 254) and subnet mask should be set to 255.255.255.0.

Figure 3: IP Management Diagram

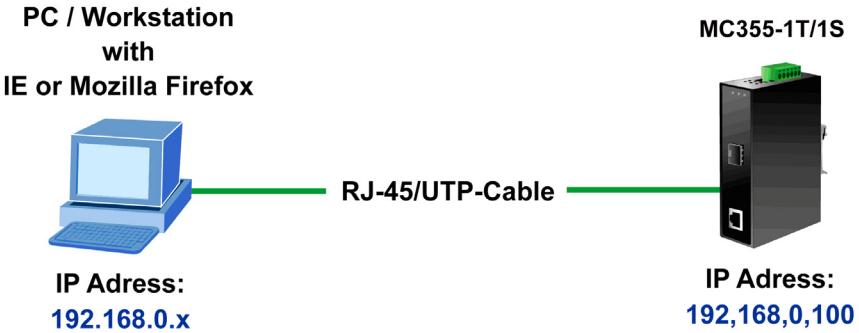

Logging in to Media Converter

1. Open the web browser and enter the default IP address <http://192.168.0.100> to the address bar.
2. Figure 4 illustrates the Web Login screen that will appear next.

Figure 4: Web Login screen



3. Enter the username and password (default user name and password is "admin") in Web login screen (as illustrated in Figure 5).

Figure 5: Main Web screen



After a successful login, the MC355-1T/1S media converter can be managed through the available menu options. Please refer to the user manual for more information on the web management menu options.

Note: For security purposes, please change the default password and keep record of the new one after the first login.

Hardware & Password Reset

To reset the IP address to the default IP Address of “192.168.0.100” and reset the login password to default value (default user name and password is admin). Press and hold the hardware reset button on the front panel for about 10 seconds. After the device is rebooted, you can login the management Web interface with the default IP address of 192.168.0.100 and default user name / password (admin).

Figure 6: Reset button

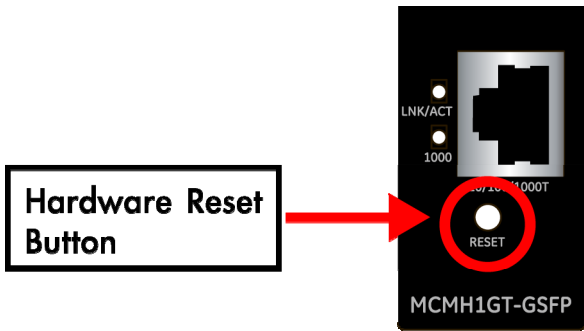

Contacting Technical Support

Contact technical support if you encounter any difficulties during this installation. Please make sure you have the requested diagnostic or log files ready before you contact us by phone or go to www.interlogix.com/customer-support.

Technical Support

Europe, Middle East and Africa

W Select *Contact Us* at www.utcfssecurityproducts.eu

North America

T +1 855.286.8889

E techsupport@interlogix.com

Australia

E techsupport@interlogix.au
