

TruVision Wedge Dome Back Box and Dual View Mount Installation Guide

Product overview

This is the installation guide for the following TruVision wedge camera models:

- TVW-DVM (dual view mount) (use with TVD-PPB)
- TVW-AWB-1 (angled back box for outdoor application)
- TVW-AWB-2 (angled back box for indoor application)
- TVW-2G-AD (Adapter plate for wedge camera with 2-gang box)

Product and package contents

Check the package and contents for visible damage. If any components are damaged or missing, do not attempt to use the unit; contact the supplier immediately. If the unit is returned, it must be shipped back in its original packaging.

TVW-DVM dual view mount

The TVW-DVM dual view mount (purchased separately) allows you to install two panoramic cameras on a single mount. You then obtain a view of the surrounding area without requiring a complex integration effort when connecting to your storage device or video management system (VMS).

Camera mount:

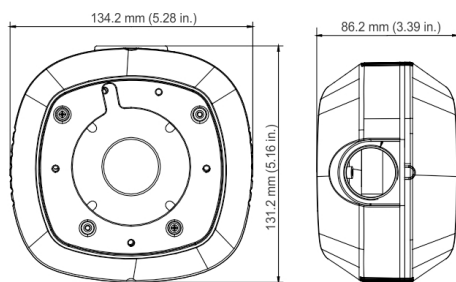

Tube adapter (30 x 12 mm):

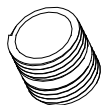

Conduit cover/plug:



Template A:

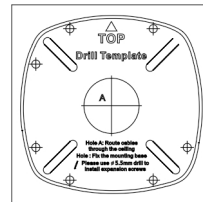

Template B:

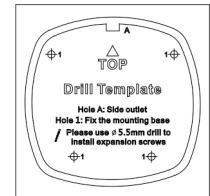

Screw 3 x 10 m (5 pcs m):

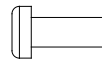

Screw (10 pcs):

Drywall anchor 7.5 x 24.5 mm



M4 screw 4 x 25 mm



Screw 3 x 8 mm (2 pcs):



Screw 4 x 10 mm (5 pcs):

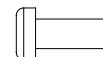

Rubber ring:

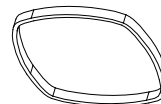
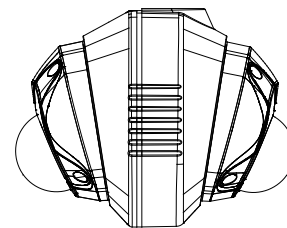

Figure 1: Cameras attached using the dual view mount



TVW-AWB-1 outdoor angled back box

The TVW-AWB-1 outdoor angled back box (purchased separately) is weather resistant and includes a G1 threaded conduit access and plug. It conceals the interconnect cables and eliminates the blind area below the camera when the camera is installed on a wall.

Camera back box:

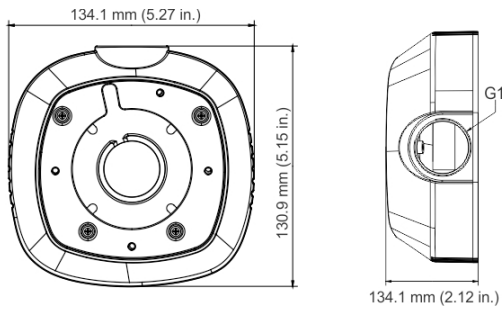

Camera back box:

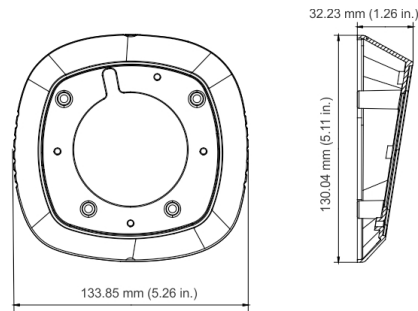

Tube adapter (30 x 12 mm):



Conduit cover/plug:



Template A

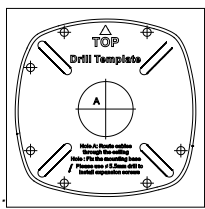

Rubber ring:

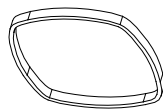

Template B:

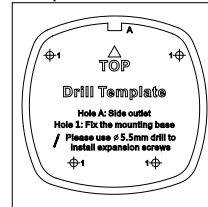

Screw 5 pcs:

Drywall anchor (7.5 x 24.5 mm)



M4 screw (4 x 25 mm)



Screw 3 pcs (4 x 10 mm):



Screw (5 pcs):

Drywall anchor 7.5 x 24.5 mm



M4 screw 4 x 25mm



Screw 3 x 10 mm (5 pcs):

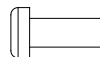

Screw 3 x 8 mm (2 pcs):



Screw 4 x 10 mm (3 pcs):



Figure 3: Camera mounted on an indoor back box

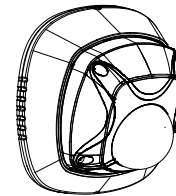

TVW-2G-AD adapter plate

The TVW-2G-AD adapter plate (purchased separately) allows you to attach the panoramic wedge camera to a standard 4-inch 2 gang box.

Camera adapter plate:

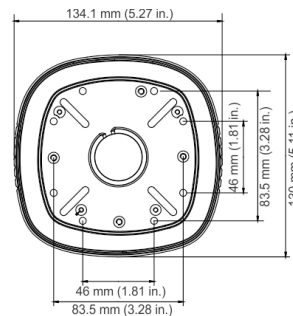
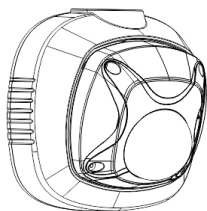

Figure 2: Camera mounted on an outdoor back box



TVW-AWB-2 indoor angled back box

The TVW-AWB-2 indoor angled back box (purchased separately) conceals the interconnected cables and eliminates the blind area below the camera when the camera is installed on a wall.

Template A:

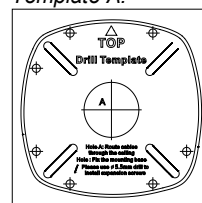

Rubber ring:

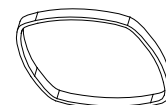

Screw 5 pcs:

Drywall anchor (7.5 x 24.5 mm)

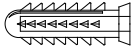

M4 screw (4 x 25 mm)



Screw 4 x 10 mm (3 pcs):



Screw 3 x 8 mm (2 pcs):

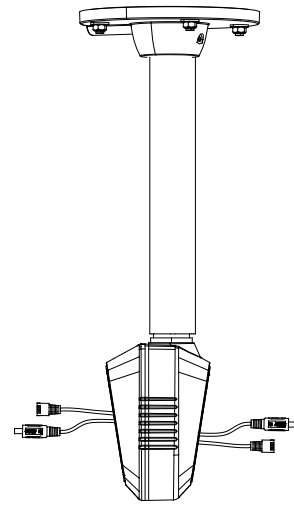
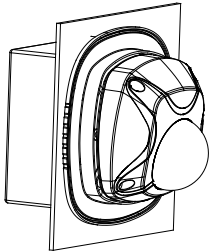

Figure 4: Wedge camera attached to a 2 gang box



Installation

To mount two wedge cameras on a dual view mount:

1. Attach the TVW-DVM dual view mount to an installed pendant mount tube. An adapter is included in the kit that, if required, can be used to match-up with the threading (G1 male or G1 female) of the pendant mount tube.

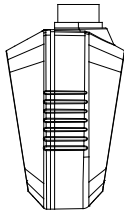

2. Loosen the screws with the tamper-resistant hex wrench (supplied) to remove the camera cover.

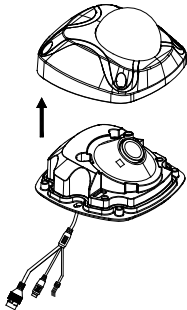

3. Pull the cables through the bracket tube and to both back boxes, connect the cables to cameras and place the connectors and cables into the back boxes.

4. Mount the two cameras on both sides of the TVW-DVM dual view mount.

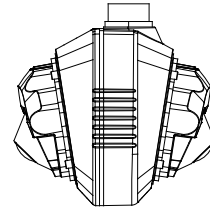

5. Re-attach the camera covers to the cameras.

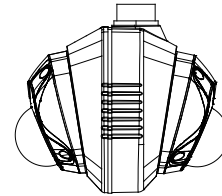

To mount the wedge camera on an outdoor angled back box:

1. Drill the holes for the mounting hardware in the mounting surface using the supplied drill template.

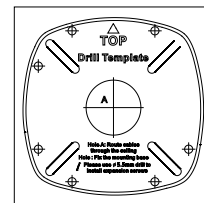

2. Detach the TVW-2G-AD adaptor plate from the back box.

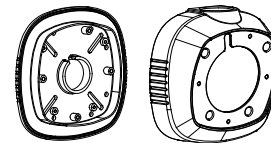

3. Mount the TVW-2G-AD adaptor plate to the mounting surface using the supplied hardware.

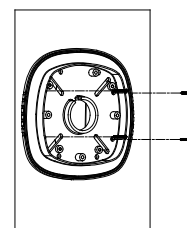

4. Mount the outdoor angled back box to the TVW-2G-AD adaptor plate using the supplied hardware.

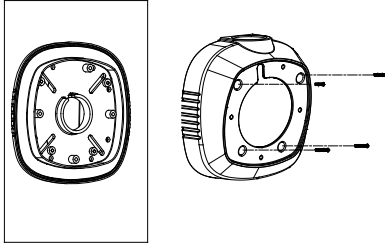

5. Loosen the screws with the tamper-resistant hex wrench (supplied) to remove the camera cover.

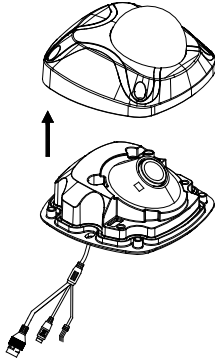

6. Connect the cables, conceal the cables and connectors inside the back box and mount the camera base to the outdoor angled back box.

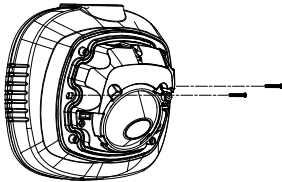

7. Re-attach the dome cover to the camera.

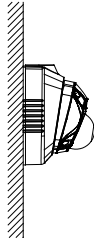

To mount the wedge camera on an indoor angled back box:

1. Drill the holes for the mounting hardware in the mounting surface using the supplied drill template.

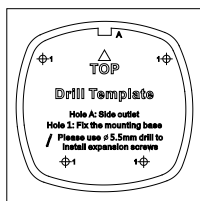

2. Mount the indoor back box to the mounting surface by using the supplied hardware.

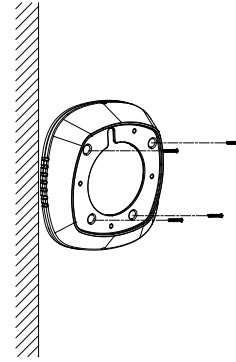

3. Loosen the screws with the tamper-resistant hex wrench (supplied) to remove the camera cover.

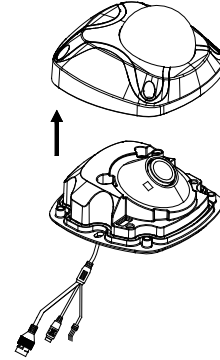

4. Connect the cables, conceal the cables and connectors inside the back box, and mount the camera base to the indoor angled back box.

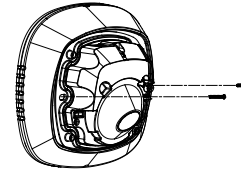

5. Re-attach the dome cover to the camera.

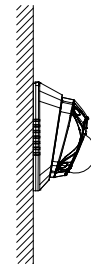

To mount the wedge camera on a 2-gang box:

1. Install the 2-gang box (separately purchased) in the wall according to the local applicable codes and regulations

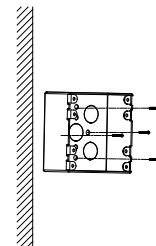

2. Attach the TVW-2G-AD adapter to a pre-installed 2-gang box on wall.

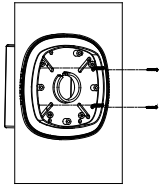

- Attach the enclosed rubber ring to the 2-gang box adapter.

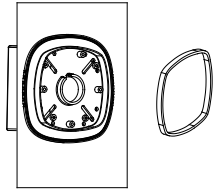

- Loosen the screws with the tamper-resistant hex wrench (supplied) to remove the camera cover.

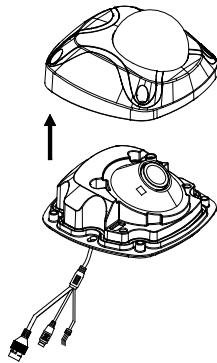

- Connect the cables, conceal the cables and connectors inside the 2-gang box and mount the camera base to the 2-gang box adapter.

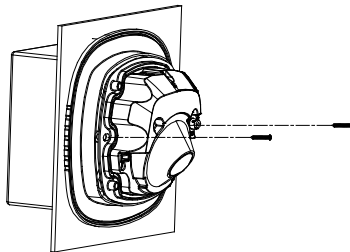

- Re-attach the camera cover to the camera.

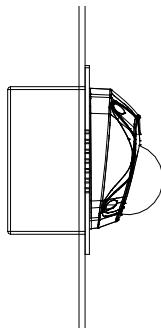

Specifications

TruVision wedge camera bracket and mount

TVW-DVM

Dimensions (L × W × H) 134.2 × 131.2 × 86.2 mm
(5.28 × 5.16 × 3.9 in.)

Weight 422 g (0.93 lb.)

TVW-AWB-1

Dimensions (L × W × H) 134.1 × 130.9 × 54 mm
(5.27 × 5.15 × 2.12 in.)

Weight 321 g (0.71 lb.)

TVW-AWB-2

Dimensions (L × W × H) 133.9 × 130 × 32.2 mm
(5.27 × 5.12 × 1.26 in.)

Weight 101 g (0.22 lb.)

TVW-2G-AD

Dimensions (L × W × H) 134.1 × 130 × 13.5 mm
(5.27 × 5.12 × 0.53 in.)

Weight 129 g (0.28 lb.)

Regulatory information

Manufacturer Interlogix.
2955 Red Hill Avenue, Costa Mesa, CA 92626
5923, USA
Authorized EU manufacturing representative:
UTC Fire & Security B.V.
Kelvinstraat 7, 6003 DH Weert, The Netherlands

Trademarks and patents The trade names used in this document may be trademarks or registered trademarks of the manufacturers or vendors of the respective products.

Contact information

For contact information, see www.interlogix.com or www.utcssecurityproducts.eu.